

**INSTRUCTIONS FOR USE
OF AN UPRIGHT FREEZER**

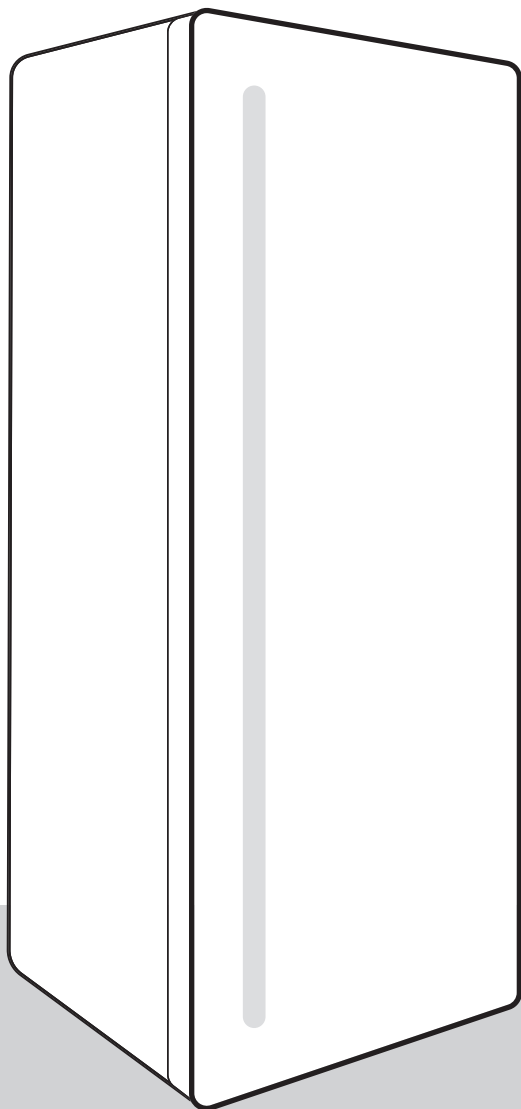

We thank you for the confidence you have shown by purchasing our appliance which is designed to simplify your life. To make the use of the product easier, we have supplied detailed instructions for use, and installation instructions supplied on a separate sheet. The instructions should allow you to learn about your new appliance as quickly as possible.

We wish you find a lot of pleasure in its use.

Please visit our website where you can enter your appliance model number, indicated on the rating plate or the warranty sheet, to find detailed description of your appliance, tips on use, troubleshooting, service information, instructions for use etc.



<http://www.gorenje.com>

Link to the EU EPREL database

The QR code on the energy label supplied with the appliance provides a web link to the registration of this appliance in the EU EPREL database. Keep the energy label for reference together with the user manual and all other documents provided with this appliance. It is possible to find information related to the performance of the product in the EU EPREL database using the link <https://eprel.ec.europa.eu> and the model name and product number that you can find on the rating plate of the appliance. For more detailed information about the energy label, visit www.theenergylabel.eu.

The appliance is intended solely for household use.

The freezer is intended for freezing fresh food and for long-term storage of frozen food (up to one year, depending on the type of food).

The following symbols are used throughout the manual and they have the following meanings:



INFORMATION!

Information, advice, tip, or recommendation



WARNING!

Warning – general danger



ELECTRIC SHOCK!

Warning – danger of electric shock



DANGER OF FIRE!

Warning – danger of fire

Contents

Important notes and precautions	4
Before using the appliance for the first time	4
Important safety instructions	4
Important information on the use of appliance	7
Environment protection	9
Advice for saving power with refrigeration appliances	9
Installation and connection	10
Selecting the room	10
Appliance placement	11
Connecting the appliance	12
Reversing the door opening direction	13
Description of the appliance	17
Operating the appliance	18
Switching the appliance on/off	19
Adjusting the temperature in the appliance	19
Control unit/display standby mode	19
Intensive freezing (super freeze) function	19
Eco function	20
Child Lock	21
High temperature alarm	21
Open door alarm	21
Power outage/power supply failure alarm	22
Appliance interior equipment	23
Ice cube tray *	23
Pull-out tray (EasyTray) *	23
Freezing and storing frozen food	23
Freezing procedure	23
Important warnings on freezing	24
Storing industrially frozen food	24
Frozen food storage time	24
Thawing frozen food	24
Defrosting the appliance	26
Defrosting a NoFrost freezer	26
Manual defrosting of the NoFrost freezer	26
Cleaning the appliance	27
Troubleshooting	28
Information about appliance noise	29

Important notes and precautions

Before using the appliance for the first time

Before connecting the appliance to the power mains, please read carefully the instructions for use which describe the appliance and its correct and safe use. The instructions apply to several appliance types/models; thus, settings or equipment may be described herein which is not available in your appliance. We recommend saving this instruction manual for future reference and attach it to the appliance if it is sold in the future.

Check for any damage or irregularities on your appliance. If you find your appliance is damaged, notify the retailer from which you have purchased the appliance.

Before connecting the appliance to the power mains, let the appliance rest in a vertical position for a minimum of 2 hours. This will reduce the possibility of operation faults due to the effect of transport on the cooling system.

Important safety instructions



DANGER OF FIRE!

WARNING! Risk of fire/flammable materials.

The appliance must be connected to the power mains and grounded in compliance with the effective standards and regulations.

WARNING! Do not locate multiple portable socket-outlets or portable power supplies at the rear of the appliance.

Before cleaning the appliance, unplug it from the power mains (unplug the power cord from the wall outlet).

ELECTRIC SHOCK!

WARNING! If the supply cord is damaged, it must be replaced by the manufacturer, its service agent or similarly qualified persons in order to avoid a hazard.



ELECTRIC SHOCK!

WARNING! When positioning the appliance, ensure the supply cord is not trapped or damaged.



ELECTRIC SHOCK!

If LED lighting does not work, call a service technician. Do not attempt a repair of the LED lighting yourself, as there is danger of contact with high voltage!



WARNING!

WARNING! Do not use electrical appliances inside the food storage compartments of the appliance, unless they are of the type recommended by the manufacturer.



WARNING!

WARNING! Do not use mechanical devices or other means to accelerate the defrosting process, other than those recommended by the manufacturer.



WARNING!

WARNING! To avoid any hazard resulting from poor stability of the appliance, make sure it is installed as instructed.

Freeze burn hazard

To avoid freeze burn, never put frozen food in your mouth and do not touch frozen food.

Safety of children and vulnerable persons

The appliance is not intended for use by persons (including children) with reduced physical, sensory or mental capabilities, or lack of experience and knowledge, unless they have been given supervision or instruction concerning use of the appliance by a person responsible for their safety.

Children should be supervised to ensure that they do not play with the appliance.

Cleaning and user maintenance shall not be made by children without supervision.

Remove the packaging intended to protect the appliance or particular parts during transport and keep it outside the reach of children. It presents danger of injury or suffocation.

When removing a used appliance, disconnect the power cord, remove the door, and leave the shelves in the appliance. This will prevent children from locking themselves in the appliance.

For European markets only

This appliance can be used by children aged from 8 years and above and persons with reduced physical, sensory or mental capabilities or lack of experience and knowledge if they have been given supervision or instruction concerning use of the appliance in a safe way and understand the hazards involved.

Children shall not play with the appliance.

Cleaning and user maintenance shall not be made by children without supervision.

Children aged from 3 to 8 years are allowed to load and unload refrigerating appliances.

Warning regarding the refrigerant

The appliance contains a small amount of an environmentally friendly yet flammable gas R600a. Make sure that no parts of the cooling system are damaged. A gas leak is not hazardous to the environment, but it could cause eye injury or fire.

In case of a gas leak, ventilate the room thoroughly, disconnect the appliance from the power mains, and call a service technician.

Important information on the use of appliance



WARNING! This appliance is intended to be used in household and similar applications such as:

- staff kitchen areas in shops, offices and other working environments;
- farm houses and by clients in hotels, motels and other residential type environments;
- bed and breakfast type environments;
- catering and similar non-retail applications.

⚠ WARNING!

WARNING! Keep ventilation openings, in the appliance enclosure or in the built-in structure, clear of obstruction.

The appliance may not be used outdoors and it may not be exposed to rain.

Do not store explosive substances such as aerosol cans with a flammable propellant in this appliance.

If the appliance will be out of use for an extended period of time, switch it off using the relevant button, and unplug it from the power mains. Empty the appliance, defrost it, clean it, and leave the door ajar.

In case of an error or power supply failure, do not open the freezer compartment unless the freezer has not operated for over 16 hours. After this period, use the frozen food or provide sufficient cooling (e.g. a replacement appliance).

Technical information on the appliance

Rating plate can be found in the appliance interior. It indicates data on voltage, gross and net volume, type and amount of refrigerant, and information on the climate classes.

If the language on the rating plate is not the language of your choice or the language of your country, replace it with the one supplied.

⚠ WARNING!

WARNING! Do not damage the refrigerant circuit. This will also prevent pollution.

Environment protection

Packaging is made of environmentally friendly materials that can be recycled, disposed of, or destroyed without any hazard to the environment.

Removing an obsolete appliance

To protect the environment, take the obsolete appliance to an authorized home appliance collection centre.

Before doing so, do the following:

- disconnect the appliance from the power mains;
- do not allow children to play with the appliance.



■ The symbol on the product or its packaging indicates that the product should not be treated as normal household waste. The product should be taken to an authorized collection centre for waste electric and electronic equipment processing. Correct disposal of the product will help prevent any negative effects on the environment and health of people which could occur in case of incorrect product removal. For detailed information on removal and processing of the product, please contact the relevant municipal body in charge of waste management, your waste disposal service, or the store where you bought the product.

Advice for saving power with refrigeration appliances

- Install the appliance as specified in the instruction manual.
- Do not open the door more often than necessary.
- Occasionally make sure air circulation underneath the appliance is unobstructed.
- If the gasket is damaged or does not provide a perfect seal for any reason, have it replaced as soon as possible.
- Store the food in tightly sealed containers or appropriate packaging.
- Before placing the food in the refrigerator, allow it to cool down to room temperature.
- Defrost frozen food in the refrigerator compartment.
- To make use of the entire freezer compartment interior volume, remove some of the drawers as described in the instruction manual.
- Make sure the layout of shelves in the compartment is uniform and that the food is placed so that the air can freely circulate in the appliance interior (observe the recommended placement of food as described in the instructions).

Installation and connection

Selecting the room

- Install the appliance in a dry and well ventilated room. The appliance will operate correctly if the environment temperature is in the interval specified in the table. The appliance class is indicated on the rating plate / label with the basic information on the appliance.

Description	Class	Ambient temperature range °C	Relative humidity
Extended temperate	SN	+10 to +32	≤75%
Temperate	N	+16 to +32	
Subtropical	ST	+16 to +38	
Tropical	T	+16 to +43	



INFORMATION!

This appliance functions at temperatures down to -15 °C, if you carefully observe the instructions below.



INFORMATION!

This appliance is not intended to be used as a build-in appliance.

- After the installation, the appliance mains plug should be accessible!
- Do not place the appliance near appliances or devices radiating heat, such as a cooker, a stove, a radiator, water heater etc., and do not expose it to direct sunlight. The appliance should stand at least 3 cm away from an electric or gas cooker or at least 30 cm away from an oil or solid fuel stove. If the distance between such source of heat and the appliance is smaller, use an insulating panel.

Note: Place the appliance in a sufficiently large room. There should be at least 1 m³ of space per 8 grams of refrigerant. Amount of refrigerant is indicated on the rating plate in the appliance interior.

Appliance placement

Appliance installation should be carried out by at least two persons to avoid any personal injury or damage to the appliance.

- The appliance must stand level or tilted slightly to the back. It should be stable and placed on a solid base. At the front, the appliance is fitted with two adjustable feet that can be used to level the appliance. At the rear side, casters allow for easier installation of the appliance (only with some models).

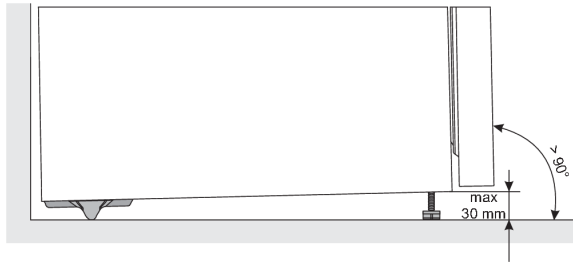

- After you have levelled the appliance using the adjustable feet, adjust the additional foot for extra stability of the appliance.
- Do not expose the appliance to direct sunlight and do not place it near sources of heat. If this cannot be avoided, install an insulation panel.
- The appliance is intended for free-standing installation. To reach the rated/minimum power consumption, always provide 50 mm of clearance between the wall and the back of the appliance, and above the appliance. Also allow adequate air circulation on either side of the appliance and above it.
- The appliance can also be placed adjacent to or between kitchen cabinets or cupboards, or adjacent to a wall. In case of such placement, the appliance will operate flawlessly; however, power consumption could increase. Observe the minimum clearance above and behind the appliance, as indicated in the figure.

- Take into account the space or clearance required to open the appliance door, in order to allow the drawers and shelves to be pulled out or removed (see installation diagram).

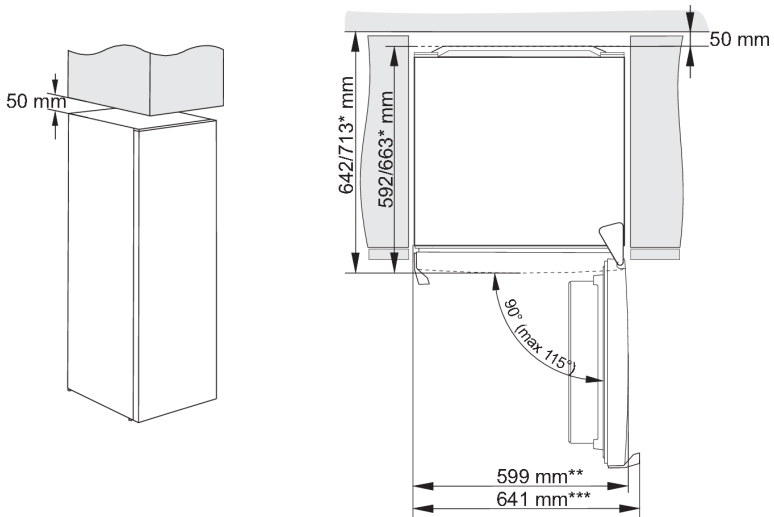

* depending on the model

** model with integrated handle

*** model with external/protruding handle

INFORMATION!

Note: When placing the appliance on a plinth with a depth of less than 625 mm, it is recommended that you purchase and install a security kit.

Code for ordering the set: 890399.

Connecting the appliance

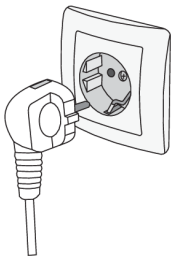





- Connect the appliance to the power mains using the power cord. The wall outlet should be fitted with a ground contact (safety socket). Nominal voltage and frequency are indicated on the rating plate/label with basic information on the appliance.
- The appliance must be connected to the power mains and grounded in compliance with the effective standards and regulations. The appliance will withstand short-term deviations from the nominal voltage, but not more than +/- 6%.

Reversing the door opening direction

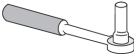
The direction in which the appliance door opens can be reversed.

Note: Disconnect the appliance from the power mains before reversing the door opening direction.

Tools required:	
	Socket wrench No. 8,
	Cross-point screwdriver
	Flat screwdriver
	Spanner No. 8

Note:

- If the appliance has to be tilted to allow access to parts on the bottom, ask another person for assistance or gently place the appliance on some soft padding to prevent damaging it. To reverse the opening direction, proceed as follows.

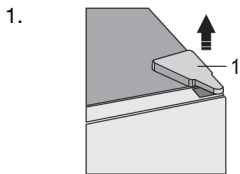

Remove the top hinge cap (1). Be particularly careful not to damage the connector (A). Unplug the connector (A).

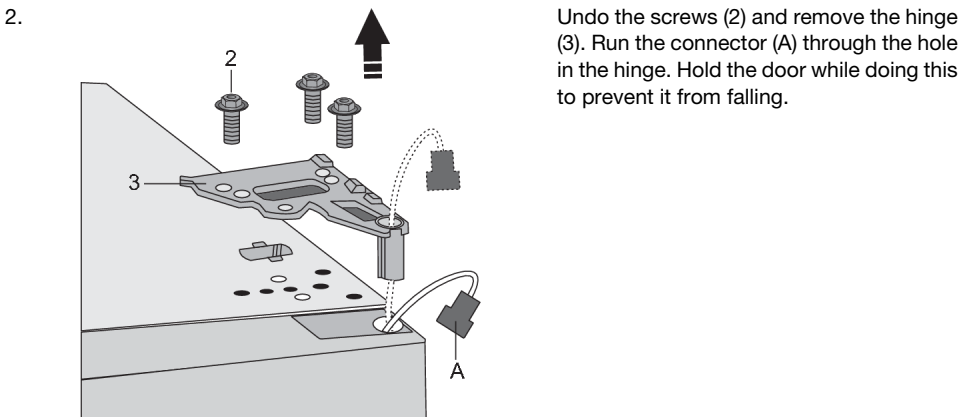
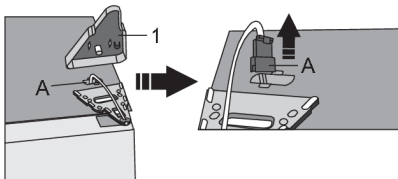

Undo the screws (2) and remove the hinge (3). Run the connector (A) through the hole in the hinge. Hold the door while doing this to prevent it from falling.

3.

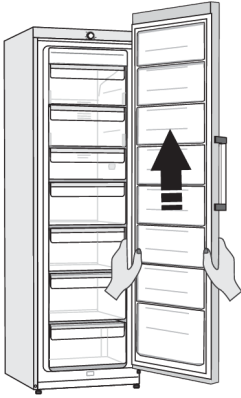

Remove the door from the bottom hinge by carefully lifting the door straight up. Lay the door onto a smooth surface.

4.

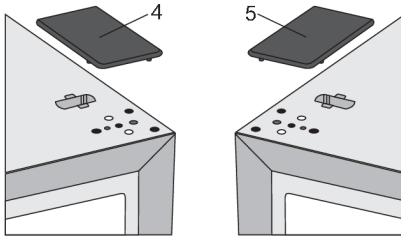

Take the (right) cap/cover (4) from the bag and place it on the spot from which the top hinge was removed. Remove and save the cap/cover from the other side (5) to which the hinge will be relocated.

5.

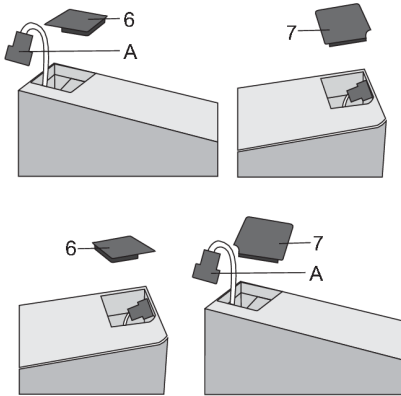

Remove the cap (6) from the left side of the door and take the connector (A) from the space underneath the cap. Then, remove the cap (7) from the right side of the door. Place the cap (7) on the left side of the door and place the cap (6) on the right side of the door.

6.

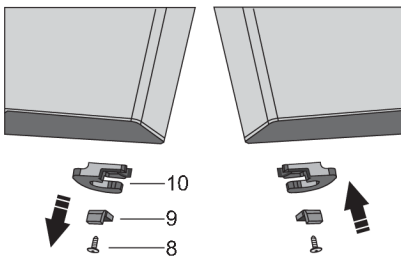

Undo the screw (8) and remove the door retainer (10) and the door stop (9). Then, use a screw (8) to install the door retainer supplied in the bag, and the door stop (9). Keep the door retainer (10) in case you need it later.

7. Tilt the appliance backwards and remove the adjustable foot (11).

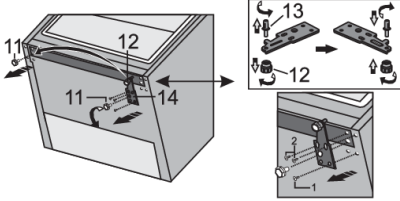
8.  Undo the three screws on the bottom hinge (14) and remove it. Remove the extra foot (12) from the bottom hinge pin (13). Unscrew the pin (13) from the bottom hinge and screw it onto the opposite side of the hinge, complete with the extra foot (12).

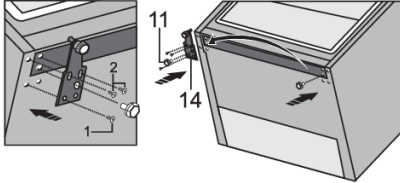
9.  Attach the hinge (14) onto the opposite side using the screws. The screws should be attached in the order shown in the figure below. First, tighten the screw 1, followed by screws 2. Then, screw on the adjustable feet (11).

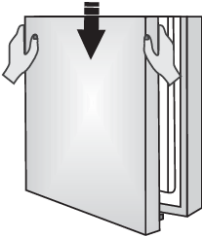
10.  Correctly position the top door, run the connector (A) through the hole in the top hinge (3) and use the screws (2) to attach it. Hold the door in place while positioning it. Connect the connector (A).

11.  Replace the upper hinge cap (1).

12. Open the door and replace the door racks/shelves. Close the door again.

12. Open the door and replace the door racks/shelves. Close the door again.

Note: If your model has a handle, then move it to the opposite side by following the instructions below.

Remove the caps (1) and undo the two screws (2) as shown in the figure. Rotate the handle (3) by 180° and replace it on the opposite side. Then, fasten the screws (2) and replace the caps (1).



Replacement of the hinged handle (only with some models)

Note: If your model has a hinged handle, then move it to the opposite side by following the instructions below:



INFORMATION!

To replace a hinged handle, the door must be open.

1. Remove the cover plates (1) as shown in the figure.
2. Undo the four screws (2).
3. Rotate the handle (3) by 180° and replace it on the opposite side. Then, fasten the screws (2) and replace the cover plates (1).

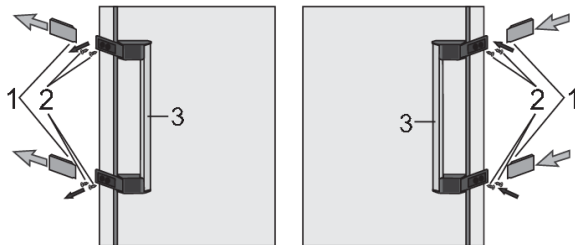

Description of the appliance

Appliance interior equipment may change according to the appliance model.

This product contains a light source of energy efficiency class E.

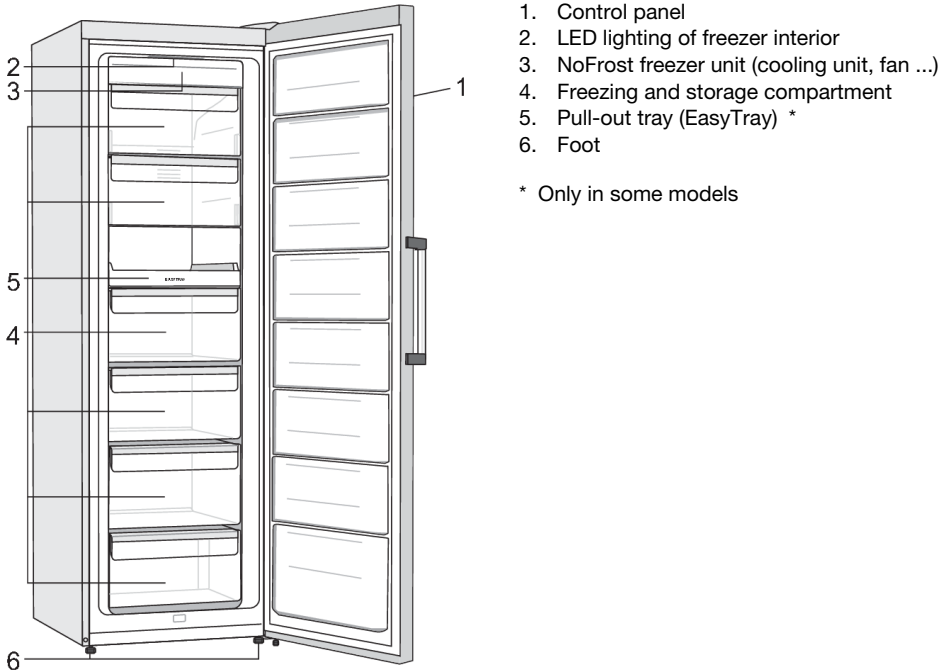

* Only in some models

- The drawers are fitted with a system that prevents them from being unintentionally pulled out. To remove a drawer from the appliance, pull it out as far as it will go, then lift at the front and pull out completely.
- Fan (concealed in the freezer unit) ensures more even temperature distribution. It does not operate when the freezer door is open and when the compressor is still.

Operating the appliance

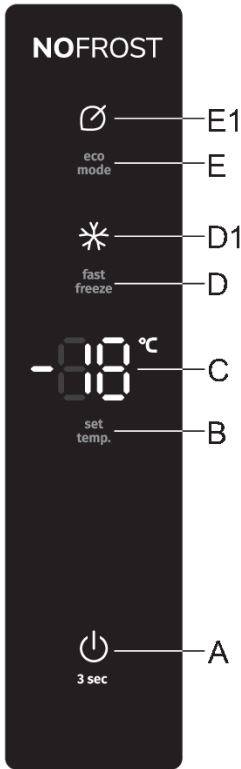

- A** Appliance on/off key
- B** Temperature setting key
- C** Set temperature display
- D** Intensive freezing (fast freeze) on/off key
- D1** Intensive freezing (fast freeze) function indicator
- E** Eco function on/off key
- E1** Eco function indicator

Switching the appliance on/off

When you connect the appliance to the power mains for the first time, the appliance will be in standby mode (switched off, but powered).



Switching on the appliance: to switch on the appliance, press the **A** key. A beep will be sounded, and temperature will be displayed on the display unit **C**.

Switching off the appliance: switch off the appliance by pressing the **A** key and holding it (for 3 seconds). The appliance will switch to standby mode (it remains powered).

Adjusting the temperature in the appliance

INFORMATION!

- The factory default setting is the recommended temperature of -18°C .
- After the appliance is switched on, it may take several hours until the set temperature is reached. Do not place any food into the appliance before the temperature drops to the selected setting.

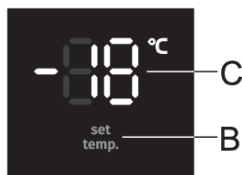

Use the **B** key to set the temperature in the appliance.

- Temperature in the appliance can be set in the range from -16°C to -24°C .
- Each time the **B** key is pressed, the temperature is increased by 1°C . Three seconds after the most recent key is pressed, the current setting is automatically stored as the most recent temperature setting of the appliance.
- Recommended temperature setting is -18°C .

Control unit/display standby mode

INFORMATION!

30 seconds after the most recent key is pressed, the control unit/display switches to standby mode. All indicators and displays on the control unit will be switched off. If any of the extra functions is activated, its indicator will remain lit while the appliance is in standby mode, too.

To switch back from the standby mode: briefly press the **A** key or open the door. If any of the extra functions are activated, you may also press the key for activating or deactivating that extra function in order to wake up the appliance from the standby mode.

Intensive freezing (super freeze) function

INFORMATION!

Use this setting after switching on the appliance for the first time, before cleaning, or before inserting a large amount of food.

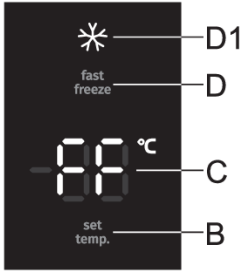

To activate: press the **D** key to activate intensive freezing (fast freeze).

You will hear a beep,  will light up on the display unit, and **FF** will light up on the display unit **C**.

To deactivate: to deactivate the intensive freezing (fast freeze) function, press the **D** key again. You will hear a beep and  will no longer be lit up. If the function is not deactivated manually, it will be deactivated automatically after approximately two days.

 **INFORMATION!**

When the intensive freezing (fast freeze) function is activated, the appliance will operate with maximum power. During this time, operation may be temporarily somewhat louder.

Eco function

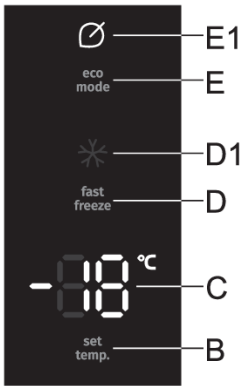

To activate: to activate the function **eco**, briefly press the **E** key.  will light up. When this function is activated, the appliance operates under optimum settings.

To deactivate: to deactivate the **Eco** function, again briefly press the **E** key. The temperature will return to the most recent setting.

The **eco** function will also be deactivated when you use the **B** key to change the temperature setting or when you activate any of the other extra functions.

Child Lock

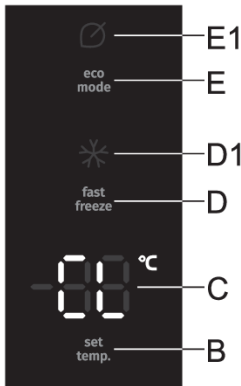

To activate: to activate the child lock, press and hold (for 3 seconds) the **E** key. A beep will be sounded, and **CL** will briefly appear on the **B** display.

The function will lock all keys except the **E** key.

To deactivate: to deactivate the function, press the **E** key again.

In case of a power supply failure or outage, the function will be reactivated.

High temperature alarm

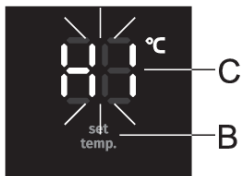

If the temperature inside the appliance is too high, acoustic alarm will be activated (intermittent tone) and **HI** will flash on the display unit.

- Every time the appliance is switched on with the **A** key, there is a 24-hour delay in high temperature alarm operation. If the appliance does not reach the sufficiently low temperature in this period, the alarm will be activated.

Switching off the alarm:

- Acknowledge and turn off the acoustic alarm by pressing any key. As soon as you press any key, the alarm will be silenced, and the highest measured temperature in the appliance will appear on the display unit **C**. When you press a key the second time, the currently set temperature will flash on the **C** display unit. The temperature indication will continue to flash until the actual temperature in the appliance drops to below the alarm level.
- When the appliance reaches an adequate/sufficiently low temperature, then the temperature display will stop flashing and it will be lit continuously.
- If you do not acknowledge and switch off the acoustic alarm, then it will be activated every hour for approximately 15 minutes.

Open door alarm

If the door is open for too long, an acoustic alarm (repetitive beep) will be activated. If the alarm is not switched off manually, it will be sounded for 10 minutes. The appliance will continue to operate as if the door was closed.

To switch off the alarm: to switch off the alarm, close the appliance door.



INFORMATION!

If you switch off the alarm by pressing any key, the alarm will be reactivated in 4 minutes if the door is still open.



INFORMATION!

If you leave the door open for more than 10 minutes, the alarm will no longer be sounded. Appliance operation will switch to safe mode in order to provide sufficient cooling and prevent food spoilage despite the open door.

Power outage/power supply failure alarm

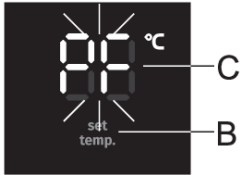

If the temperature in the appliance increased to alarm level during a power outage (power supply failure), then the power failure alarm will be activated when power supply is restored. Acoustic alarm will be sounded, and **PF** will flash on the display unit **C**.

Acknowledge and turn off the acoustic alarm by pressing any key. The highest measured temperature appears on the display unit **C**.

When you press any key again, the power failure (outage) alarm is finally deactivated, and the set temperature will appear on the **C** display unit.

If the high temperature alarm is activated at the same time, it will operate as described in the chapter High temperature alarm, after you have deactivated the power supply failure alarm.

Appliance interior equipment

(* Equipment depends on the model)

Ice cube tray *

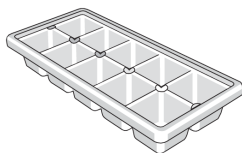

To make ice cubes, fill the tray with water and lay it horizontally in the freezer.

Pull-out tray (EasyTray) *

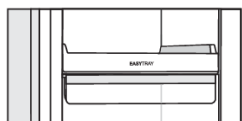

Some models have a pull-out tray instead of a drawer. The pull-out tray improves the view and allows easy access to frozen food.

Freezing and storing frozen food

Freezing procedure



INFORMATION!

Maximum amount of fresh food that may be inserted at once is specified on the appliance rating plate. If the amount of food to be frozen exceeds the indicated amount, the quality of freezing will be inferior; in addition, the quality of the food already frozen will deteriorate.

- To make use of the entire freezer volume, remove all drawers.
- Activate the super freeze function 24 hours before freezing fresh food:
 - press the **D** key until the symbol  lights up.

Make sure the fresh food is not in contact with the food that is already frozen.

- When freezing smaller amounts of food (1-2 kilograms), activating the super freeze function is not required.

Important warnings on freezing



INFORMATION!

Only use the freezer to freeze food appropriate for freezing. Always use quality and fresh food.

Select the most suitable packaging for the food and use the packaging correctly.

Make sure the packaging is air and water tight so that the food does not dry out and lose its vitamins.

Indicate the type of food, amount, and date of freezing on the packaging.

It is important that the food freezes quickly. Therefore, smaller packages are recommended. Refrigerate the food before freezing.

Storing industrially frozen food

- When storing and using frozen food, observe the manufacturer's instructions. Temperature and expiry date are indicated on the packaging.
- Only choose food with undamaged packaging, stored in freezers at temperatures of -18°C or lower.
- Do not purchase food covered in frost as this indicates it has been partly thawed several times and that it is of inferior quality.
- Protect the food from thawing during transport. In case of an increase in temperature, storage time will be shorter and quality will deteriorate.

Frozen food storage time

Recommended storage time in the freezer

Type of food	Storage life
Fruit, beef	from 10 to 12 months
Vegetables, veal, poultry	from 8 to 10 months
Venison	from 6 to 8 months
Pork	from 4 to 6 months
Finely chopped or minced meat	4 months
Bread, pastas, cooked dishes, whitefish	3 months
Offal	2 months
Smoked sausage, bluefish	1 month

Thawing frozen food

- Thawing is an important step in storing food preserved by freezing. Food must be thawed in the correct way.
- Suitable methods of thawing food are:
 - in the refrigerator;
 - in cold water;
 - in a microwave or conventional oven with a suitable thaw program.
- Some frozen products can be prepared without needing to thaw them first. The manufacturer will state this on the packaging.
- The food needs to be packed in small portions. In this way the food thaws faster.

- Use partially or completely thawed food as quickly as possible. The bacteria in thawed food are reactivated and the food will spoil rapidly. This applies in particular to fruit, vegetables and ready-made food.
- Do not refreeze partially or completely thawed food.

Defrosting the appliance

Defrosting a NoFrost freezer

- The NoFrost freezer will defrost automatically. Any frost layer that may build up occasionally will disappear automatically.

Manual defrosting of the NoFrost freezer

- A layer of frost could build up on the appliance walls despite the NoFrost feature. This is usually a result of abnormal use of the appliance, such as too frequent door opening, leaving the door open for too long, poor door seal etc.

In such case, the freezer can be defrosted manually, according to the following procedure:

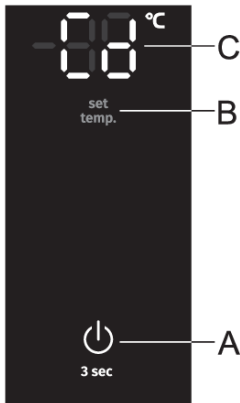

- Simultaneously press and hold the **A** and **B** key. **Cd** will appear on the display unit **C**.
- When the defrosting process is completed, the function will be deactivated automatically. Set temperature will be indicated on display unit **C**.

Cleaning the appliance



WARNING!

Before cleaning, unplug the appliance from the power mains – switch off the appliance (see chapter Switching the Appliance On/Off) and unplug the power cord from the wall outlet.

- Use a soft cloth to clean all surfaces. Cleaners that contain abrasive substances, acids, or solvents are not suitable for cleaning as they may damage the surface.

Clean the appliance exterior with water or a mild solution of suds.

Lacquer-coated and aluminium surfaces may be cleaned with lukewarm water to which you have added a mild detergent. Use of cleaners with low alcohol content is allowed (e.g. window cleaners). Do not use cleaners containing alcohol for cleaning plastic materials.

Appliance interior can be cleaned with lukewarm water to which you can add some vinegar.

- Do not wash the parts of appliance interior equipment in a dishwasher as they may be damaged.

The condenser unit, located next to the compressor unit on the back of the appliance (only with some models), has to be kept clean, free of dust or other impurities. Occasionally clean it using a soft non-metal brush or a vacuum cleaner.

- After cleaning, switch the appliance back on and insert the food.

Troubleshooting

Problem:	Cause or remedy:
Appliance is connected to the power mains but it does not work.	<ul style="list-style-type: none"> • Make sure there is voltage in the power outlet and that the appliance is switched on.
Cooling system operates continuously for a long period of time:	<ul style="list-style-type: none"> • Too high environment temperature. • Door opened too frequently or too long. • Door not closed correctly (possible impurities on the seal, misaligned door, damaged seal etc.). • Too much fresh food inserted at once.
Appliance sides are warm:	<ul style="list-style-type: none"> • This is normal. There are pipes and tubes installed in the appliance sides, which tend to heat up during appliance operation.
Door is difficult to open:	<ul style="list-style-type: none"> • If you are trying to open the freezer door after just having closed it, this could be difficult to do. As you open the door, some cool air escapes from the appliance and it is replaced by warm air from the environment. When this air is cooled, negative pressure is generated which results in problems as you try to open the door. After a few minutes, the condition is normalized and the door can be easily opened again.
LED lighting does not work:	<ul style="list-style-type: none"> • If LED lighting does not work, call a service technician. • Do not attempt a repair of the LED lighting yourself, as there is danger of contact with high voltage!
HI will appear on the display unit:	<ul style="list-style-type: none"> • Door opened too frequently or too long. • Door not closed correctly (possible impurities on the seal, misaligned door, damaged seal etc.). • An extended power failure. • Too much fresh food inserted at once.
PF will appear on the display unit:	<ul style="list-style-type: none"> • An extended power failure.
E0 or E8 appears on the display unit:	<ul style="list-style-type: none"> • Sensor keys are not responding. Call a service centre for repair. • Until the appliance is repaired by a service technician, the appliance will operate in safe mode. The appliance will automatically maintain the most suitable temperature.
E2 will appear on the display unit:	<ul style="list-style-type: none"> • Temperature sensor error or fault. Call a service centre for repair. Until the appliance is repaired by a service technician, the appliance will operate in safe mode. The appliance will automatically maintain the most suitable temperature.

Table continued from last page

Problem:	Cause or remedy:
E4 appears on the display unit:	<ul style="list-style-type: none">• Compartment fan failure. Call a service centre for repair. The appliance cannot operate normally. Transfer the food to a cool place and switch off the appliance.
E9 appears on the display unit:	<ul style="list-style-type: none">• Door was open for too long. Close the door.• If the door is not open, or if E9 is still displayed 10 minutes after you have closed the door, then there is a door sensor failure. Call a service centre to arrange a repair. The appliance will operate in safe mode until it is repaired. The appliance will automatically preserve the most suitable temperature for each compartment.

If the above tips do not resolve your problem, call the nearest authorized service centre and state the type, model, and serial number indicated on the appliance rating plate or label located in the appliance interior.

Information about appliance noise

Cooling in refrigerator freezers is made possible by a cooling system that also includes a compressor (and a fan with some appliances), which generates some noise. The level of noise depends on installation, proper use, and age of the appliance.

- After connecting the appliance to the power mains, compressor operation, or the sound of flowing liquid, may be somewhat louder. This is not a sign of malfunction and it will not affect the useful life of the appliance. In time, appliance operation and this noise will become quieter.
- Sometimes, unusual or loud noises may appear during appliance operation; these are mostly the result of improper installation:
 - The appliance must stand level and stable on a solid base.
 - The appliance may not be in contact with a wall or adjacent furniture.
 - Make sure the interior equipment sits firmly in its place and that the noise is not caused by rattling cans, bottles or other containers placed next to each other.
- Due to the higher workload on the cooling system when the door is opened more frequently or for a longer time, when a large amount of fresh food is introduced or when intensive freezing or cooling functions are activated, the appliance can temporarily generate more noise.

gorenje

GORENJE gospodinjski aparati, d.o.o. Address: Partizanska 12, 3320 Velenje, Slovenia
Phone: +386 (0)3 899 10 00 Fax: +386 (0)3 899 28 00 www.gorenje.com



880163-a4



We reserve the right to changes that do not affect the appliance functionality.