

DENON

UNIVERSAL AUDIO / VIDEO PLAYER

DBP-A100

Owner's Manual

Manuel de l'Utilisateur

Manual del usuario

※ Button illustrations used in this manual for operation explanation are for the Remote Control Unit.

You can operate the unit using the button of the same name on the front panel of the unit.

※ Les illustrations des boutons présentes dans ce manuel servent à expliquer le fonctionnement de la télécommande.

Vous pouvez contrôler l'appareil à l'aide du bouton portant le même nom sur la façade de l'appareil.

※ Las ilustraciones de los botones utilizadas en este manual con propósitos de explicación son para la unidad del mando a distancia.

Puede operar la unidad utilizando el botón del mismo nombre en el panel delantero de la unidad.

GUI Graphical User Interface

English

Use this manual in combination with the operating guide displayed on the GUI screen.

GUI Menu Operation (☞ page 22)

Français

Utilisez ce manuel en même temps que le guide d'utilisation affiché sur l'écran GUI (Interface graphique).

Fonctionnement du menu de l'interface graphique GUI (☞ page 22)

Español

Utilice este manual conjuntamente con la guía de uso que aparece en la pantalla GUI.

Uso de los menús GUI (☞ página 22)

The serial number of this product may be found on the back of the unit. No others have the same serial number as yours. You should record the number and other vital information here and retain this book as a permanent record of your purchase to aid identification in case of theft.

Date of Purchase	
Dealer Purchase from	
Dealer Address	
Dealer Phone No.	
Model No.	
Serial No.	

SAFETY PRECAUTIONS



CAUTION
RISK OF ELECTRIC SHOCK
DO NOT OPEN



CAUTION:
TO REDUCE THE RISK OF ELECTRIC SHOCK, DO NOT REMOVE COVER (OR BACK). NO USER-SERVICEABLE PARTS INSIDE. REFER SERVICING TO QUALIFIED SERVICE PERSONNEL.

The lightning flash with arrowhead symbol, within an equilateral triangle, is intended to alert the user to the presence of uninsulated "dangerous voltage" within the product's enclosure that may be of sufficient magnitude to constitute a risk of electric shock to persons.

The exclamation point within an equilateral triangle is intended to alert the user to the presence of important operating and maintenance (servicing) instructions in the literature accompanying the appliance.

WARNING:
TO REDUCE THE RISK OF FIRE OR ELECTRIC SHOCK, DO NOT EXPOSE THIS APPLIANCE TO RAIN OR MOISTURE.

CAUTION:
USE OF CONTROLS OR ADJUSTMENTS OR PERFORMANCE OF PROCEDURES OTHER THAN THOSE SPECIFIED HEREIN MAY RESULT IN HAZARDOUS RADIATION EXPOSURE. THIS PRODUCT SHOULD NOT BE ADJUSTED OR REPAIRED BY ANYONE EXCEPT PROPERLY QUALIFIED SERVICE PERSONNEL.

Class 1 (IEC 60825-1:2001)

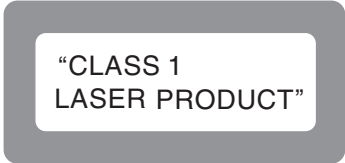

IMPOTANT SAFETY INSTRUCTIONS

1. Read these instructions.
2. Keep these instructions.
3. Heed all warnings.
4. Follow all instructions.
5. Do not use this apparatus near water.
6. Clean only with dry cloth.
7. Do not block any ventilation openings. Install in accordance with the manufacturer's instructions.
8. Do not install near any heat sources such as radiators, heat registers, stoves, or other apparatus (including amplifiers) that produce heat.
9. Do not defeat the safety purpose of the polarized or grounding-type plug. A polarized plug has two blades with one wider than the other. A grounding type plug has two blades and a third grounding prong. The wide blade or the third prong are provided for your safety. If the provided plug does not fit into your outlet, consult an electrician for replacement of the obsolete outlet.
10. Protect the power cord from being walked on or pinched particularly at plugs, convenience receptacles, and the point where they exit from the apparatus.
11. Only use attachments/accessories specified by the manufacturer.
12. Use only with the cart, stand, tripod, bracket, or table specified by the manufacturer, or sold with the apparatus. When a cart is used, use caution when moving the cart/apparatus combination to avoid injury from tip-over.
13. Unplug this apparatus during lightning storms or when unused for long periods of time.
14. Refer all servicing to qualified service personnel. Servicing is required when the apparatus has been damaged in any way, such as power-supply cord or plug is damaged, liquid has been spilled or objects have fallen into the apparatus, the apparatus has been exposed to rain or moisture, does not operate normally, or has been dropped.
15. Batteries shall not be exposed to excessive heat such as sunshine, fire or the like.



CAUTION:

- The ventilation should not be impeded by covering the ventilation openings with items, such as newspapers, tablecloths, curtains, etc.
- No naked flame sources, such as lighted candles, should be placed on the unit.
- Observe and follow local regulations regarding battery disposal.
- Do not expose the unit to dripping or splashing fluids.
- Do not place objects filled with liquids, such as vases, on the unit.

ATTENTION:

- La ventilation ne doit pas être gênée en recouvrant les ouvertures de la ventilation avec des objets tels que journaux, rideaux, tissus, etc.
- Aucune flamme nue, par exemple une bougie, ne doit être placée sur l'appareil.
- Veuillez à respecter les lois en vigueur lorsque vous jetez les piles usagées.
- L'appareil ne doit pas être exposé à l'eau ou à l'humidité.
- Ne pas poser d'objet contenant du liquide, par exemple un vase, sur l'appareil.

PRECAUCIÓN:

- La ventilación no debe quedar obstruida por haberse cubierto las aperturas con objetos como periódicos, manteles, cortinas, etc.
- No debe colocarse sobre el aparato ninguna fuente inflamable sin protección, como velas encendidas.
- A la hora de deshacerse de las pilas, respete la normativa para el cuidado del medio ambiente.
- No exponer el aparato al goteo o salpicaduras cuando se utilice.
- No colocar sobre el aparato objetos llenos de líquido, como jarros.

CAUTION:

To completely disconnect this product from the mains, disconnect the plug from the wall socket outlet. The mains plug is used to completely interrupt the power supply to the unit and must be within easy access by the user.

PRECAUTION:

Pour déconnecter complètement ce produit du courant secteur, débranchez la prise de la prise murale. La prise secteur est utilisée pour couper complètement l'alimentation de l'appareil et l'utilisateur doit pouvoir y accéder facilement.

PRECAUCIÓN:

Para desconectar completamente este producto de la alimentación eléctrica, desconecte el enchufe del enchufe de la pared. El enchufe de la alimentación eléctrica se utiliza para interrumpir por completo el suministro de alimentación eléctrica a la unidad y debe de encontrarse en un lugar al que el usuario tenga fácil acceso.



**FCC INFORMATION
(For US customers)**

1. PRODUCT

This product complies with Part 15 of the FCC Rules. Operation is subject to the following two conditions: (1) this product may not cause harmful interference, and (2) this product must accept any interference received, including interference that may cause undesired operation.

2. IMPORTANT NOTICE: DO NOT MODIFY THIS PRODUCT

This product, when installed as indicated in the instructions contained in this manual, meets FCC requirements. Modification not expressly approved by DENON may void your authority, granted by the FCC, to use the product.

3. NOTE

This product has been tested and found to comply with the limits for a Class B digital device, pursuant to Part 15 of the FCC Rules. These limits are designed to provide reasonable protection against harmful interference in a residential installation.







This product generates, uses and can radiate radio frequency energy and, if not installed and used in accordance with the instructions, may cause harmful interference to radio communications. However, there is no guarantee that interference will not occur in a particular installation. If this product does cause harmful interference to radio or television reception, which can be determined by turning the product OFF and ON, the user is encouraged to try to correct the interference by one or more of the following measures:

- Reorient or relocate the receiving antenna.
- Increase the separation between the equipment and receiver.
- Connect the product into an outlet on a circuit different from that to which the receiver is connected.
- Consult the local retailer authorized to distribute this type of product or an experienced radio/TV technician for help.

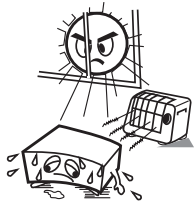
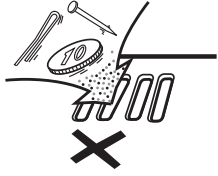
This Class B digital apparatus complies with Canadian ICES-003.

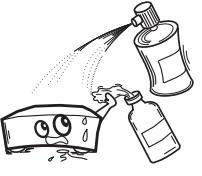
Cet appareil numérique de la classe B est conforme à la norme NMB-003 du Canada.

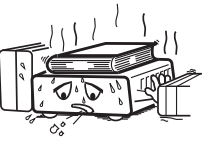
NOTE ON USE / OBSERVATIONS RELATIVES A L'UTILISATION / NOTAS SOBRE EL USO

	<ul style="list-style-type: none"> • Avoid high temperatures. Allow for sufficient heat dispersion when installed in a rack. • Eviter des températures élevées. Tenir compte d'une dispersion de chaleur suffisante lors de l'installation sur une étagère. • Evite altas temperaturas. Permita la suficiente dispersión del calor cuando está instalado en la consola. 	 <ul style="list-style-type: none"> • Do not let foreign objects into the unit. • Ne pas laisser des objets étrangers dans l'appareil. • No deje objetos extraños dentro del equipo.
	<ul style="list-style-type: none"> • Handle the power cord carefully. Hold the plug when unplugging the cord. • Manipuler le cordon d'alimentation avec précaution. Tenir la prise lors du débranchement du cordon. • Maneje el cordón de energía con cuidado. Sostenga el enchufe cuando desconecte el cordón de energía. 	 <ul style="list-style-type: none"> • Do not let insecticides, benzene, and thinner come in contact with the unit. • Ne pas mettre en contact des insecticides, du benzène et un diluant avec l'appareil. • No permita el contacto de insecticidas, gasolina y diluyentes con el equipo.
	<ul style="list-style-type: none"> • Unplug the power cord when not using the unit for long periods of time. • Débrancher le cordon d'alimentation lorsque l'appareil n'est pas utilisé pendant de longues périodes. • Desconecte el cordón de energía cuando no utilice el equipo por mucho tiempo. 	 <ul style="list-style-type: none"> • Never disassemble or modify the unit in any way. • Ne jamais démonter ou modifier l'appareil d'une manière ou d'une autre. • Nunca desarme o modifique el equipo de ninguna manera.
	<p>* (For apparatuses with ventilation holes)</p> <ul style="list-style-type: none"> • Do not obstruct the ventilation holes. • Ne pas obstruer les trous d'aération. • No obstruya los orificios de ventilación. 	

**CAUTIONS ON INSTALLATION
PRÉCAUTIONS D'INSTALLATION
EMPLAZAMIENTO DE LA
INSTALACIÓN**

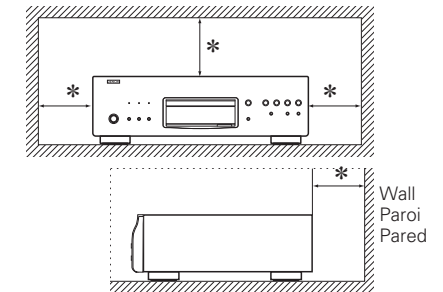

*** For proper heat dispersal, do not install this unit in a confined space, such as a bookcase or similar enclosure.**

- More than 0.1 m (4 in.) is recommended.
- Do not place any other equipment on this unit.

*** Pour permettre la dissipation de chaleur requise, n'installez pas cette unité dans un espace confiné tel qu'une bibliothèque ou un endroit similaire.**

- Une distance de plus de 0.1 m (4 po) est recommandée.
- Ne placez aucun matériel sur cet appareil.

*** Para la dispersión del calor adecuadamente, no instale este equipo en un lugar confinado tal como una librería o unidad similar**

- Se recomienda dejar más de 0.1 m (4 pulg.) alrededor.
- No coloque ningún otro equipo sobre la unidad.

Copyrights / Droits d'auteur / Derechos de Autor

It is prohibited by law to reproduce, broadcast, rent or play discs in public without the consent of the copyright holder.

La reproduction, la diffusion, la location, le prêt ou la lecture publique de ces disques sont interdits sans le consentement du détenteur des droits d'auteur.

De acuerdo con las leyes está prohibido reproducir, emitir, alquilar o interpretar discos en público sin la autorización del propietario de los derechos de autor.

Contents

Features	2
----------	---

Getting Started

Accessories	2
Cautions on Handling	3
Cautions on Installation	3
About Media	3
Playable Media	3
Cautions on Using Media	6
About the Remote Control	7
Inserting the Batteries	7
Operating Range of the Remote Control	7
Remote Control Settings (Remote Control Side)	7
Part Names and Functions	8
Front Panel	8
Display	8
Rear Panel	9
Remote Control	10

Connections

Preparation	12
Connecting Cables	12
1. Home Theater Playback – Playing on a Multi-channel System	13
Using an HDMI Cable to Connect to an AV Amp or Television	13
Required Settings for HDMI Connection	13
Connecting to an AV Amp with No HDMI Audio Input	15
Connecting to a Device with an Analog Multi-channel Audio Input Terminal	16
DENON LINK Connection ① Making a Jitter-free Connection	17
DENON LINK Connection ② Making a Normal Connection	17
Connecting to an AV Amp with No HDMI Video Input	17
2. Playing with a Direct Connection to a TV	18
3. Playing Back 2-Channel Audio	18
Connecting to a Device with Analog 2-channel Audio Input Terminals with a Stereo Pin Plug Cable	18
4. Recording a CD	19
Connecting to a Digital Recording Device	19
5. Using BD-LIVE function or updating the software version of DBP-A100	19
Connecting to a Network	19
Connecting the Power Cord	20
Once Connections are Complete	20
Turning the Power On	20

GUI Menu Setup

Menu Map	21
GUI Menu Operation	22
Examples of GUI Menu Screen Displays	22
Language Setup	23
HDMI Setup	23
Video Setup	24
Audio Setup	25
DENON LINK Setup	28
Pure Direct Setup	28
Ratings	29
Network Setup	29
Display Setup	30
Other Setup	31

Various Settings

Setting the Audio Mode	32
Changing the Playback File Display	32
Making Other Settings	32
Adjusting the Picture Quality (Picture Control)	33

Playback

Introduction	34
Before Playing a Disc	34
Before Playing an SD Memory Card	34
About Playback Information	34
Information Bar Display	34
Media Player Display	35
Playing BDs and DVD-Videos	36
Playing Super Audio CDs	37
Playing CDs	37
Playing DVD-Audio	37
Playing High-Quality Audio (Pure Direct Function)	38
Playing Files	38
Playing Files	39
Screen Display During Playback	40
Operation During Playback	40

Operations Enabled During Playback	41
Pausing	41
Stopping (Resume Function)	41
Skipping to a Desired Chapter/Track/File	41
Finding Specific Sections with Search Modes	42
Memorizing Locations to Replay (Marker Function)	43
Fast-Forward/Fast-Reverse	43
Playing Images Frame by Frame	43
Slow-Forward/Slow-Reverse Playback	43
Playing in Random Order (Random Playback)	44
Playing Repeatedly (Repeat Playback)	44
Playing Repeatedly Between Specified Points (A-B Repeat)	44
Playing in Your Preferred Order (Program Playback)	45
Switching Audio	45
Changing the Subtitles and Subtitle Style	46
Switching the Angle	47
Changing the Brightness of the Display (Dimmer Control)	47
Web control function	47

HDMI Control Function	49
------------------------------	----

Other Information

About DENON LINK	50
About Advanced AL24 Processing	50
About Copyright Protection Technology	50
Trademark Information	50
Language Code List	51
Country Code List	52
Explanation of Terms	53
Index	54

Troubleshooting	55
------------------------	----

Specifications	57
-----------------------	----

Features

A Universal Blu-ray Disc player that plays Super Audio CD and DVD-Audio formats
 📖 page 3, 4 "Playable Media"

Jitter-free transmission thanks to a fusion of DENON LINK 4th generation and HDMI transmission technology
 In addition to multi-channel, digitally balanced transmission of Super Audio CD achieved in 3rd generation, DENON LINK 4th generation provides jitter control functionality during digital signal transmission.(described as 3rd or 4th in the following sentences)
 📖 page 17 "DENON LINK Connection ① Making a Jitter-free Connection"

Equipped with Dolby TrueHD, DTS-HD Master Audio decoder
 Compatible with Linear PCM 192 kHz (one of the BD audio formats) and multi-channel output (6-ch).
 📖 page 16 "Connecting to a Device with an Analog Multi-channel Audio Input Terminal"

Equipped with Advanced AL24 Processing on all channels to enhance HD audio performance
 Detailed picture rendering with minimal distortion; accurate sound location and rich bass.
 Achieves playback more faithful to the original sound on all channels.

GUI equipped for excellent operability and visibility
 📖 page 22 "GUI Menu Operation"

HDMI control ready
 📖 page 49 "HDMI Control Function"

Newly developed "S. V. H. Mechanism" with low center of gravity, vibration damping, quietness and high accuracy

Employs 6-block construction to eliminate both electrical and magnetic interference

Getting Started

Thank you for purchasing this DENON product. To ensure proper operation, please read this owner's manual carefully before using the product.
 After reading the manual be sure to keep it for future reference.

Accessories

Check that the following parts are supplied with the product.

① Owner's manual.....	1
② Service station list.....	1
③ Power cord (Cord length: Approx. 5.9ft/1.8m)	1
④ Remote control (RC-1140)	1
⑤ R6/AA batteries	2
⑥ DENON LINK cable (Cord length: Approx. 4.9ft/1.5 m).....	1
⑦ Audio cable (Cord length: Approx. 4.9ft/1.5m).....	1
⑧ Video cable (Cord length: Approx. 4.9ft/1.5m).....	1
⑨ Warranty (for North America model only).....	1

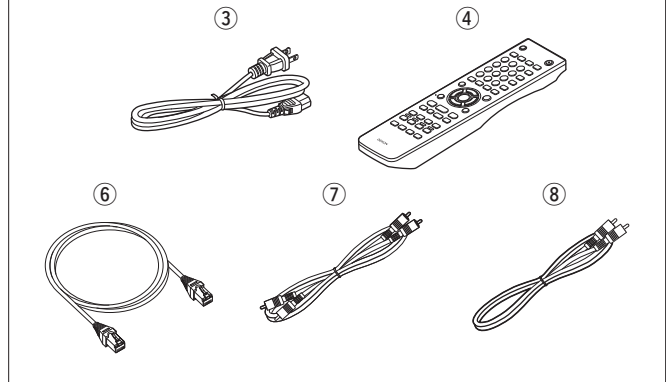

Cautions on Handling

• Before turning the power switch on

Check once again that all connections are correct and that there are no problems with the connection cables.

- Power is supplied to some of the circuitry even when the unit is set to the standby mode. When leaving home for long periods of time, be sure to unplug the power cord from the power outlet.

• Image persistence (image burn-in)

Do not leave still images of the disc menu, DBP-A100 menu, etc., displayed on the TV screen for long periods. This can result in image persistence (image burn-in) on the screen.

• About Condensation

If the DBP-A100 unit is moved from a cold place to a warm place, or installed in a room subject to rapid temperature rise from a heater, etc., condensation may form on parts inside the unit (operating parts and lenses).

If used under this condition, the DBP-A100 will not operate correctly and damage may result. If condensation forms on the unit, leave the DBP-A100 off for 1 to 2 hours before using it again.

• Cautions on using mobile phones

Using a mobile phone near this unit may result in noise. If that occurs, move the mobile phone away from the unit when it is in use.

• Moving the unit

Be sure to remove a disc, turn off the power and unplug the power cord from the power outlet. Next, disconnect the connection cables to other system equipment before moving the unit.

• About Care

- Wipe the cabinet and control panel clean with a soft cloth.
- Follow the instructions when using a chemical cleaner.
- Benzene, paint thinner or other organic solvents, as well as insecticide, may cause material changes and discoloration if brought into contact with the unit, and should, therefore, not be used.

• Proper Ventilation

















If the unit is left in a room full of the smoke from cigarettes, etc., for long periods of time, the surface of the optical pickup may get dirty, preventing it from receiving signals improperly.

- Note that for explanatory purposes the illustrations in these instructions may differ from the actual unit.

About Media

Playable Media

Discs

Playable Media	Playable formats/modes	Playable region codes	Symbols Used in this Owner's Manual
BD-Video *1, *2		-	Discs with 
DVD-Audio *1		-	
DVD-Video *1, *2		-	Include region 
DVD-R, DVD+R		Video mode, AVCHD format	
DVD-RW, DVD+RW	  		
Super Audio CD		-	
CD		-	
CD-R			
CD-RW			

*1 : BD-Video/DVD-Audio/DVD-Video discs may not operate as described in this manual due to menu structure.

*2 : BD players and BD-Video discs, and DVD players and DVD-Video discs each have their region codes (codes assigned for each region). Playback is not possible if the codes do not match.

See overleaf

About Media

NOTE

- A disc may not be accessible or may play incorrectly due to audio and video interruptions, etc., depending on the recording conditions when recorded with a BD recorder or DVD recorder.
- Unfinalised DVD-R/-RW/+R/+RW, and CD-R/-RW discs may not play back. Finalize discs before playing.



The following discs will not play back on this unit.

- BD-RE Ver1.0 (BD disc with cartridge)
- BD-ROM/BD-R/BD-RE discs containing recorded movie, still image, audio, and/or other, files
- BD-R/BD-RE in which BDMV/BD-RE is recorded
- HD DVD
- DVD-RAM
- CDV (Only the audio part can be played)
- CD-G (Only the audio signals can be output)
- Non-standard CD (CD with copy protection, etc.)
- Unauthorised disc (Pirated disc)
- Disc with recording area less than 55 mm in diameter
- Video Single Disc (VSD) / CVD/ Video CD / Super Video CD / CompactDisc-Interactive (CD-I) / Photo CDs

SD Memory Cards

Playable cards	Symbols Used in this Owner's Manual	Playable files (Symbols Used in this Owner's Manual)
SD Memory Cards * 1 (8 MB ~ 2 GB)	SD	MP3 WMA AAC LPCM
SDHC Memory Cards * 1 (4 GB)		JPEG DivX
miniSD Cards * 2 (8 MB ~ 2 GB)		• Data recorded for BD BONUS VIEW use
microSD Cards * 2 (8 MB ~ 2 GB)		• See "Files" in "Playable Media" (page 4) for more information on files.

* 1 : This unit supports SD Memory Cards with FAT16 file systems, and SDHC Memory Cards with FAT32 file systems.

* 2 : MiniSD cards and microSD cards require adapters.

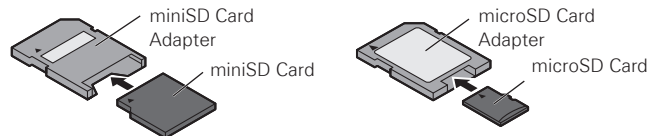

NOTE

- This unit does not support mini SDHC and micro SDHC Memory Cards.
- Insert or remove your SD Memory Card while the power is in standby. If you insert a SD Memory Card while the power is ON, the SD Memory Card may not be read.
- The SD card used for the Bonus View function must have a capacity of 1GB or greater. Also the SD card must be initialized on the DBP-A100 (page 31).

Files

Playable files (Extension)	Playable Media		File specification	Symbols Used in this Owner's Manual
	DVD-R/-RW/+R/+RW CD-R/-RW DVD CD	SD Memory Cards SD		
MP3 (.mp3)	○	○	<ul style="list-style-type: none"> • Sampling frequency: 44.1 kHz, 48 kHz • Bit rate: 64 kbps ~ 320 kbps (144 kbps non-compatible) • Audio type: MPEG 1 Audio Layer 3 	MP3
WMA * (.wma)	○	○	<ul style="list-style-type: none"> • Sampling frequency: 44.1 kHz, 48 kHz • Bit rate: 48 kbps ~ 192 kbps • Audio type: WMA Version 9 	WMA
AAC * (.m4a)	○	○	<ul style="list-style-type: none"> • Sampling frequency: 44.1 kHz, 48 kHz • Bit rate: 64 kbps ~ 192 kbps (Variable Bit Rate non compatible) • Audio type: AAC 	AAC
LPCM (.wav)	○	○	<ul style="list-style-type: none"> • Sampling frequency: 44.1 kHz, 48 kHz • Bit length: 16 bit • Number of channels: 2-ch 	LPCM
JPEG (.jpg/.jpeg)	○	○	<ul style="list-style-type: none"> • Maximum resolution: 4,096 x 4,096 pixels • Minimum resolution: 32 x 32 pixels • Maximum file size: 12 MB 	JPEG
DivX® (.avi/.divx)	○	○	<ul style="list-style-type: none"> • Compatible versions: Up to DivX® 6 • Maximum size: 2 GB 	DivX

* : This unit cannot play files recorded under DRM (Digital Rights Management) other than DivX® files.



- The abovementioned file type may also fail to play back depending on conditions at the time of recording.
- If characters not supported on the menu screen are included in a file name, title, artist name or album title, they will not display correctly.
- JPEG images stored in the progressive format cannot be viewed.

About DivX® Video-on-Demand (VOD)

- When you purchase or rent a DivX® file through the official site of DivX® Video-On-Demand (VOD) services, a DBP-A100 registration code is required. For details, see "DivX® Registration" (page 29).
- A DivX® VOD file recorded with a different code from the DBP-A100 registration code cannot be played back.
- Some DivX® VOD files are restricted to a certain number of playable times. If your DivX® VOD file has such a limit, the number of playable times is displayed on the DivX® VOD display screen.

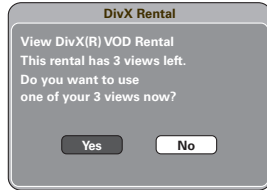
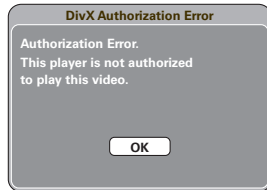

Use to select "Yes" if you want to play a file, or to select "No" if you do not want to play it. Then, press to confirm the selection.

NOTE

- ABOUT DIVX VIDEO: DivX® is a digital video format created by DivX, Inc. This is an official Divx Certified device that plays DivX video. Visit www.divx.com for more information and software tools to convert your files into DivX video.
- ABOUT DIVX VIDEO-ON-DEMAND: This DivX Certified® device must be registered in order to play DivX Video-on-Demand (VOD) content. To generate the registration code, locate the DivX VOD section in the device setup menu. Go to vod.divx.com with this code to complete the registration process and learn more about DivX VOD.

About Discs and Files

BD-Video, DVD-Video

BD/DVD-Video discs are divided into several large sections (titles) and small sections (chapters). These sections are all allotted numbers, called title numbers and chapter numbers.

[Example]

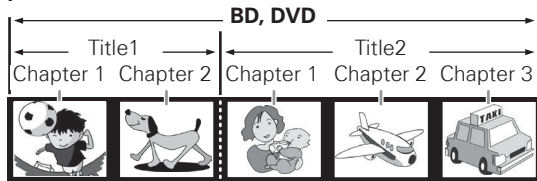

Super Audio CD [Type of Super Audio CD]

• Single layer disc

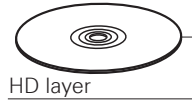

Single layer Super Audio CD with only an HD layer *.

• Dual layer disc

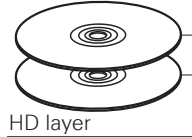

Super Audio CD with a double HD layer *, offering extended playing time and high sound quality.

• Hybrid disc

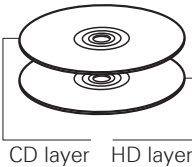

Two-layer Super Audio CD with an HD layer * and a CD layer. The signals on the CD layer can be played on a regular CD player.

* : All Super Audio CDs contain an HD (High Density) layer with high density Super Audio CD signals. This layer can contain a stereo channel area, a multi-channel area, or both a stereo channel and multi-channel area.

DVD-Audio

DVD-Audio discs are divided into several large sections (groups) and small sections (tracks). These sections are all allotted numbers, called group numbers and track numbers.

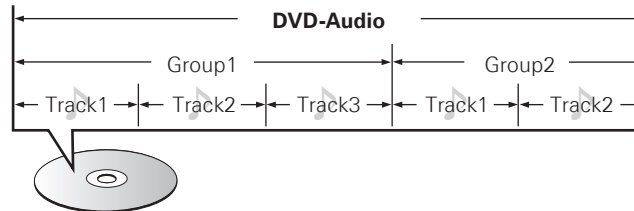

CD

CDs are divided into several sections (tracks). These sections are all allotted numbers called track numbers.



File

MP3/WMA/AAC/LPCM/JPEG/DivX® files recorded on DVD-R/-RW/+R/+RW, CD-R/-RW and SD Memory Card are divided into large segments (folders) and small segments (files). Files are stored in folders, and folders can be placed for storage in a hierarchy. The DBP-A100 can recognize up to 8 levels of folders.

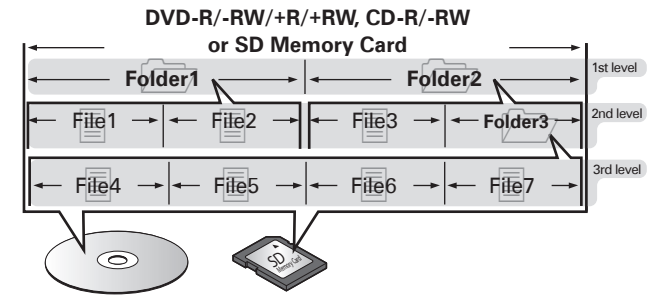

When writing MP3/WMA/AAC/JPEG/DivX® files on a CD-R/-RW disc, set the writing software's format to "ISO9660". The files may not play properly if they are recorded in other formats. For details, refer to the instructions of your writing software.

Cautions on Using Media

Inserting a Disc

- Set the disc in the tray label side up.
- Make sure the disc tray is fully open when inserting the disc.
- Place the disc horizontally in the tray, aligned with the tray guide.



If a disc that cannot be played is loaded or the disc is loaded up-sidedown, "NO DISC" is displayed on the player's display.

NOTE

- Only load one disc at a time. Loading two or more discs can damage the unit or scratch the discs.
- Do not use cracked or warped discs or discs that have been repaired with adhesive, etc.
- Do not use discs on which the sticky part of cellophane tape or labels is exposed or on which there are traces of where labels have been removed. Such discs can get caught inside the player and damage it.
- Do not use discs in special shapes, as they may damage the player.



- Do not push the disc tray in by hand when the power is off. Doing so could damage the set.

Inserting an SD Memory Card

- Insert an SD Memory Card in the direction of the arrow into the SD CARD slot with the label facing up.
- Insert the card straight into the SD CARD slot until it clicks.
- To remove the card, push it in and then release to eject.

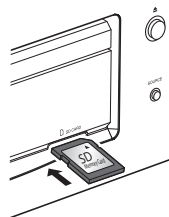

How to Handle Media

- Do not get fingerprints, oil or dirt on discs.
- Take special care not to scratch discs when removing them from their cases.
- Do not bend or heat discs.
- Do not enlarge the hole in the center.
- Do not write on the labeled (printed) surface with ball-point pens, pencils, etc., or stick new labels on discs.
- Condensation may form on discs if they are moved suddenly from a cold place (outdoors for example) to a warm place, but do not try to dry discs with a hairdryer, etc.
- Do not eject a SD Memory Card or turn off the DBP-A100 while a card is being played. This may result in malfunction or loss of the card's data.
- Do not attempt to open or modify SD Memory Cards.
- SD Memory Cards and files can be damaged by static electricity. Do not touch the metal contacts of an SD Memory Card with your fingers.
- Do not use warped SD Memory Cards.
- After use, be sure to remove any disc or SD Memory Card, and store it in its proper card case, to avoid dust, scratches and deformation.
- Do not store discs in the following places:
 - 1.Places exposed to direct sunlight for long periods of time
 - 2.Dusty or humid places
 - 3.Places exposed to heat from heaters, etc.

Cleaning Discs

- If there are fingerprints or dirt on a disc, wipe them off before using the disc.
- Use a commercially available disc cleaning set or a soft cloth to clean discs.

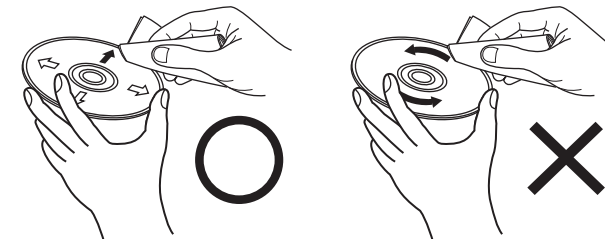

Gently wipe the disc from the inside towards the outside.

Do not wipe with a circular motion.

NOTE

Do not use record spray, antistatic agents, benzene, thinner or other solvents.

About Copyrights

- Unauthorised copying, broadcasting, public performance and lending of discs are prohibited.
- This product incorporates copyright protection technology that is protected by U.S. patents and other intellectual property rights.
- This item incorporates copy protection technology that is protected by U.S. patents and other intellectual property rights of Rovi Corporation. Reverse engineering and disassembly are prohibited.
- Portions of this product are protected under copyright law and provided under license by ARIS/SOLANA/4C.

About the Remote Control

Inserting the Batteries

- ① Remove the rear cover.
- ② Set three R6/AA batteries in the battery compartment in the indicated direction.

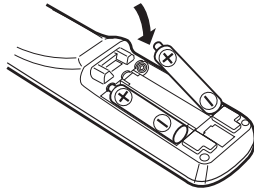
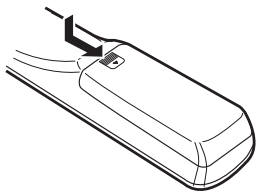

- ③ Put the rear cover back on.

NOTE

- Use R6/AA batteries in this remote control.
- Replace the batteries with new ones if the set does not operate even when the remote control is operated close to the unit. (The supplied batteries are only for verifying operation.)
- Be sure to insert the batteries in the proper direction, following the “⊕” and “⊖” marks in the battery compartment.
- To prevent damage or leakage of battery fluid:
 - Do not use a new battery with an old one.
 - Do not use two different types of batteries.
 - Do not attempt to charge dry batteries.
 - Do not short-circuit, disassemble, heat or dispose of batteries in a fire.
- If the battery fluid leaks, carefully wipe the fluid off the inside of the battery compartment and insert new batteries.
- Remove the batteries from the remote control if it will not be used for a long time.
- Used batteries should be disposed of in accordance with local regulations on battery disposal.

Operating Range of the Remote Control

Operate the remote control while pointing it at the remote sensor.

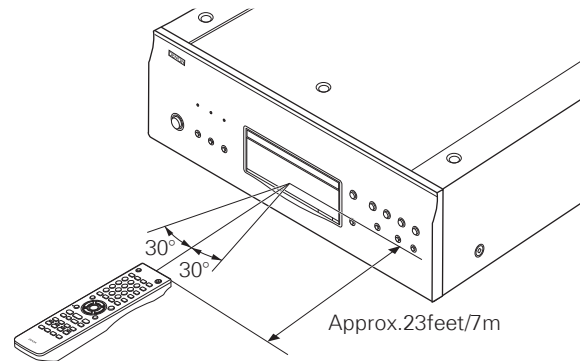

NOTE

The set may function improperly or the remote control may not operate if the remote control sensor is exposed to direct sunlight, strong artificial light from an inverter type fluorescent lamp or infrared light.

Remote Control Settings (Remote Control Side)

Switches when the DBP-A100's remote control operates another DENON BD players in the vicinity.

Set the remote control code simultaneously on the main unit, too. For instructions on setting codes, see GUI menu: “Other Setup” – “Remote Control Setting” – “Remote ID” (☞ page 31).

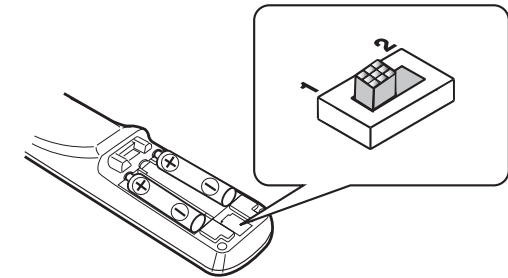

[Remote control code setting]

1 : Set the remote control code to “1”.

2 : Set the remote control code to “2”.



- If the signal code of the remote control does not match the signal code of the unit, the remote control code set on the unit is shown on the display.

[Example]

If the code setting on the unit is “DENON 1”, and the setting on the remote control is “2”, “PLAYER 1” is shown on the display.

NOTE

- Match the signal code of the remote control with the signal code of the unit. If the remote control code is different, you cannot operate the DBP-A100 with the remote control.
- Even if you change the remote control code, set the GUI menu “Other Setup” – “Remote Control setting” – “Receive Legacy Remocon” (☞ page 31) to “Off” when operating the DBP-A100 with a remote control other than DENON's.

Part Names and Functions

Front Panel

For buttons not explained here, see the page indicated in parentheses ().

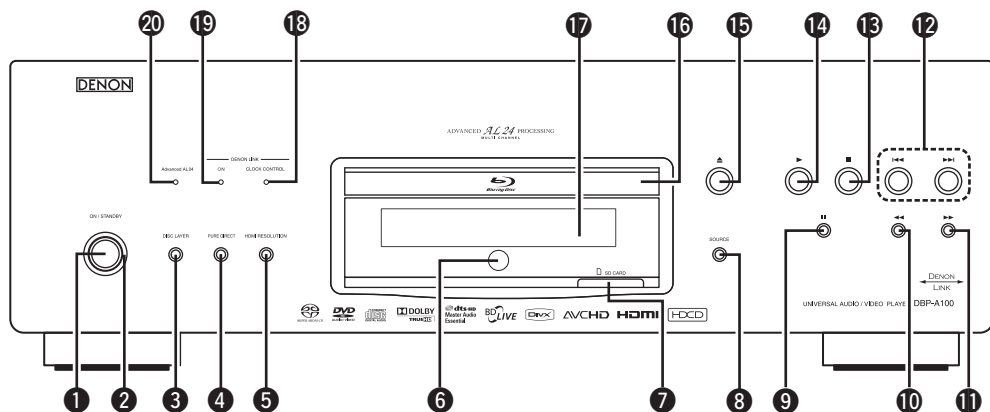

- 1 Power operation button (ON/STANDBY)**..... (20)
- 2 Power indicator**..... (20)
- 3 DISC LAYER button**..... (37)
- 4 PURE DIRECT button**..... (38)
- 5 HDMI RESOLUTION button**..... (13)
- 6 Remote control sensor**..... (7)
- 7 SD CARD slot**..... (6)
- 8 SOURCE button**..... (34)
- 9 Pause/Still button (II)**..... (41, 43)
- 10 Fast reverse/slow button (◀◀)**..... (43)
- 11 Fast forward/slow button (▶▶)**..... (43)
- 12 Reverse-skip/Forward-skip buttons (◀◀, ▶▶)**..... (41)
- 13 Stop button (■)**..... (41)
- 14 Play button (▶)**..... (37)
- 15 Disc tray open/close button (⏏)**..... (34)
- 16 Disc tray**..... (6)
- 17 Display**..... (8)
- 18 CLOCK CONTROL indicator**..... (17, 28)
- 19 DENON LINK indicator**..... (50)
- 20 ADVANCED AL24 indicator**..... (50)



When power is in standby mode, press **14** and **15** to turn the power on.

Display

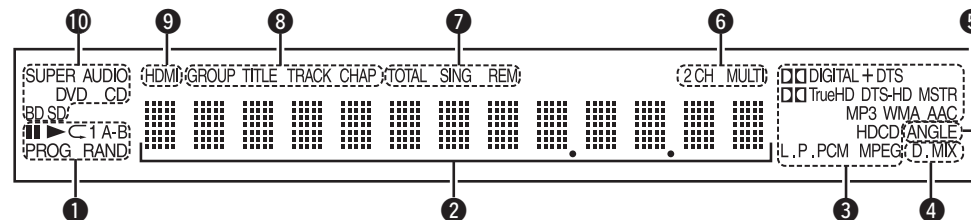

- 1 Playback mode indicators**
 - ▶ : During Playback
 - II : During pause and step-by-step playback
 - PROG : During program playback
 - RAND : During random playback
 - C 1 A-B : During repeat playback
- 2 Information display**
Displays various information or playback elapsed time and so on of the disc.
- 3 Playback format indicators**
- 4 Downmix indicator**
Displayed when playing back downmix permitted audio.
- 5 Angle information indicator**
Displayed when a scene on the currently playing disc has been shot at various angles.
- 6 Audio channel indicators**
Displays the number of audio signal channels during playback.
2CH : 2-channel playback
MULTI : Multi-channel playback
- 7 Time mode indicators**
TOTAL : Total time of Super Audio CD and CD
SING : Elapsed time of title/chapter/track/file being played
REM : Remaining time of title/chapter/track/file being played
- 8 Group/Title/Track/Chapter indicators**
- 9 HDMI output indicator**
Display when HDMI video or audio signals are being output.
 Does not display when the HDMI cable is not correctly connected or when the HDMI connection is not verified.
- 10 Media indicators**
BD : BD
DVD : DVD-Video, DVD-R/+R/-RW/+RW
DVD AUDIO : DVD-Audio
SUPER AUDIO CD : Super Audio CD
CD : CD
SD : SD Memory Card
Displays the inserted media.

Rear Panel

For buttons not explained here, see the page indicated in parentheses ().

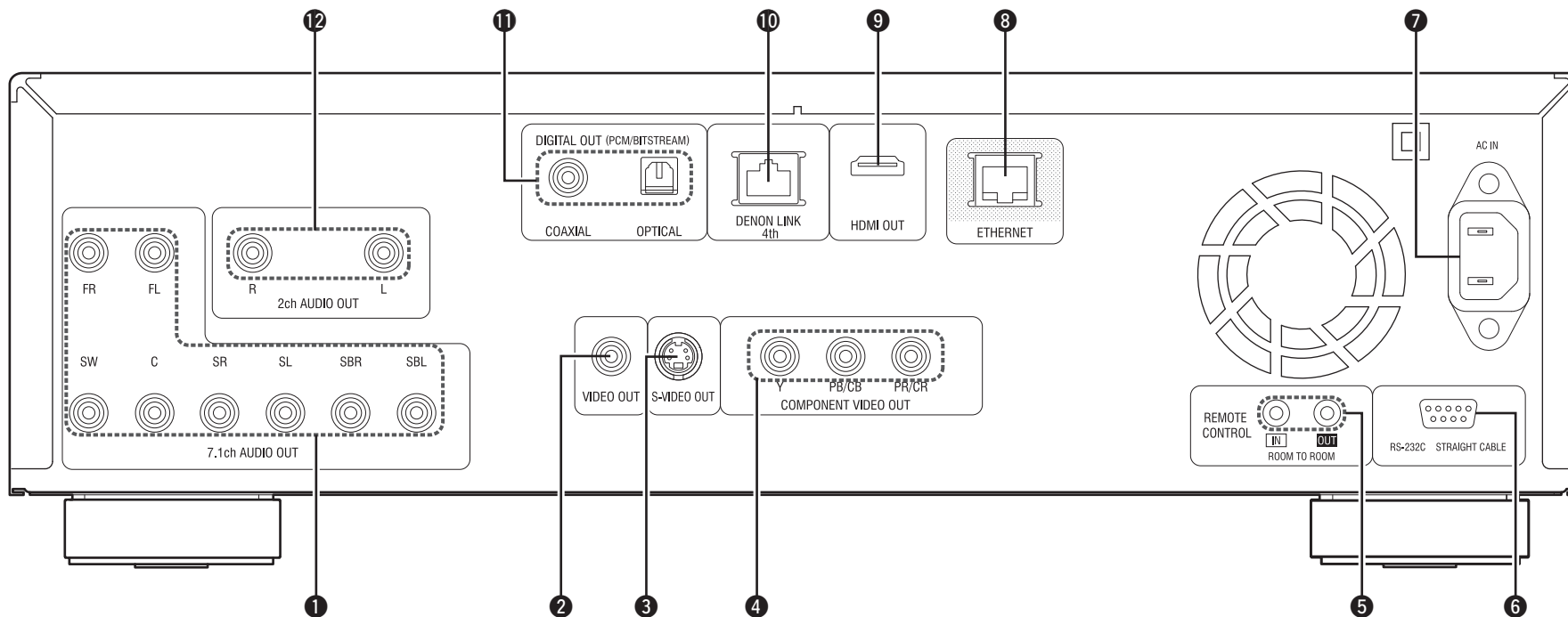

- 1** 7.1ch AUDIO OUT connectors (16)
- 2** VIDEO OUT connector (18)
- 3** S-VIDEO OUT connector (18)
- 4** COMPONENT VIDEO OUT connectors (18)
- 5** ROOM TO ROOM IN/OUT jacks
Extension jack for future use.
- 6** RS-232C connector
Extension connector for future use.
- 7** AC inlet (AC IN) (20)
- 8** ETHERNET connector (19, 20)
- 9** HDMI OUT connectors (13)
- 10** DENON LINK 4th connector (17)
- 11** DIGITAL OUT OPTICAL/COAXIAL connectors (15)
- 12** 2ch AUDIO OUT connectors (18)
For software recorded in multi-channel, analog signals that have been down-mixed into 2 channels are output.

NOTE

- Do not touch the inner pins of the connectors on the rear panel. Electrostatic discharge may cause permanent damage to the unit.
 - Do not put your finger or foreign objects in the fan opening. Doing so could cause injury or unit failure.
 - When outputting audio from a DTS-HD 7.1-channel source to HDMI or analog 7.1 channel audio, and to 2-channel analog audio, perform the following settings so that the audio is down mixed to the correct 2-channel analog audio output signal as intended by the producer of the source and DTS, Inc.
 - In "HDMI Setup", set "Audio Setup" to "2Ch" (☞ page 23).
 - In "Audio Setup", set "7.1ch Audio Out" to "2 Channel" (☞ page 25).
- If "Audio Setup" in "HDMI Setup" and "7.1ch Audio Out" in "Audio Setup" are not set to "2Ch" or "2 Channel" respectively, 2-channel analog audio is output using this unit's own downmix. In this case, the downmix may differ from that intended by the producer of the source and DTS, Inc.

Remote Control

For buttons not explained here, see the page indicated in parentheses ().

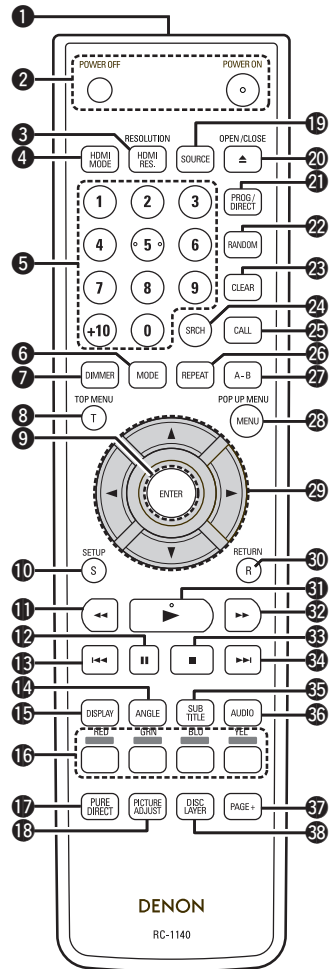

1 Remote control signal transmitter	(7)	26 REPEAT button	(44)
2 POWER buttons (POWER OFF, POWER ON)	(20)	27 A-B button	(44)
3 HDMI RESOLUTION button (HDMI RES.)	(13)	28 MENU/POP UP MENU button	(36)
4 HDMI MODE button	(14)	29 Cursor buttons (Δ ▽ ◀ ▶)	(22)
5 Number buttons (0 ~ 9, +10)	(35, 36)	30 RETURN button (R)	(22)
6 MODE button	(32)	31 Play button (▶)	(37)
7 DIMMER button	(47)	32 Fast-forwarding button (▶▶)	(43)
8 TOP MENU button (T)	(36)	33 Stop button (■)	(41)
9 ENTER button	(22)	34 Forward-skip button (▶▶)	(41)
10 SETUP button (S)	(21)	35 SUBTITLE button	(46)
11 Fast-reversing button (◀◀)	(43)	36 AUDIO button	(45, 46)
12 Pause/Still button ()	(41, 43)	37 PAGE + button	(38)
13 Reverse-skip button (◀◀)	(41)	38 DISC LAYER button	(37)
14 ANGLE button	(47)		
15 DISPLAY button	(34)		
16 RED/GRN/BLU/YEL buttons			
17 PURE DIRECT button	(38)		
18 PICTURE ADJUST button	(33)		
19 SOURCE button	(34)		
20 Disc tray OPEN/CLOSE button (⬆)	(34)		
21 PROGRAM/DIRECT button (PROG/DIRECT)	(45)		
22 RANDOM button	(44)		
23 CLEAR button	(33)		
24 SEARCH button (SRCH)	(37)		
25 CALL button	(45)		



- When power is in standby, press 20 and 31 to turn the power on.
- You can use 16 when operating the BD popup menu screen, etc.

Connections

Connect the DBP-A100 as follows before using. Make connections according to the equipment you are connecting. Some DBP-A100 settings may be necessary depending on the connection method. Check each connection item for more information.

1 Home Theater Playback – Playing on a Multi-Channel System – page 13

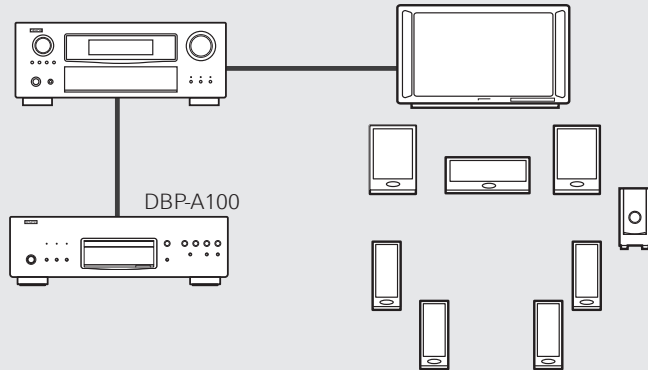





Multi-channel Audio + Video

- **HDMI connection**
"Using an HDMI Cable to Connect to an AV Amp or Television" ( page 13)

..... Or

Multi-channel Audio

- **DENON LINK connection**
"Making a Jitter-free Connection" ( page 17)
"Making a Normal Connection" ( page 17)
- **Digital audio connection**
"Connection to an AV Amp with No HDMI Audio Input" ( page 15)
- **Analog 7.1ch connection**
"Connecting to a Device with an Analog Multi-channel Audio Input Terminal" ( page 16)

Video

- **Analog video connection**
"Connection to an AV Amp with No HDMI Video Input" ( page 17)

2 Playing with a Direct Connection to a TV page 18

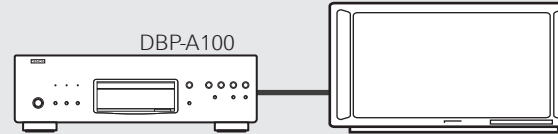

Audio + Video

- **HDMI connection** ( page 13)

..... Or

Audio

- **Analog audio connection** ( page 18)

Video

- **Analog video connection** ( page 18)

4 Recording a CD page 19

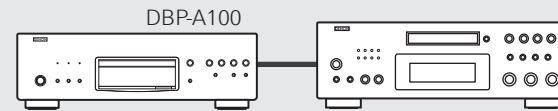



Digital output

- **Digital output**
"Connecting to a Digital Recording Device" ( page 15)

- **Connecting the Power Cord**  page 20
- **Once Connections are Completed**

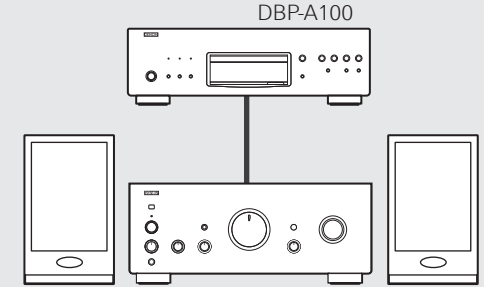
3 Playing 2-Channel Audio page 18



- **2-ch stereo pin plug cable (unbalanced) connection**
"Connecting to a Device with Analog 2-channel Audio Input Terminal with Stereo Pin Plug Cable" ( page 18)

5 Using the BD-LIVE function or updating the software version of DBP-A100 page 19

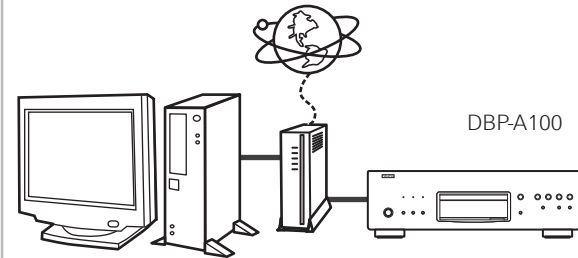





- **LAN connection**
"Connecting to a Network" ( page 19)







Preparation

Connecting Cables

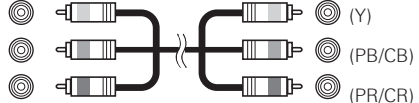
Prepare cables corresponding to the devices you choose.

Audio and video cables	
HDMI connections (Sold separately)	 19-pin HDMI cable
Audio cables	
Coaxial digital connections (Sold separately)	 Coaxial digital (75 Ω pin-plug) cable
Optical digital connections (Sold separately)	 Optical cable
Analog connections (stereo, surround) (1 included)	 Stereo pin plug cable
Analog connections (center, subwoofer) (Sold separately)	 Pin-plug cable

Video cables	
Component video connections (Sold separately)	 Component video (75 Ω) cable (Y) (PB/CB) (PR/CR)
S-Video connections (Sold separately)	 S-Video cable
Video connections (Included)	 75 Ω pin-plug video cable
Other cables	
DENON LINK connections (Included)	 DENON LINK cable
Network connections (Sold separately)	 Ethernet cable

NOTE

- Do not plug the power cord into the power outlet until all connections are complete.
- Be sure to read the owner's manuals for connected devices.
- First check the connection channels and then correctly connect the input and output channels.
- Do not bundle the power cord with connection cables. This can result in noise.



- Use only HDMI (High Definition Multimedia Interface) cables that bear the HDMI logo (genuine HDMI product). Using cables without the HDMI logo (non-genuine HDMI product) may result in abnormal playback.
- When outputting deep colour or 1080p, etc., we recommend you use a High Speed HDMI cable for enhanced, high-quality playback.

1. Home Theater Playback – Playing on a Multi-channel System –

NOTE

- When the HDMI video resolution is set to “1080P24”, a HDMI video signal is output from the DBP-A100 with a resolution of 1080P and a frame rate of 24 frames per second, regardless of the video signal on the disc being played. Because of this, when playing discs containing video signals recorded with a frame rate of something other than 24 frames per second, the movement of the picture may be unnatural. If this happens, set the HDMI video resolution to something other than “1080P24”.
- When the “I/P Direct” (page 23) setting is “On” and a disc with a frame rate of 24 frames per second is played, no video signals are output from the video or S-Video outputs.
- When the “I/P Direct” (page 23) setting is “Off”, “1080P24” is not displayed.

Setting HDMI Audio Output

- When you press  and set “HDMI Setup” – “Audio Setup” to “Auto” (page 23) on the GUI menu, the audio mode is set according to the connected device.
- When you want to set the HDMI audio output to one of your choosing change it according to the following table.
- Refer to the owner’s manual of the connected device for HDMI audio input specifications compatible with the connected device.

Device to be connected	Setting items	About output signal and speaker settings
Devices with the following built-in decoders • Dolby TrueHD • Dolby Digital Plus • Dolby Digital • DTS-HD • DTS	Auto	DBP-A100 outputs a bitstream signal that is decoded by the connected device. ※ In this case, you cannot make a speaker setting for HDMI audio with the DBP-A100. Make the setting with the connected device. ※ When outputting Dolby TrueHD or DTS-HD audio, press  and set “BD Audio Mode” to “HD Audio Output” (page 32).
Devices compatible with multi-channel HDMI audio input, but not capable of speaker settings for each channel	Multi LPCM BM On	Outputs multi-channel Linear PCM audio signals with speaker settings by the DBP-A100. ※ For speaker settings, on the GUI menu, “Audio Setup” – “7.1ch Audio Out” – “Multi Channel” – “Speaker Configuration” (page 25). ※ BM : Bass Management (means multi-channel speaker setting)
Devices compatible with multi-channel HDMI audio input, and capable of speaker settings for each channel	Multi LPCM BM Off	Output of multi-channel Linear PCM audio signals from the DBP-A100. Make speaker settings with the connected device. ※ BM : Bass Management (means multi-channel speaker setting)
Devices compatible with 2-channel HDMI audio input	2Ch	Downmixed 2-channel Linear PCM audio signals are output from the DBP-A100. Make speaker settings with the connected device.
Devices not compatible with HDMI audio signal input	Mute	Audio signal are not output from the DBP-A100’s HDMI terminal. Only video signals are output from the HDMI terminal. ※ Make the audio connections.

Audio signal from the HDMI output terminal

You can change the audio format and playback the number of channels according to the specifications of the device to which the DBP-A100’s HDMI audio output signals are input. Make settings while checking the specifications of the audio device to be connected as well as the audio format/number of channels stored in media and files for playback.

Media/Files	Audio format	Setting “HDMI Setup” – “Audio Setup” (page 23) on the GUI menu		
		Auto	Multi LPCM BM On/Off	2Ch
BD	Dolby Digital	Dolby Digital * 1	Multi LPCM	2-ch Downmix LPCM
	Dolby Digital Plus	Dolby Digital Plus * 1		
	Dolby TrueHD	Dolby TrueHD * 1		
	DTS	DTS * 1		
	DTS-HD	DTS-HD * 1		
	LPCM	Multi LPCM		
AVCHD	Dolby Digital	Dolby Digital	Multi LPCM	2-ch Downmix LPCM
	LPCM	Multi LPCM		
DVD-Video	Dolby Digital	Dolby Digital	Multi LPCM	2-ch Downmix LPCM
	DTS	DTS		
	LPCM, MPEG	2-ch LPCM		
DVD-Audio	LPCM, PPCM	Multi LPCM		2-ch Downmix LPCM
Super audio CD * 2	Multi area	Multi LPCM		
	Stereo area	2-ch LPCM		
	CD layer	2-ch LPCM		
DivX®	Dolby Digital	Dolby Digital	Multi LPCM	2-ch Downmix LPCM
	MP3, MP2	2-ch LPCM		
CD, MP3, WMA, AAC, LPCM		2-ch LPCM		
DTS-CD		DTS	Multi LPCM	2-ch Downmix LPCM

* 1 : Multi LPCM signals are output when “BD Audio Mode” is set to “Mix Audio Output” (page 32). Multi LPCM signals are output when outputting HDMI video signals with resolutions of 480i/576i or 480p/576p.

* 2 : Super Audio CD audio signals are output at 44.1 kHz 16-bit.



Even if “HDMI Setup” – “Audio Setup” on the GUI menu is set to “Auto” (page 23), multilinear PCM or downmixed 2-channel linear PCM signals are output if a device that does not support bitstream is connected.

Copyright protection system

In order to play back digital video and audio such as BD-Video or DVD-Video via HDMI connection, both the player and TV or the AV Amp need to support the copyright protection system known as HDCP (High-bandwidth Digital Content Protection System). HDCP is copyright protection technology comprising data encryption and authentication of the connected AV device. Our DBP-A100 supports HDCP.

NOTE

- If a device that does not support HDCP is connected, video and audio are not output correctly. Read the owner's manual of your television or AV Amp for more information.
 - The audio signal from the HDMI output terminal (sampling frequency, number of channels, etc.) may be limited by the HDMI audio specifications of the connected device for permissible inputs. For example, if the HDMI audio specification of the connected device is 5.1 channels, 5.1-channel audio will be automatically output even when playing back 7.1 channels on the DBP-A100. In this case, analog audio output will also be 5.1-channel.
 - Audio signal input may not be supported depending on the HDMI compatible monitor (projector, etc.) being used.
- When the DBP-A100 is connected to this kind of device, audio signals are not output from the HDMI terminal.

Connecting to an AV Amp with No HDMI Audio Input

When playing back Dolby Digital Plus/Dolby TrueHD/DTS-HD audio recorded on a BD disc, the DBP-A100 outputs Dolby Digital or DTS bitstream from its digital audio output terminal.

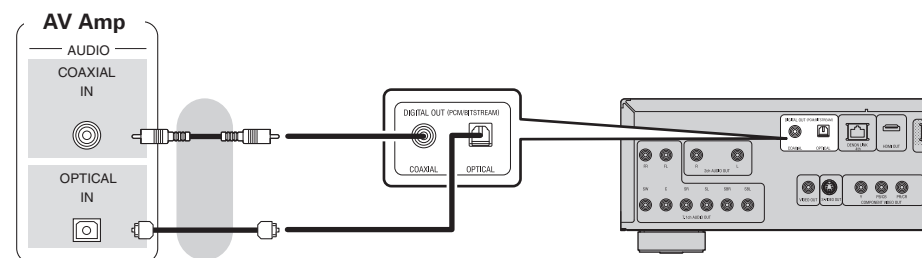
**NOTE**

- Dolby TrueHD/Dolby Digital Plus/DTS-HD audio signals are not output with this connection. When outputting Dolby TrueHD/Dolby Digital Plus/DTS-HD audio signals, do so with an HDMI connection (see page 13, "Using an HDMI Cable to Connect to an AV Amp or Television").
- Super Audio CD's DSD signal cannot be output. Also, during CD layer playback, 44.1 kHz/16-bit Linear PCM is output.
- Do not output DTS audio signals to an AV Amp that does not support DTS. Playing back a BD/DVD disc with recorded DTS content can generate noise and even damage your speakers.
- When connecting with an optical transmission cable (sold separately), make sure the plug shape aligns with the socket, and insert fully.

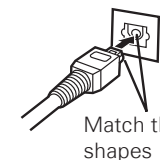

1. Home Theater Playback – Playing Back Using Multi-channel System –

Audio Signal from the Digital Audio Output (Optical/Coaxial) Terminal

The DBP-A100 can convert and output digital audio signal format recorded on various media. Convert the digital audio signal in accordance with the specifications of the device that is to input digital audio output signals from the DBP-A100.

Media/Files	Audio format	Setting "Audio Setup" – "Digital Out" (page 27) on the GUI menu	
		Bitstream	PCM/ PCM Down Sampling
BD	Dolby Digital	Dolby Digital * 1	2-ch Downmix LPCM
	Dolby Digital Plus		
	Dolby TrueHD		
	DTS	DTS * 1	
	DTS-HD		
	LPCM	2-ch Downmix LPCM * 1	
AVCHD	Dolby Digital	Dolby Digital	2-ch Downmix LPCM
	LPCM	2-ch Downmix LPCM	
DVD-Video	Dolby Digital	Dolby Digital	2-ch Downmix LPCM
	LPCM, MPEG	DTS	
DVD-Audio	LPCM, PPCM	2-ch Downmix LPCM	
Super Audio CD	Multi area	Audio is not output	
	Stereo area		
	CD layer	2-ch LPCM	
DivX®	Dolby Digital	Dolby Digital	2-ch Downmix LPCM
	MP3, MP2		
CD		2-ch LPCM	
MP3, WMA, AAC, LPCM			
DTS-CD		DTS	2-ch Downmix LPCM (DTS * 2)

* 1 : Bitstream signals are output according to the BD re-encode setting when "BD Audio Mode" is set to "Mix Audio Output" (page 32).

* 2 : When "HDMI Setup" – "Audio Setup" is set to "Auto" on the GUI menu and bitstream is output from the HDMI, the DTS bitstream is output from the digital audio output (optical/coaxial) as well.



For content with copyright protection, audio signal is down-sampled to 48kHz 16bit and output.

Connecting to a Device with an Analog Multi-channel Audio Input Terminal

Outputs multi-channel audio decoded by the DBP-A100.

If your audio system has an analog multi-channel audio input terminal, connect using audio cable (sold separately).



In the case of a 5.1-channel connection, you do not need to connect the SBR/SBL terminals. In this case, on the GUI menu, select "Audio Setup" – "7.1ch Audio Out" – "Multi Channel" – "Speaker Configuration" – "Surr. Back", and set "Size" to "None" (page 25).

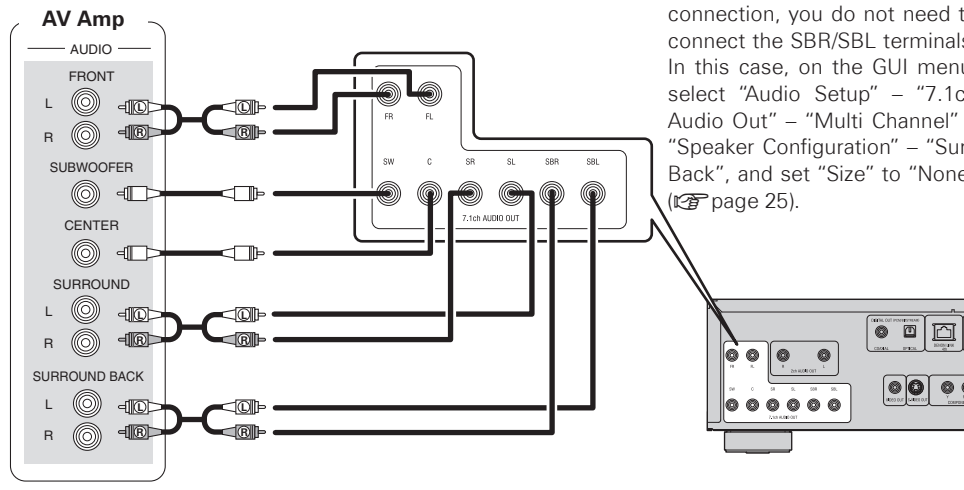

DENON LINK Connection ① Making a Jitter-free Connection

BD

When you connect the DBP-A100 to a DENON LINK 4th compatible AV Amp using a DENON LINK cable and HDMI cable, during BD playback the DBP-A100's circuit operates with the AV Amp's master clock signal. (The clock control indicator of the DBP-A100 lights.) This enables transmission of high-quality digital audio with minimal jitter.

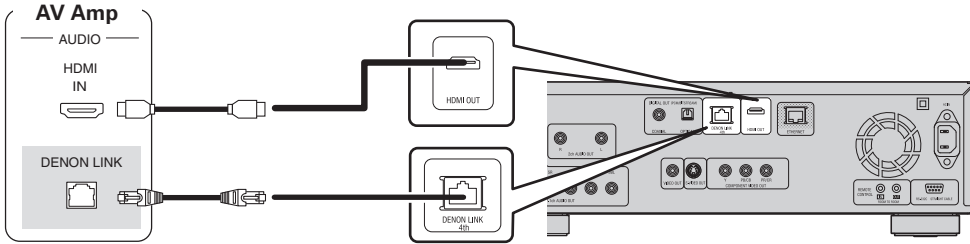

NOTE

- When using DENON LINK 4th functions, press the **HDMI MODE** and set to "HDMI On".
- The jitter-free function does not work except during BD playback. In this case, the video signal is output from the HDMI OUT terminal, and the audio signal from the DENON LINK terminal.

DENON LINK Connection ② Making a Normal Connection

- When connecting to a DENON LINK-compatible AV Amp, the multi-channel signals of DVD-Audio discs, Super Audio CDs, etc., can be transferred as such in digital format.
 - The DENON LINK connection requires the version of AV Amp to be connected to match the DBP-A100 version. Check the version of the AV Amp, and then on the GUI Menu, set "DENON LINK Setup" – "DENON LINK Mode" (page 28).
- If the DBP-A100 and AV Amp versions do not match, audio cannot be output correctly.

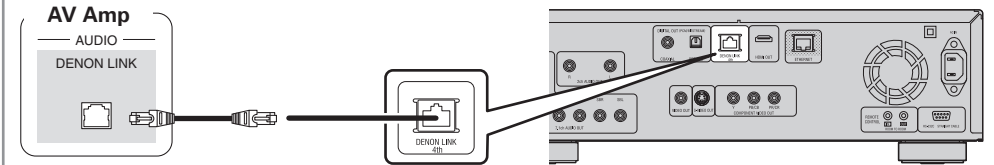

NOTE

DENON LINK does not support BD audio transmission.



- DENON LINK supports digital transmission up to 24 bit/2-ch at 192/176.4 kHz, and up to 24 bit/6-ch at 96 kHz or less.
- When you have made a DENON LINK connection, the DBP-A100's speaker setting becomes invalid. (Make the speaker setting on the connected AV Amp)
- DENON LINK 2nd cannot transmit multi/stereo area audio of a Super Audio CD.

Connecting to an AV Amp with No HDMI Video Input

- Check the video terminals and connect to one of them.
- When connecting using the component video outputs, press **HDMI MODE** and set it to "HDMI Off".

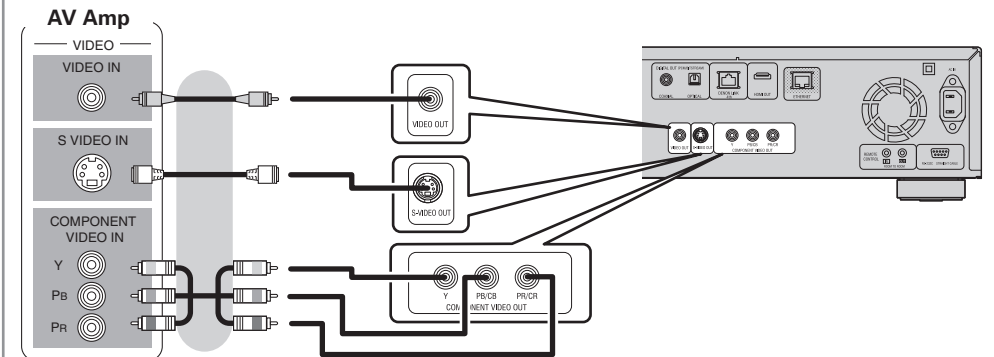

2. Playing with a Direct Connection to a TV

Check the television's audio and video terminals and connect to one of them.

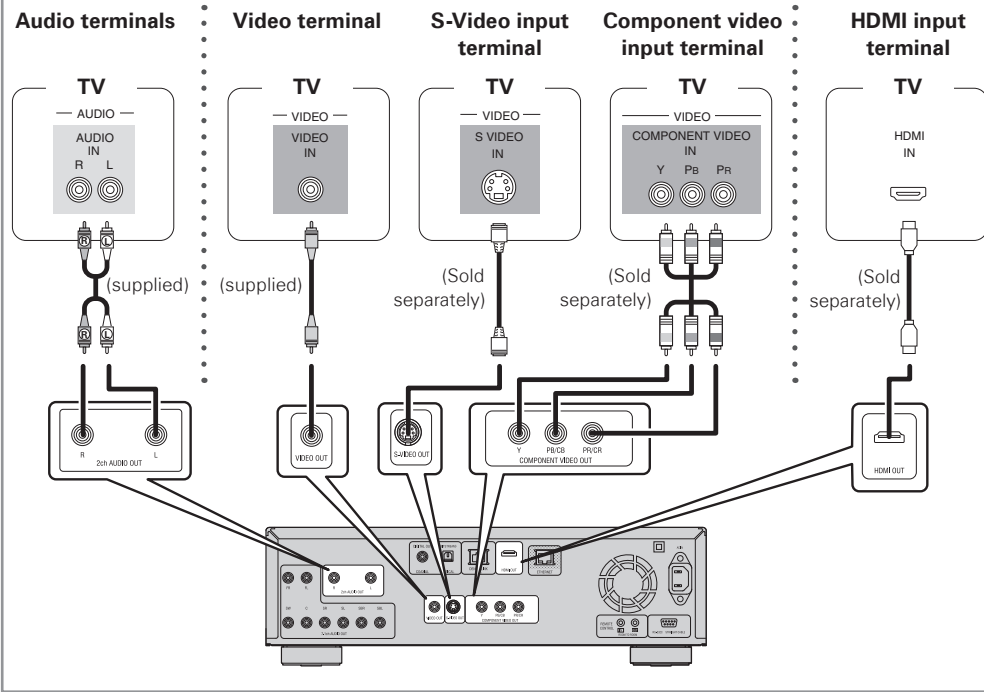

NOTE

Do not connect the DBP-A100's video output via a VCR (Video Cassette Recorder). Some media contain copy prohibiting signals, which will disturb the screen image.
When playing an NTSC disc, the DBP-A100's video output changes to the NTSC signal format.
When playing a PAL disc, the DBP-A100's video output changes to the PAL signal format.

When connected to the television's component video input terminal

- The DBP-A100's component video output supports 480i/576i/480p/576p/720p/1080i output. Match the output to the corresponding resolution of the connected television by setting on the GUI menu: "Video Setup" – "Component Resolution" (page 24). Images will not be projected normally if the television resolution and DBP-A100's output resolution do not match. Copyright protected DVDs are output in 480i/576i or 480p/576p.

NOTE

When you press and set it to "HDMI On", no video signals are output from the component video terminals. When using the component video terminals, set the HDMI mode to "HDMI Off".

When connected to the HDMI input terminal

It outputs both digital video and digital audio signals.
See "Required Settings for HDMI Connection" (page 13) for HDMI video output and audio output settings.

3. Playing Back 2-Channel Audio

Connecting to a Device with Analog 2-channel Audio Input Terminals with a Stereo Pin Plug Cable

When connecting using the analog 2-channel audio output terminals

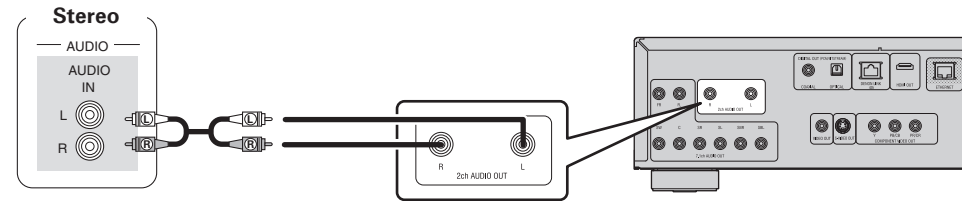

For software recorded in multi-channel, an analog signal down-mixed to 2 channels is output.

When connecting using the analog 7.1-channel audio output terminals

On the GUI menu, select "Audio Setup" – "7.1ch Audio Out", and set it to "2 channel" (page 25).

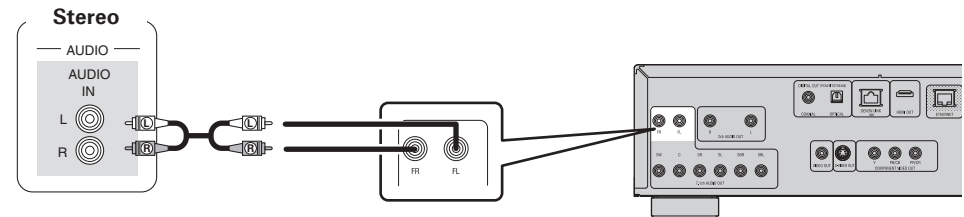

For software recorded in multi-channel, an analog signal down-mixed to 2 channels is output.

4. Recording a CD

Connecting to a Digital Recording Device

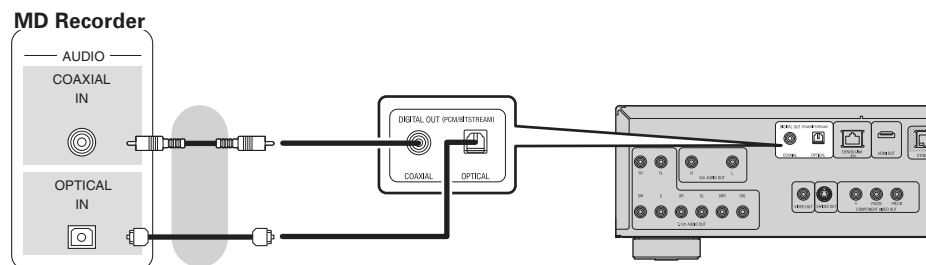

When converting multi-channel audio to 2-channel for output, select "Audio Setup" – "Digital Out" on the GUI menu and set it to "PCM Down Sampling" (page 27). If you play back DVD or other media with an incorrect configuration, a deafening noise occurs that may damage your speakers.

5. Using BD-LIVE function or updating the software version of DBP-A100

Connecting to a Network

- You can use a disc that offers the BD-LIVE function by connecting the unit to the Internet (page 36).
- You can update by downloading the latest firmware from the Internet. For more information, on the GUI menu select "Other Setup" – "Firmware Update" (page 31).
- You can also operate this unit from a computer using the Web control function (page 47).

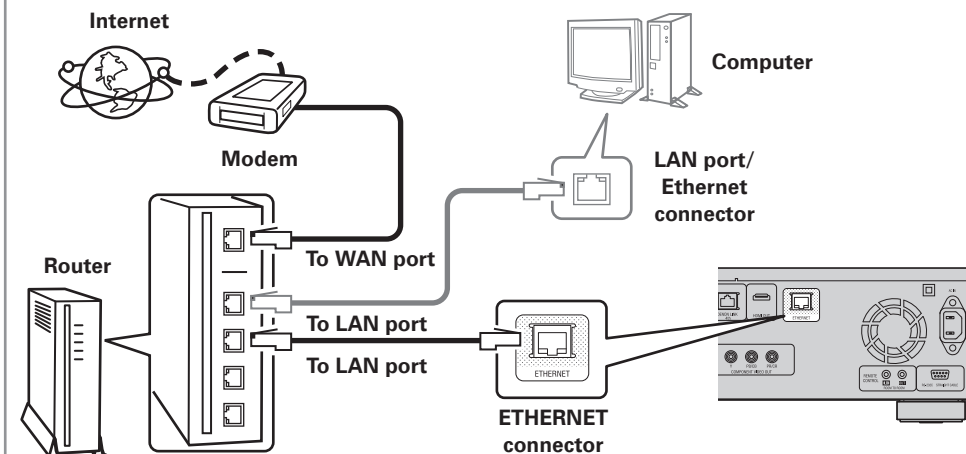

- See "Network Setup" (page 29) on the GUI menu for more information on network settings.

5. Using BD-LIVE function or updating the software version of DBP-A100

System Requirements

Internet Connection via Broadband

Modem

A device that connects to the broadband and conducts communications on the Internet. Some modems also incorporate a router.

Router

When using the DBP-A100, we recommend a router with the following features.

- Built-in DHCP (Dynamic Host Configuration Protocol) server. This function automatically assigns an IP address on the LAN.
- Built-in 100BASE-TX switch (built-in switching hub compatible with speeds upwards of 100 Mbps)

Ethernet cable (CAT-5 or greater recommended)

- An ethernet cable is not included with the DBP-A100.
- Use only shielded STP or ScTP LAN cable which is available at retailer.
- We recommend a shielded straight cable (normal type) for Ethernet connections.

If you use the flat type or a non-shielded cable, the noise may adversely affect other devices.



For Internet connections, use an ISP (Internet Service Provider). Ask your local dealer for details.

NOTE

- Do not connect an ETHERNET connector directly to the LAN port/Ethernet connector on your computer.
- It is necessary to subscribe to an ISP in order to connect to the Internet. If you already have a broadband connection, there is no need to subscribe anew.
- The router you can use varies with the ISP. For more information, contact your ISP or PC dealer.
- DENON assumes no responsibility whatsoever for any communication errors or problems resulting from customer's network environment or connected devices.

Other

- The DBP-A100 can use the DHCP function to automatically set up the network.
- When setting up your network manually, after subscribing to an ISP, make the settings according to directions in "Network Setup" on the GUI menu (page 29).
- If you connect the DBP-A100 to a network without a DHCP function, conduct IP address and other settings according to "Network Setup" on the GUI menu (page 29).
- The DBP-A100 does not support PPPoE. If you subscribe to a service that is set with PPPoE, a PPPoE-compatible router is required.
- When setting up the network manually, consult with your network administrator for the settings to make.

Connecting the Power Cord

Connect the included power cord to the DBP-A100, and plug it into an AC outlet.

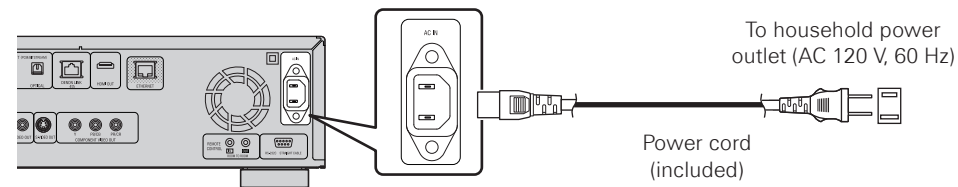

NOTE

- Be sure to insert the power plug firmly. Incomplete connection results in noise.

Once Connections are Complete

Turning the Power On

Press the unit's  or the remote control's .

The power turns on, and the power indicator lights green. "LOADING" appears on the display, and disc information is read.

※ The "NO DISC" message is displayed if a disc is not loaded.

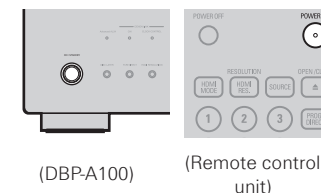

(DBP-A100)



(Remote control unit)



On the GUI menu, when "Other Setup" – "Auto Power Mode" – "On" (page 31), the following states are maintained for about 30 minutes, and then the power is automatically turned to standby.

- Disc not loaded
- Playback has stopped
- Stopped due to resume function

When power is switched to standby

Press either  on the unit, or  on the remote control.

[Power indicator status in standby mode]

- Power Saving Standby : Off
- Normal Standby : Red
- Quick Start Mode : Red

NOTE

During power standby, a slight amount of power is consumed. To totally cut off the power, remove the power cord from the power outlet.

GUI Menu Setup

Menu Map

Pressing  displays the GUI menu. From this menu, you can move to various setting screens.

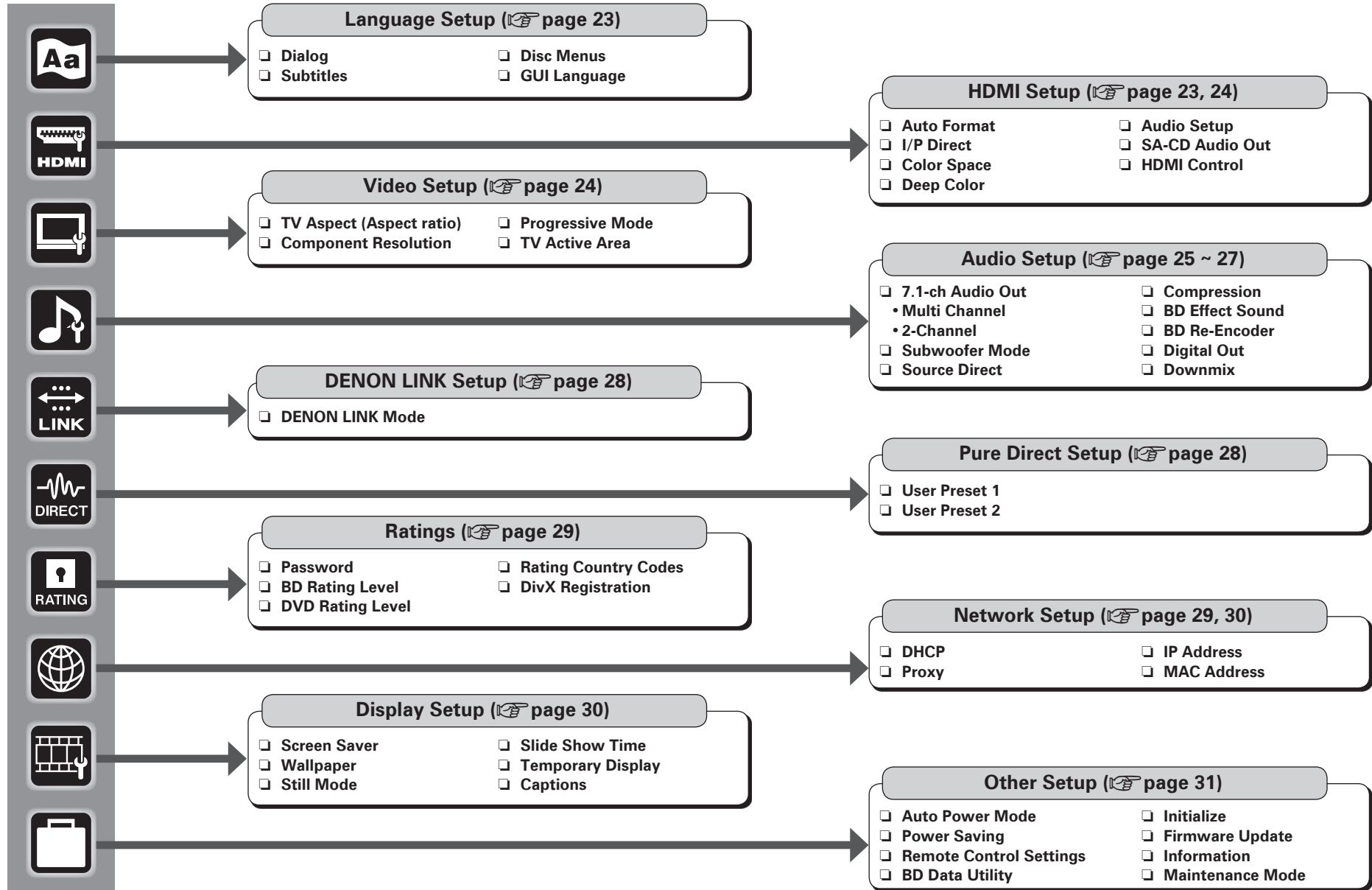

GUI Menu Operation

1 Press .
The GUI menu is displayed on the TV screen.

2 Press to select the menu to be set or operated.

※ To return to the previous item, press or .

3 Press to enter a setting.

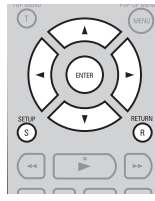

❑ Exiting the GUI Menu

- Press while the GUI menu is displayed.
- The GUI menu display disappears.

NOTE

You must use the GUI menu to make settings or operate while a disc or SD Memory Card is not inserted. In cases in which the resume function is activated, you may not make correct settings.

Examples of GUI Menu Screen Displays

Typical examples are described below.

[Example 1] Menu selection screen (Top menu)

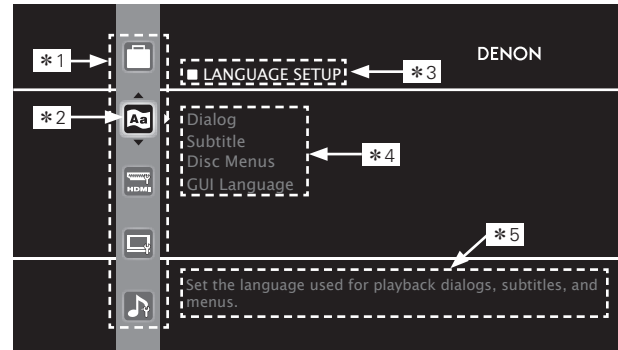

- * 1 : List of GUI menu setup icons
- * 2 : Currently selected setup icon
- * 3 : Currently selected setup item
- * 4 : List of currently selected setup items
- * 5 : Guide text for the currently selected setup item

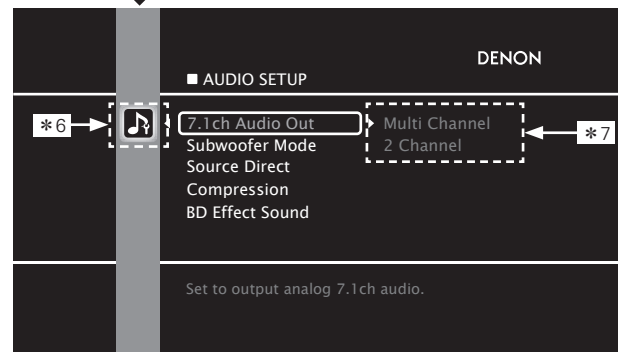
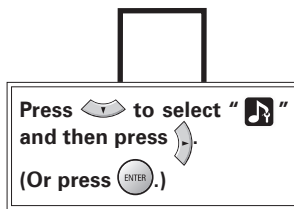

- * 6 : Selected setup icon
- * 7 : Options of the selected setup item

[Example 2] Rating-Country Code input screen (with virtual keyboard)

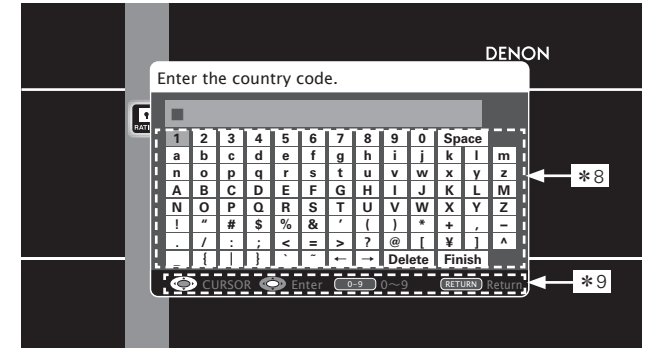

- * 8 : Virtual keyboard
- * 9 : Operation button guide

❑ Icon

Switch the selected item (Use to switch.)



Switch to the next item

Selected item (Use to switch.)

Switch the selected item (Use to switch.)

❑ List

Returns to the previous item (Use or to switch.)

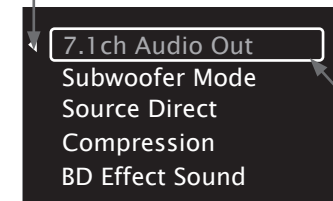

Switch to the next item

(Use to switch.)

Selected item

※ Switch the selected item using .



Text colors of selected items of the GUI menu are as follows:

- White : These items can be selected.
- Gray : These items cannot be selected.



Language Setup

Default settings are underlined.

Sets the language used for playback dialogs, subtitles, and menus.

Setting items	Setting contents
Dialog Sets the dialog used to play BDs or DVDs.	Original : Plays the dialog selected at the top in the language menu stored in the disc. <u>English/French/Spanish/German/Japanese/Italian/Swedish/Dutch/Russian/Chinese/Korean/Danish/Finnish/Norwegian/Icelandic/Hungarian/Romanian/Turkish/Greek/Irish/Portuguese/Polish/Czech/Slovak/Bulgarian</u> Others : Enter the language code.
Subtitle Sets the subtitle language used to play BDs or DVDs.	Off : No subtitles displayed <u>English/French/Spanish/German/Japanese/Italian/Swedish/Dutch/Russian/Chinese/Korean/Danish/Finnish/Norwegian/Icelandic/Hungarian/Romanian/Turkish/Greek/Irish/Portuguese/Polish/Czech/Slovak/Bulgarian</u> Others : Enter the language code.
Disc Menus Sets the language used for BD or DVD menus.	<u>English/French/Spanish/German/Japanese/Italian/Swedish/Dutch/Russian/Chinese/Korean/Danish/Finnish/Norwegian/Icelandic/Hungarian/Romanian/Turkish/Greek/Irish/Portuguese/Polish/Czech/Slovak/Bulgarian</u> Others : Enter the language code.
GUI Language Sets the GUI language.	<u>English/Français/Español/Deutsch/Italiano/Svenska/Nederlands/日本語</u>

NOTE

The setting may not be active depending on the disc.



If "Other" is selected for "Dialog", "Subtitle" or "Disc Menus", refer to the "Language Code List" (page 51), and use the number buttons 0 ~ 9 to input the language code, then press **ENTER** to set.



HDMI Setup

Default settings are underlined>.

Sets the HDMI output signal or HDMI control function.

Setting items	Setting contents
Auto Format Sets the content of HDMI video output resolution item "Auto" (page 14) with .	Max Res. : Outputs data using the maximum resolution that can be handled by the connected TV. Panel Res. : Outputs data using the maximum resolution of the panel of the connected TV. If the TV does not support 1080P24, video is output in 1080P format.
I/P Direct Sets whether the I/P converter converts 24P frames.	Off : Converts 1080 progressive 24 frames to 60 frames. On : Outputs 1080 progressive 24 frames without conversion. NOTE When "I/P Direct" is set to "On" and some discs are played, no video signal is output from the video and S-Video terminals.
Color Space Sets the video signal system to be output from HDMI.	YCbCr : Outputs in the YCbCr video format. RGB Normal : Outputs using the RGB video system (16 (black) to 235 (white)). RGB Enhanced : Outputs using the RGB video system (0 (black) to 255 (white)).
Deep Color Sets the HDMI terminal to output Deep Color. Expands the color depth (number of used colors) of the HDMI video signal, enabling playback with more natural colors and free of streaking.	Auto : Deep Color is automatically output when the connected HDMI device supports Deep Color. Off : No Deep Color output.
Audio Setup Sets the audio signal system to be output from HDMI.	[Auto] : Automatically selects and outputs signals that can be input to the connected HDMI device. The bitstream signal takes priority. [Multi LPCM BM On] : Decoded Linear PCM multi-channel signal is output by the DBP-A100. Speaker settings are enabled. (BM: Bass Management) For settings, on the GUI menu, refer to, "Audio Setup" – "7.1-ch Audio Out" (page 25, 26). <ul style="list-style-type: none"> • Speaker Configuration : Sets the speaker configuration used for playback. Automatically sets channel components and characteristics according to the settings. • Channel Level : Sets the volume of the test tone to be the same when it is output from each speaker. • Distance : Sets the distance between the listening position and each speaker.

See overleaf

Remote control operation buttons



.Displays the menu
 .Cancels the menu



.Moves the cursor
 (.Up/Down/Left/Right)







:Makes the setting



:Returns to previous menu



HDMI Setup	
Setting items	Setting contents
Audio Setup	<p>[Multi LPCM BM Off] : Decoded Linear PCM multi-channel signal is output by the DBP-A100. This setting is not made in speaker settings. (BM: Bass Management)</p> <p>[2Ch] : Outputs the downmixed 2-channel LPCM signal.</p> <p>[Mute] : Does not output audio from HDMI.</p>
SA-CD Audio Out Sets to output the stereo/multi area audio of Super Audio CD to the HDMI terminal.	<p>On : Super Audio CD audio is output. Off : Super Audio CD audio is not output.</p> <p> The Super Audio CD audio signal is a 44.1 kHz/16-bit Linear PCM output.</p>
HDMI Control Can operate the unit in conjunction with an HDMI control supported device.	<p>[Control]</p> <ul style="list-style-type: none"> • Off : Disables the HDMI control function. • On : Links with the device connected to HDMI. <p>[Power Off Control]</p> <ul style="list-style-type: none"> • On : Turns the DBP-A100's power to standby through linkage to the TV. • Off : Does not turn the DBP-A100's power to standby through linkage to the TV. <p></p> <ul style="list-style-type: none"> • For the HDMI control function to operate, it is necessary for the DBP-A100 or HDMI-compatible TV connected to the DBP-A100 to have an HDMI connection. • Refer to "HDMI Control Function" ( page 449) for more information on HDMI control functions. • The HDMI control function from the connected device is enabled when, on the GUI menu, "DENON LINK Setup" – "DENON LINK Mode" is set to "4th" ( page 28). • After the "HDMI Control" setting has been changed, always turn off the power to the connected equipment and then turn it back on.

NOTE

If you set "DENON LINK Setup" – "DENON LINK Mode" on the GUI menu to "4th", you will no longer be able to change the "HDMI Control" – "Control" setting. To change the setting, switch the "DENON LINK Mode" to a setting other than "4th" first and then change the setting.



Video Setup





Default settings are underlined.

Set the video output signal according to the connected TV.

Setting items	Setting contents
TV Aspect (Aspect ratio) Set the screen type and display mode of the TV.	<p>16:9 Squeeze Auto : Outputs to a wide screen TV. For 4:3 video, displays in the center of the screen without changing the aspect ratio. *1</p> <p>WIDE (16:9) : Outputs to a wide-screen TV.</p> <p>4:3 PS : Outputs to a 4:3 TV. For wide video, trim the left and right side of the image and display in 4:3 aspect ratio. *2</p> <p>4:3 LB : Outputs to a 4:3 TV. Displays all of the wide video.</p>
Component Resolution *3 Sets the component output resolution.	<p>480/576i, 480/576P, 720P, 1080i, Source Direct : Outputs video using its source resolution. Converts a 1080p video source to 1080i.</p>
Progressive Mode Sets an appropriate progressive conversion mode for the source video material.	<p>Auto : Detects the type of video material and automatically switches the mode. Normally, this setting is used.</p> <p>Video1 : Suitable for playing video material discs.</p> <p>Video2 : Suitable for playing video material discs or 30-frame film material discs.</p>
TV Active Area Sets the horizontal display range when the analog video output resolution is 480i/576i.	<p>Full : Setting when a home-use monitor is connected.</p> <p>Normal : This setting is used when video synchronization is disturbed on a professional-use monitor.</p> <p> This is not available for HDMI output.</p>

- *1 : This has no effect on the video and S-Video outputs.
- *2 : Depending on the video content, even though you set it to 4:3 PS (Pan Scan), the content may be output in 4:3 LB (Letter Box).
- *3 : When video is output from the HDMI terminal, no video signal is output from the component terminals.

Remote control operation buttons

 .Displays the menu : Cancels the menu	 .Moves the cursor (Up/Down/Left/Right)	 :Makes the setting	 :Returns to previous menu
--	--	--	---





Audio Setup

Set the speaker or audio to be output.
 Setting related to each channel setting and other audio in the case of outputting analog audio signals decoded by the DBP-A100.

Default settings are underlined.

Setting items	Setting contents
7.1ch Audio Out Makes the audio setting for output of analog 7.1-channel audio to a multi-channel amplifier. To set "7.1ch Audio Out", set "HDMI Setup" – "Audio Setup" on the GUI menu to "2Ch" or "Mute" (page 24). NOTE You cannot select "None" or "No" for "HDMI Setup" – "Audio Setup" – "Multi LPCM BM On" – "Speaker Configuration" (page 23, 24) on the GUI menu.	<div style="border: 1px solid black; text-align: center; padding: 2px;">Multi Channel</div> Set the speaker configuration, channel level and distance for multi-channel playback. <div style="border: 1px solid black; text-align: center; padding: 2px;">2 Channel</div> Outputs multi-channel downmixed audio from the front speaker output terminals (FL/FR) of the 7.1-channel audio output terminals. Make this setting when outputting to a TV and 2-channel amplifier. NOTE The 7.1-channel audio output terminals only outputs to FL/FR when you make this setting.
	<input type="checkbox"/> Speaker Configuration : Sets the speaker configuration. [Front] : Sets the front speaker size. <ul style="list-style-type: none"> • Large : For use with large speakers that can adequately play back low frequencies. • Small : For use with small speakers that cannot adequately play back low frequencies. [Center] : Sets the presence and size of the center speaker. <ul style="list-style-type: none"> • Large : For use with large speakers that can adequately play back low frequencies. • Small : For use with small speakers that cannot adequately play back low frequencies. • None : Select when no center speaker is connected. [Subwoofer] : Sets the presence of a subwoofer. <ul style="list-style-type: none"> • Yes : Use a subwoofer. • No : Select when a subwoofer is not connected. [Surround] : Sets the presence and size of the surround speakers. <ul style="list-style-type: none"> • Large : For use with large speakers that can adequately play back low frequencies. • Small : For use with small speakers that cannot adequately play back low frequencies. • None : Select when surround speakers are not connected.

Setting items	Setting contents
7.1ch Audio Out	[Surr. Back] : Sets the presence, size and number of surround back speakers. <ul style="list-style-type: none"> • Size : Sets the surround back speaker size. Large : For use with large speakers that can adequately play back low frequencies. Small : For use with small speakers that cannot adequately play back low frequencies. None : Select when no surround back speakers are connected. • Number : Sets the number of surround back speakers. 1 spkr : Use only one surround back speaker. Surround back audio is output from the surround back L terminal. 2 spkrs : Use two surround back speakers. [Crossover Freq.] : Sets the upper limit of the low frequency signal output from the subwoofer. <ul style="list-style-type: none"> • 40Hz/60Hz/80Hz/90Hz/100Hz/110Hz/120Hz/150Hz/200Hz/250Hz : Keeps the output level below the set frequency to avoid overloading the specified low frequency performance of your subwoofer. Sets one of these frequencies according to the low frequency output capabilities of your speakers. • Advanced : Sets the low frequency signals to be output from the signals of the respective speakers to the subwoofer. Front, Center, Surround, Surr. Back 40Hz/60Hz/80Hz/90Hz/100Hz/110Hz/120Hz/150Hz/200Hz/250Hz LFE / LFE+Main 80Hz/90Hz/100Hz/110Hz/120Hz/150Hz/200Hz/250Hz  When, on the GUI menu, "Audio Setup" – "7.1ch Audio Out" – "Multi Channel" – "Speaker Configuration" – "Subwoofer" is set to "Yes" (page 25), you can select "LFE" or "LFE+Main".

See overleaf

Remote control operation buttons



Displays the menu
 Cancels the menu



Moves the cursor
 (Up/Down/Left/Right)





Makes the setting



Returns to previous menu





Audio Setup	
Setting items	Setting contents
7.1-ch Audio Out	<p>NOTE</p> <ul style="list-style-type: none"> Select "Large" or "Small" not according to the physical size of the speaker but according to the low frequency reproduction capabilities based on the frequency set at "Crossover Freq." On the GUI menu, if the "Audio Setup" – "7.1-ch Audio Out" – "Multi Channel" – "Speaker Configuration" item setting is changed, other settings are automatically changed as well. <p>[Example] If you set "Front" to "Small", "Subwoofer" is set to "Yes" and "Large" cannot be selected for "Center", "Surround" and "Surr. Back".</p> <ul style="list-style-type: none"> Audio signal (sampling frequency, number of channels) from the HDMI output terminal may be restricted by the specification of the HDMI audio that can be input by the device on the other side. <p>[Example] If the HDMI audio specification of the device on the other side is 5.1-channel, even when DBPA100 plays back in 7.1-channel, 5.1-channel audio is output automatically. In that case, the analog audio output becomes 5.1-channel output as well.</p> <p><input type="checkbox"/> Channel Level : Sets the volume of the test tone to be the same when output from each speaker.</p> <p>[Mode] : Select a test tone output method.</p> <ul style="list-style-type: none"> Auto : Automatically switches the test tone output speaker. Manual : Manually switches the test tone output speaker. <p>[Start] : Begins outputting the test tone. Front L / Center / Front R / Surround R / Surr. Back R / Surr. Back L / Surround L / Subwoofer</p> <p>※ When the test tone output stops, press .</p> <p>[SW +10dB] : Increases the subwoofer output level by 10 dB. *</p> <ul style="list-style-type: none"> Off : Does not change the subwoofer output level. On : Increases the subwoofer output level by +10 dB. <p>* : "SW +10dB" cannot be set for "HDMI Setup" – "Audio Setup" – "Multi LPCM BM On" – "Channel Level" on the GUI menu.</p> <p>[Default] : Resets all channel level settings to factory default.</p> <ul style="list-style-type: none"> No : Does not Reset. Yes : Resets.
	<p>7.1ch Audio Out</p> <p><input type="checkbox"/> Distance : Sets the distance between the listening position and each speaker. [Feet] or [Meters] : Set the unit of distance. [Step] : Set the minimum variable width of the distance. 1ft, 0.1ft, 0.1m, 0.01m [Default] : Reset all distance settings to factory default.</p> <p>Front L / Front R / Center / Subwoofer / Surround L / Surround R / Surr. Back L / Surr. Back R : Select the speaker you want to set, and set the distance. Set the value that is closest to the measured distance. 0 ~ 60ft or 0 ~ 18m</p> <p></p> <ul style="list-style-type: none"> Default settings : Front/Center/Subwoofer : 12 feet (3.6 meters) Surround/Surr. Back : 10 feet (3.0 meters) Set the difference in the distance between the speakers to less than 20 feet (6.0 meters). <p>NOTE When "BD Audio Mode" is set to "HD Audio Output" ( page 32), the "Distance" setting is disabled during DTS-HD 192kHz audio playback.</p> <p>Subwoofer Mode Sets the type of low frequency signal to be output from the subwoofer.</p> <p>LFE : Adds the low frequency signal of the channel for which the speaker size is set to "small" to the subwoofer signal and outputs it. LFE+Main : Adds the low frequency signal of all channels to the subwoofer signal and outputs it.</p>



Audio Setup

Setting items	Setting contents
<p>Source Direct Disables the speaker and subwoofer settings and outputs the disc audio as is.</p> <p>NOTE Set to within the playback frequency band of the amplifier you will use: "On" at "50 kHz" or "100 kHz". Settings outside the frequency band can result in damage to your amplifier and even fire.</p>	<p>Off : Enables the speaker and subwoofer settings. On : 50kHz : Outputs the disc content as is. When playing Super Audio CD, outputs up to 50 kHz audio signals. On : 100kHz : Outputs the disc content as is. When playing Super Audio CD, outputs up to 100 kHz audio signals.</p> <p> • Setting "On: 50 kHz" or "On: 100 kHz" enables full-range playback on all channels recommended for DTS. (Note that this results in a 5 dB increase in subwoofer volume, and a 15 dB increase with Super Audio CDs). This also allows you to play back the 6-channel source of DVD-Audio recorded on all channels with the full frequency range. In this case, make analog connections according to the disc operating manual. • When set to "On: 50 kHz" or "On: 100 kHz", all speaker sizes are set to "Large" and "Yes" is set for the subwoofer. • Even when set to "On: 50 kHz" or "On: 100 kHz", the "Channel Level" and "Distance" settings can be made.</p>
<p>Compression Compresses the dynamic range of Dolby TrueHD/Dolby Digital/Dolby Digital Plus audio. At night or other times when you cannot play back at high volume, this compensates by reducing high level sounds and increasing low level sounds.</p>	<p>Auto : Automatically compresses the Dolby TrueHD audio dynamic range. The sound is not compressed when playing signals other than Dolby TrueHD signals. Off : Dynamic Range compression is not applied. Low : Sets minimum dynamic range compression. Middle : Sets medium dynamic range compression. High : Sets maximum dynamic range compression.</p>
<p>BD Effect Sound Sets for a clicking and other sound outputs during BD popup menu operation.</p>	<p>On : Outputs BD effect sound. Off : Does not output BD effect sound.</p>

Setting items	Setting contents
<p>BD Re-Encoder Sets the format during output of the BD's Mix Audio signal from the digital output terminal.</p>	<p>Auto : Outputs the primary audio (main audio) in the same type of audio format. Dolby Digital/Dolby Digital Plus/Dolby TrueHD are output as Dolby Digital, DTS/DTS-HD are output as DTS and Linear PCM is output as Linear PCM. Dolby Digital: Outputs to the digital audio output terminal (optical/coaxial) with Dolby Digital. DTS : Outputs to the digital audio output terminal (optical/coaxial) with DTS.</p> <p> Valid when "BD Audio Mode" is set to "Mix Audio Output" (👉 page 32).</p>
<p>Digital Out Sets the audio signal of digital audio output. For more information on each audio signal, refer to "Audio Signal from the Digital Audio Output (Optical/Coaxial Terminal)" (👉 page 17).</p>	<p>Bitstream : Outputs a bitstream signal. Converts Dolby TrueHD, Dolby Digital Plus to Dolby Digital, and DTS-HD to DTS for output. PCM : Outputs the downmixed audio signal to 2-ch LPCM. PCM Down Sampling : Converts sampling frequency audio greater than 48 kHz to a 48 kHz 2-ch LPCM audio output signal.</p> <p> • When outputting CD, etc. to a digital recording device, such as a CD recorder, convert to PCM or PCM down sampling. • When a disc with recorded Linear PCM or PPCM (Packed PCM) is played back, this outputs Linear PCM regardless of the setting.</p>
<p>Downmix Sets the method used to convert a multi-channel audio signal to a 2-channel signal.</p>	<p>Lt/Rt : Signals are converted to Dolby Surround compatible 2-channel audio signals for output. This setting is valid for DTS-HD, DTS Digital Surround, Dolby Digital Plus and Dolby Digital audio signals. (If the connected AV Amp is Dolby Pro Logic compatible, the AV Amp plays back using surround audio.) Stereo : Outputs by converting to 2-ch (stereo) audio.</p> <p>NOTE In order to enable the "Lt/Rt" setting when playing back BD, set "BD Audio Mode" to "HD Audio Output" (👉 page 32).</p>

Remote control operation buttons



Displays the menu
Cancels the menu



Moves the cursor
(Up/Down/Left/Right)



:Makes the setting



:Returns to previous menu





DENON LINK Setup

Default settings are underlined.

Set the audio signal to be output from the DENON LINK terminal.

Setting items	Setting contents
DENON LINK Mode Sets the audio output of DENON LINK.	<p>[Off] : Does not use DENON LINK.</p> <p>[2nd] : Outputs digital audio using DENON LINK 2nd.</p> <p>[3rd] : Outputs digital audio using DENON LINK 3rd.</p> <p>[4th] : Outputs digital audio using DENON LINK 4th.</p> <p>Compatible with jitter-free connections. For more information, refer to "DENON LINK Connection ① Making a Jitter-free Connection" (page 17).</p> <ul style="list-style-type: none"> • HDMI : Improves HDMI digital signal jitter. <p></p> <ul style="list-style-type: none"> • When set to "4th", the HDMI control function becomes available from the connected device. • When "4th" is set and jitter-free connection is set up, audio affected by the jitter-free function is output from the HDMI terminal during BD playback. When playing back media other than that, the video signal is output from the HDMI terminal and the audio signal is output from the DENON LINK terminal, respectively. • To play DENON LINK 4th signals, connect to a DENON LINK 4th-compatible AV Amp using an HDMI and a DENON LINK cable. • For information on the 4th setting of the AV Amp, see the owner's manual of the AV Amp.

□ Signals Compatible with DENON LINK Setting and Transmission

The DENON LINK setting for the DENON LINK version of the connected AV Amp is as follows:

DENON LINK version of AV Amp	The DENON LINK setting of the DBP-A100	Media					
		BD (During jitter-free connection)	DVD-Video	DVD-Audio	Super audio CD	CD	SD
2nd Generation ("2nd" displayed near terminal)	"2nd"	×	○	○	×	○	○
3rd Generation ("3rd" displayed near terminal)	"3rd"	×	○	○	○	○	○
4th Generation ("4th" displayed near terminal)	"4th"	○	○	○	○	○	○

NOTE

With DENON LINK connections, no audio signals other than those of BD are output from the HDMI terminal.
 (When "DENON LINK Mode" is set to "2nd" and "HDMI Setup" – "SA-CD Audio Out" (page 24) is set to "On", the audio signals of Super Audio CD are output from the HDMI terminal.)



Pure Direct Setup

Default settings are underlined>.

Makes settings for digital audio and video output modes during Pure Direct mode, as well as for display messages. Two types of setting can be made.

Setting items	Setting contents
User Preset 1/ User Preset 2 Sets the operating mode for "User Preset 1" or "User Preset 2" selected by . Setting each of these items to "Off" enables output of high quality analog signals free of interference from their associated circuits.	<p>[Digital Out] : Sets whether to output signals to the digital audio output terminal.</p> <ul style="list-style-type: none"> • On : Enables digital audio output. • Off : Disables digital audio output. <p>[Video Out] : Sets the option of video output.</p> <ul style="list-style-type: none"> • On : Enables video output. • Off : Disables video output. This setting also disables audio output from the HDMI terminal. <p>[Display] : Set the option for front panel display.</p> <ul style="list-style-type: none"> • On : Turns on the display. • Off : Turns off the display. <p></p> <p>For more information, see "Playing Back High-quality Audio (Pure Direct Function)" (page 38).</p>

Remote control operation buttons



Displays the menu
Cancels the menu



Moves the cursor (Up/Down/Left/Right)



Makes the setting



Returns to previous menu



Ratings

Default settings are underlined>.

Set BD or DVD parental lock or display DivX® registration codes.

Setting items	Setting contents
Password Sets the password for changing the parental control level and parental control country code of BD and DVD.	Change : Changes the password. Use <u>0</u> ~ <u>9</u> to enter a password and then press to finalize it. The default setting is "0000".
BD Rating Level Sets the parental level for playing BD.	Level 0 ~ 254 : Sets the age allowed to play back media. Restricts playback of discs with relevant parental control. No Limit : Does not restrict playing of BDs.
DVD Rating Level Sets the parental level for playing DVDs.	Level1 ~ 8 : Sets the parental level for playing DVDs. Lock All : Restricts playing of all DVDs. No Limit : Does not restrict playing of DVDs.
Rating Country Code Sets the standard country parental control. Applies the parental level of the set country.	Argentina / Australia / Austria / Belgium / Brazil / Canada / Chile / China / Denmark / Finland / France / Germany / Hong Kong / India / Indonesia / Italy / Japan / Korea, Republic of / Malaysia / Mexico / Netherlands / New Zealand / Norway / Pakistan / Philippines / Portugal / Russian Federation / Singapore / Spain / Switzerland / Sweden / Taiwan / Thailand / United Kingdom / United States / Colombia / Greece / Ireland / Luxembourg / Poland Others : Input the country code. Refer to "Country Code List" (page 52) and use and on the virtual keyboard to input the country code.
DivX Registration Displays the DivX® registration code.	Show Code : Displays the DivX® registration code



Network Setup

Default settings are underlined>.

Settings for connecting to the Internet.

You can use a disc which offers BD-LIVE functions by connecting the unit to the Internet (page 36).

To obtain update support for your DBP-A100, you can download the latest firmware from our website.

Follow the instructions in "Connecting to the Network" (page 19) to make network connections.

Setting items	Setting contents
DHCP Sets how to perform network configuration, automatically or manually. 	[On] : Automatically configures the network via the DHCP function. [Off] : When connecting to a network that lacks the DHCP function, manually configure the following network settings. Consult with the ISP or your network administrator for what settings to make. Use <u>0</u> ~ <u>9</u> to enter values and then press to finalize them.
Since the factory default setting is "On", you do not need to set items such as the IP address if the DHCP server of the broadband router is set to "Enable". Configure a proxy server if necessary.	<ul style="list-style-type: none"> • IP Address (BD-LIVE, Update) : Manually configure the IP address for BD-LIVE or Firmware Updates. • IP Address (Control) : This is a configuration for future extensions. Usually it is not necessary to configure this. • Subnet Mask : If a xDSL modem or terminal adaptor is directly connected to the DBP-A100, enter the subnet mask provided by the ISP, usually in a document. Usually, "255.255.255.0" is set. • Default Gateway : If the device is connected to a gateway (router), enter its IP address. • Primary DNS : Enter the primary DNS. • Secondary DNS : Enter the secondary DNS.
Proxy Setting for connecting to the Internet via a proxy server.	[Off] Does not use a proxy server. [On (Address)] Set to connect to the Internet via a proxy server. Use the address to specify the proxy server. Use <u>0</u> ~ <u>9</u> to enter the address and then press to finalize it.
	<ul style="list-style-type: none"> • Port : Use <u>0</u> ~ <u>9</u> to enter the port number and then press to finalize it. [On (Name)] Set to connect to the Internet via a proxy server. Specify the proxy server using the domain name. Input the domain name with the virtual keyboard, using and .
	<ul style="list-style-type: none"> • Port : Use <u>0</u> ~ <u>9</u> to enter the port number and then press to finalize it.

Remote control operation buttons



Displays the menu
Cancels the menu



Moves the cursor
(Up/Down/Left/Right)



Makes the setting



Returns to previous menu

Network Setup

Setting items	Setting contents
IP Address	BD-LIVE, Firmware Update : Displays the IP address for BD-LIVE or Firmware Updates. Control : Displays the IP address for future extensions.
MAC Address	BD-LIVE, Firmware Update : Displays the MAC address for BD-LIVE or Firmware Updates. Control : Displays the MAC address for future extensions.



Display Setup

Default settings are underlined>.

Settings for display-related items.

Setting items	Setting contents
Screen Saver Sets the screensaver.	Off : Does not use the screensaver. On : The screensaver function activates when stop or pause status continues for about three minutes. The screensaver function also activates during playback of a CD, Super Audio CD or audio file when no operations are performed for about three minutes.
Wallpaper Setting for displaying the background when playback is stopped.	Picture : Displays the DENON logo. Black : Sets the background to black. Gray : Sets the background to gray. Blue : Sets the background to blue.
Still Mode Sets image quality when paused.	Automatic : Displays automatically using "Field" or "Frame" according to the still image information. Field : Set when there is a blurred image when "Automatic" image display is set. Frame : Set to display non-moving images in high resolution.
Slide Show Time Sets the display time of JPEG files.	3 ~ 5 ~ 100sec : This sets how long to display each frame of a JPEG file during slideshow playback.
Temporary Display When the display is set to "Off" by the Dimmer Control (page 47) or Pure Direct Function (page 38), this sets it to temporarily display operations received.	Off : Does not temporarily display operations. On : Temporarily displays operations.
Captions This setting outputs a subtitles signal to a closed caption decoder (sold separately).	Off : Does not output the closed caption (subtitle) signal. On : Outputs the closed caption (subtitle) signal.



Displays the menu
Cancels the menu



Moves the cursor
(Up/Down/Left/Right)



:Makes the setting



:Returns to previous menu



Other Setup

Sets other items.

Default settings are underlined>.

Setting items	Setting contents
Auto Power Mode This setting automatically sets the power to standby.	Off : Does not use the auto power mode. On : This setting automatically sets the power to standby if any of the following states continues for approximately 30 minutes. <ul style="list-style-type: none"> • Disc not loaded • Playback stopped • Stopped due to the resume function
Power Saving Sets to power saving mode during standby.	Power Saving Standby : This is the lowest power consumption mode. During standby, operations are not accepted via HDMI control or RS-232C. Power indicator status in standby mode : Off Normal Standby : During standby, operations are accepted via RS-232C. Power consumption is slightly higher at this time. Power indicator status in standby mode : Red Quick Start Mode : Start up time is faster but power consumption during standby is higher. Operations are accepted via HDMI Control and RS-232C. Power indicator status in standby mode : Red
Remote Control Setting (Main unit side) Sets the remote control.	[Remote ID] Switches the DBP-A100's remote control ID code when other DENON BD Players are in the vicinity. <ul style="list-style-type: none"> • DENON 1 : Set the switch in the remote control battery compartment to "1" as well ("Remote Control Settings (Remote Control Side)" page 7). • DENON 2 : Set the switch in the remote control battery compartment to "2" as well ("Remote Control Settings (Remote Control Side)" page 7). [Receive Existing Remote Control] Set whether or not to accept remote control signals of a DENON DVD player or other device. <ul style="list-style-type: none"> • On : Accepts • Off : Does not accept
BD Data Utility Erases data on SD Memory Card, and initializes cards.	BD Data Erase : Erases both internal memory and SD Memory Card storage. Initialize SD Card : Initializes the SD card to be used for the Bonus View and BD-LIVE functions. <p>NOTE</p> <ul style="list-style-type: none"> • Insert or remove a SD Memory Card while the power is in standby. If the SD Memory Card is inserted when the power is switched on, there are occasions where the card cannot be read, or the BD cannot be played. • The SD card used for the Bonus View function must have a capacity of 1GB or greater. Also the SD card must be initialized on the DBP-A100. • This operation will delete all the data. Do not perform this operation when an SD card containing MP3 or JPEG data is inserted. • Remove the disc from the disc tray when carrying out "BD Data Erase" or "Initialize SD Card".

Setting items	Setting contents
Initialize All settings including audio mode and picture quality are set to default settings.	Cancel : Does not initialize. OK : Executes initialization.
Firmware Update Updates the firmware of the unit via the Internet.	Check for Update : Checks if a newer version of firmware exists. You can also check approximately how long it will take to complete an update. Start : Starts firmware update. When updating starts, the power indicator lights red and the GUI screen shuts down. While updating, a rough estimate of remaining time is indicated on the display. When updating is complete the power indicator lights green and the normal status is resumed.
Information Displays the license for the IPA font used by this product.	[Font License] Japanese (Original) : Displays in Japanese. The font used in this product's GUI menu screen conforms to IPA font specifications. See the following URL for the IPA font license agreement. http://ipafont.ipa.go.jp/enduser_license.html
Maintenance Mode Use when receiving maintenance from a DENON service engineer or custom installer.	<p>NOTE</p> Only use this function if so instructed by a DENON service person or installer.

Cautions on "Firmware Update"
<ul style="list-style-type: none"> • In order to use these functions, you must have the correct system requirements and settings for a broadband Internet connection (page 19, 29). • Do not turn off the power until updating is complete. • Information regarding the "Firmware Update" function will be announced on the DENON web site each time related plans are decided. • Even with a broadband connection to the Internet, approximately 1 hour is required to complete the updating procedure. Once updating starts, you cannot perform normal operations on the DBP-A100 until updating is complete. Also, settings of the GUI menu of DBP-A100 and/or image adjustment settings may be initialized. • If a disc is in the tray, remove it before performing "Firmware Update".

Remote control operation buttons



Displays the menu
Cancels the menu



Moves the cursor
(Up/Down/Left/Right)



:Makes the setting



:Returns to previous menu



Various Settings

You can set the audio mode and switch the kind of files to play. You can make various mode settings during playback. The setting menu is displayed at the top of the screen.

1 Press . Displays a menu of items that can be set.



※ The display content changes depending on the media being played.

2 Select a setting item using , and then press or .

3 Use to select a setting and use to change the setting.

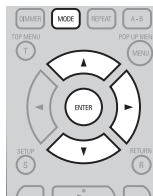

Setting the Audio Mode Default settings are underlined.

Setting items	Setting contents
BD Audio Mode Switches the BD audio playback mode.	<p>HD Audio Output : Can view by outputting high quality signals such as Dolby TrueHD, Dolby Digital Plus, or DTS-HD as its high sound quality bitstream. Cannot listen to interactive or secondary audio.</p> <p>Mix Audio Output : Outputs a mix of primary audio/interactive audio/secondary audio.</p> <p>NOTE When "BD Audio Mode" is set to "Mix Audio Output", DTS-HD 192kHz audio is decoded to 96kHz.</p>

Changing the Playback File Display Default settings are underlined.

Setting items	Setting contents
File filter Selects the file formats you wish to play from among the files mixed on a disc.	<p>All : Plays MP3/WMA/AAC/LPCM/JPEG/DivX[®] files.</p> <p>Audio : Plays MP3/WMA/AAC/LPCM files.</p> <p>Picture : Plays JPEG files.</p> <p>Video : Plays DivX[®] files.</p> <p>Audio & Picture : Plays MP3/WMA/AAC/LPCM/JPEG files.</p> <p> This operation is effective only when playback is stopped.</p>

Making Other Settings Default settings are underlined.

Setting items	Setting contents
Secondary Video (PIP)	<p>Off : Does not display Secondary Video(Picture-In-picture).</p> <p>1/X* : Displays the first Secondary Video.</p> <p>2/X* : Displays the second Secondary Video.</p> <p>X/X* : Displays the X th Secondary Video.</p> <p>*:"X" is the number of Secondary Videos recorded and differs depending on the disc ("Playing Bonus View" page 36)</p>
Audio/Video Sync Corrects displaced video-audio playback timing.	<p>HDMI / Component : Audio output is synchronized to the video output from the HDMI terminal or component terminals.</p> <p>S-Video / Video : Audio output is synchronized to the video output from the S-Video or Video terminals.</p>
Audio Delay Adjust While viewing video, manually adjust the time to delay audio output.	<p>0 ~ 200msec : Use this to adjust the audio output delay time manually.</p>
Vertical Stretch Extends the cinemascope size video vertically.	<p>Off : Displays the source video signal without modification. This should normally be set to "Off".</p> <p>On : Set when viewing cinemascope size video with a combination of projector and anamorphic lens. Extends the image vertically so that the top and bottom black portions disappear.</p> <p>NOTE This has no effect with the video and S-Video outputs.</p>

Adjusting the Picture Quality (Picture Control)

You can adjust the picture quality to your liking.
You can store up to a maximum of 5 values in memory.

1 Press .
The currently set status is displayed.

2 Select the memory number you want (“Memory 1” ~ “Memory 5”) with , and then press .



3 Select the item(s) you wish to change with .



4 Change the setting with .

※ Refer to the table on the right for information on the different settings.

❑ To Finalize Picture Adjustments

Press with the picture adjusted.

❑ When Outputting Standard Picture Quality without Using Picture Adjustment

Press and to select “Standard” and then press .



The picture adjustment settings are retained in memory even after the power is turned off.

Setting items	Setting contents	Default
DNR Reduces noise in the entire picture.	0 ~ +3	0
Contrast Adjusts picture contrast.	-6 ~ +6	0
Brightness Adjusts picture brightness.	0 ~ +12	0
Enhancer *3 Strengthens the contours of the picture.	0 ~ +11	0
Gamma Correction *1 Adjusts video brightness in detail.	G0 ~ 9	G0 = 24 / G1 = 32 G2 = 48 / G3 = 64 G4 = 80 / G5 = 96 G6 = 128 / G7 = 160 G8 = 192 / G9 = 224
Sharpness (medium range) *1, 3 Adjusts picture sharpness for the medium frequency range.	-6 ~ +6	0
Sharpness (high range) *3 Adjusts picture sharpness for the higher frequency range.	-6 ~ +6	0
Hue (color tone) *4 Adjusts the green and red color balance.	-6 ~ +6	0
White Level Adjusts the white level.	-5 ~ +5	0
Black Level *3 Adjusts the black level.	-5 ~ +5	0
Chroma Level Adjusts the color density.	-6 ~ +6	0
Setup Level *2 Adjusts the black areas of the image.	0 IRE 7.5 IRE	7.5 IRE
H.Position *3 Adjusts the left/right position.	-7 ~ +7	0
V.Position *3 Adjusts the top/bottom position.	-7 ~ +7	0

- *1: This is not available for HDMI output.
- *2: Effective only for the 480i video signal from the video output terminal, S video output terminal, and component video output terminal.
- *3: This has no effect with the video and S-Video outputs.
- *4: This has no effect with the video and S-Video outputs when playing PAL video.

Gamma Correction

When you select “Gamma Correction”, and then press , you can change the setting with .

In the example of the graph below, the horizontal axis shows the brightness level of the picture recorded on the disc. The vertical axis shows the brightness of the picture output by the DBPA100.

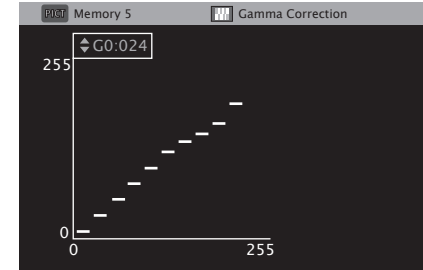

- When the brighter areas on the disc side are adjusted to be output darker, the normally hard to see bright parts become clearly discernible images.

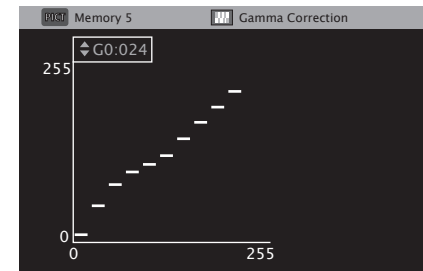

- When the darker areas on the disc side are adjusted to be output brighter, the normally hard to see dark parts become clearly discernible images.

❑ Resuming Initial Values after Gamma Correction

Press while the graph is displayed.



Playback

Playing Discs

- ❑ Playing BD and DVD-Videos (👉 page 36)
- ❑ Playing Super Audio CDs (👉 page 37)
- ❑ Playing CDs (👉 page 37)
- ❑ Playing DVD-Audio (👉 page 37, 38)
- ❑ Playing High-Quality Audio (👉 page 38)

Playing Files

- ❑ Playing Files (👉 page 38 ~ 40)

Operations Enabled During Playback (👉 page 41)

Web control function (👉 page 47,48)

NOTE

- The symbol “⊘” (prohibited mark) may appear on the top right of the TV screen during an operation. This means that the operation being conducted is prohibited.
- Depending on the disc, certain operations may not be as described in this manual. Check each disc owner’s manual for more information.
- During playback of a 2-layered disc, pictures may stop momentarily. This happens when the 1st layer switches to the 2nd layer. This is not a malfunction.

Introduction

Before Playing a Disc

1 Turn on the power of the amplifier and TV.
Set the TV and amplifier source to DBP-A100 input.

2 Turn the DBP-A100 on.

※ When you wish to play a bonus view, before turning the DBP-A100 on insert a SD Memory Card that has at least 1GB and has been initialized by DBP-A100.

3 Press **SOURCE to set the playback media mode to “DISC MODE”.**

4 Insert a disc.

- Press **OPEN/CLOSE** to open/close the disc tray.
- Insert the disc with the side you want to play face down.



Before Playing an SD Memory Card

1 Turn on the power of the amplifier and TV.
Set the TV and amplifier source to DBP-A100 input.

2 Insert a SD Memory Card.
Insert the SD Memory Card in the direction indicated by the arrow with the label side up (👉 page 6, 8).

3 Turn the DBP-A100 on.

4 Press **SOURCE to set the playback media mode to “SD CARD MODE”.**



The playback media mode setting remains in memory, even when the power is set to standby.

About Playback Information

The displayed playback information toggles between the information bar and the media player screen each time **DISPLAY** is pressed. To close the display, press **DISPLAY** until it goes away.



※ Displayed content differs depending on the media being played. Also, the information displayed while playing and stopped differs.

Information Bar Display

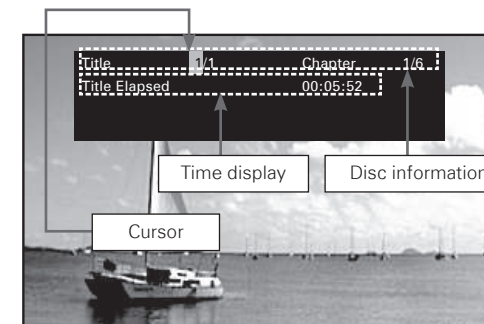

※ Displayed inside the frame at the top of the screen. (See the next page.)

❑ Disc Information Display

- **Title** Title being played/total number of titles
- **Chapter** Chapter being played/total number of chapters
- **Group** Group being played/total number of groups
- **Track** Track being played/total number of tracks

❑ Time Display

- **Title Elapsed**
- **Title Remain**
- **Chapter Elapsed**
- **Chapter Remain**
- **Group Elapsed**
- **Group Remain**
- **Track Elapsed**
- **Track Remain**

❑ HDMI Output Signal Display

- **Video Info** Video output signal format/resolution
- **Audio Info** Audio format being output
- **Max Channel** Number of audio channels that the connected device can receive

Searching with the Information Bar

When you enter a number to find in the orange cursor area, that location is found. You can search in four modes, "Title", "Chapter", "Group" and "Track search".

1 Use to move the cursor to the item that you wish to find.

2 Use 0 ~ 9 and +10 to enter a value.

3 Press . The search is executed and playback begins.

※ If the input number information is not on the disc, the current playback display reappears.

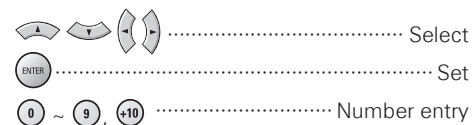

Media Player Display

SA-CD CD MP3 WMA AAC LPCM

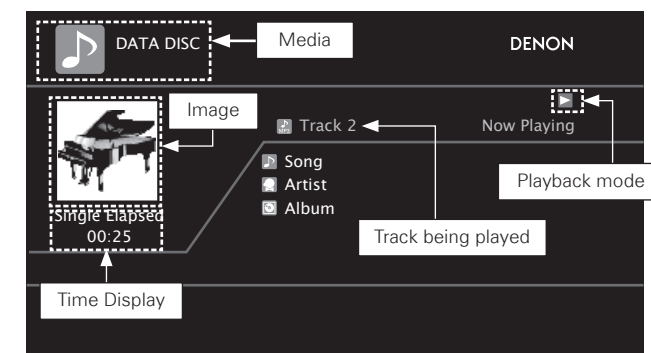

❑ Disc Information Display

SA-CD MP3 WMA AAC

- Title
- Artist name
- Album title



For information on the time display and the HDMI output signal display, see "Information Bar Display" (👉 page 34).

Playing BDs and DVD-Videos

1 Playback preparation (“Before Playing a Disc” page 34).

2 Make the various settings for playback on the disc menu.

Select
Playback



- You can make the following settings on the disc menu. (The items you can set differ depending on the contents of your disc.)
 - Subtitle language
 - Audio language
 - Audio format etc.
- When playing a BD hybrid disc, the disc layer can be changed to “BD layer” or “DVD layer” by pressing **DISC LAYER**.
- During DVD-Video playback, press **TOP MENU** or **POPUP MENU** to display the menu.
- If the menu continues, press **SELECT** to get to the next part.

3 Select the playback title or chapter from the top menu for playback.

Select
Playback
Playback

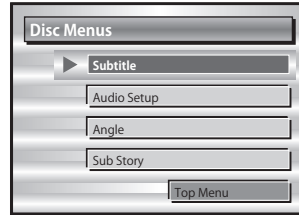

[Example] Disc menu

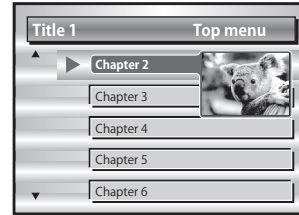

[Example] Top menu

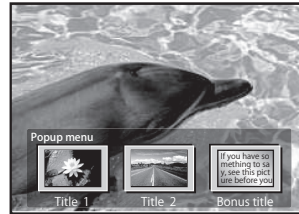

[Example] Popup menu

With BD, depending on the disc, you can select title and chapter from the popup menu.

Enjoying BD-LIVE features

- The functions that can be used with BD-LIVE differ from disc to disc. For details on the functions and how to operate them, see the individual disc’s on-screen displays and explanations.
- An SD card must be loaded in the DBP-A100 in order to save downloaded contents for using BD-LIVE functions. Use an SD card with a capacity of 1 GB or greater. Also, the SD card must be formatted on the DBP-A100.
- Do not remove the SD card from the DBP-A100 while playing a BD-LIVE compatible disc.

Playing BD-Videos Compatible with Bonus View

- With a disc that is compatible with bonus view (picture-in-picture), in addition to the main video (primary video) stored on the disc, you can play back the video director’s commentary and simultaneously ongoing sub-story, as well as sub-video such as alternative camera angles (secondary video).
- Some BD discs use SD cards as the recording memory for Bonus View playback. With the DBP-A100 is in standby, insert the SD Memory Card before playing the disc.
- The playback method, etc., is determined by the disc, and varies depending on the disc. Refer to the operation guide of the relevant disc.

Playing Bonus Views

Press **MODE** to select the secondary video display you wish to play.

Off → 1/X → 2/X → X/X

[Selectable item]

Off : Does not display Secondary Video.

1/X * : Displays the first Secondary Video .

2/X * : Displays the second Secondary Video.

X/X * : Displays the X th Secondary Video.

*: “X” is the number of Secondary Videos recorded and differs depending on the disc.



Main video
(primary video)

Sub video
(secondary video)

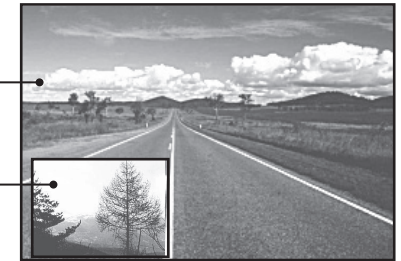

[Example] Bonus view

NOTE

- Insert or remove a SD Memory Card while the power is in standby. If you insert a SD Memory Card while the power is ON, the SD Memory Card may not be read.
- The SD card used for the BD-LIVE and Bonus View Functions must have a capacity of 1GB or greater. Also the SD card must be initialized on the DBP-A100 (page 31).
- To use BD-LIVE functions, connect the DBP-A100 to the Internet and make the settings described below, as necessary: Connections.....“Connecting to the Network” (page 19) Settings.....“Network Setup” (page 29)
- Depending on your network environment, it may take time to connect to the network or connection may not be possible.
- Remove the write protection of the SD Memory card.

Playing Super Audio CDs

SA-CD

1 Playback preparation (“Before Playing a Disc”
 (page 34).

2 Select the playback area and layer with
 DISC LAYER.

Multi : Plays the multi-channel area of the HD layer.

Stereo : Plays the 2-channel area of the HD layer.

CD : Plays the CD layer.

※ Pressing  plays the selected area/layer.



When Viewing the Text or Playback Time Display
 See “Media Player Display” (page 35).



- If you play a disc that does not have the area or layer you selected, choose the playback area or layer to play in the order “Multi”, “Stereo”, “CD”.
- The area/layer selected with DISC LAYER remains in the memory even when the power is turned off.

Playing CDs

CD

1 Playback preparation (“Before Playing a Disc”
 (page 34).

2 Press  .
 Playback begins.



When Viewing the Playback Time Display
 See “Media Player Display” (page 35).

Playing DVD-Audio

DVD-A

1 Playback preparation (“Before Playing a Disc”
 (page 34).

2 Select the part to play with DISC LAYER.

Audio : Plays the audio part.

Video : Plays the video part.

3 If a top menu is available, select the playback group and track from the top menu, and then play the disc.

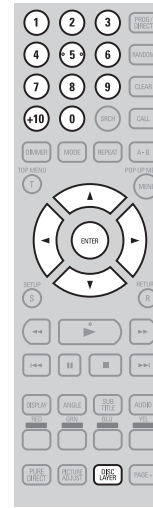



When Viewing the Text or Playback Time Display
 See “Information Bar Display” (page 34).

Changing the Group/Track

1 While stopped or during playback, select the search mode with  .
 The search mode is displayed in the top-right of the screen.

※ The search mode changes each time you press  .

Group search mode   Track search mode

2 Select the playback group and track from the top menu, and then play the disc.

 , 

Plays the group or track of the pressed number.
 ※ See “Looking for Specific Sections with the Search Modes” (page 42) for instructions on inputting numbers.



The search mode selected with this operation is memorized until the unit goes into standby or the disc tray is opened.

Playing DVD-Audio

Playing Bonus Group

DVD-Audio discs may have a bonus group that can be played after entering a password.

1 While stopped, select “Group” with **SRCH**.

2 Enter the bonus group number with **0** ~ **9**, **+10**.



3 Using **0** ~ **9** enter the 4-digit password, and then press **ENTER**.

Playback will begin from the 1st track of the selected group.

※ The password may also be entered on the menu screen by following the on-screen instructions.



❑ **If you enter the wrong password**

Press **CLEAR** to erase the input number and then enter the correct number.



Selecting Still Images

When a DVD-Audio disc has still images on it, you can choose the image to display.

Press **PAGE** during playback.

The next still image is displayed.



Playing High-Quality Audio (Pure Direct Function)



This enables you to play high quality audio by stopping the video signal, etc., output, and outputting the analog audio signal only.

Press **PURE DIRECT** while stopped and then select the pure direct mode.



Off : This turns off the pure direct function.

On : This turns off the digital signal output, video signal output and display on the display screen.

User Preset 1 : Operates with the registered pure direct setting.

User Preset 2 (“Pure Direct Setup” page 28)



- You cannot use **PURE DIRECT** while the GUI menu is displayed.
- With Pure Direct on and the main unit display set to off, indicators other than power are turned off.
- The pure direct setting returns to “Off” when the DBP-A100 is put in standby mode.

Playing Files

❑ **About the File Display**

Limits to the number of folders and files that can be displayed by the DBP-A100 are as follows.

(The limited number includes the root folder.)

- Number of folder directory levels8 levels
- Number of folders 999
- Number of files 9999
- Number characters per
 - File name, Folder name 32
 - Artist name, title, etc. 60

※ Text longer than one line is scroll-displayed.

※ If characters not supported on the menu screen are included in a file name, title, artist name or album title, they are not displayed correctly.

Playing Files



1 Turn the DBP-A100 on.

2 Press **SOURCE**, and select the playback media mode.

DISC MODE : Plays discs

SD CARD MODE : Plays SD memory cards

3 Load media.
The file browser screen will appear.

※ See “Inserting a Disc” and “Inserting an SD Memory Card” (page 6) for how to load media

※ If file browser screen does not appear, press **MENU**.

4 Select the folder of the data to be played and press **ENTER**.



5 Press **PROG/DIRECT** to select a playback mode.

All Track Mode : Plays back all files on the media.

Folder Mode : Plays back files in the selected folder. The folder icon is displayed in the playback mode indicator.

6 Selecting and playing files.

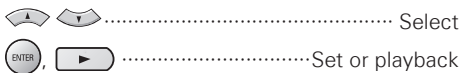

Operation during playback differs depending on the file being played. See “Operation During Playback” (page 40).

About folder and file displays

File Browser Screen

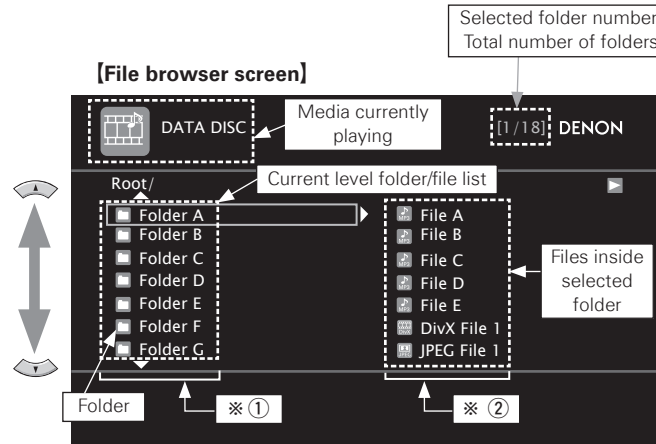

[Item selected screen]

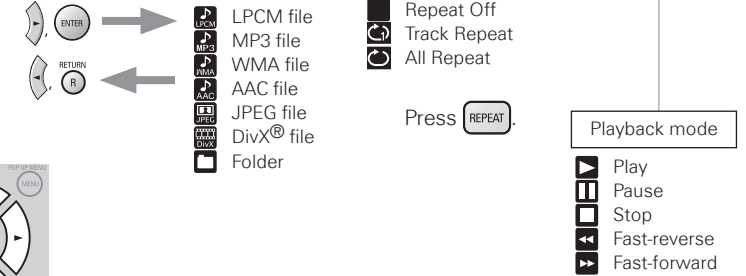
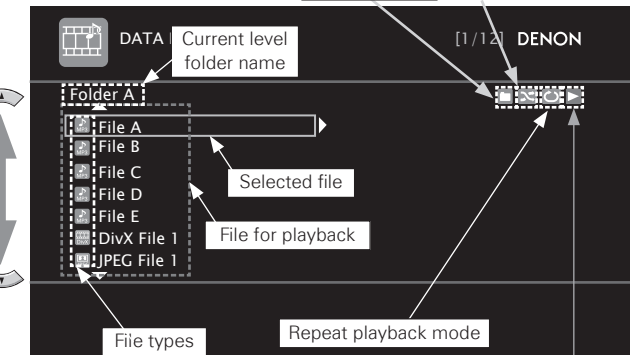

To Switch the Page Displayed

Press **▶▶** to display the next page.
Press **◀◀** to display the previous page.

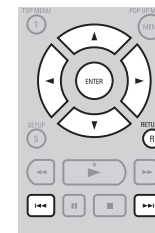

For information on playable media and files, see “Playable Media” (page 3, 4).

File Playback

Screen Display During Playback

Display during Playback of Audio Files

Displays the JPEG image data of cover art, etc., recorded on the file being played.

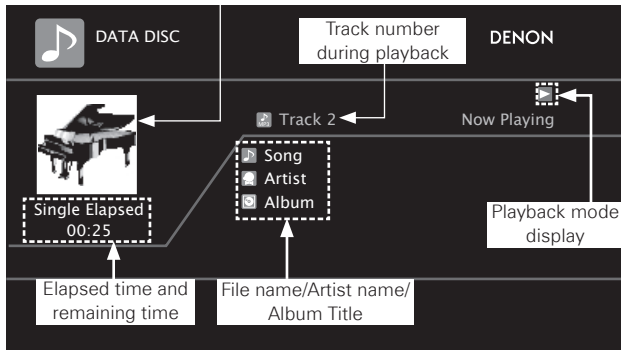

NOTE

The display of JPEG image data of cover art, etc., recorded on the file being played is enabled when playing MP3 and AAC audio files.

Display of DivX® Files and JPEG Files

Displays video being played.



Displays still image being played

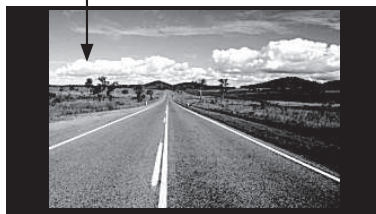

Operation During Playback

Audio file and DivX® file operation

MP3 WMA AAC LPCM DivX

Playback in Any Order (Random Playback)

Press **RANDOM** while stopped and then press **ENTER** or **▶**.

Playing Back Repeatedly (Repeat Playback)

Press **REPEAT** to select the repeat playback mode.

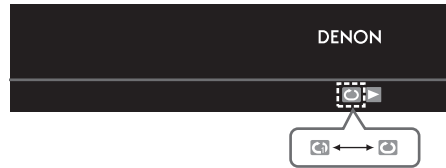

Playing JPEG Files (Still Image)

JPEG

Slide-show playback of JPEG still image files stored on CD-R/-RW, DVD-R/-RW/+R/+RW disc and SD Memory Card.

1 Press **POP UP MENU** while the file browser screen is displayed. A thumbnail screen will appear.

※ Pressing **POP UP MENU** while the thumbnail screen is displayed returns you to the file browser screen.

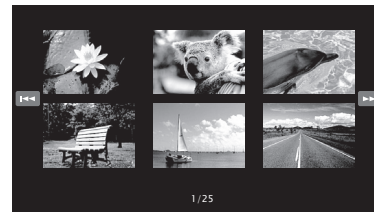

2 Use **▲ ▼ ◀ ▶** to select still images.

3 Press **ENTER**. Displays selected image on full screen.

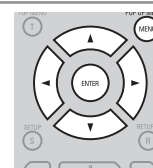

- Set the image display time on the GUI menu with: "Display Setup" – "Slide Show Time" (page 30).
- With a large image file, the image may display for longer than the set time.

Changing the Still Image being Played

- Press **◀ ▶**.
- Before playback or display of next image.

Pausing the Display

- Press **⏸**.
- To cancel pause, press **▶**.

Changing the Still Image Orientation

Press **◀ ▶**.

- ◀ ▶ 180° rotation
- ◀ Rotates 90° left
- ▶ Rotates 90° right



Returning to the Thumbnail Display Screen

Press **POP UP MENU**.

Operations Enabled During Playback

Operations Enabled During Playback

- Pausing (👉 page 41)
- Stopping (Resume Function) (👉 page 41)
- Skipping to a Desired Chapter/Track/File (👉 page 41)
- Finding Specific Sections with Search Modes (👉 page 42)
- Memorizing Locations to Replay (Marker Function) (👉 page 43)
- Fast-Forward/Fast-Reverse (👉 page 43)
- Playing Images Frame by Frame (👉 page 43)
- Slow Forward/Slow Reverse Playback (👉 page 43)
- Playback in Random Order (Random Playback) (👉 page 44)
- Playing Back Repeatedly (Repeat Playback) (👉 page 44)
- Repeat Playback between Specified Points (A-B Repeat) (👉 page 44)
- Playing Back in your Preferred Order (Program Playback) (👉 page 45)
- Switching Audio (👉 page 45, 46)
- Changing the Subtitles and Subtitle Style (👉 page 46)
- Switching the Angle (👉 page 47)
- Changing the Brightness of the Display (Dimmer Control) (👉 page 47)

Pausing



Press **[]** during playback.

The "II" indicator will light on the display.

※ Resume normal playback by pressing **[▶]**.



If the video is blurred while paused, stop playback and press **[S]**, then, on the GUI menu, change "Display Setup" – "Still Mode" – "Field" (👉 page 30).

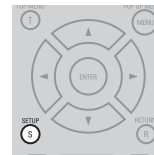

Stopping (Resume Function)



Press **[]** during playback.

Playback stops.

About the Resume Function



When playback is stopped, the stop position is memorized.

- The "▶" indicator flashes on the display. To resume play from the stop position, press **[▶]** while stopped.

To Cancel the Resume Function

Perform one of the following operations.

- Press **[]** while stopped.
- Open the disc tray.
- Change the playback media mode with **[SOURCE]**.
- Remove the SD Memory Card.



- The resume function does not work with menu playback or BD-J (Blu-ray Disc Java) compatible discs.
- The resume function remains valid even when the standby mode is set. With DivX® files, however, the resume function is cancelled even when the standby mode is set.
- The resume function is cancelled when the power is cut off by unplugging the power cord.

Skipping to a Desired Chapter/Track/File



During playback, press **[]** or **[]**.

- []** Playback begins from the start of the chapter/track/file being played.
- []** Playback begins from the start of the next chapter/track/file.

※ Continue pressing and skip to the chapter/track/file by the number of times pressed.



Skipping to the start of a title or group may be prohibited, depending on the disc.

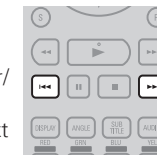

Operations Enabled During Playback

Finding Specific Sections with Search Modes



1 During playback, press **SEARCH** and then select the search mode.

The search mode setting bar is displayed at the top of the screen.

- The search mode changes each time the button is pressed.

Chapter search

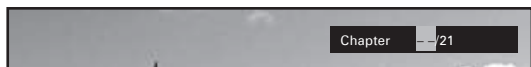

Title search



Track search



Group search



Time search



Marker search



[Search mode-compatible media and files]

Media / file	BD	DVD-A	SA-CD	DivX	MP3	WMA
	DVD-V		CD		LPCM	JPEG
	DVD				AAC	
Search mode						
Chapter search	<input type="radio"/>					
Title search	<input type="radio"/>					
Time search	<input type="radio"/>	<input type="radio"/>	<input type="radio"/>	<input type="radio"/>		
Marker search ※	<input type="radio"/>	<input type="radio"/>		<input type="radio"/>		
Track search		<input type="radio"/>	<input type="radio"/>	<input type="radio"/>	<input type="radio"/>	
Group search		<input type="radio"/>				

※ About Marker Search

Plays back from your selected marker number.



- When the entry mode for chapter/title/track/group search continues for about 5 seconds with no operation, it is cancelled.
- When the power is set to standby or the disc is removed, the set marker is deleted.

2 Enter search conditions or make settings on the search mode setting bar.

Once an entry is finalized, it searches for the specified location.

- 0 ~ 9, +10 Number entry
- ENTER Finalizes number
- ← → Marker number selection
- ENTER Finalizes the marker number or plays back
- CLEAR Cancels the marker number

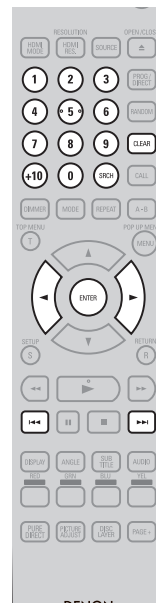

- Entering numbers
To enter 3 (3) ENTER *
- To enter 26 (2) (6) ENTER * or (+10) (+10) (6)
- To enter 138 (1) (3) (8) ENTER *

* : Depending on number of recorded songs or chapters, you may not need to use the “ENTER” button.

- The search modes do not operate during program or random playback. Use (◀), (▶) to cue.
- Time search works with title and track playback time. It is not does not work with chapter playback time.
- Search modes may not operate with some discs.

Memorizing Locations to Replay (Marker Function)

BD DVD-V DVD-A DVD SD DivX

You can attach a marker to a location you want to view or hear again, so that playback begins at that location.

1 During playback, press **SRCH**, and then select "Marker".

The search mode setting bar is displayed at the top of the screen.



2 Use **←** and **→** to select a number.



※ Numbers you have already set will be displayed as "✓".

3 Press **ENTER** at the location you want to memorize.

The location is registered for the selected marker number.

※ The elapsed playing time at the set location is displayed.

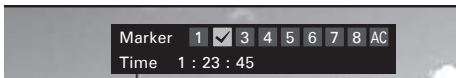

To Play Back Memorized Locations

Use **←** and **→** to select the marker number, then press **ENTER**.



To erase markers

Select the number you want to erase, and then press **CLEAR**.

To erase all markers

Select "AC" and press **ENTER**.



- Subtitles may not appear depending on the locations you have memorized.
- The markers you have set will be erased if you turn the power to standby or eject the disc.
- The marker function does not operate across titles and groups.
- Marker search can only be performed during playback.

Fast-Forward/Fast-Reverse

BD DVD-A DVD-V DVD SA-CD CD SD

MP3 WMA AAC LPCM DivX

During playback, press **FF** or **FR**.

- The fast-forward/fast-reverse speed changes each time the button is pressed.
- The speed varies with the disc and file.

※ Resume normal playback by pressing **▶**.

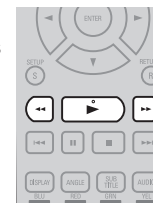

- You cannot fast-forward/fast-reverse across files or tracks during program or random playback.
- Fast-forward/fast-reverse may be disabled with some DivX® files.
- Audio is not output during fast-forward/fast-reverse of a BD or DVD.

Playing Images Frame by Frame

BD DVD-V DivX

Press **⏮** while paused.

The disc advances frame by frame each time the button is pressed.

※ Resume normal playback by pressing **▶**.



- Frame by frame reverse playback is not available with the DBP-A100.
- If the video is shaky during frame by frame playback, stop playback, press **SETUP**, then on the GUI menu, change "Display Setup" – "Still Mode" – "Field" (ⓘ page 30).



Slow-Forward/Slow-Reverse Playback

BD DVD-V DVD

Press **⏪** or **⏩** while paused.

The speed changes each time the button is pressed.

※ The speed of slow-reverse playback does not change.

※ Resume normal playback by pressing **▶**.



- Audio is not output during slow-forward/slow-reverse playback.
- If the video is blurred during slow-forward/slow-reverse playback, stop playback and press **SETUP**, then on the GUI menu, change "Display Setup" – "Still Mode" – "Field" (ⓘ page 30).

Operations Enabled During Playback

Playing in Random Order (Random Playback)

SA-CD CD SD MP3 WMA AAC LPCM DivX

1 Press **RANDOM** while stopped.
The "RAND" lights on the display and "Random Mode" is displayed on the screen.

2 Press **▶** to play.

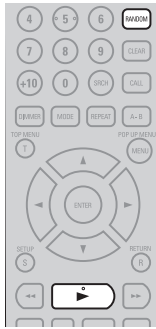

Resuming Normal Playback

Press **RANDOM** while stopped.



Random playback may not be available with some discs.

Playing Repeatedly (Repeat Playback)

BD DVD-A DVD-V DVD SA-CD CD SD
MP3 WMA AAC LPCM DivX JPEG

1 Press **REPEAT** during playback.
The repeat mode icon is displayed at the top of the screen.
• The repeat mode changes each time the button is pressed.

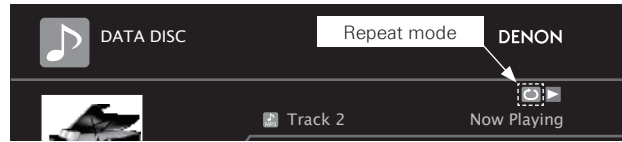

2 Press **REPEAT** to select the repeat mode.

※ To resume normal playback, press **REPEAT**, and select "Repeat Off".

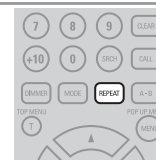

Playing Repeatedly Between Specified Points (A-B Repeat)

BD DVD-A DVD-V DVD SA-CD CD SD DivX

1 During playback, press **A-B** at the desired starting point (A).
The "A-" indicator will light on the display.

※ To cancel the starting point (A), press **CLEAR**.

2 Press **A-B** again at the desired ending point (B).
The "B" indicator will light on the display, and A-B repeat playback will start.

※ To resume normal playback, press **A-B**, and select "Repeat Off".



- You cannot skip a title/file with A-B repeat.
- If you perform a search operation during A-B repeat playback, A-B repeat playback is cancelled.
- A-B repeat playback may not be available with some scenes.
- A-B repeat playback of MP3/WMA/AAC/JPEG/LPCM files is not available.
- A-B repeat playback is not available during repeat playback.
- A-B repeat playback may not be available with some DivX® files.

About Repeat Modes

The available repeat modes vary depending on the disc or file you are playing.

Media/File	BD	DVD-A	SA-CD	MP3	Display
	DVD-V		CD	WMA	
Mode	DVD			AAC	
				LPCM	
				DivX	
				JPEG	
Chapter repeat	○				↺
Track repeat		○	○	○	↺
Title repeat	○				
Group repeat		○			↺
All repeat			○	○	



- Some repeat modes may not be accessible depending on some discs. With some discs, even when set to repeat playback, the disc may not return to the start of title or chapter, and may advance to the next scene.
- Repeat playback is not available during A-B repeat playback.

Playing in Your Preferred Order (Program Playback)

SA-CD CD

You can program up to a maximum of 20 tracks.

1 Press **PROG/DIRECT** while stopped during stop.

The "PROG" indicator lights on the display, and the program setting screen appears.

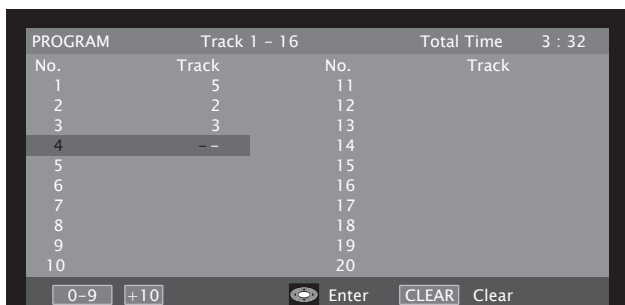

2 Enter the track numbers you want to program on the program setting screen.

0 ~ 9, +10 Entry
 ENTER Set entry

3 Press **▶**.

Playback begins in the programmed order.

❑ Checking the Program Contents

Press **CALL** during playback.
 The program setting screen will appear.



You can also check the contents of the program on the unit's display. Press **CALL** while stopped.

❑ Erasing Programmed Tracks One by One

Press **CLEAR** during stop.

❑ Erasing All Programming

Press **PROG/DIRECT**.

Switching Audio

BD DVD-A DVD-V DVD CD SD DivX

With discs and files that have multiple audio track recording, you can change the audio during playback.

With BD, you can set playback to sub-track audio, such as interactive audio and commentary audio, etc., with "Secondary".

Switching a BD's Primary Audio/Secondary Audio

1 During playback of Primary Audio/Secondary Audio title, press **AUDIO**.

The audio number currently being played is displayed.

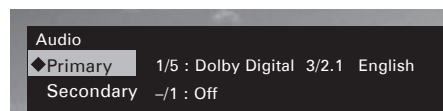

2 Press **▲** or **▼**, select "Primary" or "Secondary", and then press **ENTER**.

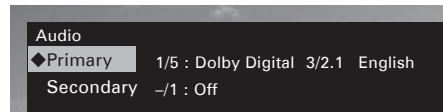

※ If multiple audio items are recorded, "the current audio number/number of recorded audio items" is displayed.

※ When "BD Audio Mode" is set to "HD Audio Output" (page 32), "Secondary" audio is not output.

3 Select your desired audio language with **▲** or **▼**.

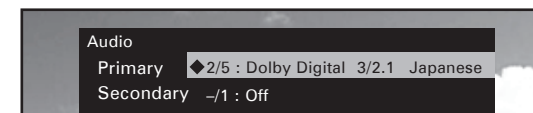

4 Press **AUDIO**.

The setup screen disappears.



- Depending on the disc, audio switching may be restricted to operation of the disc menu. In this case, switch the audio on the disc menu.
- Be sure to set "BD Audio Mode" to "Mix Audio Output" (page 32) for playing back secondary audio.
- Depending on the BD, even if picture-in-picture playback is set to "Off", Secondary Audio only may be output.

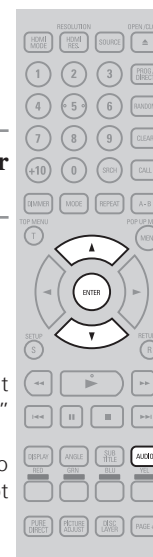

Operations Enabled During Playback

Audio Switching (Media Other than BD)

1 Press **AUDIO** during playback.
The audio number currently being played is displayed.

[Example] DVD

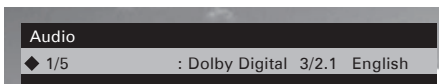

2 Use **▲** **▼** to select audio

[Example] DVD-Video

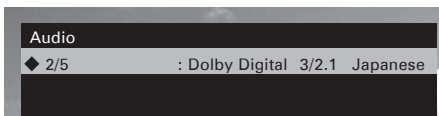

3 Press **AUDIO**.
The setup screen disappears.



- With DVD-R/-RW with bilingual soundtrack recording, you can switch between “Main” (main audio) and “Sub” (secondary audio) or “Main/Sub” (main audio + secondary audio).
- In CD audio mode, you can switch to “Stereo”, “L-ch” (left channel) or “R-ch” (right channel).
- With a DivX® file, “MP3” or “Dolby Digital” audio formats and the number of recorded audio modes are displayed. “-- --” appears for audio other than these.
- With DTS-CD (5.1 music disc), you cannot switch audio modes.

Changing the Subtitles and Subtitle Style

BD DVD-V SD DivX

During playback of a disc or file with recorded subtitles, you can switch the subtitles on/off as well as the subtitle language. With BD, you can change the style of displayed subtitles.

Switching a BD’s Primary Subtitle/Secondary Subtitle and Subtitle Style

1 Press **SUB TITLE** during playback.
The subtitle number currently being played is displayed.

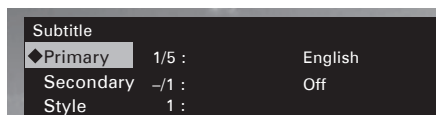

2 With **▲** **▼**, select “Primary”, “Secondary” and “Style”, and then press **ENTER**.

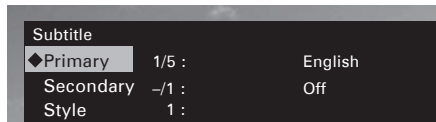

3 Use **▲** **▼** to select your desired subtitle language and subtitle style.

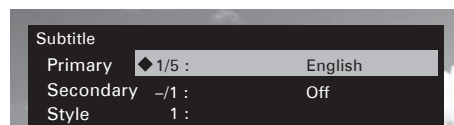

4 Press **SUB TITLE**.
The setup screen disappears.



- If a disc does not include subtitles and/or subtitle style, “Not Available” is displayed.
- Depending on the disc, subtitle switching may be restricted to operation of the disc menu. In this case, switch the subtitles on the disc menu.

Selecting DVD-Video and DivX® File Subtitles

1 Press **SUB TITLE** during playback.
The subtitle number currently being played is displayed.

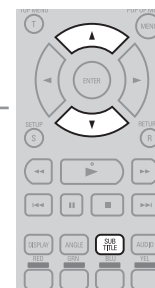
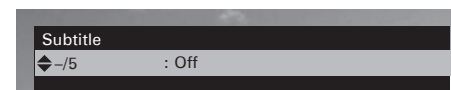

2 Use **▲** **▼** to select subtitles.

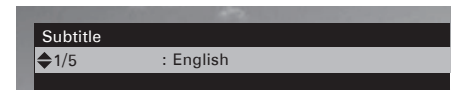

With a DivX® file, the currently playing subtitle number and number of recorded subtitles are displayed; the language option is not displayed.

Getting Started

Connections

Setup

Playback

HDMI Control Function

Information

Troubleshooting

Specifications

Operations Enabled During Playback

Switching the Angle

BD DVD-V

During playback of a BD or DVD-Video recorded with several camera angles, you can change the angle.

1 Press **ANGLE** during playback.

The angle number currently being played is displayed.

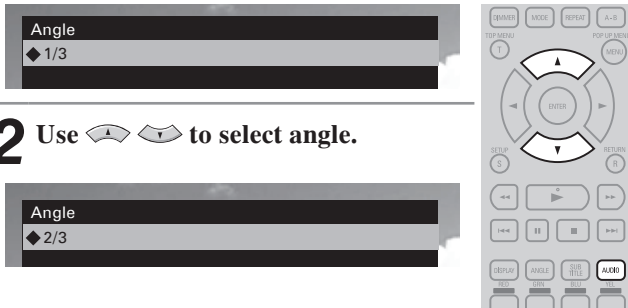
3 Press **ANGLE**.

The setup screen disappears.

NOTE

Angle changing may be restricted, depending on the disc.

Changing the Brightness of the Display (Dimmer Control)

Press **DIMMER**.

The brightness changes each time the button is pressed.



→ Normal → Dim → Dark → Off →



Even when "Off" is selected, the status of operations that are performed appears momentarily on the display if "Display Setup" – "Temporary Display" on the GUI menu is set to "On" (page 30).

Web control function

DBP-A100 has "Web control function" support that allows you to operate DBP-A100 via LAN from your PC, PDA, iPod® touch, and iPhone®.

Operating DBP-A100 using a PC browser

- Connect DBP-A100 to the network. ("Connecting to the Network" (page 19).
- Please use the Internet Explorer or FireFox browser.

Preparation

Press **SETUP** on the remote control to display the GUI menu.

1 Check the IP address of DBP-A100. (page 30)

- Select "Network Setup" from the GUI menu and then select "IP Address".
- The address displayed for "Control" is the IP address of DBP-A100.

2 Enter the DBP-A100 IP address in browser's address box.

- For example, if the IP address of DBP-A100 is "192.168.11.217", enter <http://192.168.11.217>.
- The top menu appears on the PC screen.

NOTE

If you set "DHCP" in "Network Setup" of the GUI menu to "On", the IP address of DBP-A100 will change every time DBP-A100 is connected. Check the IP address, whenever you use the Web control function. (page 30)



3 Click the menu you want to operate.

- | | |
|-----------------------|---|
| Player Control | Click to operate DBP-A100. |
| Setup Menu | Click to operate the Setup Menu. |
| PDA Menu | Click to operate DBP-A100 using a PDA terminal. |

Player Control

You can perform basic operations of DBP-A100 from a PC screen using the "Player Control" menu. Each operation button on this screen functions in the same way as the buttons on DBP-A100 and remote control.



- ① Shortcut key to each menu.
- ② Click when you update to the latest information.
- ③ Click to add a setting to "Favorites".
- ④ To turn on power using the ON button of a PC browser, set "Power Saving" in "Other Setup" of the GUI menu to "Quick Start Mode". (page 31)

Web control function

Setup Menu

You can perform various settings of DBP-A100 on the Setup Menu screen.

For further information about setting items, see "GUI Menu Setup" on page 21.



- ① Click the menu from which you want to make settings.
- The display on the right becomes each setting screen.
- ② "SAVE": Click to save settings. The settings are saved on your PC.
"LOAD": Click to recall settings.
- ③ Click the setting item.
- ④ Click "▼" and select from the displayed items.
- ⑤ Enter values or click "<" or ">" to make the setting.
Click "Set" to set the values.
- ⑥ Click to return to the top menu.

PDA Menu

You can perform basic operations of DBP-A100 from a PDA using the PDA Menu screen.

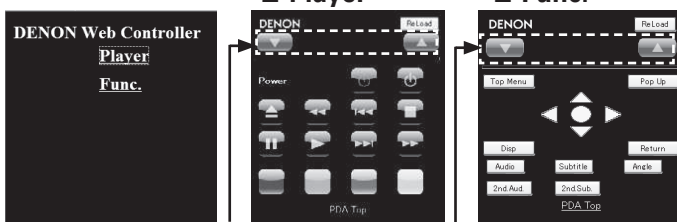

Buttons for switching the displayed screens

Buttons for switching the displayed screens

Operating DBP-A100 using the iPod browser

- You can perform basic operations of DBP-A100 using network-ready iPod products such as iPhone® and iPod® touch.
- Before starting the operation, connect DBP-A100 to the network. ("Connecting to the Network" page 19).

iPhone® and iPod® touch is a trademark or registered trademark of Apple Inc. in the U.S. and other countries.

Preparation

Press on the remote control to display the GUI menu.

1 Check the IP address of DBP-A100. (page 30)

Select "Network Setup" from the GUI menu and then select "IP Address".

The address displayed for "Control" is the IP address of DBP-A100.

2 Enter the DBP-A100 IP address in browser's address box.

- For example, if the IP address of DBP-A100 is "192.168.11.217", enter http://192.168.11.217.
- The top menu appears on the PC screen.

NOTE

If you set "DHCP" in "Network Setup" of the GUI menu to "On", the IP address of DBP-A100 will change every time DBP-A100 is connected. Check the IP address, whenever you use the Web control function. (page 30)



- PLAYER** Click to display the screen used for basic playback operation.
- OPTION** Click to operate random or repeat playback and perform output signal-related settings.
- MODE** Click to perform advanced settings.



- For details on setting items, see the Owner's Manual.
- To switch to another mode while the operation screen of each mode is being displayed, use the iPod browser's back button "◀" to return to the top menu.

Operation the iPod menu screen

- PLAYER**
- OPTION**
- MODE**

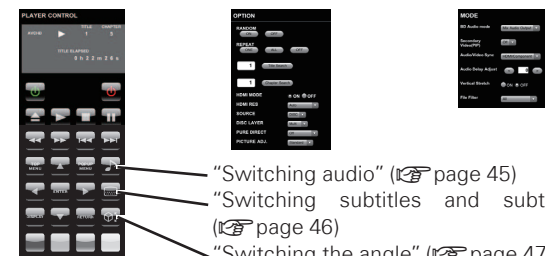

- "Switching audio" (page 45)
- "Switching subtitles and subtitle style" (page 46)
- "Switching the angle" (page 47)

HDMI Control Functions

When you make HDMI connections with a TV or AV Amp compatible with DBP-A100 and HDMI control functions, you can perform the following operations by setting up the HDMI control functions of each device.

- ❑ **TV or AV Amp power is turned on by operating the DBP-A100 and functions change with DBP-A100 input.**
- ❑ **Turning off the TV's power turns the DBP-A100's power to standby.**
- ❑ **Operating the DBP-A100 via the TV's remote control.**
(When the TV's remote control has player operation buttons)

NOTE

- The HDMI control function controls operations of a TV that is compatible with the HDMI control function. Make sure that the TV and HDMI are connected when you perform HDMI control.
- Some functions may not operate depending on the connected TV or AV Amp. Check the owner's manual of each device for details beforehand.
- When "Other Setup" – "Power Saving" on the GUI menu is set to "Power Saving Standby" or "Normal Standby" (🔧 page 31), the player's power cannot be turned on using the HDMI control function.
- When "HDMI Setup" – "HDMI Control" – "Power Off Control" on the GUI menu is set to "Off" (🔧 page 24), the DBP-A100 does not go to standby even if the connected device is in the standby mode.
- When "DENON LINK Setup" – "DENON LINK Mode" on the GUI menu is set to "4th", the HDMI control function is enabled for the connected devices.

1 Set the HDMI control function to "On".

On the GUI menu, set "HDMI Setup" – "HDMI Control" (🔧 page 24).

2 Turn on all the equipment connected by HDMI cable.

3 Set the HDMI control function for all equipment connected by HDMI cable.

On the GUI menu, set the DBP-A100 with "HDMI Setup" – "HDMI Control" (🔧 page 24).

※ Please refer to the owner's manuals of connected devices for how to make settings.

※ Carry out Steps 2 and 3 if any of the equipment was unplugged.

4 To ensure that the DBP-A100's HDMI video output is projected on the TV screen, change the input function of the TV and AV Amp.

5 When you turn the TV's power to standby, check that the power of the DBP-A100 and AV Amp also goes on standby.



If the HDMI control function does not operate properly, check the following points.

- Is the TV or AV Amp compatible with the HDMI control function?
- Are the HDMI control function settings of all equipment correct? (Step 3)
- After setting, did you add another HDMI device connection or make any changes in the connections? If so make the settings again.

Other Information

About DENON LINK

DENON LINK is a unique digital, balanced transfer type of interface developed by DENON. It offers high-speed, high-quality transfer of digital audio data with low signal loss. It can be used with DENON AV Amp equipped with a special DENON LINK connector via a single cable to enable playback with high sound quality. It allows digital transfer of the 192 kHz/24 bit 2-channel digital signals of DVD-Audio discs, PCM multi-channel signals, etc. Full-spec digital transfer of the audio contents of Super Audio CD is possible by connecting a player equipped for DENON LINK 3rd Generation. During processing of DENON LINK, the DENON LINK indicator of the display lights. DENON LINK 4th uses the clock of the AV Amp connected by DENON LINK to achieve HDMI signal transfer with little jitter when playing BD.

About Advanced AL24 Processing



“Advanced AL24 Processing” installed in the analog output dramatically improves the information volume on the time axis with independent speed signal detection and processing technology for the PCM signal playback system. In addition to data expansion to 24 bit, it conducts natural interpolation processing with no loss of original data by digital upsampling. The “Advanced AL24” indicator lights on the front panel when Advanced AL24 Processing is in operation.





About Copyright Protection Technology

This item incorporates copy protection technology that is protected by U.S. patents and other intellectual property rights of Rovi Corporation. Reverse engineering and disassembly are prohibited.

Trademark Information

This product uses the following technologies:

	“Blu-ray Disc” and “  ” are trademarks.
	DVD is a trademark of the DVD Format / Logo licensing Corporation.
	HDMI, the HDMI Logo and High-Definition Multimedia Interface are trademarks or registered trademarks of HDMI Licensing LLC in the United States and other countries.
	Java and all other trademarks and logos are trademarks or registered trademarks of Sun Microsystems, Inc. in the United States and/or other countries.
	Manufactured under license from Dolby Laboratories. “Dolby”, “Pro Logic” and the double-D symbol are trademarks of Dolby Laboratories.
	Manufactured under license under U.S. Patent #'s: 5,451,942; 5,956,674; 5,974,380; 5,978,762; 6,226,616; 6,487,535; 7,392,195; 7,272,567; 7,333,929; 7,212,872 & other U.S. and worldwide patents issued & pending. DTS and the Symbol are registered trademarks, & DTS-HD, DTS-HD Master Audio Essential and the DTS logos are trademarks of DTS, Inc. Product includes software. © DTS, Inc. All Rights Reserved.
	Windows Media and the Windows logo are trademarks or registered trademarks of Microsoft Corporation in the United States and/or other countries.
	DivX®, DivX Certified®, and associated logos are registered trademarks of DivX, Inc. and are used under license.

	HDCD ®, HDCD®, High Definition Compatible Digital® and Microsoft® are either registered trademarks or trademarks of Microsoft Corporation, Inc. in the United States and/or other countries. HDCD system manufactured under license from Microsoft Corporation, Inc. This product is covered by one or more of the following: In the USA: 5,479,168, 5,638,074, 5,640,161, 5,808,574, 5,838,274, 5,854,600, 5,864,311, 5,872,531, and in Australia: 669114. Other patents pending.
	“AVCHD” and the “AVCHD” logo are trademarks of Panasonic Corporation and Sony Corporation.
	“BONUSVIEW” is the trademark of Blu-ray Disc Association.
	The “BD-LIVE” logo is a trademark of Blu-ray Disc Association.
	The SDHC-logo is trademarkedk.

Language Code List

Language	Code
A Abkhazian	4748
Afar	4747
Afrikaans	4752
Albanian	6563
Amharic	4759
Arabic	4764
Armenian	5471
Assamese	4765
Aymara	4771
Azerbaijani	4772
B Bashkir	4847
Basque	5167
Bengali; Bangla	4860
Bhutani	5072
Bihari	4854
Bislama	4855
Breton	4864
Bulgarian	4853
Burmese	5971
Belarusian	4851
C Cambodian	5759
Catalan	4947
Chinese	7254
Corsican	4961
Croatian	5464
Czech	4965
D Danish	5047
Dutch	6058
E English	5160
Esperanto	5161
Estonian	5166
F Faroese	5261
Fiji	5256
Finnish	5255
French	5264
Frisian	5271
G Galician	5358
Georgian	5747
German	5051
Greek	5158
Greenlandic	5758
Guarani	5360
Gujarati	5367
H Hausa	5447
Hebrew	5569
Hindi	5455
Hungarian	5467

Language	Code
I Icelandic	5565
Indonesian	5560
Interlingua	5547
Interlingue	5551
Inupiak	5557
Irish	5347
Italian	5566
J Japanese	5647
Javanese	5669
K Kannada	5760
Kashmiri	5765
Kazakh	5757
Kinyarwanda	6469
Kirghiz	5771
Kirundi	6460
Korean	5761
Kurdish	5767
L Laothian	5861
Latin	5847
Latvian; Lettish	5868
Lingala	5860
Lithuanian	5866
M Macedonian	5957
Malagasy	5953
Malay	5965
Malayalam	5958
Maltese	5966
Maori	5955
Marathi	5964
Moldavian	5961
Mongolian	5960
N Nauru	6047
Nepali	6051
Norwegian	6061
O Occitan	6149
Oriya	6164
Oromo (Afan)	6159
P Punjabi	6247
Pashto; Pushto	6265
Persian	5247
Polish	6258
Portuguese	6266
Q Quechua	6367
R Rhaeto-Romance	6459
Romanian	6461
Russian	6467

Language	Code
S Samoan	6559
Sangho	6553
Sanskrit	6547
Scots Gaelic	5350
Serbian	6564
Serbo-Croatian	6554
Sesotho	6566
Setswana	6660
Shona	6560
Sindhi	6550
Singhalese	6555
Siswat	6565
Slovak	6557
Slovenian	6558
Somali	6561
Spanish	5165
Sundanese	6567
Swahili	6569
Swedish	6568
T Tagalog	6658
Tajik	6653
Tamil	6647
Tatar	6666
Telugu	6651
Thai	6654
Tibetan	4861
Tigrinya	6655
Tonga	6661
Tsonga	6665
Turkish	6664
Turkmen	6657
Twi	6669
U Ukrainian	6757
Urdu	6764
Uzbek	6772
V Vietnamese	6855
Volapuk	6861
W Welsh	4971
Wolof	6961
X Xhosa	7054
Y Yiddish	5655
Yoruba	7161
Z Zulu	7267

Country Code List

Country	Code	Country	Code	Country	Code	Country	Code	Country	Code
A AFGHANISTAN	AF	CUBA	CU	JORDAN	JO	NORFOLK ISLAND	NF	T TAJIKISTAN	TJ
ÅLAND ISLANDS	AX	CYPRUS	CY	K KAZAKHSTAN	KZ	NORTHERN MARIANA ISLANDS	MP	TANZANIA, UNITED REPUBLIC OF	TZ
ALBANIA	AL	CZECH REPUBLIC	CZ	KENYA	KE	OMAN	OM	TIMOR-LESTE	TL
ALGERIA	DZ	D DJIBOUTI	DJ	KIRIBATI	KI	P PALAU	PW	TOGO	TG
AMERICAN SAMOA	AS	DOMINICA	DM	KOREA, DEMOCRATIC PEOPLE'S REPUBLIC OF	KP	PALESTINIAN TERRITORY, OCCUPIED	PS	TOKELAU	TK
ANDORRA	AD	DOMINICAN REPUBLIC	DO	KUWAIT	KW	PANAMA	PA	TONGA	TO
ANGOLA	AO	E ECUADOR	EC	KYRGYZSTAN	KG	PAPUA NEW GUINEA	PG	TRINIDAD AND TOBAGO	TT
ANGUILLA	AI	EGYPT	EG	L LAO PEOPLE'S DEMOCRATIC REPUBLIC	LA	PARAGUAY	PY	TUNISIA	TN
ANTARCTICA	AQ	EL SALVADOR	SV	LATVIA	LV	PERU	PE	TURKEY	TR
ANTIGUA AND BARBUDA	AG	EQUATORIAL GUINEA	GQ	LEBANON	LB	PITCAIRN	PN	TURKMENISTAN	TM
ARMENIA	AM	ERITREA	ER	LESOTHO	LS	PUERTO RICO	PR	TURKS AND CAICOS ISLANDS	TC
ARUBA	AW	ESTONIA	EE	LIBERIA	LR	Q QATAR	QA	TUVALU	TV
AZERBAIJAN	AZ	ETHIOPIA	ET	LIBYAN ARAB JAMAHIRIYA	LY	RÉUNION	RE	UGANDA	UG
B BAHAMAS	BS	F FALKLAND ISLANDS (MALVINAS)	FK	LIECHTENSTEIN	LI	ROMANIA	RO	UKRAINE	UA
BAHRAIN	BH	FAROE ISLANDS	FO	LITHUANIA	LT	RWANDA	RW	UNITED ARAB EMIRATES	AE
BANGLADESH	BD	FIJI	FJ	M MACAO	MO	SAINT BARTHÉLEMY	BL	UNITED STATES MINOR OUTLYING ISLANDS	UM
BARBADOS	BB	FRENCH GUIANA	GF	MACEDONIA, THE FORMER YUGOSLAV REPUBLIC OF	MK	SAINT HELENA	SH	URUGUAY	UY
BELARUS	BY	FRENCH POLYNESIA	PF	MADAGASCAR	MG	SAINT KITTS AND NEVIS	KN	UZBEKISTAN	UZ
BELIZE	BZ	FRENCH SOUTHERN TERRITORIES	TF	MALAWI	MW	SAINT LUCIA	LC	V VANUATU	VU
BENIN	BJ	G GABON	GA	MALDIVES	MV	SAINT MARTIN	MF	VATICAN CITY STATE	VA
BERMUDA	BM	GAMBIA	GM	MALI	ML	SAINT PIERRE AND MIQUELON	PM	VENEZUELA	VE
BHUTAN	BT	GEORGIA	GE	MALTA	MT	SAINT VINCENT AND THE GRENADINES	VC	VIET NAM	VN
BOLIVIA	BO	GHANA	GH	MARSHALL ISLANDS	MH	SAMOA	WS	VIRGIN ISLANDS, BRITISH	VG
BOSNIA AND HERZEGOVINA	BA	GIBRALTAR	GI	MARTINIQUE	MQ	SAN MARINO	SM	VIRGIN ISLANDS, U.S.	VI
BOTSWANA	BW	GREENLAND	GL	MAURITANIA	MR	SAO TOME AND PRINCIPE	ST	W WALLIS AND FUTUNA	WF
BOUVET ISLAND	BV	GRENADA	GD	MAURITIUS	MU	SAUDI ARABIA	SA	WESTERN SAHARA	EH
BRITISH INDIAN OCEAN TERRITORY	IO	GUADELOUPE	GP	MAYOTTE	YT	SENEGAL	SN	Y YEMEN	YE
BRUNEI DARUSSALAM	BN	GUAM	GU	MICRONESIA, FEDERATED STATES OF	FM	SERBIA	RS	Z ZAMBIA	ZM
BULGARIA	BG	GUATEMALA	GT	MOLDOVA	MD	SEYCHELLES	SC	ZIMBABWE	ZW
BURKINA FASO	BF	GUERNSEY	GG	MONACO	MC	SIERRA LEONE	SL		
BURUNDI	BI	GUINEA	GN	MONGOLIA	MN	SLOVAKIA	SK		
C CAMBODIA	KH	GUINEA-BISSAU	GW	MONTENEGRO	ME	SLOVENIA	SI		
CAMEROON	CM	GUYANA	GY	MONTSERRAT	MS	SOLOMON ISLANDS	SB		
CAPE VERDE	CV	H HAITI	HT	MOROCCO	MA	SOMALIA	SO		
CAYMAN ISLANDS	KY	HEARD ISLAND AND MCDONALD ISLANDS	HM	MOZAMBIQUE	MZ	SOUTH AFRICA	ZA		
CENTRAL AFRICAN REPUBLIC	CF	HOLY SEE (VATICAN CITY STATE)	VA	MYANMAR	MM	SOUTH GEORGIA AND THE SOUTH SANDWICH ISLANDS	GS		
CHAD	TD	HONDURAS	HN	N NAMIBIA	NA	SRI LANKA	LK		
CHRISTMAS ISLAND	CX	HUNGARY	HU	NAURU	NR	SUDAN	SD		
COCOS (KEELING) ISLANDS	CC	I ICELAND	IS	NEPAL	NP	SURINAME	SR		
COMOROS	KM	IRAN, ISLAMIC REPUBLIC OF	IR	NETHERLANDS ANTILLES	AN	SVALBARD AND JAN MAYEN	SJ		
CONGO	CG	IRAQ	IQ	NEW CALEDONIA	NC	SWAZILAND	SZ		
CONGO, THE DEMOCRATIC REPUBLIC OF THE	CD	ISLE OF MAN	IM	NICARAGUA	NI	SYRIAN ARAB REPUBLIC	SY		
COOK ISLANDS	CK	ISRAEL	IL	NIGER	NE				
COSTA RICA	CR	J JAMAICA	JM	NIGERIA	NG				
CÔTE D'IVOIRE	CI	JERSEY	JE	NIUE	NU				
CROATIA	HR								

Explanation of Terms

Numerics

4:3 letterbox

When a wide (16:9) disc is played on the DBP-A100 while connected to a 4:3 TV, this function displays the image with a black area at the top and bottom.

4:3 pan-and-scan

When a wide (16 : 9) disc is played on the DBP-A100 while connected to a 4:3 TV, this function cuts the left and right of the displayed image to the 4 : 3 size according to the disc's control information.

A

Anamorphic lens

This lens enlarges the 16:9 image to a 2.35:1 image when projecting the image with a projector.

Aspect ratio

This is the length and width ratio of the TV screen. The conventional TV screen's ratio is 4:3 and a wide screen TV's screen ratio is 16:9.

B

BD-J (Java)

BD-Videos offer fun software with more interactive functions (games) that use Java applications.

BD-LIVE

The DBP-A100 can be connected to the Internet to enjoy a number of features, including additional contents such as special videos or subtitles, network games, etc.

Bit rate

This is the amount of video or audio data recorded on a disc that is read in one second.

Blu-ray disc

This is a one-sided, one-layer disc with 25GB capacity for recording high vision video movie and games.

Bonus View

Special images for BD-Videos. It includes comments from the movie director, simultaneously developing sub-stories, and images from different angles.

C

Chapter

This is a break intended by the producer, who organizes the titles of BD or DVD-Videos. The chapter search function searches for the beginning of this break.

D

Deep Color

This technology allows expression of more colors than the conventional 8-bit and can reproduce more natural colors without any color streaking.

DHCP (Dynamic Host Configuration Protocol)

This mechanism automatically performs network configurations, such as IP addressing for network devices, including DBP-A100, PCs, and broadband routers.

Dolby Digital (5.1-ch Surround)

This is a stereophonic effect developed by Dolby Laboratories. This is a maximum of 5.1 channels, independent multi-channel audio system.

Dolby Digital Plus

This is an extended version of Dolby Digital and is a high sound quality, digital audio technology adopted as an optional audio for Blu-ray discs.

Dolby TrueHD

This lossless coding technology is adopted as an optional audio for Blu-ray disc and supports 7.1 channels.

Downmix

This function converts the number of channels of surround audio to less channels for playback.

DTS

This is an abbreviation of Digital Theater System, which is a digital audio system developed by DTS. When playing audio on this system while connected to a device such as a DTS amplifier, accurate sound field position and realistic sound effects can be obtained, making you feel like you are in a movie theater.

DTS-HD

This audio technology provides an enhanced functionality and a higher quality of sound than conventional DTS and is adopted as an optional audio for Blu-ray disc. This technology supports multi-channel, high data transfer speed, high sampling-frequency, and lossless audio playback. A maximum of 7.1 channels are supported on Blu-ray discs.

Dynamic range

The difference between the maximum, undistorted sound level and the minimum sound level that is discernible above the noise emitted by the device.

F

Finalizing

This process enables BD/DVD/CD discs recorded with a recorder to be played by other players.

H

HDCP

When transmitting digital signals between devices, this copyright protection technology encrypts the signals to prevent content from being copied without authorization.

HDMI

This is an abbreviation of High-Definition Multimedia Interface, which is an AV digital interface that can be connected to a TV or amplifier. Video signal and audio signal can be connected with 1 cable.

I

Interlacing (interlaced scanning)

This conventional method used to project images on a TV displays 1 frame of image in half and half, respectively as 2 fields.

Interactive audio

This is audio recorded in the titles of BD-Videos, such as clicking sounds made during operations.

L

LFE

This is an abbreviation of Low Frequency Effect, which is an output channel that emphasizes low-frequency effect sounds. Surround audio is intensified by outputting 20Hz to 120Hz deep bass.

Linear PCM

This is an uncompressed PCM (Pulse Code Modulation) signal. This is the same system as the CD audio but uses 192kHz, 96kHz, and 48kHz sampling frequencies on BD or DVD and provides higher sound quality than CDs.

M

MPEG

This is an abbreviation of Moving Picture Experts Group, which is an international standard of the moving picture audio compression method. Images on BDs and DVDs are recorded using this method.

P

Picture-in-picture

This BD-Video function allows you to view scenes, such as the making of or commentary on the movie, in the secondary video while viewing the main story in the primary video.

Popup menu

This type of menu is recorded with BD software. While playing back a BD, this menu can be displayed on the front of the screen and can be operated.

Primary audio

This audio signal is recorded in the main story in BD-Video.

Progressive (sequential scanning)

This is a system for scanning the video signal that displays 1 frame of video as one image. Compared to the interlace system, this system provides images with less flickering and bleeding.

R

Rating

Depending on the age of the viewer, this function restricts the playing of BD-Videos or DVD-Videos. DBP-A100 can be set to restrict viewing in 0 to 254 levels for BD-Videos, and 1 to 8 levels for DVD-Videos.

Region code

This code indicates the country or region where the BD or DVD-Video can be played back.

S

Secondary audio

This is audio content, such as the director's comments, and other data recorded in the bonus view of BD-Video.

T

Title

This is the unit of content that consists of chapters of BD or DVD -Videos. Some BDs or DVD-Videos may include multiple titles.

Index

A	page	F	page	P	page
Adjusting the Picture Quality	33	File	4, 5	Pan Scan	24, 53
Advanced AL24 Processing	48	File Browser Screen	39	Picture-in-Picture	36, 53
Analog 7.1ch Connection	16	Finalizing	4, 53	Playback(BD)	36
Analog Audio Connection	18	Firmware Update	31	Playback(CD)	37
Audio Format	14, 16	Folder	5	Playback(DVD)	36
Audio Mode	32			Playback(DVD-Audio)	37
Audio Setup	25	G	page	Playback(JPEG)	39
Auto Power Mode	31	Group	5	Playback(Super Audio CD)	37
				Power Saving	31
B	page	H	page	Primary Audio	53
BD	3, 53	HDCP	15, 53	Progressive	24, 53
BD-Video	3, 5	HD Layer	5	Pure Direct	28, 38
BD-LIVE	36, 53	HDMI	12, 13, 53		
Bonus View	36, 53	HDMI Connection	13	R	page
Brightness of the Display	47	HDMI Control Function	47	Rating	29, 53
		HDMI Setup	23	Region Code	3, 53
C	page	Home Theater Playback	11	Remote Control Setting	31
Cables Used for Connections	12			Remote Control	7
CD	3, 5	I	page	Repeat Mode	44
CD-R/-RW	3, 5	Information Bar Display	34	Resume Function	41
Channel Level	23, 25	Interlacing	51		
Chapter	5, 51			S	page
Component Resolution	24	J	page	Screen Saver	30
Component Video Output	18	Jitter-free Connection	17	SD Memory Card	4, 5
Country Code	52	JPEG	4	Search Mode	42
				Secondary Audio	53
D	page	L	page	Setting HDMI Audio Output	14
Deep Color	23, 53	Language Code	51	Setting HDMI Video Output	13
DENON LINK	17, 28, 50	Language Setup	23	Source Direct	27
Digital Audio Connection	19	Letter Box	24, 53	Speaker Configuration	23, 25
Digital Audio Output	27	LFE	26, 53	Subtitle	46
DivX®	4, 5	Linear PCM(LPCM)	14, 16, 53	Super Audio CD	3, 5
Dolby Digital	14, 16, 51	LPCM	14, 16, 53		
Dolby Digital Plus	14, 16, 51			T	page
Dolby TrueHD	14, 16, 51	M	page	Time Display	35
Downmix	27, 51	Maintenance Mode	31	Title	5, 53
DTS	14, 16, 51	Marker Function	43	Track	5
DTS-HD	14, 16, 51	Menu Map	21	TV Aspect	24, 53
DVD-Audio	3, 5	MP3	4, 14, 16		
DVD-R/-RW/+R/+RW	3, 5	Multi linear PCM	14	V	page
DVD-Video	3, 5			Vertical Stretch	32
DVI-D Terminal	13	N	page	Video Setup	24
Dynamic Range	27, 51	Network	19, 29		
				W	page
				Web control	47
				WMA	4

Troubleshooting

If a problem occurs, firstly check the following:

1. Are the connections correct?

2. Is the set being operated as described in the owner's manual?



3. Are other components operating properly?

If this unit does not operate properly, check the items listed in the table below. If the problem continues there may be a malfunction.

In this case, disconnect the power immediately and contact your retail outlet.

Symptom	Cause / Countermeasure	Page
Power does not turn on.	• Check if the power cord is properly connected.	20
	• Plug the power supply cord into the power outlet.	–
	• The safety protection device may be activated. Unplug the power cord once, and wait for 5-10 seconds and then plug it in again.	–
Unable to play back BD-LIVE / bonus view.	• The safety function puts the DBP-A100 into the standby status when the fan stops. Check the back of the set to see if something is keeping the fan from rotating.	3, 9
	• Does the SD Memory Card have more than 1GB of available space?	4, 36
No picture appears.	• Has the SD Memory Card been initialized by the DBP-A100?	31
	• Was the SD Memory Card inserted while the power of the unit was on. (Insert the SD Memory Card while the DBP-A100 is in the standby status.)	4, 36
	• Remove the write protection of the SD Memory Card.	–
No picture appears.	• Switch the TV's input setting to the external input connected to the player.	–
	• Is the Pure Direct function set to "On"? Set it to "Off". Also, is "Pure Direct Setup" – "Video Out" on the GUI menu set to "Off" at the "User Preset 1" or "User Preset 2" setting? Set it to "On".	28, 38
	• Is the HDMI mode set to "HDMI On"? In this case, video signals are output from the video, S-Video and HDMI terminals, but not from the component terminals.	13
	• Check the connection of the video/S-Video/component video cable.	18
	• Is the GUI menu "HDMI Setup" – "I/P Direct" set to "On"? If so, no video signals are output from the video and S-Video terminals during playback of certain discs.	23
	• Does the "Video Setup" – "Component Resolution" setting on the GUI menu match the connected device's resolution? Set it so that it matches.	24

Symptom	Cause / Countermeasure	Page
Video and audio are not output via the HDMI connection.	• Check the connection of the HDMI cable.	13
	• Is the "HDMI" indicator on the display of the DBP-A100 lit? • Is the Pure Direct function set to "On"? Set it to "Off". Also, is "Pure Direct Setup" – "Video Out" on the GUI menu set to "Off" at the "User Preset 1" or "User Preset 2" setting? Set it to "On".	8 28, 38
HD audio is not output.	• Is the HDMI mode set to "HDMI Off"? If so, video signals are output from the video and S-Video terminals, but not from the HDMI terminal.	13
	• Check whether the connected display device or other device supports HDCP. This unit will not output a video signal unless the other device supports HDCP. See the owner's manual of your TV, AV Amp, etc.	15
	• Check that the setting of the HDMI video resolution supports the resolution of the connected device. When set to "Auto", DBP-A100 makes the setting automatically.	13
The picture is not displayed or is disrupted. The picture of a BD-Video or DVD-Video disc is in black and white.	• Set "BD Audio Mode" to "HD Audio Output".	32
The picture may be slightly disturbed right after fast-forwarding or reversing. This is not a malfunction.	• Connect the DBP-A100's video/S-Video/component video output either directly to the TV or to the TV via the AV Amp. Do not connect via a VCR, (video cassette recorder). Some discs include copy prohibit signals, and when such discs are played via a VCR the copy guard system may disrupt the picture.	–
	• Is a disc that is not compatible with the player or a disc with a different region number loaded? (This player supports region code "A" for BD-Video discs, "1" or "ALL" for DVD-Video discs.)	18
	• Is the GUI menu "HDMI Setup" – "I/P Direct" set to "On"? If so, no video signals are output from the video and S-Video terminals during playback of certain discs.	3
		23

Symptom	Cause / Countermeasure	Page
No sound or the sound is hard to hear.	• Check the audio connections of connected devices and speakers.	11 ~ 20
	• Is the power connected audio devices turned on? Is the input selection set to the input to which the DBP-A100 is connected? • Is the audio output properly selected?	– 13 ~ 20
The picture freezes momentarily during playback.	• If a disc is scratched or contaminated with fingerprints, the disc may not play correctly. Clean the disc or replace with a non-scratched disc. • There may be a problem with the data recorded on the disc.	6 –
Playback does not start even when ► is pressed, or starts but stops immediately.	• Is there condensation inside the player or on the disc? (Let it sit for 1 to 2 hours with the power off.)	3
	• When the disc is scratched or contaminated with fingerprints, the disc may not play correctly. Clean the disc or replace with a non-scratched disc.	6
	• Is the disc loaded upside-down? Load the disc properly, with the side to be played face down. • Is an unplayable disc loaded?	6 3, 4
Subtitles are not displayed.	• Subtitles cannot be displayed for BD-Video, DVD-Video or DivX® files that do not contain subtitles.	46
	• Is the subtitle setting “Off”? Use the disc menu or  to set the subtitles to display.	23
My SD Memory Card cannot be read.	• The format of the card does not match this unit or the card is not compatible.	31
	• Is the playback media mode set to “SD CARD MODE”? Select “SD CARD MODE” with  .	34
No return to start-up screen when a disc is removed.	• There may be an internal error. Set the power to standby, wait awhile, then turn the power back on.	–
The set cannot be operated with the remote control.	• Aim the remote control directly at the infrared sensor window on the front of the unit.	7
	• Operate within a distance of 7 meters from the remote control sensor.	7
	• Remove any obstacles.	–
	• Replace the batteries with new ones.	7
	• Insert the batteries in the proper direction, checking the ⊕ and ⊖ marks.	7
	• Match the signal code of the remote control to the signal code of the unit.	7

Symptom	Cause / Countermeasure	Page
The unit is operated by the remote control of an other DENON product.	• The unit is designed to be operated by the remote controls of other DENON products.	7, 31
	• To avoid the unit being operated by the remote controls of other devices, set “Other Setup” – “Remote Control Setting” – “Receive Legacy Remocon” to “Off” on the GUI menu.	31
Buttons do not work or the unit stops responding.	• Operations may not be permitted by the disc.	–
	• The safety protection device may be activated. Unplug the power cord once, and wait for 5-10 seconds and then plug it in again. • Refer to the instructions of the disc.	– –
A playable disc is not read.	• The pickup lens may be dirty. Before requesting servicing, try cleaning the laser pickup with a commercially available lens cleaner. (Do not use a cleaner with a brush because it may damage the lens.)	–
The camera angle does not switch.	• If the multiple angles are not recorded in a BD-Video or DVD-Video, the camera angle cannot be switched. Also, multiple angles may only be recorded for specific scenes.	47
Playback does not start when a title is selected.	• Playback may be prohibited by the viewing restriction setting. Check the “Ratings” setting on the GUI menu.	29
I have forgotten the password for the rating level.	• On the GUI menu, perform the “Other Setup” – “Initialize” procedure.	31



- Some functions may not be used under certain operating conditions, but this is not failure of the unit. Read the description in this Owner’s Manual for details on correct operations.
- The volume may differ from disc to disc. This is due to the differences in how the signals are recorded on the disc and is not a malfunction.
- During programmed playback, it is not possible to perform random playback or to start playback from a desired track or file.
- Some functions are prohibited on some discs.

Specifications

Audio performance

- Signal format :** NTSC
- Applicable discs /memory cards :**
- (1) BD-Video discs :
12 cm, 1 side, 1 layer; 12 cm, 1 side, 2 layers
 - (2) DVD-Video / DVD-Audio discs :
12 cm, 1 side, 1 layer; 12 cm, 1 side, 2 layers /
12 cm, 2 sides, 2 layers (1 side, 1 layer)
8 cm, 1 side, 1 layer; 8 cm, 1 side, 2 layers /
8 cm, 2 sides, 2 layers (1 side, 1 layer)
 - (3) Super Audio CDs :
12 cm, 1 layer / 12 cm, 2 layer / 12 cm, Hybrid
 - (4) Compact Discs (CD-DA) :
12 cm, / 8 cm, discs
 - (5) Memory cards :
SD Memory Card / SDHC Memory Card / miniSD Card /
microSD Card

- S-Video output :** Y output level : 1Vp-p (75 Ω)
C output level : 0.286 Vp-p
Output terminal : S-Video, 1 set
- Video output :** Output level : 1Vp-p (75 Ω)
Output terminal : Pin-jack, 1 set
- Component video output :** Y output level : 1Vp-p (75 Ω)
Pb/Cb output level / Pr/Cr output level : 0.648 Vp-p (75 Ω)
Output terminal : Pin-jack, 1 set
- HDMI output :** Output terminal : 19-pin HDMI terminals, 1 set
HDMI ver. 1.3a
(Deep Colour, Dolby Digital Plus, Dolby TrueHD, DTS-HD)

- Analog audio output :** Output level : 2 Vrms (10 kΩ)
2 channels output terminal : Pin-jack, 1 set
7.1 channels output terminal : Pin-jack, 1 set

- Audio output characteristics :**
- (1) Frequency response
 - ① BD (Multi linear PCM) : 2Hz ~ 22kHz (48kHz sampling)
: 2Hz ~ 44kHz (96kHz sampling)
: 2Hz ~ 88kHz (192kHz sampling)
 - ② DVD (Multi linear PCM) : 2Hz ~ 22kHz (48kHz sampling)
: 2Hz ~ 44kHz (96kHz sampling)
: 2Hz ~ 88kHz (192kHz sampling)
 - ③ Super Audio CD : 2Hz ~ 100kHz
 - ④ CD : 2Hz ~ 20kHz
 - (2) S/N ratio : 125dB
 - (3) Total harmonic distortion : 1kHz 0.0008%
 - (4) Dynamic range : 110dB

- Digital audio output :** Optical digital output: Optical connector, 1 set
Coaxial digital output: Pin jack, 1 set

General

- Power supply :** AC 120 V, 60 Hz
- Power consumption :** 55 W
(☞ page 31 "Power Saving")
- When in Power Saving Standby : 0.3 W
 - When in Normal Standby : 0.8 W
 - When in Quick Start Mode :
20 ~ 35 W (Changes according to connection status, etc.)
- Maximum external dimensions :** 434 (W) x 137 (H) x 383 (D) mm (17-3/32" x 5-25/64" x 15-5/64")
- Weight :** 11.3 kg (24 lbs)

Remote control unit (RC-1140)

- Remote control type :** Infrared pulse
- Batteries :** R6/AA Type (two batteries)
- Maximum external dimensions :** 58 (W) x 230 (H) x 37 (D) mm (2-9/32" x 9-1/16" x 1-29/64")
- Weight :** 205 g (Approx. 7.2 oz) (included batteries)

* For purposes of improvement, specifications and design are subject to change without notice.

License

This section describes software license used for DBP-A100. To maintain the correct content, the original (English) is used.

□ Exhibit-A

GNU GENERAL PUBLIC LICENSE

Version 2, June 1991

Copyright (C) 1989, 1991

Free Software Foundation, Inc. 59 Temple Place, Suite 330, Boston, MA 02111-1307 USA

Everyone is permitted to copy and distribute verbatim copies of this license document, but changing it is not allowed.

Preamble

The licenses for most software are designed to take away your freedom to share and change it. By contrast, the GNU General Public

License is intended to guarantee your freedom to share and change free software—to make sure the software is free for all its users. This General Public License applies to most of the Free Software Foundation's software and to any other program whose authors commit to using it. (Some other Free Software Foundation software is covered by the GNU Library General Public License instead.) You can apply it to your programs, too.

When we speak of free software, we are referring to freedom, not price. Our General Public Licenses are designed to make sure that you have the freedom to distribute copies of free software (and charge for this service if you wish), that you receive source code or can get it if you want it, that you can change the software or use pieces of it in new free programs; and that you know you can do these things.

To protect your rights, we need to make restrictions that forbid anyone to deny you these rights or to ask you to surrender the rights. These restrictions translate to certain responsibilities for you if you distribute copies of the software, or if you modify it.

For example, if you distribute copies of such a program, whether gratis or for a fee, you must give the recipients all the rights that you have. You must make sure that they, too, receive or can get the source code. And you must show them these terms so they know their rights.

We protect your rights with two steps: (1) copyright the software, and (2) offer you this license which gives you legal permission to copy, distribute and/or modify the software.

Also, for each author's protection and ours, we want to make certain that everyone understands that there is no warranty for this free software. If the software is modified by someone else and passed on, we want its recipients to know that what they have is not the original, so that any problems introduced by others will not reflect on the original authors' reputations.

Finally, any free program is threatened constantly by software patents. We wish to avoid the danger that redistributors of a free program will individually obtain patent licenses, in effect making the program proprietary. To prevent this, we have made it clear that any patent must be licensed for everyone's free use or not licensed at all.

The precise terms and conditions for copying, distribution and modification follow.

TERMS AND CONDITIONS FOR COPYING, DISTRIBUTION AND MODIFICATION

0. This License applies to any program or other work which contains a notice placed by the copyright holder saying it may be distributed under the terms of this General Public License. The "Program", below, refers to any such program or work, and a "work based on the Program" means either the Program or any derivative work under copyright law: that is to say, a work containing the Program or a portion of it, either verbatim or with modifications and/or translated into another language. (Hereinafter, translation is included without limitation in the term "modification".) Each licensee is addressed as "you".

Activities other than copying, distribution and modification are not covered by this License; they are outside its scope. The act of running the Program is not restricted, and the output from the Program is covered only if its contents constitute a work based on the Program (independent of having been made by running the Program). Whether that is true depends on what the Program does.

1. You may copy and distribute verbatim copies of the Program's source code as you receive it, in any medium, provided that you conspicuously and appropriately publish on each copy an appropriate copyright notice and disclaimer of warranty; keep intact all the notices that refer to this License and to the absence of any warranty; and give any other recipients of the Program a copy of this License along with the Program.

You may charge a fee for the physical act of transferring a copy, and you may at your option offer warranty protection in exchange for a fee.

2. You may modify your copy or copies of the Program or any portion of it, thus forming a work based on the Program, and copy and distribute such modifications or work under the terms of Section 1 above, provided that you also meet all of these conditions:

a) You must cause the modified files to carry prominent notices stating that you changed the files and the date of any change.

b) You must cause any work that you distribute or publish, that in whole or in part contains or is derived from the Program or any part thereof, to be licensed as a whole at no charge to all third parties under the terms of this License.

c) If the modified program normally reads commands interactively when run, you must cause it, when started running for such interactive use in the most ordinary way, to print or display an announcement including an appropriate copyright notice and a notice that there is no warranty (or else, saying that you provide a warranty) and that users may redistribute the program under these conditions, and telling the user how to view a copy of this License.

(Exception: if the Program itself is interactive but does not normally print such an announcement, your work based on the Program is not required to print an announcement.)

These requirements apply to the modified work as a whole. If identifiable sections of that work are not derived from the Program, and can be reasonably considered independent and separate works in themselves, then this License, and its terms, do not apply to those sections when you distribute them as separate works. But when you distribute the same sections as part of a whole which is a work based on the Program, the distribution of the whole must be on the terms of this License, whose permissions for other licensees extend to the entire whole, and thus to each and every part regardless of who wrote it.

Thus, it is not the intent of this section to claim rights or contest your rights to work written entirely by you; rather, the intent is to exercise the right to control the distribution of derivative or collective works based on the Program.

In addition, mere aggregation of another work not based on the Program with the Program (or with a work based on the Program) on a volume of a storage or distribution medium does not bring the other work under the scope of this License.

3. You may copy and distribute the Program (or a work based on it, under Section 2) in object code or executable form under the terms of Sections 1 and 2 above provided that you also do one of the following:

a) Accompany it with the complete corresponding machine-readable source code, which must be distributed under the terms of Sections 1 and 2 above on a medium customarily used for software interchange; or,

b) Accompany it with a written offer, valid for at least three years, to give any third party, for a charge no more than your cost of physically performing source distribution, a complete machine-readable copy of the corresponding source code, to be distributed under the terms of Sections 1 and 2 above on a medium customarily used for software interchange; or,

c) Accompany it with the information you received as to the offer to distribute corresponding source code. (This alternative is allowed only for noncommercial distribution and only if you received the program in object code or executable form with such an offer, in accord with Subsection b above.)

The source code for a work means the preferred form of the work for making modifications to it. For an executable work, complete source code means all the source code for all modules it contains, plus any associated interface definition files, plus the scripts used to control compilation and installation of the executable.

However, as a special exception, the source code distributed need not include anything that is normally distributed (in either source or binary form) with the major components (compiler, kernel, and so on) of the operating system on which the executable runs, unless that component itself accompanies the executable.

If distribution of executable or object code is made by offering access to copy from a designated place, then offering equivalent access to copy the source code from the same place counts as distribution of the source code, even though third parties are not compelled to copy the source along with the object code.

4. You may not copy, modify, sublicense, or distribute the Program except as expressly provided under this License. Any attempt otherwise to copy, modify, sublicense or distribute the Program is void, and will automatically terminate your rights under this License. However, parties who have received copies, or rights, from you under this License will not have their licenses terminated so long as such parties remain in full compliance.

5. You are not required to accept this License, since you have not signed it. However, nothing else grants you permission to modify or distribute the Program or its derivative works. These actions are prohibited by law if you do not accept this License. Therefore, by modifying or distributing the Program (or any work based on the Program), you indicate your acceptance of this License to do so, and all its terms and conditions for copying, distributing or modifying the Program or works based on it.

6. Each time you redistribute the Program (or any work based on the Program), the recipient automatically receives a license from the original licensor to copy, distribute or modify the Program subject to these terms and conditions. You may not impose any further restrictions on the recipients' exercise of the rights granted herein.

You are not responsible for enforcing compliance by third parties to this License.

7. If, as a consequence of a court judgment or allegation of patent infringement or for any other reason (not limited to patent issues), conditions are imposed on you (whether by court order, agreement or otherwise) that contradict the conditions of this License, they do not excuse you from the conditions of this License. If you cannot distribute so as to satisfy simultaneously your obligations under this License and any other pertinent obligations, then as a consequence you may not distribute the Program at all. For example, if a patent license would not permit royalty-free redistribution of the Program by all those who receive copies directly or indirectly through you, then the only way you could satisfy both it and this License would be to refrain entirely from distribution of the Program. If any portion of this section is held invalid or unenforceable under any particular circumstance, the balance of the section is intended to apply and the section as a whole is intended to apply in other circumstances.

It is not the purpose of this section to induce you to infringe any patents or other property right claims or to contest validity of any such claims; this section has the sole purpose of protecting the integrity of the free software distribution system, which is implemented by public license practices. Many people have made generous contributions to the wide range of software distributed through that system in reliance on consistent application of that system; it is up to the author/donor to decide if he or she is willing to distribute software through any other system and a licensee cannot impose that choice.

This section is intended to make thoroughly clear what is believed to be a consequence of the rest of this License.

8. If the distribution and/or use of the Program is restricted in certain countries either by patents or by copyrighted interfaces, the original copyright holder who places the Program under this License may add an explicit geographical distribution limitation excluding those countries, so that distribution is permitted only in or among countries not thus excluded. In such case, this License incorporates the limitation as if written in the body of this License.
9. The Free Software Foundation may publish revised and/or new versions of the General Public License from time to time. Such new versions will be similar in spirit to the present version, but may differ in detail to address new problems or concerns. Each version is given a distinguishing version number. If the Program specifies a version number of this License which applies to it and “any later version”, you have the option of following the terms and conditions either of that version or of any later version published by the Free Software Foundation. If the Program does not specify a version number of this License, you may choose any version ever published by the Free Software Foundation.
10. If you wish to incorporate parts of the Program into other free programs whose distribution conditions are different, write to the author to ask for permission. For software which is copyrighted by the Free Software Foundation, write to the Free Software Foundation; we sometimes make exceptions for this. Our decision will be guided by the two goals of preserving the free status of all derivatives of our free software and of promoting the sharing and reuse of software generally.

NO WARRANTY

11. BECAUSE THE PROGRAM IS LICENSED FREE OF CHARGE, THERE IS NO WARRANTY FOR THE PROGRAM, TO THE EXTENT PERMITTED BY APPLICABLE LAW. EXCEPT WHEN OTHERWISE STATED IN WRITING THE COPYRIGHT HOLDERS AND/OR OTHER PARTIES PROVIDE THE PROGRAM “AS IS” WITHOUT WARRANTY OF ANY KIND, EITHER EXPRESSED OR IMPLIED, INCLUDING, BUT NOT LIMITED TO, THE IMPLIED WARRANTIES OF MERCHANTABILITY AND FITNESS FOR A PARTICULAR PURPOSE. THE ENTIRE RISK AS TO THE QUALITY AND PERFORMANCE OF THE PROGRAM IS WITH YOU. SHOULD THE PROGRAM PROVE DEFECTIVE, YOU ASSUME THE COST OF ALL NECESSARY SERVICING, REPAIR OR CORRECTION.
12. IN NO EVENT UNLESS REQUIRED BY APPLICABLE LAW OR AGREED TO IN WRITING WILL ANY COPYRIGHT HOLDER, OR ANY OTHER PARTY WHO MAY MODIFY AND/OR REDISTRIBUTE THE PROGRAM AS PERMITTED ABOVE, BE LIABLE TO YOU FOR DAMAGES, INCLUDING ANY GENERAL, SPECIAL, INCIDENTAL OR CONSEQUENTIAL DAMAGES ARISING OUT OF THE USE OR INABILITY TO USE THE PROGRAM (INCLUDING BUT NOT LIMITED TO LOSS OF DATA OR DATA BEING RENDERED INACCURATE OR LOSSES SUSTAINED BY YOU OR THIRD PARTIES OR A FAILURE OF THE PROGRAM TO OPERATE WITH ANY OTHER PROGRAMS), EVEN IF SUCH HOLDER OR OTHER PARTY HAS BEEN ADVISED OF THE POSSIBILITY OF SUCH DAMAGES.

END OF TERMS AND CONDITIONS

How to Apply These Terms to Your New Programs

If you develop a new program, and you want it to be of the greatest possible use to the public, the best way to achieve this is to make it free software which everyone can redistribute and change under these terms.

To do so, attach the following notices to the program. It is safest to attach them to the start of each source file to most effectively convey the exclusion of warranty; and each file should have at least the “copyright” line and a pointer to where the full notice is found.

<one line to give the program’s name and a brief idea of what it does.>

Copyright (C) <year> <name of author>

This program is free software; you can redistribute it and/or modify it under the terms of the GNU General Public License as published by the Free Software Foundation; either version 2 of the License, or (at your option) any later version.

This program is distributed in the hope that it will be useful, but WITHOUT ANY WARRANTY; without even the implied warranty of MERCHANTABILITY or FITNESS FOR A PARTICULAR PURPOSE. See the GNU General Public License for more details.

You should have received a copy of the GNU General Public License along with this program; if not, write to the Free Software Foundation, Inc., 59 Temple Place, Suite 330, Boston, MA 02111-1307 USA

Also add information on how to contact you by electronic and paper mail.

If the program is interactive, make it output a short notice like this when it starts in an interactive mode:

Gnomovision version 69, Copyright (C) year name of author

Gnomovision comes with ABSOLUTELY NO WARRANTY; for details type ‘show w’. This is free software, and you are welcome to redistribute it under certain conditions; type ‘show c’ for details.

The hypothetical commands ‘show w’ and ‘show c’ should show the appropriate parts of the General Public License. Of course, the commands you use may be called something other than ‘show w’ and ‘show c’; they could even be mouse-clicks or menu items—whatever suits your program.

You should also get your employer (if you work as a programmer) or your school, if any, to sign a “copyright disclaimer” for the program, if necessary. Here is a sample; alter the names:

Yoyodyne, Inc., hereby disclaims all copyright interest in the program ‘Gnomovision’ (which makes passes at compilers) written by James Hacker.

<signature of Ty Coon>, 1 April 1989

Ty Coon, President of Vice

This General Public License does not permit incorporating your program into proprietary programs. If your program is a subroutine library, you may consider it more useful to permit linking proprietary applications with the library. If this is what you want to do, use the GNU Library General Public License instead of this License.

Exhibit-B

GNU LESSER GENERAL PUBLIC LICENSE

Version 2.1, February 1999

Copyright (C) 1991, 1999 Free Software Foundation, Inc.
59 Temple Place, Suite 330, Boston, MA 02111-1307 USA

Everyone is permitted to copy and distribute verbatim copies of this license document, but changing it is not allowed.

[This is the first released version of the Lesser GPL. It also counts as the successor of the GNU Library Public License, version 2, hence the version number 2.1.]

Preamble

The licenses for most software are designed to take away your freedom to share and change it. By contrast, the GNU General Public Licenses are intended to guarantee your freedom to share and change free software—to make sure the software is free for all its users.

This license, the Lesser General Public License, applies to some specially designated software packages—typically libraries—of the Free Software Foundation and other authors who decide to use it. You can use it too, but we suggest you first think carefully about whether this license or the ordinary General Public License is the better strategy to use in any particular case, based on the explanations below.

When we speak of free software, we are referring to freedom of use, not price. Our General Public Licenses are designed to make sure that you have the freedom to distribute copies of free software (and charge for this service if you wish); that you receive source code or can get it if you want it; that you can change the software and use pieces of it in new free programs; and that you are informed that you can do these things.

To protect your rights, we need to make restrictions that forbid distributors to deny you these rights or to ask you to surrender these rights. These restrictions translate to certain responsibilities for you if you distribute copies of the library or if you modify it.

For example, if you distribute copies of the library, whether gratis or for a fee, you must give the recipients all the rights that we gave you. You must make sure that they, too, receive or can get the source code. If you link other code with the library, you must provide complete object files to the recipients, so that they can relink them with the library after making changes to the library and recompiling it. And you must show them these terms so they know their rights. We protect your rights with a two-step method: (1) we copyright the library, and (2) we offer you this license, which gives you legal permission to copy, distribute and/or modify the library.

To protect each distributor, we want to make it very clear that there is no warranty for the free library. Also, if the library is modified by someone else and passed on, the recipients should know that what they have is not the original version, so that the original author’s reputation will not be affected by problems that might be introduced by others.

Finally, software patents pose a constant threat to the existence of any free program. We wish to make sure that a company cannot effectively restrict the users of a free program by obtaining a restrictive license from a patent holder. Therefore, we insist that any patent license obtained for a version of the library must be consistent with the full freedom of use specified in this license.

Most GNU software, including some libraries, is covered by the ordinary GNU General Public License. This license, the GNU Lesser General Public License, applies to certain designated libraries, and is quite different from the ordinary General Public License. We use this license for certain libraries in order to permit linking those libraries into non-free programs.

When a program is linked with a library, whether statically or using a shared library, the combination of the two is legally speaking a combined work, a derivative of the original library. The ordinary General Public License therefore permits such linking only if the entire combination fits its criteria of freedom. The Lesser General Public License permits more lax criteria for linking other code with the library.

We call this license the “Lesser” General Public License because it does Less to protect the user’s freedom than the ordinary General Public License. It also provides other free software developers Less of an advantage over competing non-free programs. These disadvantages are the reason we use the ordinary General Public License for many libraries. However, the Lesser license provides advantages in certain special circumstances.

For example, on rare occasions, there may be a special need to encourage the widest possible use of a certain library, so that it becomes a de-facto standard. To achieve this, non-free programs must be allowed to use the library. A more frequent case is that a free library does the same job as widely used non-free libraries. In this case, there is little to gain by limiting the free library to free software only, so we use the Lesser General Public License.

In other cases, permission to use a particular library in non-free programs enables a greater number of people to use a large body of free software. For example, permission to use the GNU C Library in non-free programs enables many more people to use the whole GNU operating system, as well as its variant, the GNU/Linux operating system.

Although the Lesser General Public License is Less protective of the users’ freedom, it does ensure that the user of a program that is linked with the Library has the freedom and the wherewithal to run that program using a modified version of the Library.

The precise terms and conditions for copying, distribution and modification follow. Pay close attention to the difference between a “work based on the library” and a “work that uses the library”.

The former contains code derived from the library, whereas the latter must be combined with the library in order to run.



TERMS AND CONDITIONS FOR COPYING, DISTRIBUTION AND MODIFICATION

0. This License Agreement applies to any software library or other program which contains a notice placed by the copyright holder or other authorized party saying it may be distributed under the terms of this Lesser General Public License (also called "this License"). Each licensee is addressed as "you".
- A "library" means a collection of software functions and/or data prepared so as to be conveniently linked with application programs (which use some of those functions and data) to form executables.
- The "Library", below, refers to any such software library or work which has been distributed under these terms. A "work based on the Library" means either the Library or any derivative work under copyright law: that is to say, a work containing the Library or a portion of it, either verbatim or with modifications and/or translated straightforwardly into another language. (Hereinafter, translation is included without limitation in the term "modification".)
- "Source code" for a work means the preferred form of the work for making modifications to it. For a library, complete source code means all the source code for all modules it contains, plus any associated interface definition files, plus the scripts used to control compilation and installation of the library.
- Activities other than copying, distribution and modification are not covered by this License; they are outside its scope. The act of running a program using the Library is not restricted, and output from such a program is covered only if its contents constitute a work based on the Library (independent of the use of the Library in a tool for writing it). Whether that is true depends on what the Library does and what the program that uses the Library does.
1. You may copy and distribute verbatim copies of the Library's complete source code as you receive it, in any medium, provided that you conspicuously and appropriately publish on each copy an appropriate copyright notice and disclaimer of warranty; keep intact all the notices that refer to this License and to the absence of any warranty; and distribute a copy of this License along with the Library.
You may charge a fee for the physical act of transferring a copy, and you may at your option offer warranty protection in exchange for a fee.
 2. You may modify your copy or copies of the Library or any portion of it, thus forming a work based on the Library, and copy and distribute such modifications or work under the terms of Section 1 above, provided that you also meet all of these conditions:
 - a) The modified work must itself be a software library.
 - b) You must cause the files modified to carry prominent notices stating that you changed the files and the date of any change.
 - c) You must cause the whole of the work to be licensed at no charge to all third parties under the terms of this License.
 - d) If a facility in the modified Library refers to a function or a table of data to be supplied by an application program that uses the facility, other than as an argument passed when the facility is invoked, then you must make a good faith effort to ensure that,

in the event an application does not supply such function or table, the facility still operates, and performs whatever part of its purpose remains meaningful.

(For example, a function in a library to compute square roots has a purpose that is entirely well-defined independent of the application. Therefore, Subsection 2d requires that any application-supplied function or table used by this function must be optional: if the application does not supply it, the square root function must still compute square roots.)

These requirements apply to the modified work as a whole. If identifiable sections of that work are not derived from the Library, and can be reasonably considered independent and separate works in themselves, then this License, and its terms, do not apply to those sections when you distribute them as separate works. But when you distribute the same sections as part of a whole which is a work based on the Library, the distribution of the whole must be on the terms of this License, whose permissions for other licensees extend to the entire whole, and thus to each and every part regardless of who wrote it.

Thus, it is not the intent of this section to claim rights or contest your rights to work written entirely by you; rather, the intent is to exercise the right to control the distribution of derivative or collective works based on the Library.

In addition, mere aggregation of another work not based on the Library with the Library (or with a work based on the Library) on a volume of a storage or distribution medium does not bring the other work under the scope of this License.

3. You may opt to apply the terms of the ordinary GNU General Public License instead of this License to a given copy of the Library. To do this, you must alter all the notices that refer to this License, so that they refer to the ordinary GNU General Public License, version 2, instead of to this License. (If a newer version than version 2 of the ordinary GNU General Public License has appeared, then you can specify that version instead if you wish.) Do not make any other change in these notices.

Once this change is made in a given copy, it is irreversible for that copy, so the ordinary GNU General Public License applies to all subsequent copies and derivative works made from that copy.

This option is useful when you wish to copy part of the code of the Library into a program that is not a library.

4. You may copy and distribute the Library (or a portion or derivative of it, under Section 2) in object code or executable form under the terms of Sections 1 and 2 above provided that you accompany it with the complete corresponding machine-readable source code, which must be distributed under the terms of Sections 1 and 2 above on a medium customarily used for software interchange.

If distribution of object code is made by offering access to copy from a designated place, then offering equivalent access to copy the source code from the same place satisfies the requirement to distribute the source code, even though third parties are not compelled to copy the source along with the object code.

5. A program that contains no derivative of any portion of the Library, but is designed to work with the Library by being compiled or linked with it, is called a "work that uses the Library". Such a work, in isolation, is not a derivative work of the Library, and therefore falls outside the scope of this License.

However, linking a "work that uses the Library" with the Library creates an executable that is a derivative of the Library (because it contains portions of the Library), rather than a "work that uses the library". The executable is therefore covered by this License.

Section 6 states terms for distribution of such executables.

When a "work that uses the Library" uses material from a header file that is part of the Library, the object code for the work may be a derivative work of the Library even though the source code is not.

Whether this is true is especially significant if the work can be linked without the Library, or if the work is itself a library. The threshold for this to be true is not precisely defined by law.

If such an object file uses only numerical parameters, data structure layouts and accessors, and small macros and small inline functions (ten lines or less in length), then the use of the object file is unrestricted, regardless of whether it is legally a derivative work. (Executables containing this object code plus portions of the Library will still fall under Section 6.)

Otherwise, if the work is a derivative of the Library, you may distribute the object code for the work under the terms of Section 6. Any executables containing that work also fall under Section 6, whether or not they are linked directly with the Library itself.

6. As an exception to the Sections above, you may also combine or link a "work that uses the Library" with the Library to produce a work containing portions of the Library, and distribute that work under terms of your choice, provided that the terms permit modification of the work for the customer's own use and reverse engineering for debugging such modifications. You must give prominent notice with each copy of the work that the Library is used in it and that the Library and its use are covered by this License. You must supply a copy of this License. If the work during execution displays copyright notices, you must include the copyright notice for the Library among them, as well as a reference directing the user to the copy of this License. Also, you must do one of these things:

- a) Accompany the work with the complete corresponding machine-readable source code for the Library including whatever changes were used in the work (which must be distributed under Sections 1 and 2 above); and, if the work is an executable linked with the Library, with the complete machine-readable "work that uses the Library", as object code and/or source code, so that the user can modify the Library and then relink to produce a modified executable containing the modified Library. (It is understood that the user who changes the contents of definitions files in the Library will not necessarily be able to recompile the application to use the modified definitions.)

- b) Use a suitable shared library mechanism for linking with the Library. A suitable mechanism is one that (1) uses at run time a copy of the library already present on the user's computer system, rather than copying library functions into the executable, and (2) will operate properly with a modified version of the library, if the user installs one, as long as the modified version is interface-compatible with the version that the work was made with.

- c) Accompany the work with a written offer, valid for at least three years, to give the same user the materials specified in Subsection 6a, above, for a charge no more than the cost of performing this distribution.

- d) If distribution of the work is made by offering access to copy from a designated place, offer equivalent access to copy the above specified materials from the same place.

- e) Verify that the user has already received a copy of these materials or that you have already sent this user a copy.

For an executable, the required form of the "work that uses the Library" must include any data and utility programs needed for reproducing the executable from it. However, as a special exception, the materials to be distributed need not include anything that is normally distributed (in either source or binary form) with the major components (compiler, kernel, and so on) of the operating system on which the executable runs, unless that component itself accompanies the executable.

It may happen that this requirement contradicts the license restrictions of other proprietary libraries that do not normally accompany the operating system. Such a contradiction means you cannot use both them and the Library together in an executable that you distribute.

7. You may place library facilities that are a work based on the Library side-by-side in a single library together with other library facilities not covered by this License, and distribute such a combined library, provided that the separate distribution of the work based on the Library and of the other library facilities is otherwise permitted, and provided that you do these two things:

- a) Accompany the combined library with a copy of the same work based on the Library, uncombined with any other library facilities. This must be distributed under the terms of the Sections above.

- b) Give prominent notice with the combined library of the fact that part of it is a work based on the Library, and explaining where to find the accompanying uncombined form of the same work.

8. You may not copy, modify, sublicense, link with, or distribute the Library except as expressly provided under this License. Any attempt otherwise to copy, modify, sublicense, link with, or distribute the Library is void, and will automatically terminate your rights under this License. However, parties who have received copies, or rights, from you under this License will not have their licenses terminated so long as such parties remain in full compliance.

9. You are not required to accept this License, since you have not signed it. However, nothing else grants you permission to modify or distribute the Library or its derivative works. These actions are prohibited by law if you do not accept this License. Therefore, by modifying or distributing the Library (or any work based on the Library), you indicate your acceptance of this License to do so, and all its terms and conditions for copying, distributing or modifying the Library or works based on it.
10. Each time you redistribute the Library (or any work based on the Library), the recipient automatically receives a license from the original licensor to copy, distribute, link with or modify the Library subject to these terms and conditions. You may not impose any further restrictions on the recipients' exercise of the rights granted herein. You are not responsible for enforcing compliance by third parties with this License.
11. If, as a consequence of a court judgment or allegation of patent infringement or for any other reason (not limited to patent issues), conditions are imposed on you (whether by court order, agreement or otherwise) that contradict the conditions of this License, they do not excuse you from the conditions of this License. If you cannot distribute so as to satisfy simultaneously your obligations under this License and any other pertinent obligations, then as a consequence you may not distribute the Library at all. For example, if a patent license would not permit royalty-free redistribution of the Library by all those who receive copies directly or indirectly through you, then the only way you could satisfy both it and this License would be to refrain entirely from distribution of the Library. If any portion of this section is held invalid or unenforceable under any particular circumstance, the balance of the section is intended to apply, and the section as a whole is intended to apply in other circumstances. It is not the purpose of this section to induce you to infringe any patents or other property right claims or to contest validity of any such claims; this section has the sole purpose of protecting the integrity of the free software distribution system which is implemented by public license practices. Many people have made generous contributions to the wide range of software distributed through that system in reliance on consistent application of that system; it is up to the author/donor to decide if he or she is willing to distribute software through any other system and a licensee cannot impose that choice. This section is intended to make thoroughly clear what is believed to be a consequence of the rest of this License.
12. If the distribution and/or use of the Library is restricted in certain countries either by patents or by copyrighted interfaces, the original copyright holder who places the Library under this License may add an explicit geographical distribution limitation excluding those countries, so that distribution is permitted only in or among countries not thus excluded. In such case, this License incorporates the limitation as if written in the body of this License.

13. The Free Software Foundation may publish revised and/or new versions of the Lesser General Public License from time to time. Such new versions will be similar in spirit to the present version, but may differ in detail to address new problems or concerns. Each version is given a distinguishing version number. If the Library specifies a version number of this License which applies to it and "any later version", you have the option of following the terms and conditions either of that version or of any later version published by the Free Software Foundation. If the Library does not specify a license version number, you may choose any version ever published by the Free Software Foundation.
14. If you wish to incorporate parts of the Library into other free programs whose distribution conditions are incompatible with these, write to the author to ask for permission. For software which is copyrighted by the Free Software Foundation, write to the Free Software Foundation; we sometimes make exceptions for this. Our decision will be guided by the two goals of preserving the free status of all derivatives of our free software and of promoting the sharing and reuse of software generally.

NO WARRANTY

15. BECAUSE THE LIBRARY IS LICENSED FREE OF CHARGE, THERE IS NO WARRANTY FOR THE LIBRARY, TO THE EXTENT PERMITTED BY APPLICABLE LAW. EXCEPT WHEN OTHERWISE STATED IN WRITING THE COPYRIGHT HOLDERS AND/OR OTHER PARTIES PROVIDE THE LIBRARY "AS IS" WITHOUT WARRANTY OF ANY KIND, EITHER EXPRESSED OR IMPLIED, INCLUDING, BUT NOT LIMITED TO, THE IMPLIED WARRANTIES OF MERCHANTABILITY AND FITNESS FOR A PARTICULAR PURPOSE. THE ENTIRE RISK AS TO THE QUALITY AND PERFORMANCE OF THE LIBRARY IS WITH YOU. SHOULD THE LIBRARY PROVE DEFECTIVE, YOU ASSUME THE COST OF ALL NECESSARY SERVICING, REPAIR OR CORRECTION.
16. IN NO EVENT UNLESS REQUIRED BY APPLICABLE LAW OR AGREED TO IN WRITING WILL ANY COPYRIGHT HOLDER, OR ANY OTHER PARTY WHO MAY MODIFY AND/OR REDISTRIBUTE THE LIBRARY AS PERMITTED ABOVE, BE LIABLE TO YOU FOR DAMAGES, INCLUDING ANY GENERAL, SPECIAL, INCIDENTAL OR CONSEQUENTIAL DAMAGES ARISING OUT OF THE USE OR INABILITY TO USE THE LIBRARY (INCLUDING BUT NOT LIMITED TO LOSS OF DATA OR DATA BEING RENDERED INACCURATE OR LOSSES SUSTAINED BY YOU OR THIRD PARTIES OR A FAILURE OF THE LIBRARY TO OPERATE WITH ANY OTHER SOFTWARE), EVEN IF SUCH HOLDER OR OTHER PARTY HAS BEEN ADVISED OF THE POSSIBILITY OF SUCH DAMAGES.

END OF TERMS AND CONDITIONS

How to Apply These Terms to Your New Libraries

If you develop a new library, and you want it to be of the greatest possible use to the public, we recommend making it free software that everyone can redistribute and change. You can do so by permitting redistribution under these terms (or, alternatively, under the terms of the ordinary General Public License).

To apply these terms, attach the following notices to the library. It is safest to attach them to the start of each source file to most effectively convey the exclusion of warranty; and each file should have at least the "copyright" line and a pointer to where the full notice is found.

<one line to give the library's name and a brief idea of what it does.>

Copyright (C) <year> <name of author>

This library is free software; you can redistribute it and/or modify it under the terms of the GNU Lesser General Public License as published by the Free Software Foundation; either version 2.1 of the License, or (at your option) any later version.

This library is distributed in the hope that it will be useful, but WITHOUT ANY WARRANTY; without even the implied warranty of MERCHANTABILITY or FITNESS FOR A PARTICULAR PURPOSE. See the GNU Lesser General Public License for more details.

You should have received a copy of the GNU Lesser General Public License along with this library; if not, write to the Free Software Foundation, Inc., 59 Temple Place, Suite 330, Boston, MA 02111-1307 USA

Also add information on how to contact you by electronic and paper mail.

You should also get your employer (if you work as a programmer) or your school, if any, to sign a "copyright disclaimer" for the library, if necessary. Here is a sample; alter the names:

Yoyodyne, Inc., hereby disclaims all copyright interest in the library 'Frob' (a library for tweaking knobs) written by James Random Hacker.

<signature of Ty Coon>, 1 April 1990

Ty Coon, President of Vice

That's all there is to it!

Exhibit-C

Copyright notice:

(C) 1995-2004 Jean-loup Gailly and Mark Adler

This software is provided 'as-is', without any express or implied warranty. In no event will the authors be held liable for any damages arising from the use of this software.

Permission is granted to anyone to use this software for any purpose, including commercial applications, and to alter it and redistribute it freely, subject to the following restrictions:

1. The origin of this software must not be misrepresented; you must not claim that you wrote the original software. If you use this software in a product, an acknowledgment in the product documentation would be appreciated but is not required.
 2. Altered source versions must be plainly marked as such, and must not be misrepresented as being the original software.
 3. This notice may not be removed or altered from any source distribution.
- Jean-loup Gailly Mark Adler
jloup@gzip.org madler@alumni.caltech.edu

If you use the zlib library in a product, we would appreciate *not* receiving lengthy legal documents to sign. The sources are provided for free but without warranty of any kind. The library has been entirely written by Jean-loup Gailly and Mark Adler; it does not include third-party code.

If you redistribute modified sources, we would appreciate that you include in the file ChangeLog history information documenting your changes. Please read the FAQ for more information on the distribution of modified source versions.

Exhibit-D

Copyright (c) 1998, 1999, 2000 Thai Open Source Software Center Ltd and Clark Cooper

Copyright (c) 2001, 2002 Expat maintainers.

Permission is hereby granted, free of charge, to any person obtaining a copy of this software and associated documentation files (the "Software"), to deal in the Software without restriction, including without limitation the rights to use, copy, modify, merge, publish, distribute, sublicense, and/or sell copies of the Software, and to permit persons to whom the Software is furnished to do so, subject to the following conditions:

The above copyright notice and this permission notice shall be included in all copies or substantial portions of the Software.

THE SOFTWARE IS PROVIDED "AS IS", WITHOUT WARRANTY OF ANY KIND, EXPRESS OR IMPLIED, INCLUDING BUT NOT LIMITED TO THE WARRANTIES OF MERCHANTABILITY, FITNESS FOR A PARTICULAR PURPOSE AND NONINFRINGEMENT.

IN NO EVENT SHALL THE AUTHORS OR COPYRIGHT HOLDERS BE LIABLE FOR ANY CLAIM, DAMAGES OR OTHER LIABILITY, WHETHER IN AN ACTION OF CONTRACT, TORT OR OTHERWISE, ARISING FROM, OUT OF OR IN CONNECTION WITH THE SOFTWARE OR THE USE OR OTHER DEALINGS IN THE SOFTWARE.

Exhibit-E

The Independent JPEG Group's JPEG software README for release 6b of 27-Mar-1998

This distribution contains the sixth public release of the Independent JPEG Group's free JPEG software. You are welcome to redistribute this software and to use it for any purpose, subject to the conditions under LEGAL ISSUES, below.

Serious users of this software (particularly those incorporating it into larger programs) should contact IJG at jpeg-info@uunet.uu.net to be added to our electronic mailing list. Mailing list members are notified of updates and have a chance to participate in technical discussions, etc.

This software is the work of Tom Lane, Philip Gladstone, Jim Boucher, Lee Crocker, Julian Minguiillon, Luis Ortiz, George Phillips, Davide Rossi, Guido Vollbeding, Ge' Weijers, and other members of the Independent JPEG Group.

IJG is not affiliated with the official ISO JPEG standards committee.

DOCUMENTATION ROADMAP

This file contains the following sections:

OVERVIEW	General description of JPEG and the IJG software.
LEGAL ISSUES	Copyright, lack of warranty, terms of distribution.
REFERENCES	Where to learn more about JPEG.
ARCHIVE LOCATIONS	Where to find newer versions of this software.
RELATED SOFTWARE	Other stuff you should get.
FILE FORMAT WARS	Software *not* to get.
TO DO	Plans for future IJG releases.

Other documentation files in the distribution are:
User documentation:

install.doc	How to configure and install the IJG software.
usage.doc	Usage instructions for cjpeg, djpeg, jpegtran, rdjpgcom, and wrjpgcom.
*.1	Unix-style man pages for programs (same info as usage.doc).
wizard.doc	Advanced usage instructions for JPEG wizards only.
change.log	Version-to-version change highlights.
Programmer and internal documentation:	
libjpeg.doc	How to use the JPEG library in your own programs.
example.c	Sample code for calling the JPEG library.
structure.doc	Overview of the JPEG library's internal structure.
filelist.doc	Road map of IJG files.
coderrules.doc	Coding style rules — please read if you contribute code.

Please read at least the files install.doc and usage.doc. Useful information can also be found in the JPEG FAQ (Frequently Asked Questions) article. See ARCHIVE LOCATIONS below to find out where to obtain the FAQ article.

If you want to understand how the JPEG code works, we suggest reading one or more of the REFERENCES, then looking at the documentation files (in roughly the order listed) before diving into the code.

OVERVIEW

This package contains C software to implement JPEG image compression and decompression. JPEG (pronounced "jay-peg") is a standardized compression method for full-color and gray-scale images. JPEG is intended for compressing "real-world" scenes; line drawings, cartoons and other non-realistic images are not its strong suit. JPEG is lossy, meaning that the output image is not exactly identical to the input image. Hence you must not use JPEG if you have to have identical output bits. However, on typical photographic images, very good compression levels can be obtained with no visible change, and remarkably high compression levels are possible if you can tolerate a low-quality image. For more details, see the references, or just experiment with various compression settings.

This software implements JPEG baseline, extended-sequential, and progressive compression processes. Provision is made for supporting all variants of these processes, although some uncommon parameter settings aren't implemented yet.

For legal reasons, we are not distributing code for the arithmetic-coding variants of JPEG; see LEGAL ISSUES. We have made no provision for supporting the hierarchical or lossless processes defined in the standard.

We provide a set of library routines for reading and writing JPEG image files, plus two sample applications "cjpeg" and "djpeg", which use the library to perform conversion between JPEG and some other popular image file formats.

The library is intended to be reused in other applications. In order to support file conversion and viewing software, we have included considerable functionality beyond the bare JPEG coding/decoding capability; for example, the color quantization modules are not strictly part of JPEG decoding, but they are essential for output to colormapped file formats or colormapped displays. These extra functions can be compiled out of the library if not required for a particular application. We have also included "jpegtran", a utility for lossless transcoding between different JPEG processes, and "rdjpgcom" and "wrjpgcom", two simple applications for inserting and extracting textual comments in JFIF files.

The emphasis in designing this software has been on achieving portability and flexibility, while also making it fast enough to be useful. In particular, the software is not intended to be read as a tutorial on JPEG. (See the REFERENCES section for introductory material.) Rather, it is intended to be reliable, portable, industrial-strength code. We do not claim to have achieved that goal in every aspect of the software, but we strive for it.

We welcome the use of this software as a component of commercial products.

No royalty is required, but we do ask for an acknowledgement in product documentation, as described under LEGAL ISSUES.

LEGAL ISSUES

In plain English:

1. We don't promise that this software works. (But if you find any bugs, please let us know!)
2. You can use this software for whatever you want. You don't have to pay us.
3. You may not pretend that you wrote this software. If you use it in a program, you must acknowledge somewhere in your documentation that you've used the IJG code.

In legalese:

The authors make NO WARRANTY or representation, either express or implied, with respect to this software, its quality, accuracy, merchantability, or fitness for a particular purpose. This software is provided "AS IS", and you, its user, assume the entire risk as to its quality and accuracy. This software is copyright (C) 1991-1998, Thomas G. Lane.

All Rights Reserved except as specified below.

Permission is hereby granted to use, copy, modify, and distribute this software (or portions thereof) for any purpose, without fee, subject to these conditions:

- (1) If any part of the source code for this software is distributed, then this README file must be included, with this copyright and no-warranty notice unaltered; and any additions, deletions, or changes to the original files must be clearly indicated in accompanying documentation.
- (2) If only executable code is distributed, then the accompanying documentation must state that "this software is based in part on the work of the Independent JPEG Group".
- (3) Permission for use of this software is granted only if the user accepts full responsibility for any undesirable consequences; the authors accept NO LIABILITY for damages of any kind.

These conditions apply to any software derived from or based on the IJG code, not just to the unmodified library. If you use our work, you ought to acknowledge us.

Permission is NOT granted for the use of any IJG author's name or company name in advertising or publicity relating to this software or products derived from it. This software may be referred to only as "the Independent JPEG Group's software".

We specifically permit and encourage the use of this software as the basis of commercial products, provided that all warranty or liability claims are assumed by the product vendor.

ansi2knr.c is included in this distribution by permission of L. Peter Deutsch, sole proprietor of its copyright holder, Aladdin Enterprises of Menlo Park, CA.

ansi2knr.c is NOT covered by the above copyright and conditions, but instead by the usual distribution terms of the Free Software Foundation; principally, that you must include source code if you redistribute it. (See the file ansi2knr.c for full details.) However, since ansi2knr.c is not needed as part of any program generated from the IJG code, this does not limit you more than the foregoing paragraphs do.

The Unix configuration script "configure" was produced with GNU Autoconf.

It is copyright by the Free Software Foundation but is freely distributable.

The same holds for its supporting scripts (config.guess, config.sub, ltconfig, ltmain.sh). Another support script, install-sh, is copyright by M.I.T. but is also freely distributable.

It appears that the arithmetic coding option of the JPEG spec is covered by patents owned by IBM, AT&T, and Mitsubishi. Hence arithmetic coding cannot legally be used without obtaining one or more licenses. For this reason, support for arithmetic coding has been removed from the free JPEG software.

(Since arithmetic coding provides only a marginal gain over the unpatented Huffman mode, it is unlikely that very many implementations will support it.)

So far as we are aware, there are no patent restrictions on the remaining code.

The IJG distribution formerly included code to read and write GIF files.

To avoid entanglement with the Unisys LZW patent, GIF reading support has been removed altogether, and the GIF writer has been simplified to produce "uncompressed GIFs". This technique does not use the LZW algorithm; the resulting GIF files are larger than usual, but are readable by all standard GIF decoders.

We are required to state that

"The Graphics Interchange Format(c) is the Copyright property of CompuServe Incorporated. GIF(sm) is a Service Mark property of CompuServe Incorporated."

REFERENCES

We highly recommend reading one or more of these references before trying to understand the innards of the JPEG software.

The best short technical introduction to the JPEG compression algorithm is

Wallace, Gregory K. "The JPEG Still Picture Compression Standard", Communications of the ACM, April 1991 (vol. 34 no. 4), pp. 30-44.

(Adjacent articles in that issue discuss MPEG motion picture compression, applications of JPEG, and related topics.) If you don't have the CACM issue handy, a PostScript file containing a revised version of Wallace's article is available at ftp://ftp.uu.net/graphics/jpeg/wallace.ps.gz. The file (actually a preprint for an article that appeared in IEEE Trans. Consumer Electronics) omits the sample images that appeared in CACM, but it includes corrections and some added material. Note: the Wallace article is copyright ACM and IEEE, and it may not be used for commercial purposes.

A somewhat less technical, more leisurely introduction to JPEG can be found in "The Data Compression Book" by Mark Nelson and Jean-loup Gailly, published by M&T Books (New York), 2nd ed. 1996, ISBN 1-55851-434-1. This book provides good explanations and example C code for a multitude of compression methods including JPEG. It is an excellent source if you are comfortable reading C code but don't know much about data compression in general. The book's JPEG sample code is far from industrial-strength, but when you are ready to look at a full implementation, you've got one here...

The best full description of JPEG is the textbook "JPEG Still Image Data Compression Standard" by William B. Pennebaker and Joan L. Mitchell, published by Van Nostrand Reinhold, 1993, ISBN 0-442-01272-1. Price US\$59.95, 638 pp.

The book includes the complete text of the ISO JPEG standards (DIS 10918-1 and draft DIS 10918-2).

This is by far the most complete exposition of JPEG in existence, and we highly recommend it.

The JPEG standard itself is not available electronically; you must order a paper copy through ISO or ITU. (Unless you feel a need to own a certified official copy, we recommend buying the Pennebaker and Mitchell book instead; it's much cheaper and includes a great deal of useful explanatory material.)

In the USA, copies of the standard may be ordered from ANSI Sales at (212) 642-4900, or from Global Engineering Documents at (800) 854-7179. (ANSI doesn't take credit card orders, but Global does.) It's not cheap: as of 1992, ANSI was charging \$95 for Part 1 and \$47 for Part 2, plus 7% shipping/handling. The standard is divided into two parts, Part 1 being the actual specification, while Part 2 covers compliance testing methods. Part 1 is titled "Digital Compression and Coding of Continuous-tone Still Images, Part 1: Requirements and guidelines" and has document numbers ISO/IEC IS 10918-1, ITU-T T.81. Part 2 is titled "Digital Compression and Coding of Continuous-tone Still Images, Part 2: Compliance testing" and has document numbers ISO/IEC IS 10918-2, ITU-T T.83.

Some extensions to the original JPEG standard are defined in JPEG Part 3, a newer ISO standard numbered ISO/IEC IS 10918-3 and ITU-T T.84. IJG currently does not support any Part 3 extensions.

The JPEG standard does not specify all details of an interchangeable file format. For the omitted details we follow the "JFIF" conventions, revision 1.02. A copy of the JFIF spec is available from:

Literature Department
C-Cube Microsystems, Inc.
1778 McCarthy Blvd.
Milpitas, CA 95035
phone (408) 944-6300, fax (408) 944-6314



A PostScript version of this document is available by FTP at <ftp://ftp.uu.net/graphics/jpeg/jfif.ps.gz>. There is also a plain text version at <ftp://ftp.uu.net/graphics/jpeg/jfif.txt.gz>, but it is missing the figures.

The TIFF 6.0 file format specification can be obtained by FTP from <ftp://ftp.sgi.com/graphics/tiff/TIFF6.ps.gz>. The JPEG incorporation scheme found in the TIFF 6.0 spec of 3-June-92 has a number of serious problems.

IJG does not recommend use of the TIFF 6.0 design (TIFF Compression tag 6).

Instead, we recommend the JPEG design proposed by TIFF Technical Note #2 (Compression tag 7). Copies of this Note can be obtained from <ftp.sgi.com> or from <ftp://ftp.uu.net/graphics/jpeg/>. It is expected that the next revision of the TIFF spec will replace the 6.0 JPEG design with the Note's design.

Although IJG's own code does not support TIFF/JPEG, the free libtiff library uses our library to implement TIFF/JPEG per the Note. libtiff is available from <ftp://ftp.sgi.com/graphics/tiff/>.

ARCHIVE LOCATIONS

The "official" archive site for this software is <ftp.uu.net> (Internet address 192.48.96.9). The most recent released version can always be found there in directory `graphics/jpeg`. This particular version will be archived as <ftp://ftp.uu.net/graphics/jpeg/jpegsrvc6b.tar.gz>.

If you don't have direct Internet access, UUNET's archives are also available via UUCP; contact help@uunet.uu.net for information on retrieving files that way.

Numerous Internet sites maintain copies of the UUNET files. However, only <ftp.uu.net> is guaranteed to have the latest official version.

You can also obtain this software in DOS-compatible "zip" archive format from the SimTel archives (<ftp://ftp.simtel.net/pub/simtelnet/msdos/graphics/>), or on CompuServe in the Graphics Support forum (GO CIS:GRAPHSUP), library 12 "JPEG Tools". Again, these versions may sometimes lag behind the <ftp.uu.net> release.

The JPEG FAQ (Frequently Asked Questions) article is a useful source of general information about JPEG. It is updated constantly and therefore is not included in this distribution. The FAQ is posted every two weeks to Usenet newsgroups `comp.graphics.misc`, `news.answers`, and other groups.

It is available on the World Wide Web at <http://www.faqs.org/faqs/jpeg-faq/> and other `news.answers` archive sites, including the official `news.answers` archive at <rtfm.mit.edu>: <ftp://rtfm.mit.edu/pub/usenet/news.answers/jpeg-faq/>.

If you don't have Web or FTP access, send e-mail to mail-server@rtfm.mit.edu with body

send usenet/news.answers/jpeg-faq/part1

send usenet/news.answers/jpeg-faq/part2

RELATED SOFTWARE

Numerous viewing and image manipulation programs now support JPEG. (Quite a few of them use this library to do so.) The JPEG FAQ described above lists some of the more popular free and shareware viewers, and tells where to obtain them on Internet.

If you are on a Unix machine, we highly recommend Jef Poskanzer's free PBMPPLUS software, which provides many useful operations on PPM-format image files. In particular, it can convert PPM images to and from a wide range of other formats, thus making `cjpeg/djpeg` considerably more useful. The latest version is distributed by the NetPBM group, and is available from numerous sites, notably <ftp://wuarchive.wustl.edu/graphics/graphics/packages/NetPBM/>.

Unfortunately PBMPPLUS/NETPBM is not nearly as portable as the IJG software is; you are likely to have difficulty making it work on any non-Unix machine.

A different free JPEG implementation, written by the PVRG group at Stanford,

is available from <ftp://havefun.stanford.edu/pub/jpeg/>. This program is designed for research and experimentation rather than production use; it is slower, harder to use, and less portable than the IJG code, but it is easier to read and modify. Also, the PVRG code supports lossless JPEG, which we do not. (On the other hand, it doesn't do progressive JPEG.)

FILE FORMAT WARS

Some JPEG programs produce files that are not compatible with our library.

The root of the problem is that the ISO JPEG committee failed to specify a concrete file format. Some vendors "filled in the blanks" on their own, creating proprietary formats that no one else could read. (For example, none of the early commercial JPEG implementations for the Macintosh were able to exchange compressed files.)

The file format we have adopted is called JFIF (see REFERENCES). This format has been agreed to by a number of major commercial JPEG vendors, and it has become the de facto standard. JFIF is a minimal or "low end" representation.

We recommend the use of TIFF/JPEG (TIFF revision 6.0 as modified by TIFF Technical Note #2) for "high end" applications that need to record a lot of additional data about an image. TIFF/JPEG is fairly new and not yet widely supported, unfortunately.

The upcoming JPEG Part 3 standard defines a file format called SPIFF.

SPIFF is interoperable with JFIF, in the sense that most JFIF decoders should be able to read the most common variant of SPIFF. SPIFF has some technical advantages over JFIF, but its major claim to fame is simply that it is an official standard rather than an informal one. At this point it is unclear whether SPIFF will supersede JFIF or whether JFIF will remain the de-facto standard. IJG intends to support SPIFF once the standard is frozen, but we have not decided whether it should become our default output format or not.

(In any case, our decoder will remain capable of reading JFIF indefinitely.)

Various proprietary file formats incorporating JPEG compression also exist.

We have little or no sympathy for the existence of these formats. Indeed, one of the original reasons for developing this free software was to help force convergence on common, open format standards for JPEG files. Don't use a proprietary file format!

TO DO

The major thrust for v7 will probably be improvement of visual quality.

The current method for scaling the quantization tables is known not to be very good at low Q values. We also intend to investigate block boundary smoothing, "poor man's variable quantization", and other means of improving quality-vs-file-size performance without sacrificing compatibility.

In future versions, we are considering supporting some of the upcoming JPEG Part 3 extensions — principally, variable quantization and the SPIFF file format.

As always, speeding things up is of great interest.

Please send bug reports, offers of help, etc. to jpeg-info@uunet.uu.net.

□ Exhibit-F

COPYRIGHT NOTICE, DISCLAIMER, and LICENSE:

If you modify libpng you may insert additional notices immediately following this sentence.

libpng version 1.2.6, August 15, 2004, is Copyright (c) 2004 Glenn Randers-Pehrson, and is distributed according to the same disclaimer and license as libpng-1.2.5 with the following individual added to the list of Contributing Authors

Cosmin Truta

libpng versions 1.0.7, July 1, 2000, through 1.2.5 - October 3, 2002, are Copyright (c) 2000-2002 Glenn Randers-Pehrson, and are distributed according to the same disclaimer and license as libpng-1.0.6 with the following individuals added to the list of Contributing Authors

Simon-Pierre Cadieux

Eric S. Raymond

Gilles Vollant

and with the following additions to the disclaimer:

There is no warranty against interference with your enjoyment of the library or against infringement. There is no warranty that our efforts or the library will fulfill any of your particular purposes or needs. This library is provided with all faults, and the entire risk of satisfactory quality, performance, accuracy, and effort is with the user.

libpng versions 0.97, January 1998, through 1.0.6, March 20, 2000, are Copyright (c) 1998, 1999 Glenn Randers-Pehrson, and are distributed according to the same disclaimer and license as libpng-0.96, with the following individuals added to the list of Contributing Authors:

Tom Lane

Glenn Randers-Pehrson

Willem van Schaik

libpng versions 0.89, June 1996, through 0.96, May 1997, are Copyright (c) 1996, 1997 Andreas Dilger Distributed according to the same disclaimer and license as libpng-0.88, with the following individuals added to the list of Contributing Authors:

John Bowler

Kevin Bracey

Sam Bushell

Magnus Holmgren

Greg Roelofs

Tom Tanner

libpng versions 0.5, May 1995, through 0.88, January 1996, are Copyright (c) 1995, 1996 Guy Eric Schalnat, Group 42, Inc.

For the purposes of this copyright and license, "Contributing Authors" is defined as the following set of individuals:

Andreas Dilger

Dave Martindale

Guy Eric Schalnat

Paul Schmidt

Tim Wegner

The PNG Reference Library is supplied "AS IS". The Contributing Authors and Group 42, Inc. disclaim all warranties, expressed or implied, including, without limitation, the warranties of merchantability and of fitness for any purpose. The Contributing Authors and Group 42, Inc. assume no liability for direct, indirect, incidental, special, exemplary, or consequential damages, which may result from the use of the PNG Reference Library, even if advised of the possibility of such damage.

Permission is hereby granted to use, copy, modify, and distribute this source code, or portions hereof, for any purpose, without fee, subject to the following restrictions:

1. The origin of this source code must not be misrepresented.
2. Altered versions must be plainly marked as such and must not be misrepresented as being the original source.
3. This Copyright notice may not be removed or altered from any source or altered source distribution.

The Contributing Authors and Group 42, Inc. specifically permit, without fee, and encourage the use of this source code as a component to supporting the PNG file format in commercial products. If you use this source code in a product, acknowledgment is not required but would be appreciated.

A "png_get_copyright" function is available, for convenient use in "about" boxes and the like: `printf("%s", png_get_copyright(NULL))`; Also, the PNG logo (in PNG format, of course) is supplied in the files "pngbar.png" and "pngbar.jpg (88x31)" and "pngnow.png" (98x31).

Libpng is OSI Certified Open Source Software. OSI Certified Open Source is a certification mark of the Open Source Initiative.

Glenn Randers-Pehrson

glennrp@users.sourceforge.net

August 15, 2004

□ Exhibit-G

Copyright (c) 2001,2003 Keith Packard

Permission to use, copy, modify, distribute, and sell this software and its documentation for any purpose is hereby granted without fee, provided that the above copyright notice appear in all copies and that both that copyright notice and this permission notice appear in supporting documentation, and that the name of Keith Packard not be used in advertising or publicity pertaining to distribution of the software without specific, written prior permission. Keith Packard makes no representations about the suitability of this software for any purpose. It is provided "as is" without express or implied warranty.

KEITH PACKARD DISCLAIMS ALL WARRANTIES WITH REGARD TO THIS SOFTWARE, INCLUDING ALL IMPLIED WARRANTIES OF MERCHANTABILITY AND FITNESS, IN NO EVENT SHALL KEITH PACKARD BE LIABLE FOR ANY SPECIAL, INDIRECT OR CONSEQUENTIAL DAMAGES OR ANY DAMAGES WHATSOEVER RESULTING FROM LOSS OF USE, DATA OR PROFITS, WHETHER IN AN ACTION OF CONTRACT, NEGLIGENCE OR OTHER TORTIOUS ACTION, ARISING OUT OF OR IN CONNECTION WITH THE USE OR PERFORMANCE OF THIS SOFTWARE.

Exhibit-H

The FreeType Project LICENSE

2002-Apr-11 Copyright 1996-2002 by David Turner, Robert Wilhelm, and Werner Lemberg

Introduction

The FreeType Project is distributed in several archive packages; some of them may contain, in addition to the FreeType font engine, various tools and contributions which rely on, or relate to, the FreeType Project.

This license applies to all files found in such packages, and which do not fall under their own explicit license. The license affects thus the FreeType font engine, the test programs, documentation and makefiles, at the very least.

This license was inspired by the BSD, Artistic, and IJG (Independent JPEG Group) licenses, which all encourage inclusion and use of free software in commercial and freeware products alike. As a consequence, its main points are that:

- We don't promise that this software works. However, we will be interested in any kind of bug reports. ('as is' distribution)
- You can use this software for whatever you want, in parts or full form, without having to pay us. ('royalty-free' usage)
- You may not pretend that you wrote this software. If you use it, or only parts of it, in a program, you must acknowledge somewhere in your documentation that you have used the FreeType code. ('credits')

We specifically permit and encourage the inclusion of this software, with or without modifications, in commercial products.

We disclaim all warranties covering The FreeType Project and assume no liability related to The FreeType Project.

Finally, many people asked us for a preferred form for a credit/disclaimer to use in compliance with this license. We thus encourage you to use the following text:

Portions of this software are copyright © 1996-2002 The FreeType Project (www.freetype.org). All rights reserved.

Legal Terms

0. Definitions

Throughout this license, the terms 'package', 'FreeType Project', and 'FreeType archive' refer to the set of files originally distributed by the authors (David Turner, Robert Wilhelm, and Werner Lemberg) as the 'FreeType Project', be they named as alpha, beta or final release.

'You' refers to the licensee, or person using the project, where 'using' is a generic term including compiling the project's source code as well as linking it to form a 'program' or 'executable'.

This program is referred to as 'a program using the FreeType engine'.

This license applies to all files distributed in the original FreeType Project, including all source code, binaries and documentation, unless otherwise stated in the file in its original, unmodified form as distributed in the original archive.

If you are unsure whether or not a particular file is covered by this license, you must contact us to verify this.

The FreeType Project is copyright (C) 1996-2000 by David Turner, Robert Wilhelm, and Werner Lemberg. All rights reserved except as specified below.

1. No Warranty

THE FREETYPE PROJECT IS PROVIDED 'AS IS' WITHOUT WARRANTY OF ANY KIND, EITHER EXPRESS OR IMPLIED, INCLUDING, BUT NOT LIMITED TO, WARRANTIES OF MERCHANTABILITY AND FITNESS FOR A PARTICULAR PURPOSE. IN NO EVENT WILL ANY OF THE AUTHORS OR COPYRIGHT HOLDERS BE LIABLE FOR ANY DAMAGES CAUSED BY THE USE OR THE INABILITY TO USE, OF THE FREETYPE PROJECT.

2. Redistribution

This license grants a worldwide, royalty-free, perpetual and irrevocable right and license to use, execute, perform, compile, display, copy, create derivative works of, distribute and sublicense the FreeType Project (in both source and object code forms) and derivative works thereof for any purpose; and to authorize others to exercise some or all of the rights granted herein, subject to the following conditions:

- Redistribution of source code must retain this license file ('FTL.TXT') unaltered; any additions, deletions or changes to the original files must be clearly indicated in accompanying documentation. The copyright notices of the unaltered, original files must be preserved in all copies of source files.
- Redistribution in binary form must provide a disclaimer that states that the software is based in part of the work of the FreeType Team, in the distribution documentation. We also encourage you to put an URL to the FreeType web page in your documentation, though this isn't mandatory.

These conditions apply to any software derived from or based on the FreeType Project, not just the unmodified files. If you use our work, you must acknowledge us. However, no fee need be paid to us.

3. Advertising

Neither the FreeType authors and contributors nor you shall use the name of the other for commercial, advertising, or promotional purposes without specific prior written permission.

We suggest, but do not require, that you use one or more of the following phrases to refer to this software in your documentation or advertising materials: 'FreeType Project', 'FreeType Engine', 'FreeType library', or 'FreeType Distribution'.

As you have not signed this license, you are not required to accept it. However, as the FreeType Project is copyrighted material, only this license, or another one contracted with the authors, grants you the right to use, distribute, and modify it.

Therefore, by using, distributing, or modifying the FreeType Project, you indicate that you understand and accept all the terms of this license.

4. Contacts

There are two mailing lists related to FreeType:

- freetype@freetype.org
Discusses general use and applications of FreeType, as well as future and wanted additions to the library and distribution.
If you are looking for support, start in this list if you haven't found anything to help you in the documentation.
- devel@freetype.org
Discusses bugs, as well as engine internals, design issues, specific licenses, porting, etc.

- <http://www.freetype.org>

Holds the current FreeType web page, which will allow you to download our latest development version and read online documentation.

You can also contact us individually at:

- David Turner <david.turner@freetype.org>
- Robert Wilhelm <robert.wilhelm@freetype.org>
- Werner Lemberg <werner.lemberg@freetype.org>

Exhibit-I

* This document is freely plagiarised from the 'Artistic Licence', distributed as part of the Perl v4.0 kit by Larry Wall, which is available from most major archive sites

This documents purpose is to state the conditions under which these Packages (See definition below) viz: "Crack", the Unix Password Cracker, and "CrackLib", the Unix Password Checking library, which are held in copyright by Alec David Edward Muffett, may be copied, such that the copyright holder maintains some semblance of artistic control over the development of the packages, while giving the users of the package the right to use and distribute the Package in a more-or-less customary fashion, plus the right to make reasonable modifications.

So there.

Definitions:

A "Package" refers to the collection of files distributed by the Copyright Holder, and derivatives of that collection of files created through textual modification, or segments thereof.

"Standard Version" refers to such a Package if it has not been modified, or has been modified in accordance with the wishes of the Copyright Holder.

"Copyright Holder" is whoever is named in the copyright or copyrights for the package.

"You" is you, if you're thinking about copying or distributing this Package.

"Reasonable copying fee" is whatever you can justify on the basis of media cost, duplication charges, time of people involved, and so on. (You will not be required to justify it to the Copyright Holder, but only to the computing community at large as a market that must bear the fee.) "Freely Available" means that no fee is charged for the item itself, though there may be fees involved in handling the item. It also means that recipients of the item may redistribute it under the same conditions they received it.

1. You may make and give away verbatim copies of the source form of the Standard Version of this Package without restriction, provided that you duplicate all of the original copyright notices and associated disclaimers.
2. You may apply bug fixes, portability fixes and other modifications derived from the Public Domain or from the Copyright Holder. A Package modified in such a way shall still be considered the Standard Version.
3. You may otherwise modify your copy of this Package in any way, provided that you insert a prominent notice in each changed file stating how and when AND WHY you changed that file, and provided that you do at least ONE of the following:
 - a) place your modifications in the Public Domain or otherwise make them Freely Available, such as by posting said modifications to Usenet or an equivalent medium, or placing the modifications on a major archive site such as uunet.uu.net, or by allowing the Copyright Holder to include your modifications in the Standard Version of the Package.

b) use the modified Package only within your corporation or organization.

c) rename any non-standard executables so the names do not conflict with standard executables, which must also be provided, and provide separate documentation for each non-standard executable that clearly documents how it differs from the Standard Version.

d) make other distribution arrangements with the Copyright Holder.

4. You may distribute the programs of this Package in object code or executable form, provided that you do at least ONE of the following:

a) distribute a Standard Version of the executables and library files, together with instructions (in the manual page or equivalent) on where to get the Standard Version.

b) accompany the distribution with the machine-readable source of the Package with your modifications.

c) accompany any non-standard executables with their corresponding Standard Version executables, giving the non-standard executables non-standard names, and clearly documenting the differences in manual pages (or equivalent), together with instructions on where to get the Standard Version.

d) make other distribution arrangements with the Copyright Holder.

5. You may charge a reasonable copying fee for any distribution of this Package. You may charge any fee you choose for support of this Package.

YOU MAY NOT CHARGE A FEE FOR THIS PACKAGE ITSELF. However, you may distribute this Package in aggregate with other (possibly commercial) programs as part of a larger (possibly commercial) software distribution provided that YOU DO NOT ADVERTISE this package as a product of your own.

6. The name of the Copyright Holder may not be used to endorse or promote products derived from this software without specific prior written permission.

7. THIS PACKAGE IS PROVIDED "AS IS" AND WITHOUT ANY EXPRESS OR IMPLIED WARRANTIES, INCLUDING, WITHOUT LIMITATION, THE IMPLIED WARRANTIES OF MERCHANTABILITY AND FITNESS FOR A PARTICULAR PURPOSE.

Exhibit-J

Unless otherwise "explicitly" stated, the following text describes the licensed conditions under which the contents of this libcap release may be used and distributed:

Redistribution and use in source and binary forms of libcap, with or without modification, are permitted provided that the following conditions are met:

1. Redistributions of source code must retain any existing copyright notice, and this entire permission notice in its entirety, including the disclaimer of warranties.
2. Redistributions in binary form must reproduce all prior and current copyright notices, this list of conditions, and the following disclaimer in the documentation and/or other materials provided with the distribution.
3. The name of any author may not be used to endorse or promote products derived from this software without their specific prior written permission.

ALTERNATIVELY, this product may be distributed under the terms of the GNU General Public License, in which case the provisions of the GNU GPL are required INSTEAD OF the above restrictions. (This clause is necessary due to a potential conflict between the GNU GPL and the restrictions contained in a BSD-style copyright.)

THIS SOFTWARE IS PROVIDED "AS IS" AND ANY EXPRESS OR IMPLIED WARRANTIES, INCLUDING, BUT NOT LIMITED TO, THE IMPLIED WARRANTIES OF MERCHANTABILITY AND FITNESS FOR A PARTICULAR PURPOSE ARE DISCLAIMED.

IN NO EVENT SHALL THE AUTHOR(S) BE LIABLE FOR ANY DIRECT, INDIRECT, INCIDENTAL, SPECIAL, EXEMPLARY, OR CONSEQUENTIAL DAMAGES (INCLUDING, BUT NOT LIMITED TO, PROCUREMENT OF SUBSTITUTE GOODS OR SERVICES; LOSS OF USE, DATA, OR PROFITS; OR BUSINESS INTERRUPTION) HOWEVER CAUSED AND ON ANY THEORY OF LIABILITY, WHETHER IN CONTRACT, STRICT LIABILITY, OR TORT (INCLUDING NEGLIGENCE OR OTHERWISE) ARISING IN ANY WAY OUT OF THE USE OF THIS SOFTWARE, EVEN IF ADVISED OF THE POSSIBILITY OF SUCH DAMAGE.

□ Exhibit-K

Copyright 1995 by Wietse Venema. All rights reserved. Some individual files may be covered by other copyrights. This material was originally written and compiled by Wietse Venema at Eindhoven University of Technology, The Netherlands, in 1990, 1991, 1992, 1993, 1994 and 1995.

Redistribution and use in source and binary forms are permitted provided that this entire copyright notice is duplicated in all such copies.

This software is provided "as is" and without any expressed or implied warranties, including, without limitation, the implied warranties of merchantability and fitness for any particular purpose.

□ Exhibit-L

Copyright (c) 1989 The Regents of the University of California.

All rights reserved.

Redistribution and use in source and binary forms, with or without modification, are permitted provided that the following conditions are met:

1. Redistributions of source code must retain the above copyright notice, this list of conditions and the following disclaimer.
2. Redistributions in binary form must reproduce the above copyright notice, this list of conditions and the following disclaimer in the documentation and/or other materials provided with the distribution.
3. All advertising materials mentioning features or use of this software must display the following acknowledgement:
This product includes software developed by the University of California, Berkeley and its contributors.
4. Neither the name of the University nor the names of its contributors may be used to endorse or promote products derived from this software without specific prior written permission.

THIS SOFTWARE IS PROVIDED BY THE REGENTS AND CONTRIBUTORS "AS IS" AND ANY EXPRESS OR IMPLIED WARRANTIES, INCLUDING, BUT NOT LIMITED TO, THE IMPLIED WARRANTIES OF MERCHANTABILITY AND FITNESS FOR A PARTICULAR PURPOSE ARE DISCLAIMED. IN NO EVENT SHALL THE REGENTS OR CONTRIBUTORS BE LIABLE FOR ANY DIRECT, INDIRECT, INCIDENTAL, SPECIAL, EXEMPLARY, OR CONSEQUENTIAL DAMAGES (INCLUDING, BUT NOT LIMITED TO, PROCUREMENT OF SUBSTITUTE GOODS OR SERVICES; LOSS OF USE, DATA, OR PROFITS; OR BUSINESS INTERRUPTION) HOWEVER CAUSED AND ON ANY THEORY OF LIABILITY, WHETHER IN CONTRACT, STRICT LIABILITY, OR TORT (INCLUDING NEGLIGENCE OR OTHERWISE) ARISING IN ANY WAY OUT OF THE USE OF THIS SOFTWARE, EVEN IF ADVISED OF THE POSSIBILITY OF SUCH DAMAGE.

□ Exhibit-M

Copyright (c) 1998 Red Hat Software

Permission is hereby granted, free of charge, to any person obtaining a copy of this software and associated documentation files (the "Software"), to deal in the Software without restriction, including without limitation the rights to use, copy, modify, merge, publish, distribute, sublicense, and/or sell copies of the Software, and to permit persons to whom the Software is furnished to do so, subject to the following conditions:

The above copyright notice and this permission notice shall be included in all copies or substantial portions of the Software.

THE SOFTWARE IS PROVIDED "AS IS", WITHOUT WARRANTY OF ANY KIND, EXPRESS OR IMPLIED, INCLUDING BUT NOT LIMITED TO THE WARRANTIES OF MERCHANTABILITY, FITNESS FOR A PARTICULAR PURPOSE AND NONINFRINGEMENT. IN NO EVENT SHALL THE X CONSORTIUM BE LIABLE FOR ANY CLAIM, DAMAGES OR OTHER LIABILITY, WHETHER IN AN ACTION OF CONTRACT, TORT OR OTHERWISE, ARISING FROM, OUT OF OR IN CONNECTION WITH THE SOFTWARE OR THE USE OR OTHER DEALINGS IN THE SOFTWARE.

Except as contained in this notice, the name of the X Consortium shall not be used in advertising or otherwise to promote the sale, use or other dealings in this Software without prior written authorization from the X Consortium.

□ Exhibit-N

Copyright (c) 2004-2005 by Internet Systems Consortium, Inc. ("ISC")

Copyright (c) 1995-2003 by Internet Software Consortium
Permission to use, copy, modify, and distribute this software for any purpose with or without fee is hereby granted, provided that the above copyright notice and this permission notice appear in all copies.

THE SOFTWARE IS PROVIDED "AS IS" AND ISC DISCLAIMS ALL WARRANTIES WITH REGARD TO THIS SOFTWARE INCLUDING ALL IMPLIED WARRANTIES OF MERCHANTABILITY AND FITNESS.

IN NO EVENT SHALL ISC BE LIABLE FOR ANY SPECIAL, DIRECT, INDIRECT, OR CONSEQUENTIAL DAMAGES OR ANY DAMAGES WHATSOEVER RESULTING FROM LOSS OF USE, DATA OR PROFITS, WHETHER IN AN ACTION OF CONTRACT, NEGLIGENCE OR OTHER TORTIOUS ACTION, ARISING OUT OF OR IN CONNECTION WITH THE USE OR PERFORMANCE OF THIS SOFTWARE.

Internet Systems Consortium, Inc.

950 Charter Street Redwood City, CA 94063

<info@isc.org> http://www.isc.org/

□ Exhibit-O

OpenBSD: telnet.c.v 1.6 1998/07/27 15:29:29 millert Exp

NetBSD: telnet.c.v 1.7 1996/02/28 21:04:15 thorpej Exp

Copyright (c) 1988, 1990, 1993

The Regents of the University of California. All rights reserved.

Redistribution and use in source and binary forms, with or without modification, are permitted provided that the following conditions are met:

1. Redistributions of source code must retain the above copyright notice, this list of conditions and the following disclaimer.
2. Redistributions in binary form must reproduce the above copyright notice, this list of conditions and the following disclaimer in the documentation and/or other materials provided with the distribution.
3. All advertising materials mentioning features or use of this software must display the following acknowledgement:
This product includes software developed by the University of California, Berkeley and its contributors.
4. Neither the name of the University nor the names of its contributors may be used to endorse or promote products derived from this software without specific prior written permission.

THIS SOFTWARE IS PROVIDED BY THE REGENTS AND CONTRIBUTORS "AS IS" AND ANY EXPRESS OR IMPLIED WARRANTIES, INCLUDING, BUT NOT LIMITED TO, THE IMPLIED WARRANTIES OF MERCHANTABILITY AND FITNESS FOR A PARTICULAR PURPOSE ARE DISCLAIMED. IN NO EVENT SHALL THE REGENTS OR CONTRIBUTORS BE LIABLE FOR ANY DIRECT, INDIRECT, INCIDENTAL, SPECIAL, EXEMPLARY, OR CONSEQUENTIAL DAMAGES (INCLUDING, BUT NOT LIMITED TO, PROCUREMENT OF SUBSTITUTE GOODS OR SERVICES; LOSS OF USE, DATA, OR PROFITS; OR BUSINESS INTERRUPTION) HOWEVER CAUSED AND ON ANY THEORY OF LIABILITY, WHETHER IN CONTRACT, STRICT LIABILITY, OR TORT (INCLUDING NEGLIGENCE OR OTHERWISE) ARISING IN ANY WAY OUT OF THE USE OF THIS SOFTWARE, EVEN IF ADVISED OF THE POSSIBILITY OF SUCH DAMAGE.

□ Exhibit-P

ORIGINAL LICENSE:

This software is

(c) Copyright 1992 by Panagiotis Tsirigotis

The author (Panagiotis Tsirigotis) grants permission to use, copy, and distribute this software and its documentation for any purpose and without fee, provided that the above copyright notice extant in files in this distribution is not removed from files included in any redistribution and that this copyright notice is also included in any redistribution.

Modifications to this software may be distributed, either by distributing the modified software or by distributing patches to the original software, under the following additional terms:

1. The version number will be modified as follows:
 - a. The first 3 components of the version number (i.e. <number>.<number>.<number>) will remain unchanged.
 - b. A new component will be appended to the version number to indicate the modification level. The form of this component is up to the author of the modifications.
2. The author of the modifications will include his/her name by appending it along with the new version number to this file and will be responsible for any wrong behavior of the modified software.

The author makes no representations about the suitability of this software for any purpose. It is provided "as is" without any express or implied warranty.

Modifications:

Version: 2.1.8.7-current

Copyright 1998-2001 by Rob Braun

Sensor Addition

Version: 2.1.8.9pre14a

Copyright 2001 by Steve Grubb

This is an excerpt from an email I recieved from the original author, allowing xinetd as maintained by me, to use the higher version numbers:

I appreciate your maintaining the version string guidelines as specified in the copyright. But I did not mean them to last as long as they did.

So, if you want, you may use any 2.N.* (N >= 3) version string for future xinetd versions that you release. Note that I am excluding the 2.2.* line; using that would only create confusion. Naming the next release 2.3.0 would put to rest the confusion about 2.2.1 and 2.1.8.*.

□ Exhibit-Q

Except where otherwise noted in the source code (e.g. the files hash.c, list.c and the trio files, which are covered by a similar licence but with different Copyright notices) all the files are:

Copyright (C) 1998-2003 Daniel Veillard. All Rights Reserved.

Permission is hereby granted, free of charge, to any person obtaining a copy of this software and associated documentation files (the "Software"), to deal in the Software without restriction, including without limitation the rights to use, copy, modify, merge, publish, distribute, sublicense, and/or sell copies of the Software, and to permit persons to whom the Software is furnished to do so, subject to the following conditions:

The above copyright notice and this permission notice shall be included in all copies or substantial portions of the Software.

THE SOFTWARE IS PROVIDED "AS IS", WITHOUT WARRANTY OF ANY KIND, EXPRESS OR IMPLIED, INCLUDING BUT NOT LIMITED TO THE WARRANTIES OF MERCHANTABILITY, FITNESS FOR A PARTICULAR PURPOSE AND NONINFRINGEMENT. IN NO EVENT SHALL THE DANIEL VEILLARD BE LIABLE FOR ANY CLAIM, DAMAGES OR OTHER LIABILITY, WHETHER IN AN ACTION OF CONTRACT, TORT OR OTHERWISE, ARISING FROM, OUT OF OR IN CONNECTION WITH THE SOFTWARE OR THE USE OR OTHER DEALINGS IN THE SOFTWARE.

Except as contained in this notice, the name of Daniel Veillard shall not be used in advertising or otherwise to promote the sale, use or other dealings in this Software without prior written authorization from him.

□ Exhibit-R LICENSE ISSUES

The OpenSSL toolkit stays under a dual license, i.e. both the conditions of the OpenSSL License and the original SSLeay license apply to the toolkit. See below for the actual license texts. Actually both licenses are BSD-style Open Source licenses. In case of any license issues related to OpenSSL please contact openssl-core@openssl.org.

OpenSSL License

Copyright (c) 1998-2004 The OpenSSL Project. All rights reserved.

Redistribution and use in source and binary forms, with or without modification, are permitted provided that the following conditions are met:

1. Redistributions of source code must retain the above copyright notice, this list of conditions and the following disclaimer.
2. Redistributions in binary form must reproduce the above copyright notice, this list of conditions and the following disclaimer in the documentation and/or other materials provided with the distribution.
3. All advertising materials mentioning features or use of this software must display the following acknowledgment:
"This product includes software developed by the OpenSSL Project for use in the OpenSSL Toolkit. (<http://www.openssl.org/>)"
4. The names "OpenSSL Toolkit" and "OpenSSL Project" must not be used to endorse or promote products derived from this software without prior written permission. For written permission, please contact openssl-core@openssl.org.
5. Products derived from this software may not be called "OpenSSL" nor may "OpenSSL" appear in their names without prior written permission of the OpenSSL Project.
6. Redistributions of any form whatsoever must retain the following acknowledgment:
"This product includes software developed by the OpenSSL Project for use in the OpenSSL Toolkit (<http://www.openssl.org/>)"

THIS SOFTWARE IS PROVIDED BY THE OpenSSL PROJECT "AS IS" AND ANY EXPRESSED OR IMPLIED WARRANTIES, INCLUDING, BUT NOT LIMITED TO, THE IMPLIED WARRANTIES OF MERCHANTABILITY AND FITNESS FOR A PARTICULAR PURPOSE ARE DISCLAIMED.

IN NO EVENT SHALL THE OpenSSL PROJECT OR ITS CONTRIBUTORS BE LIABLE FOR ANY DIRECT, INDIRECT, INCIDENTAL, SPECIAL, EXEMPLARY, OR CONSEQUENTIAL DAMAGES (INCLUDING, BUT NOT LIMITED TO, PROCUREMENT OF SUBSTITUTE GOODS OR SERVICES; LOSS OF USE, DATA, OR PROFITS; OR BUSINESS INTERRUPTION) HOWEVER CAUSED AND ON ANY THEORY OF LIABILITY, WHETHER IN CONTRACT, STRICT LIABILITY, OR TORT (INCLUDING NEGLIGENCE OR OTHERWISE) ARISING IN ANY WAY OUT OF THE USE OF THIS SOFTWARE, EVEN IF ADVISED OF THE POSSIBILITY OF SUCH DAMAGE.

This product includes cryptographic software written by Eric Young (ey@cryptsoft.com). This product includes software written by Tim Hudson (tjh@cryptsoft.com).

Original SSLeay License

Copyright (C) 1995-1998 Eric Young (ey@cryptsoft.com)

All rights reserved.

This package is an SSL implementation written by Eric Young (ey@cryptsoft.com).

The implementation was written so as to conform with Netscapes SSL.

This library is free for commercial and non-commercial use as long as the following conditions are adhered to. The following conditions apply to all code found in this distribution, be it the RC4, RSA, lhash, DES, etc., code; not just the SSL code. The SSL documentation included with this distribution is covered by the same copyright terms except that the holder is Tim Hudson (tjh@cryptsoft.com). Copyright remains Eric Young's, and as such any Copyright notices in the code are not to be removed.

If this package is used in a product, Eric Young should be given attribution as the author of the parts of the library used.

This can be in the form of a textual message at program startup or in documentation (online or textual) provided with the package.

Redistribution and use in source and binary forms, with or without modification, are permitted provided that the following conditions are met:

1. Redistributions of source code must retain the copyright notice, this list of conditions and the following disclaimer.
2. Redistributions in binary form must reproduce the above copyright notice, this list of conditions and the following disclaimer in the documentation and/or other materials provided with the distribution.
3. All advertising materials mentioning features or use of this software must display the following acknowledgment:
"This product includes cryptographic software written by Eric Young (ey@cryptsoft.com)"
The word 'cryptographic' can be left out if the routines from the library being used are not cryptographic related :-).
4. If you include any Windows specific code (or a derivative thereof) from the apps directory (application code) you must include an acknowledgement:
"This product includes software written by Tim Hudson (tjh@cryptsoft.com)"

THIS SOFTWARE IS PROVIDED BY ERIC YOUNG "AS IS" AND ANY EXPRESS OR IMPLIED WARRANTIES, INCLUDING, BUT NOT LIMITED TO, THE IMPLIED WARRANTIES OF MERCHANTABILITY AND FITNESS FOR A PARTICULAR PURPOSE ARE DISCLAIMED. IN NO EVENT SHALL THE AUTHOR OR CONTRIBUTORS BE LIABLE FOR ANY DIRECT, INDIRECT, INCIDENTAL, SPECIAL, EXEMPLARY, OR CONSEQUENTIAL DAMAGES (INCLUDING, BUT NOT LIMITED TO, PROCUREMENT OF SUBSTITUTE GOODS OR SERVICES; LOSS OF USE, DATA, OR PROFITS; OR BUSINESS INTERRUPTION) HOWEVER CAUSED AND ON ANY THEORY OF LIABILITY, WHETHER IN CONTRACT, STRICT LIABILITY, OR TORT (INCLUDING NEGLIGENCE OR OTHERWISE) ARISING IN ANY WAY OUT OF THE USE OF THIS SOFTWARE, EVEN IF ADVISED OF THE POSSIBILITY OF SUCH DAMAGE.

The licence and distribution terms for any publically available version or derivative of this code cannot be changed. i.e. this code cannot simply be copied and put under another distribution licence [including the GNU Public Licence.]

□ Exhibit-S

Copyright (c) 1998-2001,2002 Free Software Foundation, Inc.

Permission is hereby granted, free of charge, to any person obtaining a copy of this software and associated documentation files (the "Software"), to deal in the Software without restriction, including without limitation the rights to use, copy, modify, merge, publish, distribute, distribute with modifications, sublicense, and/or sell copies of the Software, and to permit persons to whom the Software is furnished to do so, subject to the following conditions: The above copyright notice and this permission notice shall be included in all copies or substantial portions of the Software.

THE SOFTWARE IS PROVIDED "AS IS", WITHOUT WARRANTY OF ANY KIND, EXPRESS OR IMPLIED, INCLUDING BUT NOT LIMITED TO THE WARRANTIES OF MERCHANTABILITY, FITNESS FOR A PARTICULAR PURPOSE AND NONINFRINGEMENT.

IN NO EVENT SHALL THE ABOVE COPYRIGHT HOLDERS BE LIABLE FOR ANY CLAIM, DAMAGES OR OTHER LIABILITY, WHETHER IN AN ACTION OF CONTRACT, TORT OR OTHERWISE, ARISING FROM, OUT OF OR IN CONNECTION WITH THE SOFTWARE OR THE USE OR OTHER DEALINGS IN THE SOFTWARE.

Except as contained in this notice, the name(s) of the above copyright holders shall not be used in advertising or otherwise to promote the sale, use or other dealings in this Software without prior written authorization.

□ Exhibit-T

Copyright (c) 1990 The Regents of the University of California.

All rights reserved.

Redistribution and use in source and binary forms, with or without modification, are permitted provided that the following conditions are met:

1. Redistributions of source code must retain the above copyright notice, this list of conditions and the following disclaimer.
2. Redistributions in binary form must reproduce the above copyright notice, this list of conditions and the following disclaimer in the documentation and/or other materials provided with the distribution.
3. All advertising materials mentioning features or use of this software must display the following acknowledgement:
This product includes software developed by the University of California, Berkeley and its contributors.
4. Neither the name of the University nor the names of its contributors may be used to endorse or promote products derived from this software without specific prior written permission.

THIS SOFTWARE IS PROVIDED BY THE REGENTS AND CONTRIBUTORS "AS IS" AND ANY EXPRESS OR IMPLIED WARRANTIES, INCLUDING, BUT NOT LIMITED TO, THE IMPLIED WARRANTIES OF MERCHANTABILITY AND FITNESS FOR A PARTICULAR PURPOSE ARE DISCLAIMED. IN NO EVENT SHALL THE REGENTS OR CONTRIBUTORS BE LIABLE FOR ANY DIRECT, INDIRECT, INCIDENTAL, SPECIAL, EXEMPLARY, OR CONSEQUENTIAL DAMAGES (INCLUDING, BUT NOT LIMITED TO, PROCUREMENT OF SUBSTITUTE GOODS OR SERVICES; LOSS OF USE, DATA, OR PROFITS; OR BUSINESS INTERRUPTION) HOWEVER CAUSED AND ON ANY THEORY OF LIABILITY, WHETHER IN CONTRACT, STRICT LIABILITY, OR TORT (INCLUDING NEGLIGENCE OR OTHERWISE) ARISING IN ANY WAY OUT OF THE USE OF THIS SOFTWARE, EVEN IF ADVISED OF THE POSSIBILITY OF SUCH DAMAGE.

Copyright (C) 1985-2005 by the Massachusetts Institute of Technology.

All rights reserved.

Export of this software from the United States of America may require a specific license from the United States Government. It is the responsibility of any person or organization contemplating export to obtain such a license before exporting.

WITHIN THAT CONSTRAINT, permission to use, copy, modify, and distribute this software and its documentation for any purpose and without fee is hereby granted, provided that the above copyright notice appear in all copies and that both that copyright notice and this permission notice appear in supporting documentation, and that the name of M.I.T. not be used in advertising or publicity pertaining to distribution of the software without specific, written prior permission. Furthermore if you modify this software you must label your software as modified software and not distribute it in such a fashion that it might be confused with the original MIT software.

M.I.T. makes no representations about the suitability of this software for any purpose. It is provided "as is" without express or implied warranty.

THIS SOFTWARE IS PROVIDED "AS IS" AND WITHOUT ANY EXPRESS OR IMPLIED WARRANTIES, INCLUDING, WITHOUT LIMITATION, THE IMPLIED WARRANTIES OF MERCHANTABILITY AND FITNESS FOR A PARTICULAR PURPOSE.

Individual source code files are copyright MIT, Cygnus Support, OpenVision, Oracle, Sun Soft, FundsXpress, and others.

Project Athena, Athena, Athena MUSE, Discuss, Hesiod, Kerberos, Moira, and Zephyr are trademarks of the Massachusetts Institute of Technology (MIT). No commercial use of these trademarks may be made without prior written permission of MIT.

“Commercial use” means use of a name in a product or other for-profit manner. It does NOT prevent a commercial firm from referring to the MIT trademarks in order to convey information (although in doing so, recognition of their trademark status should be given).

The following copyright and permission notice applies to the OpenVision Kerberos Administration system located in `kadmin/create`, `kadmin/dbutil`, `kadmin/passwd`, `kadmin/server`, `lib/kadm5`, and portions of `lib/rpc`:

Copyright, OpenVision Technologies, Inc., 1996, All Rights Reserved

WARNING: Retrieving the OpenVision Kerberos Administration system source code, as described below, indicates your acceptance of the following terms. If you do not agree to the following terms, do not retrieve the OpenVision Kerberos administration system.

You may freely use and distribute the Source Code and Object Code compiled from it, with or without modification, but this Source Code is provided to you “AS IS” EXCLUSIVE OF ANY WARRANTY, INCLUDING, WITHOUT LIMITATION, ANY WARRANTIES OF MERCHANTABILITY OR FITNESS FOR A PARTICULAR PURPOSE, OR ANY OTHER WARRANTY, WHETHER EXPRESS OR IMPLIED. IN NO EVENT WILL OPENVISION HAVE ANY LIABILITY FOR ANY LOST PROFITS, LOSS OF DATA OR COSTS OF PROCUREMENT OF SUBSTITUTE GOODS OR SERVICES, OR FOR ANY SPECIAL, INDIRECT, OR CONSEQUENTIAL DAMAGES ARISING OUT OF THIS AGREEMENT, INCLUDING, WITHOUT LIMITATION, THOSE RESULTING FROM THE USE OF THE SOURCE CODE, OR THE FAILURE OF THE SOURCE CODE TO PERFORM, OR FOR ANY OTHER REASON.

OpenVision retains all copyrights in the donated Source Code. OpenVision also retains copyright to derivative works of the Source Code, whether created by OpenVision or by a third party. The OpenVision copyright notice must be preserved if derivative works are made based on the donated Source Code.

OpenVision Technologies, Inc. has donated this Kerberos Administration system to MIT for inclusion in the standard Kerberos 5 distribution. This donation underscores our commitment to continuing Kerberos technology development and our gratitude for the valuable work which has been performed by MIT and the Kerberos community.

Portions contributed by Matt Crawford <crawdad@fnal.gov> were work performed at Fermi National Accelerator Laboratory, which is operated by Universities Research Association, Inc., under contract DE-AC02-76CHO3000 with the U.S. Department of Energy.

The implementation of the Yarrow pseudo-random number generator in `src/lib/crypto/yarrow` has the following copyright:

Copyright 2000 by Zero-Knowledge Systems, Inc.

Permission to use, copy, modify, distribute, and sell this software and its documentation for any purpose is hereby granted without fee, provided that the above copyright notice appear in all copies and that both that copyright notice and this permission notice appear in supporting documentation, and that the name of Zero-Knowledge Systems, Inc. not be used in advertising or publicity pertaining to distribution of the software without specific, written prior permission. Zero-Knowledge Systems, Inc. makes no representations about the suitability of this software for any purpose. It is provided “as is” without express or implied warranty.

ZERO-KNOWLEDGE SYSTEMS, INC. DISCLAIMS ALL WARRANTIES WITH REGARD TO THIS SOFTWARE, INCLUDING ALL IMPLIED WARRANTIES OF MERCHANTABILITY AND FITNESS, IN NO EVENT SHALL ZERO-KNOWLEDGE SYSTEMS, INC. BE LIABLE FOR ANY SPECIAL, INDIRECT OR CONSEQUENTIAL DAMAGES OR ANY DAMAGES WHATSOEVER RESULTING FROM LOSS OF USE, DATA OR PROFITS, WHETHER IN AN ACTION OF CONTRACT, NEGLIGENCE OR OTHER TORTUOUS ACTION, ARISING OUT OF OR IN CONNECTION WITH THE USE OR PERFORMANCE OF THIS SOFTWARE.

The implementation of the AES encryption algorithm in `src/lib/crypto/aes` has the following copyright:

Copyright (c) 2001, Dr Brian Gladman <brg@gladman.uk.net>, Worcester, UK.

All rights reserved.

LICENSE TERMS

The free distribution and use of this software in both source and binary form is allowed (with or without changes) provided that:

1. distributions of this source code include the above copyright notice, this list of conditions and the following disclaimer;
2. distributions in binary form include the above copyright notice, this list of conditions and the following disclaimer in the documentation and/or other associated materials;
3. the copyright holder’s name is not used to endorse products built using this software without specific written permission.

DISCLAIMER

This software is provided “as is” with no explicit or implied warranties in respect of any properties, including, but not limited to, correctness and fitness for purpose.

The implementation of the RPCSEC_GSS authentication flavor in `src/lib/rpc` has the following copyright:

Copyright (c) 2000 The Regents of the University of Michigan.

All rights reserved.

Copyright (c) 2000 Dug Song <dugsong@UMICH.EDU>.

All rights reserved, all wrongs reversed.

Redistribution and use in source and binary forms, with or without modification, are permitted provided that the following conditions are met:

1. Redistributions of source code must retain the above copyright notice, this list of conditions and the following disclaimer.
2. Redistributions in binary form must reproduce the above copyright notice, this list of conditions and the following disclaimer in the documentation and/or other materials provided with the distribution.

3. Neither the name of the University nor the names of its contributors may be used to endorse or promote products derived from this software without specific prior written permission.

THIS SOFTWARE IS PROVIDED “AS IS” AND ANY EXPRESS OR IMPLIED WARRANTIES, INCLUDING, BUT NOT LIMITED TO, THE IMPLIED WARRANTIES OF MERCHANTABILITY AND FITNESS FOR A PARTICULAR PURPOSE ARE DISCLAIMED. IN NO EVENT SHALL THE REGENTS OR CONTRIBUTORS BE LIABLE FOR ANY DIRECT, INDIRECT, INCIDENTAL, SPECIAL, EXEMPLARY, OR CONSEQUENTIAL DAMAGES (INCLUDING, BUT NOT LIMITED TO, PROCUREMENT OF SUBSTITUTE GOODS OR SERVICES; LOSS OF USE, DATA, OR PROFITS; OR BUSINESS INTERRUPTION) HOWEVER CAUSED AND ON ANY THEORY OF LIABILITY, WHETHER IN CONTRACT, STRICT LIABILITY, OR TORT (INCLUDING NEGLIGENCE OR OTHERWISE) ARISING IN ANY WAY OUT OF THE USE OF THIS SOFTWARE, EVEN IF ADVISED OF THE POSSIBILITY OF SUCH DAMAGE.

Acknowledgments

Appreciation Time!!!! There are far too many people to try to thank them all; many people have contributed to the development of Kerberos V5. This is only a partial listing....

Thanks to Kevin Coffman and the CITI group at the University of Michigan for providing patches for implementing RPCSEC_GSS authentication in the RPC library.

Thanks to Derrick Schommer for reporting multiple memory leaks.

Thanks to Quannah Gibson-Mount of Stanford University for helping exercise the thread support code.

Thanks to Michael Tautschnig for reporting the heap buffer overflow in the password history mechanism. [MITKRB5-SA-2004-004]

Thanks to Wyllys Ingersoll for finding a buffer-size problem in the RPCSEC_GSS implementation.

Thanks to the members of the Kerberos V5 development team at MIT, both past and present: Danilo Almeida, Jeffrey Altman, Jay Berkenbilt, Richard Basch, Mitch Berger, John Carr, Don Davis, Alexandra Ellwood, Nancy Gilman, Matt Hancher, Sam Hartman, Paul Hill, Marc Horowitz, Eva Jacobus, Miroslav Jurisic, Barry Jaspan, Geoffrey King, John Kohl, Peter Litwack, Scott McGuire, Kevin Mitchell, Cliff Neuman, Paul Park, Ezra Peisach, Chris Provenzano, Ken Raeburn, Jon Rochlis, Jeff Schiller, Jen Selby, Brad Thompson, Harry Tsai, Ted Ts’o, Marshall Vale, Tom Yu.

Very special thanks go to Marshall Vale, our departing team leader.

Over the past few years, Marshall has been extremely valuable to us as mentor, advisor, manager, and friend. Marshall’s devotion as a champion of Kerberos has helped our team immensely through many trials and hardships. We will miss him tremendously, and we wish him the best in his future endeavors.

Exhibit-U

Copyright (c) 1989 The Regents of the University of California.

All rights reserved.

This code is derived from software contributed to Berkeley by Mike Muuss.

Redistribution and use in source and binary forms, with or without modification, are permitted provided that the following conditions are met:

1. Redistributions of source code must retain the above copyright notice, this list of conditions and the following disclaimer.
2. Redistributions in binary form must reproduce the above copyright notice, this list of conditions and the following disclaimer in the documentation and/or other materials provided with the distribution.
3. All advertising materials mentioning features or use of this software must display the following acknowledgement:
This product includes software developed by the University of California, Berkeley and its contributors.
4. Neither the name of the University nor the names of its contributors may be used to endorse or promote products derived from this software without specific prior written permission.

THIS SOFTWARE IS PROVIDED BY THE REGENTS AND CONTRIBUTORS “AS IS” AND ANY EXPRESS OR IMPLIED WARRANTIES, INCLUDING, BUT NOT LIMITED TO, THE IMPLIED WARRANTIES OF MERCHANTABILITY AND FITNESS FOR A PARTICULAR PURPOSE ARE DISCLAIMED. IN NO EVENT SHALL THE REGENTS OR CONTRIBUTORS BE LIABLE FOR ANY DIRECT, INDIRECT, INCIDENTAL, SPECIAL, EXEMPLARY, OR CONSEQUENTIAL DAMAGES (INCLUDING, BUT NOT LIMITED TO, PROCUREMENT OF SUBSTITUTE GOODS OR SERVICES; LOSS OF USE, DATA, OR PROFITS; OR BUSINESS INTERRUPTION) HOWEVER CAUSED AND ON ANY THEORY OF LIABILITY, WHETHER IN CONTRACT, STRICT LIABILITY, OR TORT (INCLUDING NEGLIGENCE OR OTHERWISE) ARISING IN ANY WAY OUT OF THE USE OF THIS SOFTWARE, EVEN IF ADVISED OF THE POSSIBILITY OF SUCH DAMAGE.

License Information for the Software Used in the Unit

About GPL (GNU-General Public License), LGPL (GNU Lesser General Public License) License

This product uses GPL/LGPL software and software made by other companies.

After you purchase this product, you may procure, modify or distribute the source code of the GPL/LGPL software that is used in the product.

DENON provides the source code based on the GPL and LGPL licenses at the actual cost upon your request to our customer service center. However, note that we make no guarantees concerning the source code. Please also understand that we do not offer support for the contents of the source code.



DENON

www.denon.com

D&M Holdings Inc.
Printed in China 5411 10566 007D

