

M I K O

IBUKI Air Enhancer User Manual

MODEL NO: MA-01

SHOPMIKO.COM

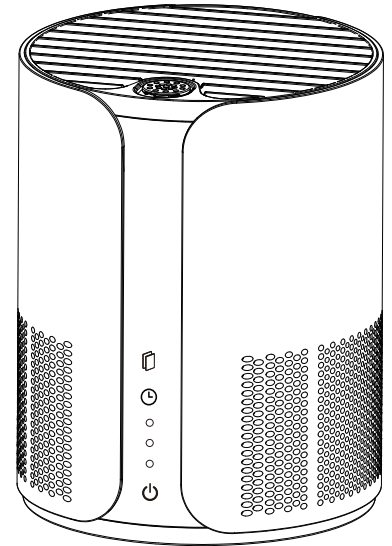

IBUKI Air Enhancer

Packing List

No	Item	Model No.	Unit	Q'ty	Remarks
1	Device		PC	1	
2	Manual		PC	1	
3	Aroma Cotton		PC	3	
4	Filter		PC	1	Pls remove the plastic bag before use.

Contents

Safety Precautions	1
Component Description.....	2
Preparation Before Use	3
Product Troubleshooting	5
Power cord Considerations	6
Maintenance.....	7
Replace Filter.....	8

Safety Precautions

Thank you for using our desktop air purifier. In order to better read this manual and use the desktop air purifier, here is an explanation of the glyphs that appear in the manual:



Anything with this mark must be absolutely prohibited, otherwise it may cause damage to the machine or endanger the safety of the user.



For the contents bearing the logo, the safety of the product and the personal safety of the user must be strictly in accordance with the contents of the warning.



Do not use solvent-based desktop air purifiers such as alcohol or thinner.



Do not place the desktop air purifier in a place where flammable gas is easily leaked to prevent a gas leak and cause a fire. Do not use in a flammable, explosive or corrosive atmosphere.



Do not pull on the power cord while moving or storing.



Do not touch the power cord plug with wet hands.



Please supervise and guide young children to avoid direct operation or contact with desktop air purifiers.



Do not put your fingers or metal objects in the gaps between the air inlet and the air outlet. Do not allow volatile substances or combustible materials, such as cigarettes, to float into the unit.



There is an electric control board on the base, keep away from water.



The air intake is located on the base of the unit. The air outlet is at the top of the unit. Please do not block or obstruct the air intake or outlet.



Do not use the power cord or plug if it is damaged. Do not touch the power cord with wet hands.



Regularly check and replace the filter. If the filter is blocked, the air will be ineffective and the power consumption will increase, causing malfunction.



When not in use for a long time, please turn off the power and avoid exposure to sunlight.



When moving or performing maintenance on the air purifier, be sure to stop the operation and unplug the power cord.



If the machine fails, stop using it and turn off the power. First, follow the instructions for troubleshooting. If it can't be corrected, please contact the after-sales personnel for inspection.

Components Description

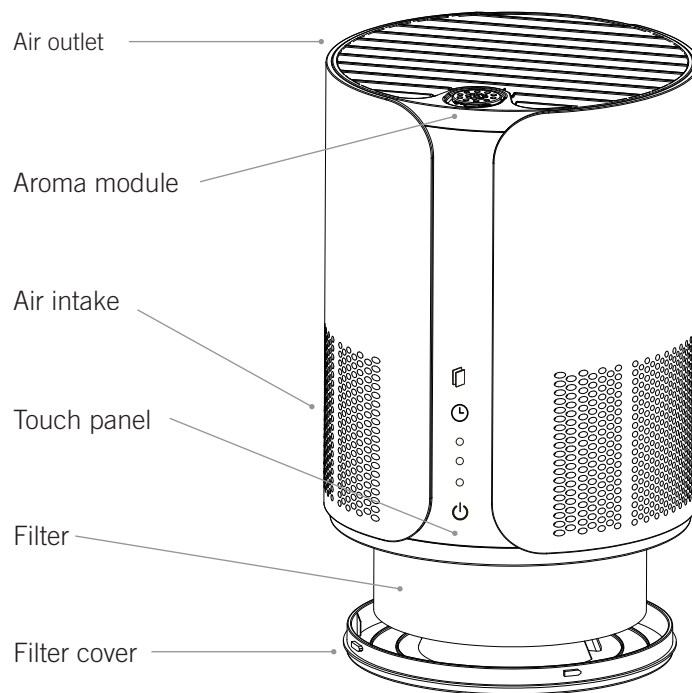

Preparation Before Use

Aromatherapy box / filter installation (make sure to do before the power plug is plugged into the socket)

- Disassemble the filter cover at the bottom of the air intake. Place it on the bottom of the filter cover with your hand, press firmly with a little force, turn left in the direction indicated by the arrow to remove the bottom cover. (Automatically cut off the power after opening the bottom filter cover)

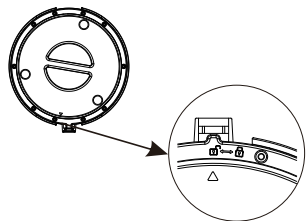

- Install the filter.
 - Install the filter that has removed the plastic bag into the machine.
 - After closing the filter cover, turn it to the right to lock it.

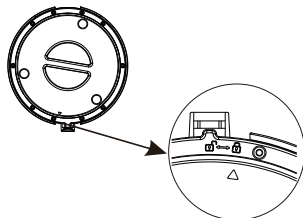

- Remove the filter containing the PE bag. The filter has been placed in the purifier. Grab the bag of the filter by hand and take out the filter.

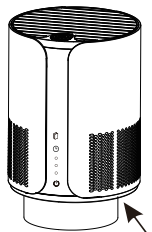

- Take the filter out of the plastic bag.

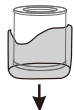



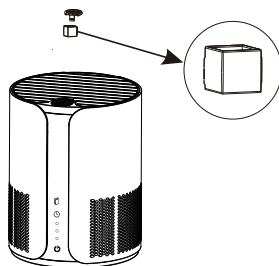



- Install the aromatherapy box. Aromatherapy box is already installed in this unit. If you need to add or replace essential oil, please take it out. Then in the following order, first put the aromatherapy box into the machine. (Please pay attention to the installation direction)



Touch button operation + display instructions

When the power is turned on for the first time, the buzzer will beep and all the display buttons will light up and the indicator will go out

	Filter reset switch
	Timer switch
	High speed indicator
	Medium speed indicator
	Low speed indicator
	Power

Timer

1. When the power is on, press "Timer" button, the Timer indicator light is twinkling to show the machine will be off in 4 hours. Press "Timer" button, the Timer indicator light is on to show the machine will be off in 8 hours. Press "Timer" button, the Timer indicator light is off to show that timer is canceled.

Filter reset

When the purifying filter replacement reminder light is on, please turn off the power and replace the purifier filter. After the replacement is completed, press and hold the "Reset" button for 2 seconds, the buzzer will sound once, the replacement reminder will reset, and the reminder light will go out.

Power button

In the standby mode, tap the "Power" button and the machine enters the power on state.

After the power is turned on, the wind speed defaults to low-level operation, and the corresponding function indicator lights.

In the power on state, press and hold the "Power" button for 2 seconds to enter the standby mode.

Wind speed gear button

In the power-on state, the default wind speed is low. If you need to switch the wind speed, you can touch the "Power" button.

Each time the "Power" is tapped, the wind speed gear is continuously selected by low speed, medium speed, high speed and low speed.

Aromatherapy module

After removing the aromatherapy cover, the aromatherapy block can be taken out and the essential oil can be dripped, and the essential oil will be evenly distributed with the air flow.

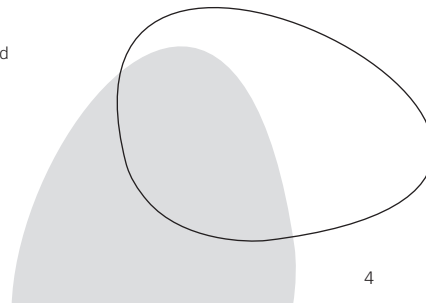

Product Troubleshooting

Fault	Checklist	Possible Solution
Machine not working	The power is not on	Power it on
	Power plug is loose or not plugged in	Pull out the plug and plug in again
Peculiar smell from air outlet	The filter has absorbed too much odor or dust	Change the filter
Bad performance	Indoor air is too dry	Increase indoor humidity appropriately
	There's not enough space around machine	Change placement, Remove obstacles
No air is blowing out	There is something blocking the outlet or intake or filter's packing bag is not removed	Clear space around the unit, and remove the filter's packing bag

Power cord Considerations



- Do not use power beyond the rated voltage(110V 60Hz) (Otherwise it may cause fire and electric shock and so on.)
- Do not process the power line arbitrarily, bend the power line forcibly, draw, twist and bundle up the power line.
- Do not let the power line approach high temperature objects.(If the power line is worn, fire and electric shock may occur.)
- Do not put heavy objects on it or press. (Overloading may cause fire and/or electric shock.)
- Do not use when the power line or power plug is worn and loose. (Otherwise it may cause fire, electric shock, short circuit and so on.)
- Do not insert and pull the power line with wet hands. (Otherwise it may cause electric shock and so on.)
- Do not change the power line without permission. When necessary, please contact our consumer service center.
- Clean regularly the dust on the power plug and socket.(Too much dust and moisture may cause defective insulation. Then fire and electric shock may occur.)



Warning

Non-authorized personnel should not dismantle the machine without permission in case of electric shock danger. Pls pull out the power plug when changing or cleaning the filter set. In case of failure, please follow the troubleshooting method in the manual. If failier not resolved, please contact our support centre.

Maintenance

For best results and long unit life, please keep regular preventative maintenance.

During maintenance, checked or moved, please stop running the unit and pull the power plug. Pls do not use wet hand to plug in or pull out the power plug. Otherwise it may cause electric shock and injury.

Main body – Once a month

Pls use soft cloth to clean the surface of air purifier's body. If smudge is serious, pls use warm wet cloth or neutral detergent to clean, then wipe with dry cloth

Attention

- Do not use too hot water (higher than 40°C).
- It may cause fade deformation.
- Do not use insecticide or other chemical detergent. Never wash the air purifier's body with water.

Filter

There's one filter inside the machine which can not be washed. Change the filter every three months. New filter could be purchased from shopmiko.

Long idle time

- 1 Pull out the power cord.
- 2 Cover the machine with a plastic bag and place it in a dry place for safekeeping
- 3 Do not store the product upside down which may lead to product failure.

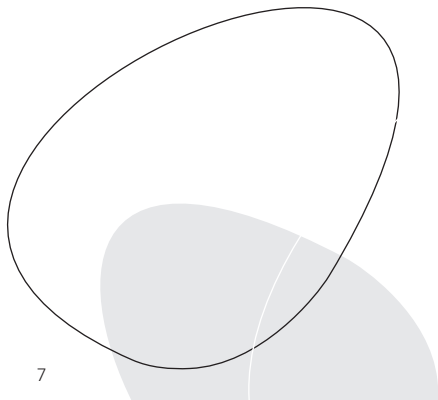

Replace filter



The machine should be unplugged on the following maintenance steps.

1. Remove the PE bag

When using the air purifier for the first time, please open the bottom cap of air purifier to take out the filter and make sure to remove the plastic bag from the filter. Otherwise the product will not be able to purify the air normally.

- * Keep the plastic bag away from infants to avoid the accident.

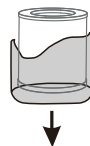

2. Clean or change the filter

- 1) Take the filter out from air purifier as shown in figure A.
- 2) Remove the packing bag of new filter as shown in figure B.
- 3) Put the new filter inside the machine and rearrange the bottom cap as shown in figure C.
- 4) Plug in the power cord and turn on the machine. Long pressing the FILTER RESET button for 2s. The filter reset indicator light will be off which means it's reset successfully.

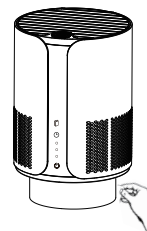

Figure A

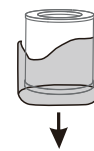

Figure B

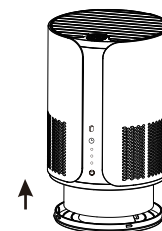

Figure C