



Lexmark™

CX730, CX735, CX737, XC4342, XC4352 MFPs

User's Guide

July 2024

www.lexmark.com

Machine type:

7530

Models:

236, 239, 678, 679, 878



Contents

- Safety information..... 6**
 - Conventions..... 6
 - Product statements..... 6

- Learn about the printer..... 9**
 - Finding information about the printer.....9
 - Finding the printer serial number.....10
 - Printer configurations..... 10
 - Using the control panel.....11
 - Understanding the status of the indicator light..... 12
 - Selecting paper.....12

- Set up, install, and configure..... 20**
 - Selecting a location for the printer..... 20
 - Attaching cables..... 21
 - Setting up and using the home screen applications..... 22
 - Setting up and using the accessibility features.....28
 - Setting up the printer to fax..... 33
 - Configuring the e-mail SMTP settings..... 40
 - Loading paper and specialty media..... 48
 - Installing and updating software, drivers, and firmware..... 54
 - Installing hardware options..... 58
 - Networking..... 97
 - Setting up serial printing (Windows only)..... 100

- Secure the printer..... 101**
 - Locating the security slot..... 101
 - Erasing printer memory..... 101
 - Erasing printer storage drive..... 101
 - Restoring factory default settings..... 102
 - Statement of Volatility..... 102

- Print..... 103**
 - Printing from a computer..... 103
 - Printing from a mobile device..... 103



Printing from a flash drive.....105

Supported flash drives and file types.....106

Configuring confidential jobs..... 106

Printing confidential and other held jobs.....107

Printing a font sample list..... 108

Printing a directory list.....108

Placing separator sheets between copies.....108

Canceling a print job.....108

Adjusting toner darkness.....108

Copy..... 109

Using the automatic document feeder and scanner glass.....109

Making copies..... 109

Copying photos.....109

Copying on letterhead.....110

Copying on both sides of the paper..... 110

Reducing or enlarging copies..... 110

Collating copies.....110

Placing separator sheets between copies.....110

Copying multiple pages onto a single sheet..... 111

Copying cards..... 111

Creating a copy shortcut.....111

E-mail..... 112

Using the automatic document feeder and scanner glass..... 112

Sending an e-mail..... 112

Creating an e-mail shortcut..... 112

Fax..... 113

Using the automatic document feeder and scanner glass..... 113

Sending a fax..... 113

Scheduling a fax..... 114

Creating a fax destination shortcut..... 114

Changing the fax resolution..... 114

Adjusting the fax darkness..... 114

Printing a fax log..... 115

Blocking junk faxes.....115

Holding faxes..... 115
 Forwarding a fax..... 115

Scan..... 117

Using the automatic document feeder and scanner glass..... 117
 Scanning to a computer..... 117
 Scanning to an FTP server..... 118
 Creating an FTP shortcut..... 118
 Scanning to a network folder..... 119
 Creating a network folder shortcut..... 119
 Scanning to a flash drive..... 120

Use printer menus..... 121

Menu map..... 121
 Device..... 122
 Print..... 138
 Paper..... 146
 Copy..... 149
 Fax..... 152
 E-mail..... 168
 FTP..... 174
 USB Drive..... 178
 Network/Ports..... 183
 Security..... 196
 Cloud Services..... 204
 Reports..... 204
 Troubleshooting..... 206
 Printing the Menu Settings Page..... 206

Maintain the printer..... 207

Checking the status of parts and supplies..... 207
 Configuring supply notifications..... 207
 Setting up e-mail alerts..... 207
 Viewing reports..... 208
 Ordering parts and supplies..... 208
 Replacing parts and supplies..... 211
 Cleaning printer parts..... 249



Saving energy and paper..... 261
 Moving the printer to another location..... 261
 Shipping the printer..... 262

Troubleshoot a problem..... 263

Print quality problems.....263
 Printer error codes.....264
 Printing problems..... 273
 The printer is not responding..... 304
 Unable to read flash drive..... 305
 Enabling the USB port..... 306
 Clearing jams..... 306
 Network connection problems..... 316
 Hardware options problems..... 318
 Issues with supplies..... 321
 Paper feed problems..... 323
 E-mailing problems.....325
 Faxing problems.....326
 Scanning problems.....332
 Color quality problems..... 339
 Contacting customer support..... 341

Recycle and dispose..... 342

Recycling Lexmark products..... 342
 Recycling Lexmark packaging..... 342

Notices..... 343

Index.....359



Safety information

Conventions





Note: A *note* identifies information that could help you.

Warning: A *warning* identifies something that could damage the product hardware or software.







WARNING (in full capitals): A *WARNING* indicates a risk of death or serious injury if not avoided.









CAUTION: A *caution* indicates a potentially hazardous situation that could injure you.







Different types of caution statements include:

-  **CAUTION—POTENTIAL INJURY:** Indicates a risk of injury.
-  **CAUTION—SHOCK HAZARD:** Indicates a risk of electrical shock.
-  **CAUTION—HOT SURFACE:** Indicates a risk of burn if touched.
-  **CAUTION—TIPPING HAZARD:** Indicates a crush hazard.
-  **CAUTION—PINCH HAZARD:** Indicates a risk of being caught between moving parts.

Product statements

-  **CAUTION—POTENTIAL INJURY:** To avoid the risk of fire or electrical shock, connect the power cord to an appropriately rated and properly grounded electrical outlet that is near the product and easily accessible.
-  **CAUTION—POTENTIAL INJURY:** To avoid the risk of fire or electrical shock, use only the power cord provided with this product or the manufacturer's authorized replacement.
-  **CAUTION—POTENTIAL INJURY:** Do not use this product with extension cords, multioutlet power strips, multioutlet extenders, or UPS devices. The power capacity of these types of accessories can be easily overloaded by a laser printer and may result in a risk of fire, property damage, or poor printer performance.
-  **CAUTION—POTENTIAL INJURY:** Only a Lexmark Inline Surge Protector that is properly connected between the printer and the power cord provided with the printer may be used with this product. The use of non-Lexmark surge protection devices may result in a risk of fire, property damage, or poor printer performance.
-  **CAUTION—POTENTIAL INJURY:** To reduce the risk of fire, use only a 26 AWG or larger telecommunications (RJ-11) cord when connecting this product to the public switched telephone network. For users in Australia, the cord must be approved by the Australian Communications and Media Authority.
-  **CAUTION—SHOCK HAZARD:** To avoid the risk of electrical shock, do not place or use this product near water or wet locations.

-  **CAUTION—SHOCK HAZARD:** To avoid the risk of electrical shock, do not set up this product or make any electrical or cabling connections, such as the power cord, fax feature, or telephone, during a lightning storm.
-  **CAUTION—POTENTIAL INJURY:** Do not cut, twist, bind, crush, or place heavy objects on the power cord. Do not subject the power cord to abrasion or stress. Do not pinch the power cord between objects such as furniture and walls. If any of these things happen, a risk of fire or electrical shock results. Inspect the power cord regularly for signs of such problems. Remove the power cord from the electrical outlet before inspecting it.
-  **CAUTION—SHOCK HAZARD:** To avoid the risk of electrical shock, make sure that all external connections (such as Ethernet and telephone system connections) are properly installed in their marked plug-in ports.
-  **CAUTION—SHOCK HAZARD:** To avoid the risk of electrical shock, if you are accessing the controller board or installing optional hardware or memory devices sometime after setting up the printer, then turn the printer off, and unplug the power cord from the electrical outlet before continuing. If you have any other devices attached to the printer, then turn them off as well, and unplug any cables going into the printer.
-  **CAUTION—SHOCK HAZARD:** To avoid the risk of electrical shock, do not use the fax feature during a lightning storm.
-  **CAUTION—SHOCK HAZARD:** To avoid the risk of electrical shock when cleaning the exterior of the printer, unplug the power cord from the electrical outlet and disconnect all cables from the printer before proceeding.
-  **CAUTION—POTENTIAL INJURY:** If the printer weight is greater than 20 kg (44 lb), then it may require two or more people to lift it safely.
-  **CAUTION—POTENTIAL INJURY:** When moving the printer, follow these guidelines to avoid personal injury or printer damage:
- Make sure that all doors and trays are closed.
 - Turn off the printer, and then unplug the power cord from the electrical outlet.
 - Disconnect all cords and cables from the printer.
 - If the printer has separate floor-standing optional trays or output options attached to it, then disconnect them before moving the printer.
 - If the printer has a caster base, then carefully roll it to the new location. Use caution when passing over thresholds and breaks in flooring.
 - If the printer does not have a caster base but is configured with optional trays or output options, then remove the output options and lift the printer off the trays. Do not try to lift the printer and any options at the same time.
 - Always use the handholds on the printer to lift it.
 - Any cart used to move the printer must have a surface able to support the full footprint of the printer.
 - Any cart used to move the hardware options must have a surface able to support the dimensions of the options.
 - Keep the printer in an upright position.
 - Avoid severe jarring movements.
 - Make sure that your fingers are not under the printer when you set it down.
 - Make sure that there is adequate clearance around the printer.

-  **CAUTION—TIPPING HAZARD:** Installing one or more options on your printer or MFP may require a caster base, furniture, or other feature to prevent instability causing possible injury. For more information on supported configurations, see www.lexmark.com/multifunctionprinters.
-  **CAUTION—TIPPING HAZARD:** To reduce the risk of equipment instability, load each tray separately. Keep all other trays closed until needed.
-  **CAUTION—HOT SURFACE:** The inside of the printer might be hot. To reduce the risk of injury from a hot component, allow the surface to cool before touching it.
-  **CAUTION—PINCH HAZARD:** To avoid the risk of a pinch injury, use caution in areas marked with this label. Pinch injuries may occur around moving parts, such as gears, doors, trays, and covers.
-  **CAUTION—POTENTIAL INJURY:** This product uses a laser. Use of controls or adjustments or performance of procedures other than those specified in the *User's Guide* may result in hazardous radiation exposure.
-  **CAUTION—POTENTIAL INJURY:** The lithium battery in this product is not intended to be replaced. There is a danger of explosion if a lithium battery is incorrectly replaced. Do not recharge, disassemble, or incinerate a lithium battery. Discard used lithium batteries according to the manufacturer's instructions and local regulations.



WARNING

- **INGESTION HAZARD:** This product contains a button cell or coin battery.
- **DEATH** or serious injury can occur if ingested.
- A swallowed button cell or coin battery can cause **Internal Chemical Burns** in as little as **2 hours**.
- **KEEP** new and used batteries **OUT OF REACH of CHILDREN**.
- **Seek immediate medical attention** if a battery is suspected to be swallowed or inserted inside any part of the body.



Remove and immediately recycle or dispose of used batteries according to local regulations and keep away from children. Do not dispose of batteries in household trash or incinerate. Even used batteries may cause severe injury or death. Call a local poison control center for treatment information.

Battery type: CR6821

Nominal battery voltage: 3V

Do not force discharge, recharge, disassemble, heat above 60°C (140°F), or incinerate. Doing so may result in injury due to venting, leakage, or explosion resulting in chemical burns.

This equipment is not suitable for use in locations where children are likely to be present.

This product is designed, tested, and approved to meet strict global safety standards with the use of specific manufacturer's components. The safety features of some parts may not always be obvious. The manufacturer is not responsible for the use of other replacement parts.

Refer service or repairs, other than those described in the user documentation, to a service representative.

SAVE THESE INSTRUCTIONS.

Learn about the printer

Finding information about the printer

What are you looking for?	Find it here
Initial setup instructions	See the setup documentation that came with the printer.
<ul style="list-style-type: none"> • Printer software • Print or fax driver • Printer firmware • Utility 	Go to www.lexmark.com/downloads , search for your printer model, and then in the Type menu, select the driver, firmware, or utility that you need.
<ul style="list-style-type: none"> • Selecting and storing paper and specialty media • Loading paper • Configuring printer settings • Viewing and printing documents and photos • Configuring the printer on a network • Caring for and maintaining the printer • Troubleshooting and solving problems 	Information Center—Go to https://infoserve.lexmark.com . How-to videos—Go to https://infoserve.lexmark.com/idv/ . Touch Screen Guide—Go to http://support.lexmark.com .
Setting up and configuring the accessibility features of your printer	<i>Lexmark Accessibility Guide</i> —Go to http://support.lexmark.com .
Help information for using the printer software.	Help for Microsoft Windows or Macintosh operating systems—Open a printer software program or application, and then click Help . Click  to view context-sensitive information. Notes: <ul style="list-style-type: none"> • Help is automatically installed with the printer software. • Depending on the operating system, the printer software is either in the printer program folder or on the desktop.





What are you looking for?	Find it here
<ul style="list-style-type: none"> • Documentation • Live chat support • E-mail support • Voice support 	<p>Go to http://support.lexmark.com.</p> <p>Note: Select your country or region, and then select your product to view the appropriate support site.</p> <p>Support contact information for your country or region can be found on the website or on the printed warranty that came with the printer.</p> <p>Have the following information ready when you contact customer support:</p> <ul style="list-style-type: none"> • Place and date of purchase • Machine type and serial number <p>For more information, see “Finding the printer serial number” on page 10.</p>
<ul style="list-style-type: none"> • Safety information • Regulatory information • Warranty information • Environmental information 	<p>Warranty information varies by country or region:</p> <ul style="list-style-type: none"> • In the U.S.—See the Statement of Limited Warranty included with the printer, or go to http://support.lexmark.com. • In other countries and regions—See the printed warranty that came with the printer. <p><i>Product Information Guide</i>—See the documentation that came with the printer or go to http://support.lexmark.com.</p>
<p>Information on Lexmark digital passport</p>	<p>Go to https://csr.lexmark.com/digital-passport.php.</p>

Finding the printer serial number

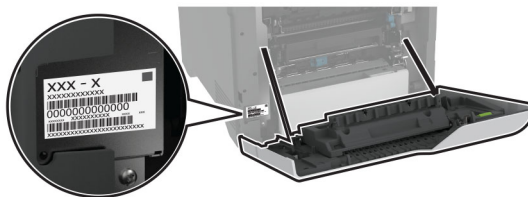
- 1 Open door A.
- 2 Locate the serial number.



Printer configurations

-  **CAUTION—TIPPING HAZARD:** Installing one or more options on your printer or MFP may require a caster base, furniture, or other feature to prevent instability causing possible injury. For more information on supported configurations, see www.lexmark.com/multifunctionprinters.
-  **CAUTION—TIPPING HAZARD:** To reduce the risk of equipment instability, load each tray separately. Keep all other trays closed until needed.

You can configure your printer by adding four optional 550-sheet trays.

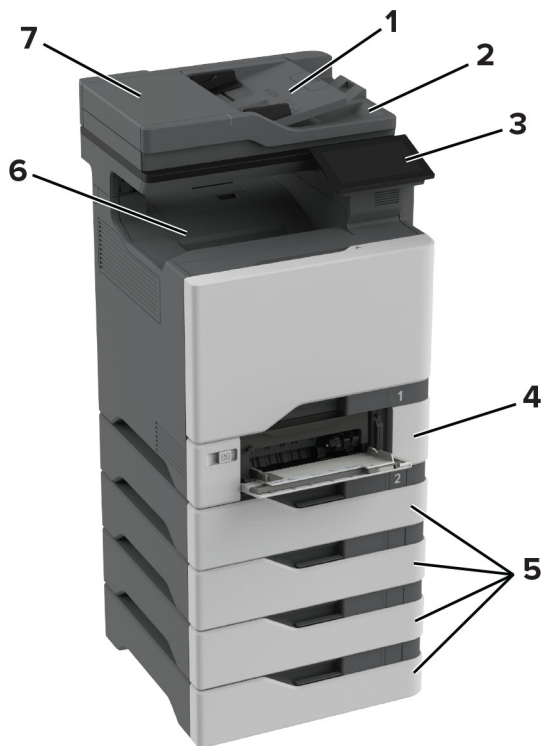

1	ADF tray
2	ADF bin
3	Control panel
4	650-sheet duo tray Note: The tray is composed of a 550-sheet tray and a 100-sheet multipurpose feeder.
5	Optional 550-sheet trays
6	Standard bin
7	Automatic document feeder (ADF)

Using the control panel

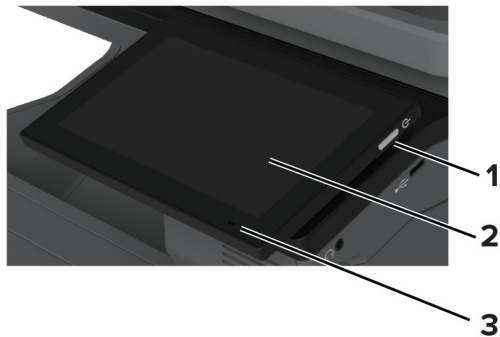

	Control panel part	Function
1	Power button	<ul style="list-style-type: none"> Turn on or turn off the printer. <p>Note: To turn off the printer, press and hold the power button for five seconds.</p> <ul style="list-style-type: none"> Set the printer to Sleep mode. Wake the printer from Sleep or Hibernate mode.
2	Display	<ul style="list-style-type: none"> View the printer messages and supply status. Set up and operate the printer.
3	Indicator light	Check the status of the printer.

Understanding the status of the indicator light

Indicator light	Printer status
Off	The printer is off.
Solid blue	The printer is ready.
Blinking blue	The printer is printing or processing data.
Blinking red	The printer requires user intervention.
Solid amber	The printer is in Sleep mode.
Blinking amber	The printer is in Deep Sleep or Hibernate mode.

Selecting paper

Paper guidelines

Use the appropriate paper to prevent jams and help ensure trouble-free printing.

- Always use new, undamaged paper.
- Before loading paper, know the recommended printable side of the paper. This information is usually indicated on the paper package.
- Do not use paper that has been cut or trimmed by hand.
- Do not mix paper sizes, types, or weights in the same tray; mixing results in jams.
- Do not use coated papers unless they are specifically designed for electrophotographic printing.

For more information, see the *Paper and Specialty Media Guide*.

Paper characteristics

The following paper characteristics affect print quality and reliability. Consider these factors before printing on them.

Weight

Trays can feed paper of varying weights. Paper lighter than 60 g/m² (16 lb) may not be stiff enough to feed properly, and may cause jams. For more information, see the “Supported paper weights” topic.

Curl

Curl is the tendency for paper to curl at its edges. Excessive curl can cause paper feeding problems. Curl can occur after the paper passes through the printer, where it is exposed to high temperatures. Storing paper unwrapped in hot, humid, cold, or dry conditions can contribute to paper curling before printing and can cause feeding problems.

Smoothness

Paper smoothness directly affects print quality. If paper is too rough, toner cannot fuse to it properly. If paper is too smooth, it can cause paper feeding or print quality issues. We recommend the use of paper with 50 Sheffield points.

Moisture content

The amount of moisture in paper affects both print quality and the printer ability to feed the paper correctly. Leave paper in its original wrapper until you use it. Exposure of paper to moisture changes can degrade its performance.

Before printing, store paper in its original wrapper for 24 to 48 hours. The environment in which the paper is stored must be the same as the printer. Extend the time several days if the storage or transportation environment is very different from the printer environment. Thick paper may also require a longer conditioning period.

Grain direction

Grain refers to the alignment of the paper fibers in a sheet of paper. Grain is either *grain long* which runs the length of the paper, or *grain short* which runs the width of the paper. For recommended grain direction, see the “Supported paper weights” topic.

Fiber content

Most high-quality xerographic paper is made from 100 percent chemically treated pulped wood. This content provides the paper with a high degree of stability, resulting in fewer paper feeding problems and better print quality. Paper containing fibers such as cotton can negatively affect paper handling.

Unacceptable paper

The following paper types are not recommended for use with the printer:

- Chemically treated papers that are used to make copies without carbon paper. They are also known as carbonless papers, carbonless copy paper (CCP), or no carbon required (NCR) paper.
- Preprinted papers with chemicals that may contaminate the printer.
- Preprinted papers that can be affected by the temperature in the printer fuser.
- Preprinted papers that require a registration (the precise print location on the page) greater than ±2.3 mm (±0.09 in.). For example, optical character recognition (OCR) forms.

Sometimes, registration can be adjusted with a software app to print successfully on these forms.

- Coated papers (erasable bond), synthetic papers, or thermal papers.

- Rough-edged, rough or heavily textured surface papers, or curled papers.
- Papers that fail EN12281:2002 (European).
- Paper weighing less than 60 g/m² (16 lb).
- Multiple-part forms or documents.

Storing paper

Use these paper storage guidelines to help avoid jams and uneven print quality:

- Store paper in its original wrapper in the same environment as the printer for 24 to 48 hours before printing.
- Extend the time several days if the storage or transportation environment is very different from the printer environment. Thick paper may also require a longer conditioning period.
- For best results, store paper where the temperature is 21°C (70°F) and the relative humidity is 40 percent.
- Most label manufacturers recommend printing in a temperature range of 18–24°C (65–75°F) with relative humidity between 40 and 60 percent.
- Store paper in cartons, on a pallet or shelf, rather than on the floor.
- Store individual packages on a flat surface.
- Do not store anything on top of individual paper packages.
- Take paper out of the carton or wrapper only when you are ready to load it in the printer. The carton and wrapper help keep the paper clean, dry, and flat.

Selecting preprinted forms and letterhead

- Use grain long paper.
- Use only forms and letterhead printed using an offset lithographic or engraved printing process.
- Avoid paper with rough or heavily textured surfaces.
- Use inks that are not affected by the resin in toner. Inks that are oxidation-set or oil-based generally meet these requirements; latex inks might not.
- Print samples on preprinted forms and letterheads considered for use before buying large quantities. This action determines whether the ink in the preprinted form or letterhead affects print quality.
- When in doubt, contact your paper supplier.
- When printing on letterhead, load the paper in the proper orientation for your printer. For more information, see the *Paper and Specialty Media Guide*.

Supported paper sizes

Paper size	650-sheet duo tray		Optional 550-sheet tray	Two-sided printing	Scanner	ADF
	550-sheet tray	100-sheet multipurpose feeder ¹				
A4 210 x 297 mm (8.27 x 11.7 in.)	✓	✓	✓	✓	✓	✓
A5 landscape² 210 x 148 mm (8.27 x 5.83 in.)	✓	✓	✓	✓	✓	✓
A5 portrait² 148 x 210 mm (5.83 x 8.27 in.)	✓	✓	✓	✓	✓	✓
A6 105 x 148 mm (4.13 x 5.83 in.)	✓	✓	✓	✓	✓	✓
Banner 215.9 x 1320.8 mm (8.5 x 52 in.)	x	✓	x	x	x	x
Executive 184.2 x 266.7 mm (7.25 x 10.5 in.)	✓	✓	✓	✓	✓	✓
Folio 215.9 x 330.2 mm (8.5 x 13 in.)	✓	✓	✓	✓	✓	✓
Hagaki 100 x 148 mm (3.94 x 5.83 in.)	x	✓	x	x	✓	x
JIS B5 182 x 257 mm (7.17 x 10.1 in.)	✓	✓	✓	✓	✓	✓

¹ Does not support automatic size sensing.

² Supported in both the portrait and landscape orientations. When fed in the portrait orientation, A5 is treated as narrow paper. When fed in landscape orientation, it is treated as a regular width paper.

³ When Universal is selected, the page is formatted for 215.9 x 355.6 mm (8.5 x 14 in.) unless the size is specified by the software application.

⁴ Load narrow paper in portrait orientation.

⁵ When Other Envelope is selected, the page is formatted for 215.9 x 355.6 mm (8.5 x 14 in.) unless a size is specified by the software application.

Paper size	650-sheet duo tray		Optional 550-sheet tray	Two-sided printing	Scanner	ADF
	550-sheet tray	100-sheet multipurpose feeder ¹				
Legal 215.9 x 355.6 mm (8.5 x 14 in.)	✓	✓	✓	✓	✓	✓
Letter 215.9 x 279.4 mm (8.5 x 11 in.)	✓	✓	✓	✓	✓	✓
Oficio (Mexico) 216 x 340 mm (8.5 x 13.4 in.)	✓	✓	✓	✓	✓	✓
Statement 139.7 x 215.9 mm (5.5 x 8.5 in.)	✓	✓	✓	✓	✓	✓
Universal^{3, 4} 76.2 x 127 mm to 215.9 x 355.6 mm (3 x 5 in. to 8.5 x 14 in.)	x	✓	x	x	✓	x
Universal^{3, 4} 105 x 148 mm to 215.9 x 355.6 mm (4.13 x 5.83 in. to 8.5 x 14 in.)	✓	✓	✓	✓	✓	x
7 3/4 Envelope 98.4 x 190.5 mm (3.875 x 7.5 in.)	x	✓	x	x	✓	x
9 Envelope 98.4 x 225.4 mm (3.875 x 8.9 in.)	x	✓	x	x	✓	x
10 Envelope 104.8 x 241.3 mm (4.12 x 9.5 in.)	✓	✓	✓	x	✓	x

¹ Does not support automatic size sensing.

² Supported in both the portrait and landscape orientations. When fed in the portrait orientation, A5 is treated as narrow paper. When fed in landscape orientation, it is treated as a regular width paper.

³ When Universal is selected, the page is formatted for 215.9 x 355.6 mm (8.5 x 14 in.) unless the size is specified by the software application.

⁴ Load narrow paper in portrait orientation.

⁵ When Other Envelope is selected, the page is formatted for 215.9 x 355.6 mm (8.5 x 14 in.) unless a size is specified by the software application.

Paper size	650-sheet duo tray		Optional 550-sheet tray	Two-sided printing	Scanner	ADF
	550-sheet tray	100-sheet multipurpose feeder ¹				
11 Envelope 114.3 x 263.525 mm (4.5 x 10.375 in.)	✓	✓	✓	X	✓	X
12 Envelope 120.65 x 279.4 mm (4.75 x 11 in.)	✓	✓	✓	X	✓	X
B5 Envelope 176 x 250 mm (6.93 x 9.84 in.)	✓	✓	✓	X	✓	X
B6 Envelope 125 x 176 mm (4.92 x 6.92 in.)	✓	✓	✓	X	✓	X
C5 Envelope 162 x 229 mm (6.38 x 9.01 in.)	✓	✓	✓	X	✓	X
C6 Envelope 114 x 162 mm (4.48 x 6.37 in.)	✓	✓	✓	X	✓	X
DL Envelope 110 x 220 mm (4.33 x 8.66 in.)	✓	✓	✓	X	✓	X
Monarch 98.4 x 190.5 mm (3.875 x 7.5 in.)	X	✓	X	X	✓	X
Other Envelope⁵ 98.4 x 162 mm to 176 x 250 mm (3.87 x 6.38 in. to 6.93 x 9.84 in.)	X	✓	X	X	✓	X

¹ Does not support automatic size sensing.

² Supported in both the portrait and landscape orientations. When fed in the portrait orientation, A5 is treated as narrow paper. When fed in landscape orientation, it is treated as a regular width paper.

³ When Universal is selected, the page is formatted for 215.9 x 355.6 mm (8.5 x 14 in.) unless the size is specified by the software application.

⁴ Load narrow paper in portrait orientation.

⁵ When Other Envelope is selected, the page is formatted for 215.9 x 355.6 mm (8.5 x 14 in.) unless a size is specified by the software application.

Supported paper types

Paper type	650-sheet duo tray		Optional 550-sheet tray	Two-sided printing	Scanner	ADF
	550-sheet tray	100-sheet multipurpose feeder				
Plain	✓	✓	✓	✓	✓	✓
Card stock	✓	✓	✓	✓	✓	x
Recycled	✓	✓	✓	✓	✓	✓
Glossy	✓	✓	✓	✓	✓	x
Labels	✓	✓	✓	✓	✓	x
Vinyl Labels	✓	✓	✓	x	✓	x
Bond	✓	✓	✓	✓	✓	✓
Envelope	✓	✓	✓	x	✓	x
Letterhead	✓	✓	✓	✓	✓	✓
Preprinted	✓	✓	✓	✓	✓	✓
Colored Paper	✓	✓	✓	✓	✓	✓
Light	✓	✓	✓	✓	✓	✓
Heavy	✓	✓	✓	✓	✓	✓
Rough/Cotton	✓	✓	✓	✓	✓	✓
Transparency	x	x	x	x	x	x
Custom Type [x]	✓	✓	✓	✓	✓	✓

Notes:

- Labels, envelopes, and card stock always print at reduced speed.
- Card stock is supported in two-sided printing only up to 163 g/m² (90-lb index). Anything heavier is supported only in one-sided printing.
- Vinyl labels are supported for occasional use only and must be tested for acceptability. Some vinyl labels may feed more reliably from the multipurpose feeder.

Supported paper weights

650-sheet duo tray		Optional 550-sheet tray	Two-sided printing	ADF
550-sheet tray	100-sheet multipurpose feeder			
60–218 g/m ² (16–58-lb bond)	60–218 g/m ² (16–58-lb bond)	60–218 g/m ² (16–58-lb bond)	60–162 g/m ² (16–43-lb bond)	52–120 g/m ² (14–32-lb bond)

Paper type	Paper weight
Plain Paper	75–90.3 g/m ² (20–24 lb bond)
Glossy	88–176 g/m ² (60–120 lb book)
	162–176 g/m ² grain long (60–65 lb cover)
Heavy Paper	90.3–105 g/m ² grain long (24.1–28 lb bond)
Card stock	Up to 199 g/m ² grain long (110 lb index)
	Up to 218 g/m ² grain short (80 lb cover)
Labels	Up to 218 g/m ² (58 lb bond)
Envelopes	60–105 g/m ² (16–28 lb bond)

Notes:

- For 60 to 176 g/m² (16–47-lb bond) paper, grain long fibers are recommended.
- Paper less than 75 g/m² (20-lb bond) must be printed with Paper Type set to Light Paper. Failure to do so may cause excessive curl which can lead to feeding errors, especially in more humid environments.
- Two-sided printing supports paper weight from 60-162 g/m² (16–43-lb bond) paper.
- 100% cotton content maximum weight is 90 g/m² (24-lb bond).

Set up, install, and configure

Selecting a location for the printer

- Leave enough room to open trays, covers, and doors and to install hardware options.
- Set up the printer near an electrical outlet.

⚠ CAUTION—POTENTIAL INJURY: To avoid the risk of fire or electrical shock, connect the power cord to an appropriately rated and properly grounded electrical outlet that is near the product and easily accessible.

⚠ CAUTION—SHOCK HAZARD: To avoid the risk of electrical shock, do not place or use this product near water or wet locations.

- Make sure that airflow in the room meets the latest revision of the ASHRAE 62 standard or the CEN Technical Committee 156 standard.
- Provide a flat, sturdy, and stable surface.
- Keep the printer:
 - Clean, dry, and free of dust.
 - Away from stray staples and paper clips.
 - Away from the direct airflow of air conditioners, heaters, or ventilators.
 - Free from direct sunlight and humidity extremes.
- Observe the recommended temperatures and avoid fluctuations:

Ambient temperature	10 to 32.2°C (50 to 90°F)
Storage temperature	15.6 to 32.2°C (60 to 90°F)

- Allow the following recommended amount of space around the printer for proper ventilation:

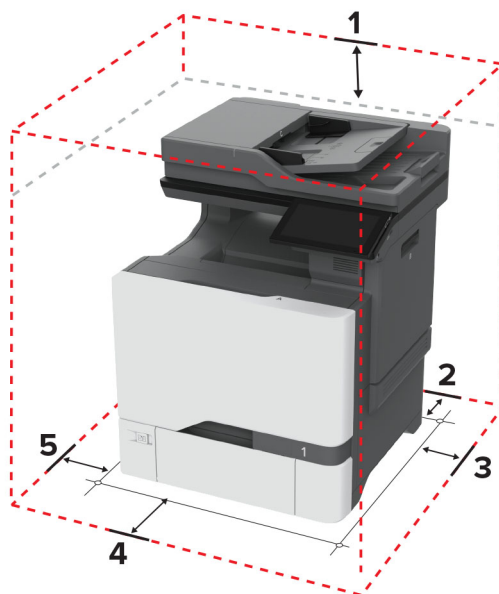

1	Top	229 mm (9 in.)
2	Rear	101.6 mm (4 in.)
3	Right side	178 mm (7 in.)
4	Front	508 mm (20 in.)
5	Left side	127 mm (5 in.)

Attaching cables

- ⚠ CAUTION—SHOCK HAZARD:** To avoid the risk of electrical shock, do not set up this product or make any electrical or cabling connections, such as the power cord, fax feature, or telephone, during a lightning storm.
- ⚠ CAUTION—POTENTIAL INJURY:** To avoid the risk of fire or electrical shock, connect the power cord to an appropriately rated and properly grounded electrical outlet that is near the product and easily accessible.
- ⚠ CAUTION—POTENTIAL INJURY:** To avoid the risk of fire or electrical shock, use only the power cord provided with this product or the manufacturer's authorized replacement.
- ⚠ CAUTION—POTENTIAL INJURY:** To reduce the risk of fire, use only a 26 AWG or larger telecommunications (RJ-11) cord when connecting this product to the public switched telephone network. For users in Australia, the cord must be approved by the Australian Communications and Media Authority.

Warning—Potential Damage: To avoid loss of data or printer malfunction, do not touch the USB cable, any wireless network adapter, or the printer in the areas shown while actively printing.

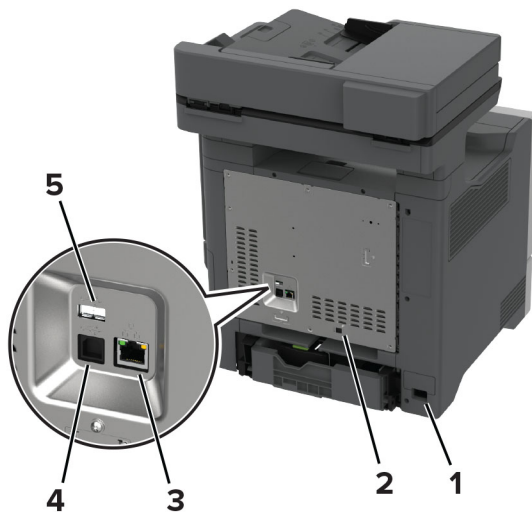

	Printer port	Function
1	Power cord socket	Connect the printer to a properly grounded electrical outlet.
2	LINE port Note: Available only in some printer models.	Connect the printer to an active telephone line through a standard wall jack (RJ-11), DSL filter, or VoIP adapter, or any other adapter that allows you to access the telephone line to send and receive faxes.

	Printer port	Function
3	Ethernet port	Connect the printer to a network.
4	USB printer port	Connect the printer to a computer.
5	USB port	Attach a keyboard or any compatible option.

Setting up and using the home screen applications

Using the home screen

Note: Your home screen may vary depending on your home screen customization settings, administrative setup, and active embedded solutions.



#	Icon	Function
1	Stop or Cancel button	Stop the current job.
2	Copy	Make copies.
3	Change Language	Change the language on the printer display.
4	E-mail	Send e-mails.
5	Settings	Access the printer menus.
6	Fax	Send fax.
7	Address Book	Access, create, and organize contacts.
8	Status/Supplies	<ul style="list-style-type: none"> Show a printer warning or error message whenever the printer requires intervention to continue processing. View more information on the printer warning or message, and on how to clear it. <p>Note: You can also access this setting by touching the top section of the home screen.</p>

#	Icon	Function
9	Held Jobs	Show all the current held print jobs
10	Job Queue	Show all the current print jobs. Note: You can also access this setting by touching the top section of the home screen.
11	USB Drive	View, select, or print photos and documents from a flash drive.
12	Scan Profiles	Scan and save documents directly to the computer.
13	FTP	Scan and save documents directly to an FTP server.
14	Bookmarks	Organize all bookmarks.
15	Hard Disk	View, select, and manage documents from a hard drive or an intelligent storage drive.
16	Network Folder	Scan to a network folder or network location.
17	Start button	Start a job, depending on which mode is selected.
18	On-screen keypad	Enter numbers or symbols in an input field.

Customizing the home screen

- 1 Open a web browser, and then type the printer IP address in the address field.

Notes:

- View the printer IP address on the printer home screen. The IP address appears as four sets of numbers separated by periods, such as 123.123.123.123.
- If you are using a proxy server, then temporarily disable it to load the web page correctly.

- 2 Click **Settings** > **Device** > **Home Screen Customization**.

- 3 Do one or more of the following:

- To add an icon to the home screen, click **+**, select the app name, and then click **Add**.
- To remove a home screen icon, select the app name, and then click **Remove**.
- To customize an app name, select the app name, click **Edit**, and then assign a name.
- To restore the name of an app, select the app name, click **Edit**, and then select **Restore app label**.
- To add a space between apps, click **+**, select **BLANK SPACE**, and then click **Add**.
- To arrange the apps, drag the app names in the order that you want.
- To restore the default home screen, click **Restore home screen**.

- 4 Apply the changes.

Supported applications

Application	Printer models
Scan Center	CX730, CX735, XC4342, XC4352
Shortcut Center	CX730, CX735, XC4342, XC4352
Card Copy	CX730, CX735, XC4342, XC4352

Application	Printer models
Display Customization	CX730, CX735, XC4342, XC4352
Customer Support	XC4342, XC4352
Device Quotas	XC4342, XC4352

Setting up Scan Center

- 1 From the home screen, touch **Scan Center**.
- 2 Select and create a destination, and then configure the settings.

Notes:

- When creating a network destination, make sure to validate and adjust the settings until no errors occur.
- Only destinations created from the Embedded Web Server are saved. For more information, see the documentation that came with the solution.

- 3 Apply the changes.

Creating a shortcut

- 1 From the home screen, touch **Shortcut Center**.

Note: The icon and name may have been changed. For more information, contact your administrator.

- 2 Select a printer function, and then touch **Create Shortcut**.

Note: The Secure E-mail function is not supported.

- 3 Configure the settings, and then touch **Save**.

- 4 Type a unique shortcut name.

Note: To avoid clipped names on the home screen, type only up to 25 characters.

- 5 Touch **OK**.

The application automatically generates a unique shortcut number.

Note: To launch the shortcut, touch , touch #, and then enter the shortcut number.

Setting up Card Copy

- 1 Open a web browser, and then type the printer IP address in the address field.

Notes:

- View the printer IP address on the printer home screen. The IP address appears as four sets of numbers separated by periods, such as 123.123.123.123.
- If you are using a proxy server, then temporarily disable it to load the web page correctly.

- 2 Click **Apps > Card Copy > Configure**.

Notes:

- Make sure that Display Icon is enabled.
- Make sure that E-mail Settings and Network Share Settings are configured.
- When scanning a card, make sure that the scan resolution does not exceed 200 dpi for color and 400 dpi for black and white.
- When scanning multiple cards, make sure that the scan resolution does not exceed 150 dpi for color and 300 dpi for black and white.

3 Apply the changes.

Note: You need a printer hard disk or an intelligent storage drive to scan multiple cards.

Using Display Customization

Before using the application, make sure to do the following:

- From the Embedded Web Server, click **Apps > Display Customization > Configure**.
- Enable and configure the screen saver, slideshow, and wallpaper settings.

Managing screen saver and slide show images

1 From the Screen Saver and Slideshow Images section, add, edit, or delete an image.

Notes:

- You can add up to 10 images.
- When enabled, the status icons appear on the screen saver only when there are errors, warnings, or cloud-based notifications.

2 Apply the changes.

Changing the wallpaper image

1 From the home screen, touch **Change Wallpaper**.

2 Select an image to use.

3 Apply the changes.

Running a slide show from a flash drive

1 Insert a flash drive into the USB port.

2 From the home screen, touch **Slideshow**.

Images appear in alphabetical order.

Note: You can remove the flash drive after the slide show starts, but the images are not stored in the printer. If the slide show stops, then insert the flash drive again to view the images.

Using Customer Support

Notes:

- This application is supported only in some printer models. For more information, see [“Supported applications” on page 23](#).

- For information on how to configure the application settings, see the *Customer Support Administrator's Guide*.
- 1 From the home screen, touch **Customer Support**.
 - 2 Print or e-mail the information.

Setting up Device Quotas

Notes:

- This application is supported only in some printer models. For more information, see [“Supported applications” on page 23](#).
- For information on how to configure the application settings, see the *Device Quotas Administrator's Guide*.

- 1 Open a web browser, and then type the printer IP address in the address field.

Notes:

- View the printer IP address on the printer home screen. The IP address appears as four sets of numbers separated by periods, such as 123.123.123.123.
- If you are using a proxy server, then temporarily disable it to load the web page correctly.

- 2 Click **Apps > Device Quotas > Configure**.
- 3 In the User Accounts section, add or edit a user, and then set the user quota.
- 4 Apply the changes.

Managing bookmarks

Creating bookmarks

Use bookmarks to print frequently accessed documents that are stored in servers or on the web.

- 1 Open a web browser, and then type the printer IP address in the address field.

Notes:

- View the printer IP address on the printer home screen. The IP address appears as four sets of numbers separated by periods, such as 123.123.123.123.
- If you are using a proxy server, then temporarily disable it to load the web page correctly.

- 2 Click **Bookmarks > Add Bookmark**, and then type a bookmark name.
- 3 Select an Address protocol type, and then do one of the following:
 - For HTTP and HTTPS, type the URL that you want to bookmark.
 - For HTTPS, make sure to use the host name instead of the IP address. For example, type **myWebsite.com/sample.pdf** instead of typing **123.123.123.123/sample.pdf**. Make sure that the host name also matches the Common Name (CN) value in the server certificate. For more information on obtaining the CN value in the server certificate, see the help information for your web browser.
 - For FTP, type the FTP address. For example, **myServer/myDirectory**. Enter the FTP port number. Port 21 is the default port for sending commands.

- For SMB, type the network folder address. For example, **myServer/myShare/myFile.pdf**. Type the network domain name.
- If necessary, select the Authentication type for FTP and SMB.

To limit access to the bookmark, enter a PIN.

Note: The application supports the following file types: PDF, JPEG, and TIFF. Other file types such as DOCX and XLSX are supported in some printer models.

4 Click **Save**.

Creating folders

1 Open a web browser, and then type the printer IP address in the address field.

Notes:

- View the printer IP address on the printer home screen. The IP address appears as four sets of numbers separated by periods, such as 123.123.123.123.
- If you are using a proxy server, then temporarily disable it to load the web page correctly.

2 Click **Bookmarks > Add Folder**, and then type a folder name.

Note: To limit access to the folder, enter a PIN.





3 Click **Save**.

Note: You can create folders or bookmarks inside a folder. To create a bookmark, see [“Creating bookmarks” on page 26](#).

Managing contacts

1 From the home screen, touch **Address Book**.

2 Do one or more of the following:

- To add a contact, touch  on top of the screen, and then touch **Create Contact**. If necessary, specify a login method to allow application access.
- To delete a contact, touch  on top of the screen, touch **Delete Contacts**, and then select the contact.
- To edit contact information, touch the contact name.
- To create a group, touch  on top of the screen, and then touch **Create Group**. If necessary, specify a login method to allow application access.
- To delete a group, touch  on top of the screen, touch **Delete Groups**, and then select the group.
- To edit a contact group, touch **GROUPS >** select a group name  **>** select the action you want to make.

3 Apply the changes.

Setting up and using the accessibility features

Activating Voice Guidance

From the home screen

- 1 In one motion and using one finger, slowly swipe left then up on the display until you hear a voice message.

Note: For printer models without built-in speakers, use headphones to hear the message.

- 2 Using two fingers, touch **OK**.

Note: If the gesture does not work, then apply more pressure.

From the keyboard

- 1 Press and hold the **5** key until you hear a voice message.

Note: For printer models without built-in speakers, use headphones to hear the message.

- 2 Press **Tab** to navigate the focus cursor to the OK button, and then press **Enter**.

Notes:

- When Voice Guidance is activated, always use two fingers to select any item on the display.
- Voice Guidance has limited language support.

Deactivating Voice Guidance

- 1 In one motion and using one finger, slowly swipe left then up on the display until you hear a voice message.

Note: For printer models without built-in speakers, use headphones to hear the message.

- 2 Using two fingers, do either of the following:

- Touch **Voice Guidance**, then touch **OK**.
- Touch **Cancel**.

Note: If the gesture does not work, then apply more pressure.

You can also deactivate Voice Guidance by doing either of the following:

- Using two fingers, double tap the home screen.
- Press the power button to put the printer in Sleep or Hibernate mode.

Navigating the screen using gestures

Notes:

- Most of the gestures are applicable only when Voice Guidance is activated.
- Use a physical keyboard to type characters and adjust certain settings.

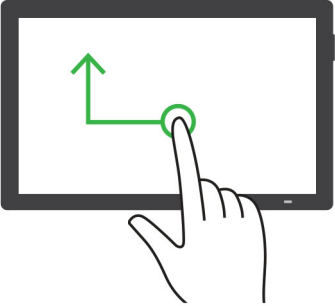
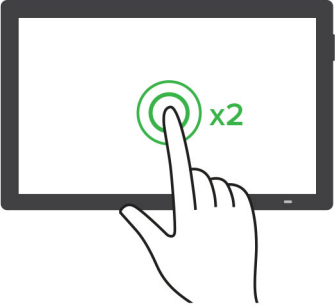
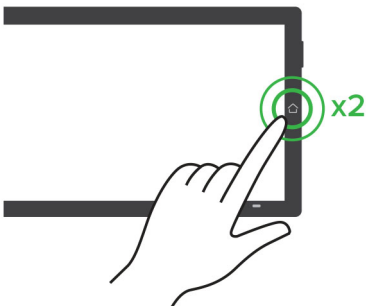
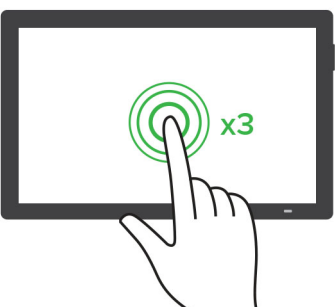
Gesture	Function
<p data-bbox="149 289 565 317">Swipe left then up using one finger</p> 	<p data-bbox="584 289 984 317">Launch or exit Accessibility mode.</p> <p data-bbox="584 331 1433 359">Note: This gesture is also applicable when the printer is in normal mode.</p>
<p data-bbox="149 705 483 732">Double-tap using one finger</p> 	<p data-bbox="584 705 1040 732">Select an option or item on the screen.</p>
<p data-bbox="149 1121 571 1184">Double-tap the home icon using two fingers</p> 	<p data-bbox="584 1121 989 1148">Deactivate the Accessibility mode.</p>
<p data-bbox="149 1558 459 1585">Triple-tap using one finger</p> 	<p data-bbox="584 1558 1029 1585">Zoom in or zoom out text and images.</p> <p data-bbox="584 1600 1268 1627">Note: Enable Magnification mode to use the zoom feature.</p>

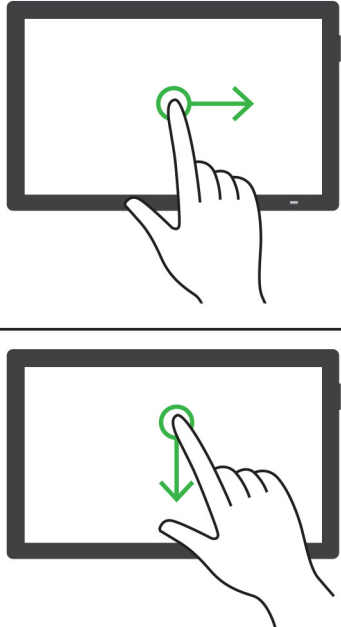
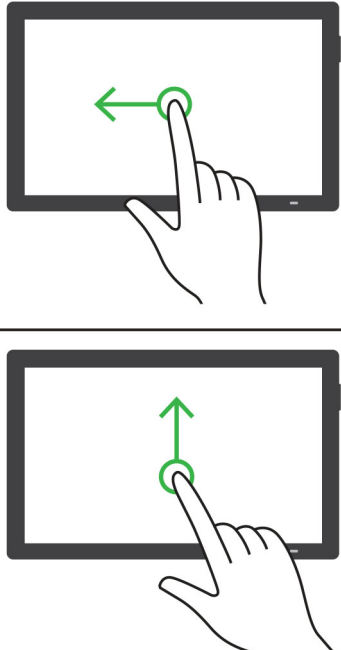
Gesture	Function
<p data-bbox="149 279 571 338">Swipe right or swipe down using one finger</p> 	<p data-bbox="584 279 1016 306">Move to the next item on the screen.</p>
<p data-bbox="149 1045 571 1104">Swipe left or swipe up using one finger</p> 	<p data-bbox="584 1045 1065 1073">Move to the previous item on the screen.</p>

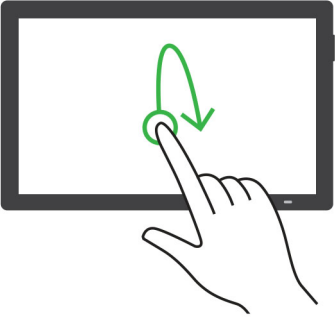
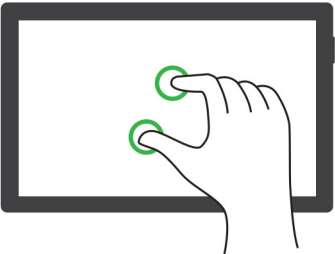
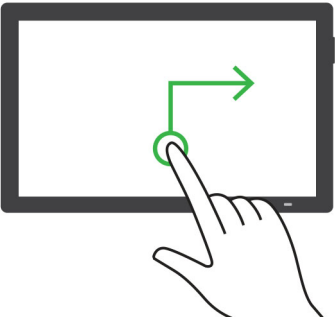
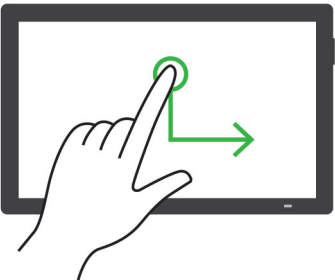
Gesture	Function
<p data-bbox="149 277 516 340">Swipe up then down using one finger</p> 	<p data-bbox="584 277 1008 306">Move to the first item on the screen.</p>
<p data-bbox="149 735 196 764">Pan</p> 	<p data-bbox="584 735 1451 764">Access parts of the zoomed image that are beyond the limit of the screen.</p> <p data-bbox="584 785 667 814">Notes:</p> <ul data-bbox="607 835 1230 907" style="list-style-type: none"><li data-bbox="607 835 1117 865">• Use two fingers to drag a zoomed image.<li data-bbox="607 873 1230 907">• Enable Magnification mode to use the pan gesture.
<p data-bbox="149 1096 570 1125">Swipe up then right using one finger</p> 	<p data-bbox="584 1096 829 1125">Increase the volume.</p> <p data-bbox="584 1138 1435 1167">Note: This gesture is also applicable when the printer is in normal mode.</p>
<p data-bbox="149 1520 537 1583">Swipe down then right using one finger</p> 	<p data-bbox="584 1520 846 1549">Decrease the volume.</p> <p data-bbox="584 1562 1435 1591">Note: This gesture is also applicable when the printer is in normal mode.</p>

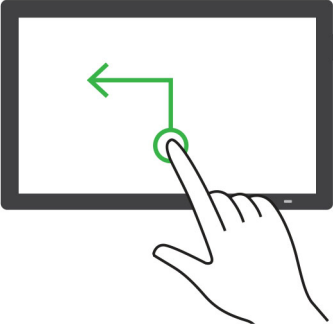
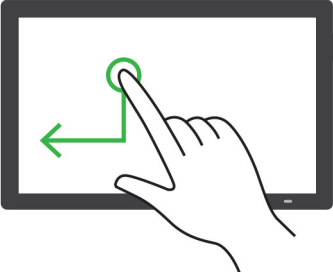
Gesture	Function
Swipe up then left using one finger 	Exit an application and return to the home screen.
Swipe down then left using one finger 	Go back to the previous setting.

Using the on-screen keyboard

When the on-screen keyboard appears, do one or more of the following:

- Touch a key to announce and type the character in the field.
- Drag a finger across different characters to announce and type the character in the field.
- Touch a text box using two fingers to announce the characters in the field.
- Touch **Backspace** to delete characters.

Enabling Magnification mode

1 In one motion and using one finger, slowly swipe left then up on the display until you hear a voice message.

Note: For printer models without built-in speakers, use headphones to hear the message.

2 Using two fingers, do the following:

- a Touch **Magnification mode**.
- b Touch **OK**.

Note: If the gesture does not work, then apply more pressure.

For more information on navigating a magnified screen, see [“Navigating the screen using gestures” on page 28](#).

Adjusting the Voice Guidance speech rate

- 1 From the home screen, touch **Settings** > **Device** > **Accessibility** > **Speech Rate**.
- 2 Select the speech rate.

Adjusting the default headphone volume

- 1 From the home screen, touch **Settings** > **Device** > **Accessibility**.
- 2 Adjust the headphone volume.

Note: The volume resets to the default value after the user exits Accessibility mode or when the printer wakes from Sleep or Hibernate mode.

Adjusting the default internal speaker volume

- 1 From the home screen, touch .
- 2 Adjust the volume.

Notes:

- If Quiet Mode is enabled, then audible alerts are turned off. This setting also slows the printer performance.
- The volume resets to the default value after the user exits Accessibility mode or when the printer wakes from Sleep or Hibernate mode.

Enabling spoken passwords or personal identification numbers

- 1 From the home screen, touch **Settings** > **Device** > **Accessibility** > **Speak Passwords/PINs**.
- 2 Enable the setting.

Setting up the printer to fax

Supported fax

Printer model	Analog fax	etherFAX ²	Fax server ³	Fax over IP (FoIP) ⁴
CX730	√ ₁	√	√	√
CX735	√	√	√	√

¹ Needs an installed fax card to use analog fax.

² Needs a subscription. For more information, go to <https://www.etherfax.net/lexmark> or contact the place where you purchased the printer.

³ Needs a subscription for the fax server to work.

⁴ Needs an installed license bundle. For more information, contact the place where you purchased the printer.

Printer model	Analog fax	etherFAX ²	Fax server ³	Fax over IP (FoIP) ⁴
XC4342	√ ¹	√	√	√
XC4352	√	√	√	√

¹ Needs an installed fax card to use analog fax.

² Needs a subscription. For more information, go to <https://www.etherfax.net/lexmark> or contact the place where you purchased the printer.

³ Needs a subscription for the fax server to work.

⁴ Needs an installed license bundle. For more information, contact the place where you purchased the printer.

Setting up the fax function using analog fax

Notes:

- For some printer models, a fax card must be installed for the printer to use analog fax.
- Some connection methods are applicable only in some countries or regions.
- If the fax function is enabled and not fully set up, then the indicator light may blink red.
- If you do not have a TCP/IP environment, then use the control panel to set up fax.

Warning—Potential Damage: To avoid loss of data or printer malfunction, do not touch cables or the printer in the area shown while actively sending or receiving a fax.



Using the Settings menu in the printer

- 1 From the home screen, touch **Settings > Fax > Fax Setup > General Fax Settings**.
- 2 Configure the settings.

Using the Embedded Web Server

- 1 Open a web browser, and then type the printer IP address in the address field.

Notes:

- View the printer IP address on the home screen. The IP address appears as four sets of numbers separated by periods, such as 123.123.123.123.
- If you are using a proxy server, then temporarily disable it to load the web page correctly.

2 Click **Settings > Fax > Fax Setup > General Fax Settings**.

3 Configure the settings.

4 Apply the changes.

Setting up the fax function using etherFAX

Notes:

- The printer firmware must be updated to the latest version. For more information, see the “Updating firmware” section.
- An appropriate license bundle must be installed in your printer. For more information, contact etherFAX.
- Make sure that you have registered your printer to the etherFAX portal. For more information, go to <https://www.etherfax.net/lexmark>.
- The printer serial number is required on registration. To locate the serial number, see [“Finding the printer serial number” on page 10](#).

1 Open a web browser, and then type the printer IP address in the address field.

Notes:

- View the printer IP address on the home screen. The IP address appears as four sets of numbers separated by periods, such as 123.123.123.123.
- If you are using a proxy server, then temporarily disable it to load the web page correctly.

2 Click **Settings > Fax > Fax Setup > General Fax Settings**.

Note: Fax Setup appears only if Fax Mode is set to Fax.

3 In the Fax Name field, type a unique name.

4 In the Fax Number field, enter the fax number that etherFAX provided.

5 From the Fax Transport menu, select **etherFAX**.

Notes:

- This menu shows up only when more than one fax transport is available.
- If the printer only has etherFAX installed, then it is automatically configured.

6 Apply the changes.

Setting up the fax function using fax server

Notes:

- This feature lets you send fax messages to a fax service provider that supports e-mail receiving.
- This feature supports outgoing fax messages only. To support fax receive, make sure that you have a device-based fax, such as analog fax, etherFAX, or Fax over IP (FoIP), configured in your printer.

1 Open a web browser, and then type the printer IP address in the address field.

Notes:

- View the printer IP address on the home screen. The IP address appears as four sets of numbers separated by periods, such as 123.123.123.123.
- If you are using a proxy server, then temporarily disable it to load the web page correctly.

2 Click **Settings > Fax**.

3 From the Fax Mode menu, select **Fax Server**, and then click **Save**.

4 Click **Fax Server Setup**.

5 In the To Format field, type **[#]@myfax.com**, where **[#]** is the fax number and **myfax.com** is the fax provider domain.

Notes:

- If necessary, configure the Reply Address, Subject, or Message fields.
- To let the printer receive fax messages, enable the device-based fax receive setting. Make sure that you have a device-based fax configured.

6 Click **Save**.

7 Click **Fax Server E-mail Settings**, and then do either of the following:

- Enable **Use E-mail SMTP Server**.

Note: If the E-mail SMTP settings are not configured, then see [“Configuring the e-mail SMTP settings” on page 40](#).

- Configure the SMTP settings. For more information, contact your e-mail service provider.

8 Apply the changes.

Setting up fax using a standard telephone line

Note: These instructions apply only to printers that support analog fax. For more information, see [“Supported fax” on page 33](#).

 **CAUTION—SHOCK HAZARD:** To avoid the risk of electrical shock, do not set up this product or make any electrical or cabling connections, such as the power cord, fax feature, or telephone, during a lightning storm.

 **CAUTION—SHOCK HAZARD:** To avoid the risk of electrical shock, do not use the fax feature during a lightning storm.

⚠ CAUTION—POTENTIAL INJURY: To reduce the risk of fire, use only a 26 AWG or larger telecommunications (RJ-11) cord when connecting this product to the public switched telephone network. For users in Australia, the cord must be approved by the Australian Communications and Media Authority.

Setup 1: Printer is connected to a dedicated fax line

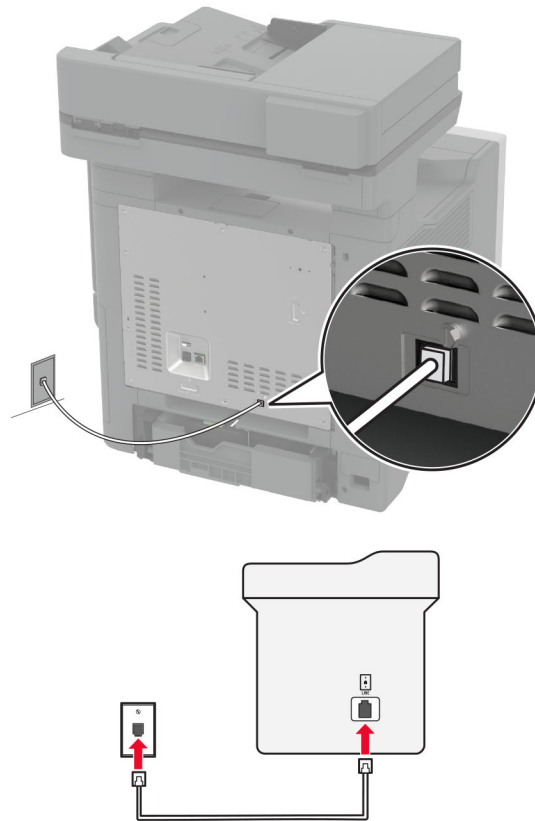

- 1 Connect one end of the telephone cable to the line port of the printer.
- 2 Connect the other end of the cable to an active analog wall jack.

Notes:

- You can set the printer to receive faxes automatically (set Auto Answer to **On**) or manually (set Auto Answer to **Off**).
- If you want to receive faxes automatically, then set the printer to pick up on a specified number of rings.

Setup 2: Printer is sharing the line with an answering machine

Note: If you subscribe to a distinctive ring service, then make sure that you set the correct ring pattern for the printer. Otherwise, the printer does not receive faxes even if you have set it to receive faxes automatically.

Connected to different wall jacks

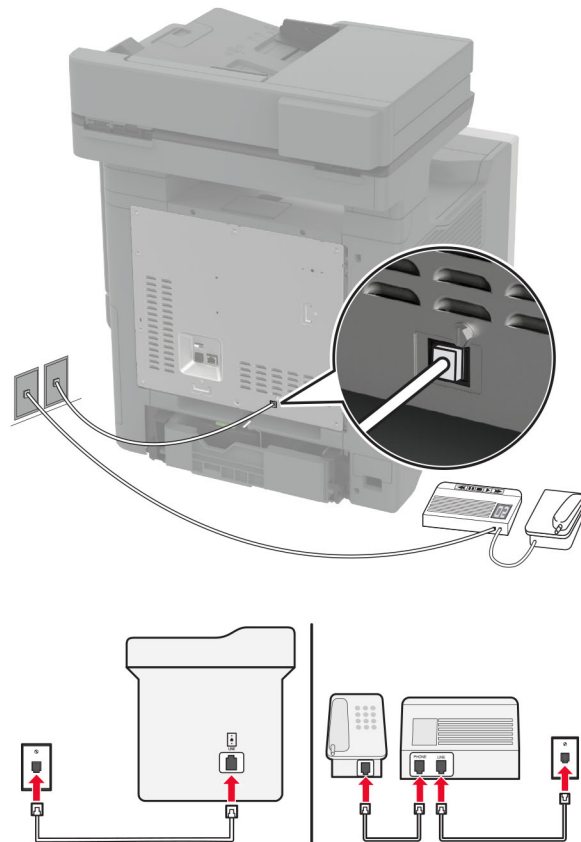

- 1 Connect one end of the telephone cable to the line port of the printer.
- 2 Connect the other end of the cable to an active analog wall jack.

Notes:

- If you have only one telephone number on your line, then set the printer to receive faxes automatically.
- Set the printer to pick up calls two rings after the answering machine. For example, if the answering machine picks up calls after four rings, then set the printer Rings to Answer setting to **6**.

Setting up fax in countries or regions with different telephone wall jacks and plugs

Note: These instructions apply only to printers that support analog fax. For more information, see [“Supported fax” on page 33](#).

⚠ CAUTION—SHOCK HAZARD: To avoid the risk of electrical shock, do not set up this product or make any electrical or cabling connections, such as the power cord, fax feature, or telephone, during a lightning storm.

⚠ CAUTION—SHOCK HAZARD: To avoid the risk of electrical shock, do not use the fax feature during a lightning storm.

⚠ CAUTION—POTENTIAL INJURY: To reduce the risk of fire, use only a 26 AWG or larger telecommunications (RJ-11) cord when connecting this product to the public switched telephone network. For users in Australia, the cord must be approved by the Australian Communications and Media Authority.

The standard wall jack adopted by most countries or regions is RJ-11. If the wall jack or equipment in your facility is not compatible with this type of connection, then use a telephone adapter. An adapter for your country or region may not come with your printer, and you may need to purchase it separately.

There may be an adapter plug installed in the telephone port of the printer. Do not remove the adapter plug from the telephone port of the printer if you are connecting to a serial or cascaded telephone system.

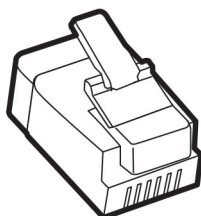

Part name	Part number
Lexmark adapter plug	40X8519

Connecting the printer to a non-RJ-11 wall jack

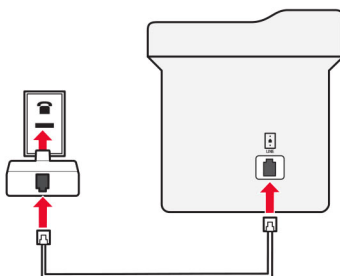
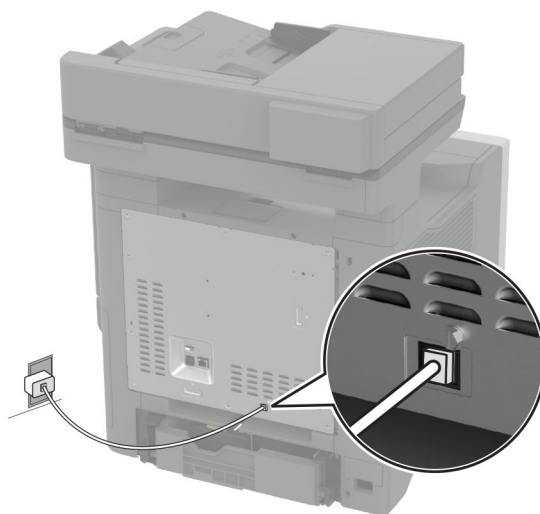

- 1 Connect one end of the telephone cable to the line port of the printer.
- 2 Connect the other end of the cable to the RJ-11 adapter, and then connect the adapter to the wall jack.
- 3 If you want to connect another device with a non-RJ-11 connector to the same wall jack, then connect it directly to the telephone adapter.

Connecting to a distinctive ring service

A distinctive ring service lets you have multiple telephone numbers on one telephone line. Each telephone number is assigned a different ring pattern.

Note: These instructions apply only to printers that support analog fax. For more information, see [“Supported fax” on page 33](#).

- 1 From the home screen, touch **Settings > Fax > Fax Setup > Fax Receive Settings > Admin Controls > Answer On**.
- 2 Select a ring pattern.

Setting the fax date and time

Note: Make sure that fax is configured. For more information, see the [Setting up the printer to fax](#) section.

- 1 From the home screen, touch **Settings > Device > Preferences > Date and Time > Configure**.
- 2 Configure the settings.

Configuring daylight saving time

Note: Make sure that fax is configured. For more information, see the [Setting up the printer to fax](#) section.

- 1 From the home screen, touch **Settings > Device > Preferences > Date and Time > Configure**.
- 2 In the Time Zone menu, touch **(UTC+user) Custom**.
- 3 Touch **UTC (GMT) Offset**, and then configure the settings.

Configuring the fax speaker settings

Note: Make sure that fax is configured. For more information, see the [Setting up the printer to fax](#) section.

- 1 From the home screen, touch **Settings > Fax > Fax Setup > Speaker Settings**.
- 2 Do the following:
 - Set Speaker Mode to **Always On**.
 - Set Speaker Volume to **High**.
 - Enable Ringer Volume.

Configuring the e-mail SMTP settings

Configure the Simple Mail Transfer Protocol (SMTP) settings to send a scanned document through e-mail. The settings vary with each e-mail service provider.

Before you begin, make sure that the printer is connected to a network and that the network is connected to the Internet.

Using the Embedded Web Server

- 1 Open a web browser, and then type the printer IP address in the address field.

Notes:

- View the printer IP address on the printer home screen. The IP address appears as four sets of numbers separated by periods, such as 123.123.123.123.
- If you are using a proxy server, then temporarily disable it to load the web page correctly.

- 2 Click **Settings** > **E-mail**.

- 3 From the E-mail Setup section, configure the settings.

Notes:

- For more information, see the list of [e-mail service providers](#).
- For e-mail service providers that are not on the list, contact your provider and ask for the settings.

- 4 Click **Save**.

Using the Settings menu in the printer

- 1 From the home screen, touch **Settings** > **E-mail** > **E-mail Setup**.

- 2 Configure the settings.

Notes:

- For more information, see the list of [e-mail service providers](#).
- For e-mail service providers that are not on the list, contact your provider and ask for the settings.

E-mail service providers

- [AOL Mail](#)
- [Comcast Mail](#)
- [Gmail](#)
- [iCloud Mail](#)
- [Mail.com](#)
- [NetEase Mail \(mail.126.com\)](#)
- [NetEase Mail \(mail.163.com\)](#)
- [NetEase Mail \(mail.yeah.net\)](#)
- [Outlook Live or Microsoft 365](#)
- [QQ Mail](#)
- [Sina Mail](#)
- [Sohu Mail](#)
- [Yahoo! Mail](#)
- [Zoho Mail](#)

Notes:

- If you encounter errors using the settings provided, then contact your e-mail service provider.
- For e-mail service providers that are not on the list, contact your provider.

AOL Mail

Setting	Value
Primary SMTP Gateway	smtp.aol.com
Primary SMTP Gateway Port	587
Use SSL/TLS	Required
Require Trusted Certificate	Disabled
Reply Address	Your e-mail address
SMTP Server Authentication	Login / Plain
Device-Initiated E-mail	Use Device SMTP Credentials
Device UserID	Your e-mail address
Device Password	App password Note: To create an app password, go to the AOL Account Security page, log in to your account, and then click Generate app password .

Comcast Mail

Setting	Value
Primary SMTP Gateway	smtp.comcast.net
Primary SMTP Gateway Port	587
Use SSL/TLS	Required
Require Trusted Certificate	Disabled
Reply Address	Your e-mail address
SMTP Server Authentication	Login / Plain
Device-Initiated E-mail	Use Device SMTP Credentials
Device UserID	Your e-mail address
Device Password	Account password

Note: Make sure that the Third Party Access Security setting is enabled on your account. For more information, go to the [Comcast Xfinity Connect help page](#).

Gmail™

Note: Make sure that two-step verification is enabled on your Google account. To enable two-step verification, go to the [Google Account Security](#) page, log in to your account, and then from the “Signing in to Google” section, click **2-Step Verification**.

Setting	Value
Primary SMTP Gateway	smtp.gmail.com
Primary SMTP Gateway Port	587
Use SSL/TLS	Required
Require Trusted Certificate	Disabled
Reply Address	Your e-mail address
SMTP Server Authentication	Login / Plain
Device-Initiated E-mail	Use Device SMTP Credentials
Device UserID	Your e-mail address
Device Password	App password Notes: <ul style="list-style-type: none"> To create an app password, go to the Google Account Security page, log in to your account, and then from the “Signing in to Google” section, click App passwords. “App passwords” shows only if two-step verification is enabled.

iCloud Mail

Note: Make sure that two-step verification is enabled on your account.

Setting	Value
Primary SMTP Gateway	smtp.mail.me.com
Primary SMTP Gateway Port	587
Use SSL/TLS	Required
Require Trusted Certificate	Disabled
Reply Address	Your e-mail address
SMTP Server Authentication	Login / Plain
Device-Initiated E-mail	Use Device SMTP Credentials
Device UserID	Your e-mail address
Device Password	App password Note: To create an app password, go to the iCloud Account Management page, log in to your account, and then from the Security section, click Generate Password .

Mail.com

Setting	Value
Primary SMTP Gateway	smtp.mail.com
Primary SMTP Gateway Port	587
Use SSL/TLS	Required
Require Trusted Certificate	Disabled
Reply Address	Your e-mail address
SMTP Server Authentication	Login / Plain
Device-Initiated E-mail	Use Device SMTP Credentials
Device UserID	Your e-mail address
Device Password	Account password

NetEase Mail (mail.126.com)

Note: Make sure that the SMTP service is enabled on your account. To enable the service, from the NetEase Mail home page, click **Settings > POP3/SMTP/IMAP**, and then enable either **IMAP/SMTP service** or **POP3/SMTP service**.

Setting	Value
Primary SMTP Gateway	smtp.126.com
Primary SMTP Gateway Port	465
Use SSL/TLS	Required
Require Trusted Certificate	Disabled
Reply Address	Your e-mail address
SMTP Server Authentication	Login / Plain
Device-Initiated E-mail	Use Device SMTP Credentials
Device UserID	Your e-mail address
Device Password	Authorization password Note: The authorization password is provided when IMAP/SMTP service or POP3/SMTP service is enabled.

NetEase Mail (mail.163.com)

Note: Make sure that the SMTP service is enabled on your account. To enable the service, from the NetEase Mail home page, click **Settings > POP3/SMTP/IMAP**, and then enable either **IMAP/SMTP service** or **POP3/SMTP service**.

Setting	Value
Primary SMTP Gateway	smtp.163.com
Primary SMTP Gateway Port	465
Use SSL/TLS	Required

Setting	Value
Require Trusted Certificate	Disabled
Reply Address	Your e-mail address
SMTP Server Authentication	Login / Plain
Device-Initiated E-mail	Use Device SMTP Credentials
Device UserID	Your e-mail address
Device Password	Authorization password Note: The authorization password is provided when IMAP/SMTP service or POP3/SMTP service is enabled.

NetEase Mail (mail.yeah.net)

Note: Make sure that the SMTP service is enabled on your account. To enable the service, from the NetEase Mail home page, click **Settings > POP3/SMTP/IMAP**, and then enable either **IMAP/SMTP service** or **POP3/SMTP service**.

Setting	Value
Primary SMTP Gateway	smtp.yeah.net
Primary SMTP Gateway Port	465
Use SSL/TLS	Required
Require Trusted Certificate	Disabled
Reply Address	Your e-mail address
SMTP Server Authentication	Login / Plain
Device-Initiated E-mail	Use Device SMTP Credentials
Device UserID	Your e-mail address
Device Password	Authorization password Note: The authorization password is provided when IMAP/SMTP service or POP3/SMTP service is enabled.

Outlook Live or Microsoft 365

These settings apply to outlook.com and hotmail.com e-mail domains, and Microsoft 365 accounts.

Setting	Value
Primary SMTP Gateway	smtp.office365.com
Primary SMTP Gateway Port	587
Use SSL/TLS	Required
Require Trusted Certificate	Disabled
Reply Address	Your e-mail address
SMTP Server Authentication	Login / Plain
Device-Initiated E-mail	Use Device SMTP Credentials

Setting	Value
Device UserID	Your e-mail address
Device Password	Account password or app password Notes: <ul style="list-style-type: none"> • For accounts with two-step verification disabled, use your account password. • For outlook.com or hotmail.com accounts with two-step verification enabled, use an app password. To create an app password, go to the Outlook Live Account Management page, and then log in to your account.

Note: For additional setup options for business using Microsoft 365, go to the [Microsoft 365 help page](#).

QQ Mail

Note: Make sure that the SMTP service is enabled on your account. To enable the service, from the QQ Mail home page, click **Settings > Account**. From the POP3/IMAP/SMTP/Exchange/CardDAV/CalDAV Service section, enable either **POP3/SMTP service** or **IMAP/SMTP service**.

Setting	Value
Primary SMTP Gateway	smtp.qq.com
Primary SMTP Gateway Port	587
Use SSL/TLS	Required
Require Trusted Certificate	Disabled
Reply Address	Your e-mail address
SMTP Server Authentication	Login / Plain
Device-Initiated E-mail	Use Device SMTP Credentials
Device UserID	Your e-mail address
Device Password	Authorization code Note: To generate an authorization code, from the QQ Mail home page, click Settings > Account , and then from the POP3/IMAP/SMTP/Exchange/CardDAV/CalDAV Service section, click Generate authorization code .

Sina Mail

Note: Make sure that the POP3/SMTP service is enabled on your account. To enable the service, from the Sina Mail home page, click **Settings > More settings > User-end POP/IMAP/SMTP**, and then enable **POP3/SMTP service**.

Setting	Value
Primary SMTP Gateway	smtp.sina.com
Primary SMTP Gateway Port	587
Use SSL/TLS	Required

Setting	Value
Require Trusted Certificate	Disabled
Reply Address	Your e-mail address
SMTP Server Authentication	Login / Plain
Device-Initiated E-mail	Use Device SMTP Credentials
Device UserID	Your e-mail address
Device Password	Authorization code Note: To create an authorization code, from the e-mail home page, click Settings > More settings > User-end POP/IMAP/SMTP , and then enable Authorization code status .

Sohu Mail

Note: Make sure that the SMTP service is enabled on your account. To enable the service, from the Sohu Mail home page, click **Options > Settings > POP3/SMTP/IMAP**, and then enable either **IMAP/SMTP service** or **POP3/SMTP service**.

Setting	Value
Primary SMTP Gateway	smtp.sohu.com
Primary SMTP Gateway Port	465
Use SSL/TLS	Required
Require Trusted Certificate	Disabled
Reply Address	Your e-mail address
SMTP Server Authentication	Login / Plain
Device-Initiated E-mail	Use Device SMTP Credentials
Device UserID	Your e-mail address
Device Password	Independent password Note: The independent password is provided when IMAP/SMTP service or POP3/SMTP service is enabled.

Yahoo! Mail

Setting	Value
Primary SMTP Gateway	smtp.mail.yahoo.com
Primary SMTP Gateway Port	587
Use SSL/TLS	Required
Require Trusted Certificate	Disabled
Reply Address	Your e-mail address
SMTP Server Authentication	Login / Plain
Device-Initiated E-mail	Use Device SMTP Credentials
Device UserID	Your e-mail address

Setting	Value
Device Password	App password Note: To create an app password, go to the Yahoo Account Security page, log in to your account, and then click Generate app password .

Zoho Mail

Setting	Value
Primary SMTP Gateway	smtp.zoho.com
Primary SMTP Gateway Port	587
Use SSL/TLS	Required
Require Trusted Certificate	Disabled
Reply Address	Your e-mail address
SMTP Server Authentication	Login / Plain
Device-Initiated E-mail	Use Device SMTP Credentials
Device UserID	Your e-mail address
Device Password	Account password or app password Notes: <ul style="list-style-type: none"> • For accounts with two-step verification disabled, use your account password. • For accounts with two-step verification enabled, use an app password. To create an app password, go to the Zoho Mail Account Security page, log in to your account, and then from the Application-Specific Passwords section, click Generate New Password.

Loading paper and specialty media

Setting the size and type of the specialty media

The trays automatically detect the size of plain paper. For specialty media like labels, card stock, or envelopes, do the following:

- 1 From the home screen, touch **Settings > Paper > Tray Configuration > Paper Size/Type** > select a paper source.
- 2 Set the size and type of the specialty media.

Configuring Universal paper settings

- 1 From the home screen, touch **Settings > Paper > Media Configuration > Universal Setup**.
- 2 Configure the settings.

Enabling the Multiple Universal Sizes setting

- 1 From the home screen, touch **Settings** > **Device** > **Maintenance** > **Configuration Menu** > **Tray Configuration**.
- 2 Enable the Multiple Universal Sizes setting.

Loading trays

 **CAUTION—TIPPING HAZARD:** To reduce the risk of equipment instability, load each tray separately. Keep all other trays closed until needed.

- 1 Remove the tray.

Note: To avoid jams, do not remove trays while the printer is busy.

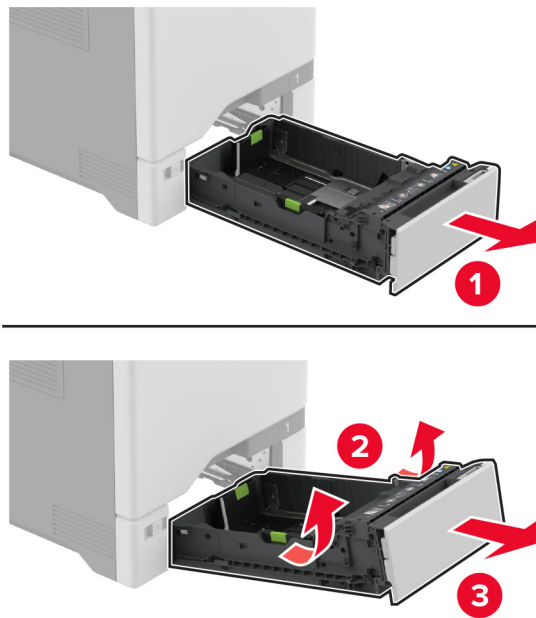

- 2 Adjust the guides to match the size of the paper that you are loading.

Note: Use the indicators on the bottom of the tray to position the guides.

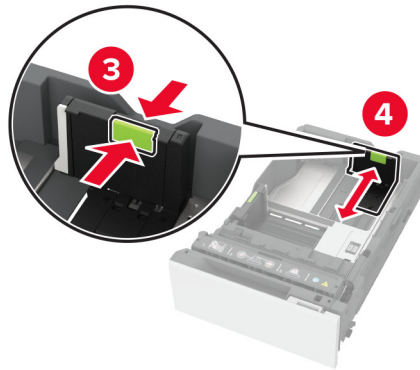
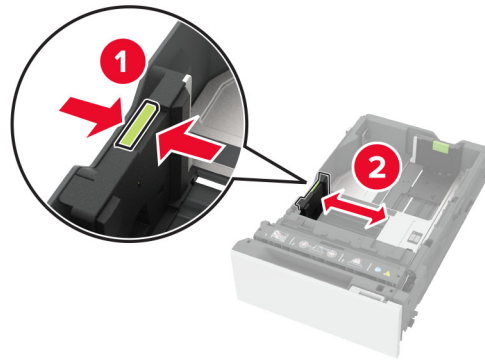

3 Flex, fan, and align the paper edges before loading.

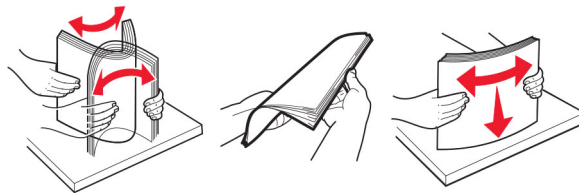

4 Load the paper stack with the printable side faceup.

- For one-sided printing, load letterhead faceup with the header toward the front of the tray.
- For two-sided printing, load letterhead facedown with the header toward the back of the tray.
- Do not slide paper into the tray.

- For plain paper, make sure that the stack height is below the maximum paper fill indicator. Overfilling may cause paper jams.

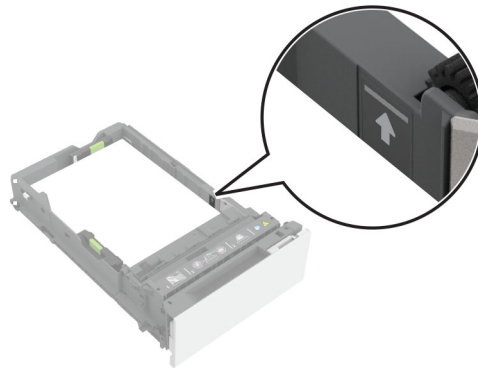

- For envelopes and other specialty media, make sure that the stack height is below the dashed line. Overfilling may cause paper jams.

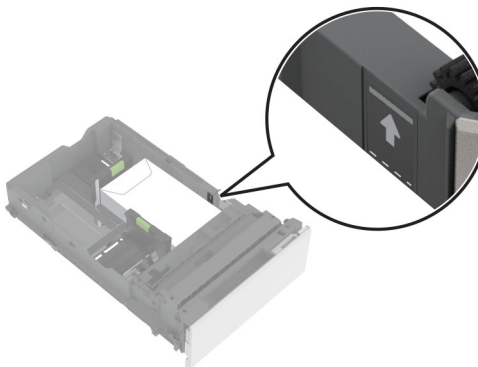
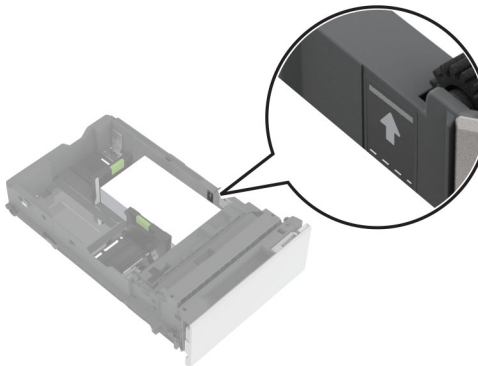

5 Insert the tray.

If necessary, set the paper size and type to match the paper loaded in the tray.

Loading the multipurpose feeder

- 1 Open the multipurpose feeder.

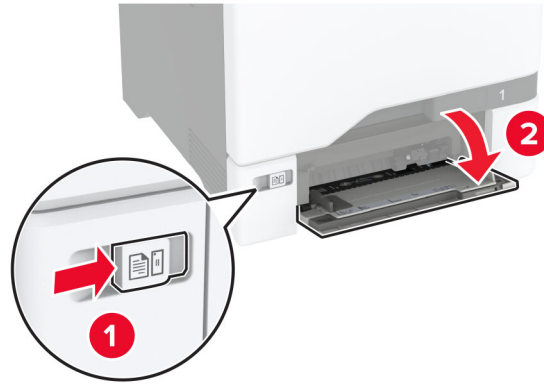

- 2 Adjust the guide to match the size of the paper that you are loading.



- 3 Flex, fan, and align the paper edges before loading.

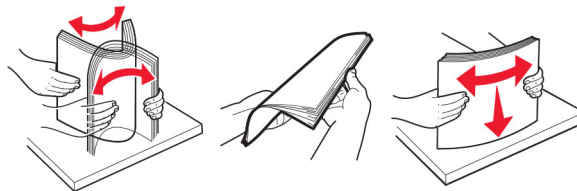

4 Load the paper.

- Load paper and card stock with the printable side facedown and the top edge entering the printer first.



- Load envelope with the flap side up and against the right side of the paper guide. Load European envelopes with the flap entering the printer first.



Warning—Potential Damage: Do not use envelopes with stamps, clasps, snaps, windows, coated linings, or self-stick adhesives.

Note: To avoid paper pick problems, make sure that the leading edge of the paper or specialty media is properly aligned with the separator dam.

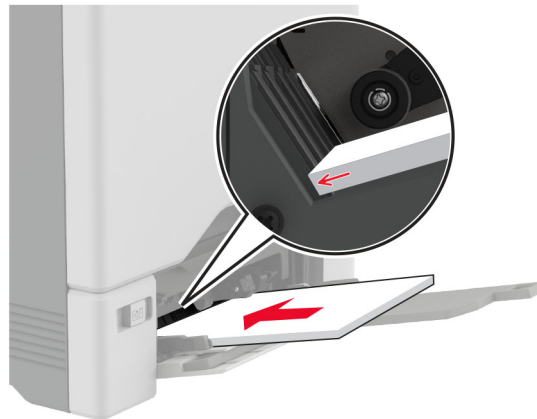

- 5 From the Paper menu in the control panel, set the paper size and type to match the paper loaded in the multipurpose feeder.

Linking trays

- 1 From the home screen, touch **Settings** > **Paper** > **Tray Configuration** > select a paper source.
- 2 Set the same paper size and paper type for the trays that you are linking.
- 3 From the home screen, touch **Settings** > **Device** > **Maintenance** > **Configuration Menu** > **Tray Configuration** > **Tray Linking**.
- 4 Touch **Automatic**.

To unlink trays, make sure that no trays have the same paper size and paper type settings.

Warning—Potential Damage: The temperature of the fuser varies according to the specified paper type. To avoid printing issues, match the paper type setting in the printer with the paper loaded in the tray.

Installing and updating software, drivers, and firmware

Installing the printer software

Notes:

- The print driver is included in the software installer package.
 - For Macintosh computers with macOS version 10.7 or later, you do not need to install the driver to print on an AirPrint-certified printer. If you want custom printing features, then download the print driver.
- 1 Obtain a copy of the software installer package.
 - From the software CD that came with your printer.
 - Go to www.lexmark.com/downloads.
 - 2 Run the installer, and then follow the instructions on the computer screen.

Installing the fax driver

- 1 Go to www.lexmark.com/downloads, search for your printer model, and then download the appropriate installer package.
- 2 From your computer, click **Printer Properties**, and then navigate to the **Configuration** tab.
- 3 Select **Fax**, and then click **Apply**.

Adding printers to a computer

Before you begin, do one of the following:

- Connect the printer and the computer to the same network. For more information on connecting the printer to a network, see [“Connecting the printer to a Wi-Fi network” on page 97](#).
- Connect the computer to the printer. For more information, see [“Connecting a computer to the printer” on page 99](#).
- Connect the printer to the computer using a USB cable. For more information, see [“Attaching cables” on page 21](#).

Note: The USB cable is sold separately.

For Windows users

- 1 From a computer, install the print driver.

Note: For more information, see [“Installing the printer software” on page 54](#).

- 2 Open **Printers & scanners**, and then click **Add a printer or scanner**.
- 3 Depending on your printer connection, do one of the following:
 - Select a printer from the list, and then click **Add device**.
 - Click **Show Wi-Fi Direct printers**, select a printer, and then click **Add device**.
 - Click **The printer that I want isn't listed**, and then from the Add Printer window, do the following:
 - a Select **Add a printer using a TCP/IP address or hostname**, and then click **Next**.
 - b In the “Hostname or IP address” field, type the printer IP address, and then click **Next**.

Notes:

- View the printer IP address on the printer home screen. The IP address appears as four sets of numbers separated by periods, such as 123.123.123.123.
- If you are using a proxy server, then temporarily disable it to load the web page correctly.

- c Select a print driver, and then click **Next**.
- d Select **Use the print driver that is currently installed (recommended)**, and then click **Next**.
- e Type a printer name, and then click **Next**.
- f Select a printer sharing option, and then click **Next**.
- g Click **Finish**.

For Macintosh users

- 1 From a computer, open **Printers & Scanners**.
- 2 Click **+**, and then select a printer.
- 3 From the Use menu, select a print driver.

Notes:

- To use the Macintosh print driver, select either **AirPrint** or **Secure AirPrint**.
- If you want custom printing features, then select the Lexmark print driver. To install the driver, see [“Installing the printer software” on page 54](#).

4 Add the printer.

Exporting or importing a configuration file

You can export the configuration settings of your printer into a text file, and then import the file to apply the settings to other printers.

1 Open a web browser, and then type the printer IP address in the address field.

Notes:

- View the printer IP address on the printer home screen. The IP address appears as four sets of numbers separated by periods, such as 123.123.123.123.
- If you are using a proxy server, then temporarily disable it to load the web page correctly.

2 From the Embedded Web Server, click **Export Configuration** or **Import Configuration**.

3 Follow the instructions on the screen.

4 If the printer supports applications, then do the following:

- a Click **Apps** > select the application > **Configure**.
- b Click **Export** or **Import**.

Adding available options in the print driver

For Windows users

1 Open the printers folder.

2 Select the printer you want to update, and then do either of the following:

- For Windows 7 or later, select **Printer properties**.
- For earlier versions, select **Properties**.

3 Navigate to the Configuration tab, and then select **Update Now - Ask Printer**.

4 Apply the changes.

For Macintosh users

1 From System Preferences in the Apple menu, navigate to your printer, and then select **Options & Supplies**.

2 Navigate to the list of hardware options, and then add any installed options.

3 Apply the changes.

Updating firmware

Updating the firmware using the control panel

Using the notification center

This method is applicable only in some printer models.

- 1 From the control panel, navigate to the notification center, and then select **Firmware update available**.

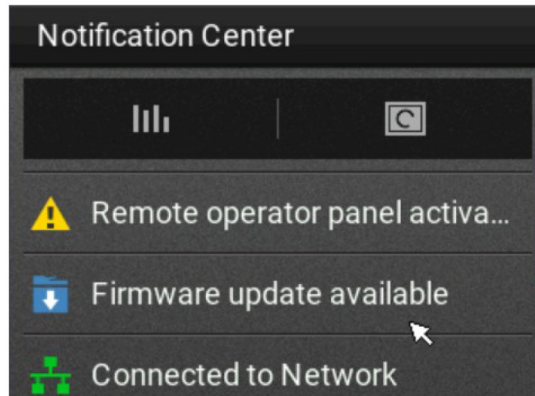

- 2 Select **Install now**.

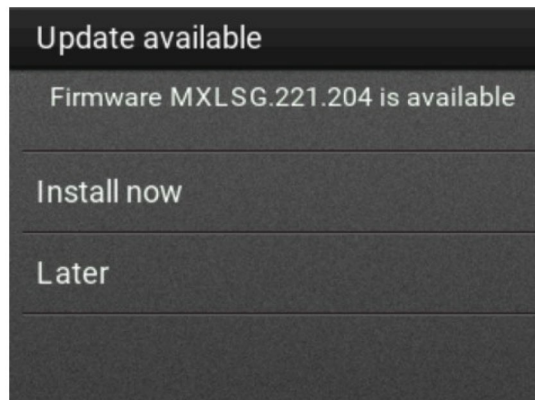

The printer reboots automatically after the update.

Using the Settings menu

- 1 From the control panel, navigate to **Settings > Device > Update Firmware**.
- 2 Depending on your printer model, select **Check for updates** or **Check for updates now**.
- 3 If a new update is available, then select **Install now**.

The printer reboots automatically after the update.

Updating the firmware using the Embedded Web Server

Before you begin, make sure that:

- You have downloaded the latest printer firmware from <https://support.lexmark.com> and saved it to your flash drive or computer.

Note: To deploy the printer firmware, extract the .fls firmware file from the ZIP package.

- You are not using a special code on your printer to avoid losing this functionality.

Warning—Potential Damage: Make sure that all printers receiving firmware updates are turned on during the entire firmware update process. Turning off a printer during a firmware update can severely damage it.

If the printer is connected to the network when checking for updates, then downloading the firmware is not required.

- 1 Open a web browser, and then type the printer IP address in the address field.

Notes:

- View the printer IP address on the printer home screen. The IP address appears as four sets of numbers separated by periods, such as 123.123.123.123.
- If you are using a proxy server, then temporarily disable it to load the web page correctly.

- 2 Click **Device**.

- 3 Scroll down, and then click **Update Firmware**.

- 4 Depending on your printer model, click **Check for updates** or **Check for updates now**.

If a new update is available, then click **I agree, start update**.

The printer reboots automatically after the update.

Installing hardware options

Available internal options

- Intelligent storage drive (ISD)
 - Fonts
 - Simplified Chinese
 - Traditional Chinese
 - Japanese
 - Korean
 - Arabic
 - Mass storage
- Printer hard disk
- Analog fax card
- Licensed features
 - IPDS
 - Bar Code

- Lexmark™ Internal solutions port
 - IEEE 1284-B Parallel Card
 - RS-232C Serial Card
 - Fiber Port
- Wireless print server
 - MarkNet™ N8370
 - MarkNet N8372
 - MarkNet N8450

Notes:

- An ISD or a hard disk is required to activate formsmerge and other features.
- Some IPDS features require an ISD or a hard disk.

Installing optional trays



CAUTION—SHOCK HAZARD: To avoid the risk of electrical shock, if you are accessing the controller board or installing optional hardware or memory devices sometime after setting up the printer, then turn the printer off, and unplug the power cord from the electrical outlet before continuing. If you have any other devices attached to the printer, then turn them off as well, and unplug any cables going into the printer.

- 1 Turn off the printer.
- 2 Unplug the power cord from the electrical outlet, and then from the printer.
- 3 Unpack the optional tray, and then remove all the packing material.

Note: If optional trays are already installed, then unlock them from the printer before lifting the printer. Do not try to lift the printer and trays at the same time.

- 4 Install the printer on top of the optional tray until it *clicks* into place.



CAUTION—POTENTIAL INJURY: If the printer weight is greater than 20 kg (44 lb), then it may require two or more people to lift it safely.

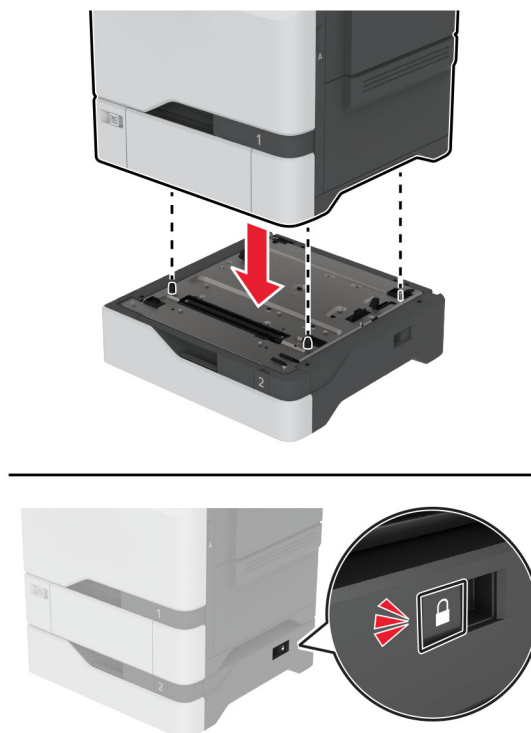

- 5 Connect the power cord to the printer, and then to the electrical outlet.

⚠ CAUTION—POTENTIAL INJURY: To avoid the risk of fire or electrical shock, connect the power cord to an appropriately rated and properly grounded electrical outlet that is near the product and easily accessible.

- 6 Turn on the printer.

Add the tray in the print driver to make it available for print jobs. For more information, see [“Adding available options in the print driver” on page 56](#).

Installing the intelligent storage drive

When a hard disk and an intelligent storage drive are both installed, the printer always prioritizes the hard disk to store user data.

⚠ CAUTION—SHOCK HAZARD: To avoid the risk of electrical shock, if you are accessing the controller board or installing optional hardware or memory devices sometime after setting up the printer, then turn the printer off, and unplug the power cord from the electrical outlet before continuing. If you have any other devices attached to the printer, then turn them off as well, and unplug any cables going into the printer.

- 1 Turn off the printer, and then unplug the power cord from the electrical outlet.
- 2 Using a flat-head screwdriver, remove the controller board shield.

Warning—Potential Damage: Controller board electronic components are easily damaged by static electricity. Touch a metal surface on the printer before touching any controller board components or connectors.

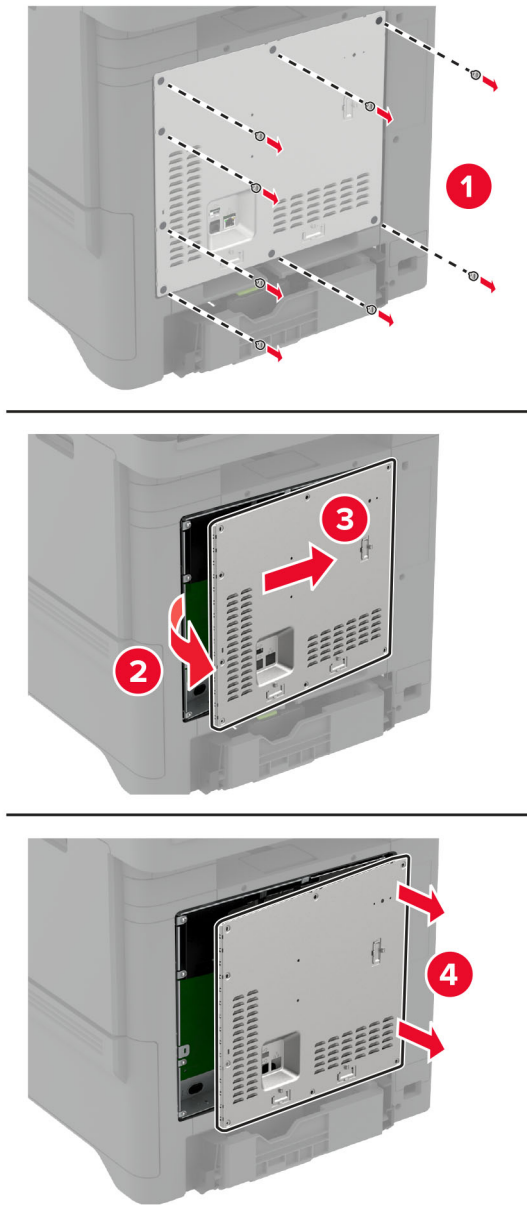

3 Unpack the intelligent storage drive (ISD).

Warning—Potential Damage: Avoid touching the connection points along the edge of the card.

4 Locate the ISD connector.

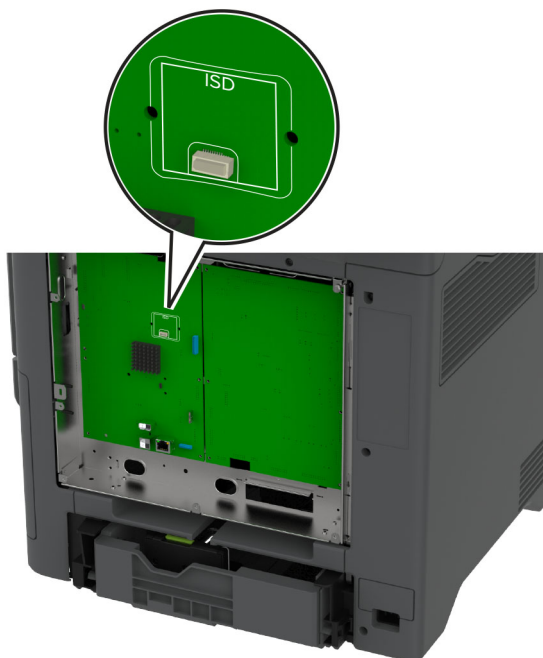

5 Insert the card to the ISD connector.

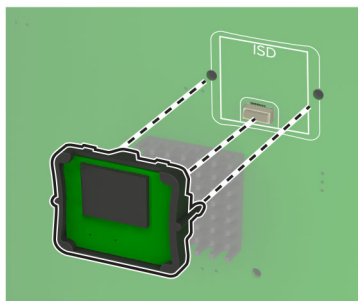
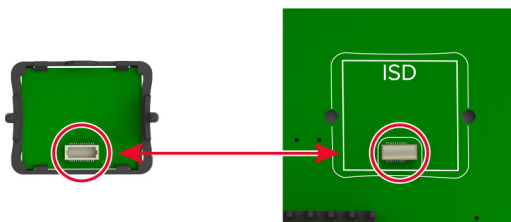

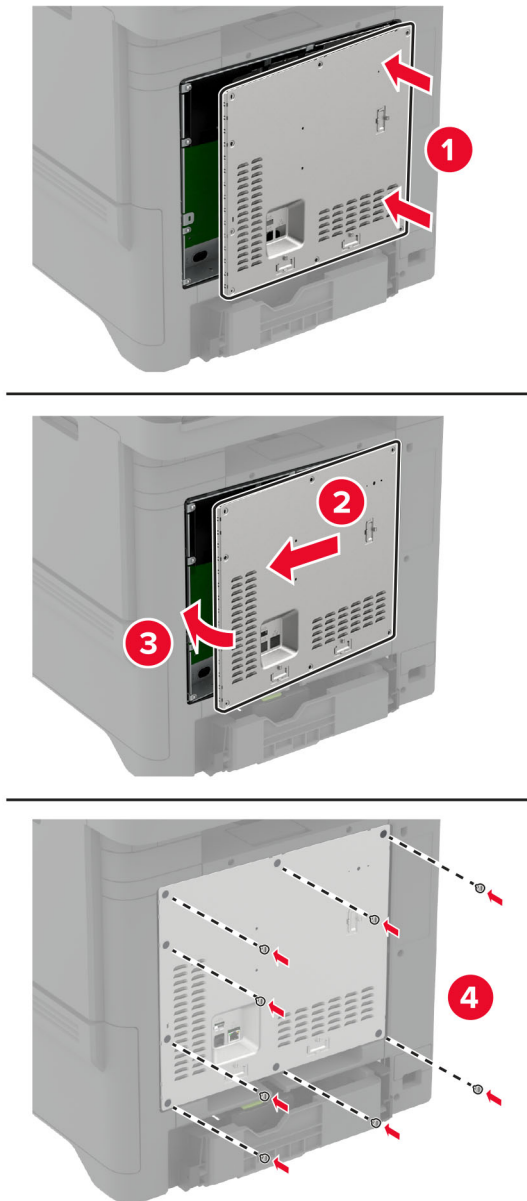
6 Attach the controller board shield.**7** Connect the power cord to the electrical outlet, and then turn on the printer.

⚠ CAUTION—POTENTIAL INJURY: To avoid the risk of fire or electrical shock, connect the power cord to an appropriately rated and properly grounded electrical outlet that is near the product and easily accessible.

Installing the Trusted Platform Module

⚠ CAUTION—SHOCK HAZARD: To avoid the risk of electrical shock, if you are accessing the controller board or installing optional hardware or memory devices sometime after setting up the printer, then turn the printer off, and unplug the power cord from the electrical outlet before continuing. If you have any other devices attached to the printer, then turn them off as well, and unplug any cables going into the printer.

- 1 Turn off the printer, and then unplug the power cord from the electrical outlet.
- 2 Using a flat-head screwdriver, remove the controller board shield.

Warning—Potential Damage: Controller board electronic components are easily damaged by static electricity. Touch a metal surface on the printer before touching any controller board components or connectors.

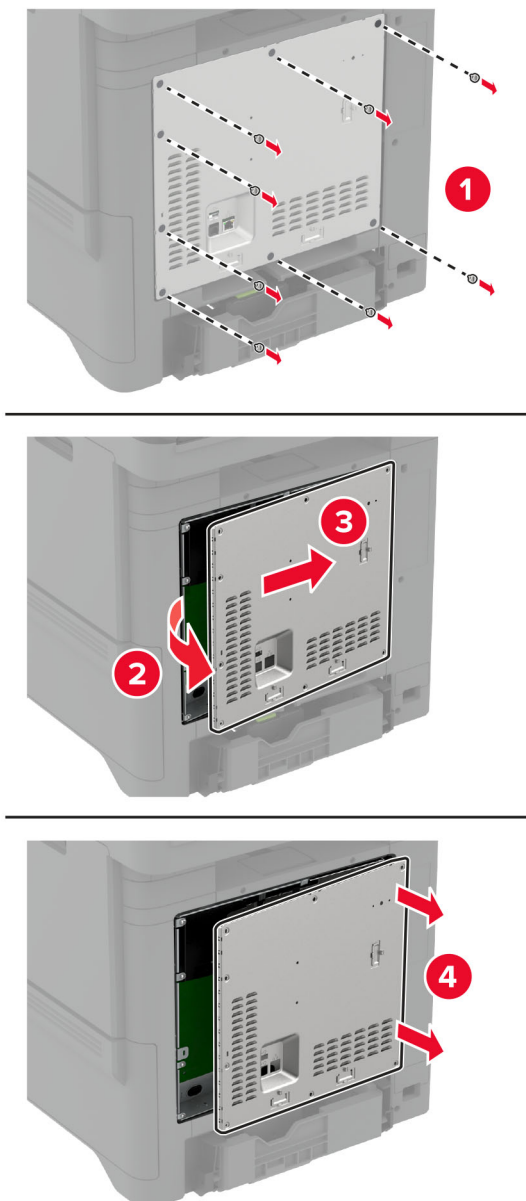

3 Unpack the Trusted Platform Module.

Warning—Potential Damage: Avoid touching the connection points along the edge of the card.

4 Locate the TPM connector.

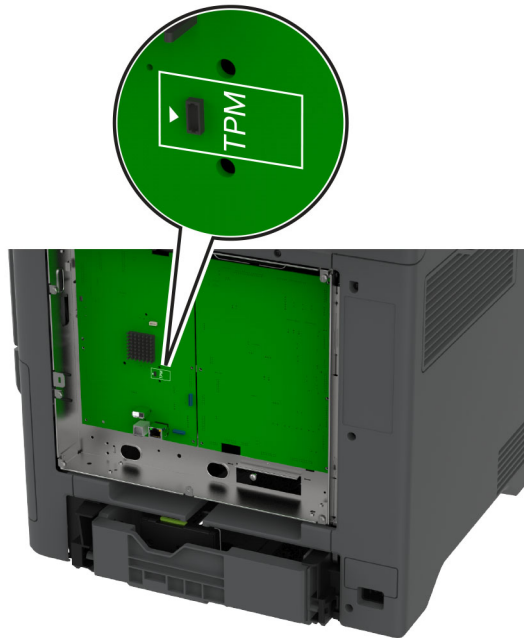

5 Attach the module to the TPM connector.

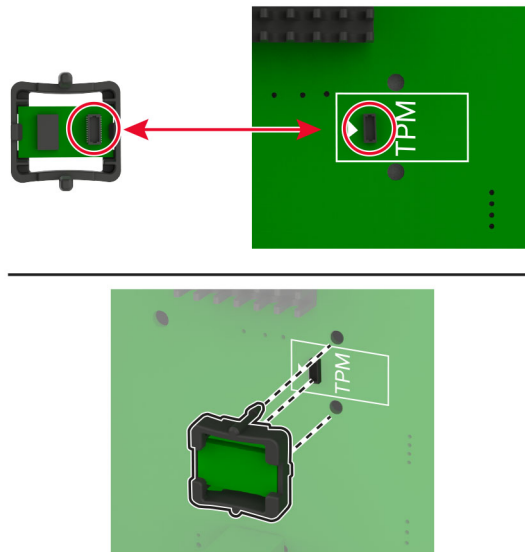

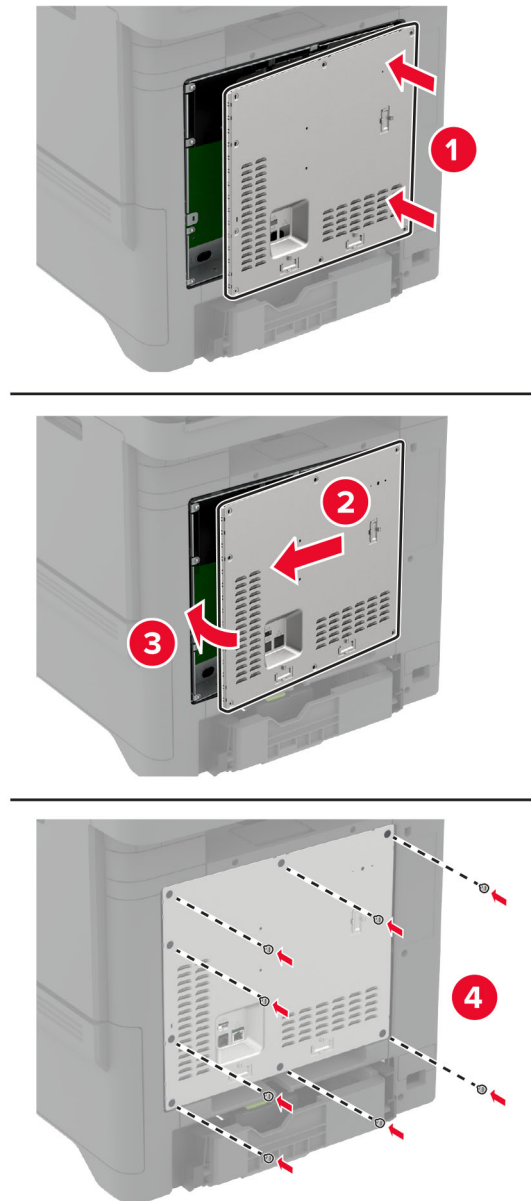
6 Attach the controller board shield.**7** Connect the power cord to the electrical outlet, and then turn on the printer.

⚠ CAUTION—POTENTIAL INJURY: To avoid the risk of fire or electrical shock, connect the power cord to an appropriately rated and properly grounded electrical outlet that is near the product and easily accessible.

Installing the fax card

 **CAUTION—SHOCK HAZARD:** To avoid the risk of electrical shock, if you are accessing the controller board or installing optional hardware or memory devices sometime after setting up the printer, then turn the printer off, and unplug the power cord from the electrical outlet before continuing. If you have any other devices attached to the printer, then turn them off as well, and unplug any cables going into the printer.

 **CAUTION—POTENTIAL INJURY:** To reduce the risk of fire, use only a 26 AWG or larger telecommunications (RJ-11) cord when connecting this product to the public switched telephone network. For users in Australia, the cord must be approved by the Australian Communications and Media Authority.

- 1 Turn off the printer, and then unplug the power cord from the electrical outlet.
- 2 Using a flat-head screwdriver, remove the controller board shield.

Warning—Potential Damage: Controller board electronic components are easily damaged by static electricity. Touch a metal surface on the printer before touching any controller board components or connectors.

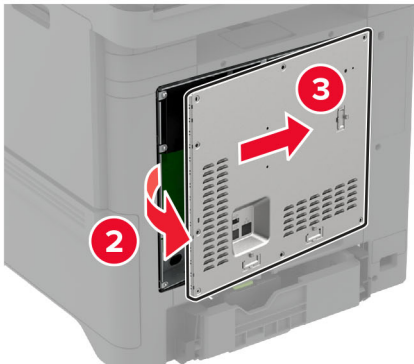
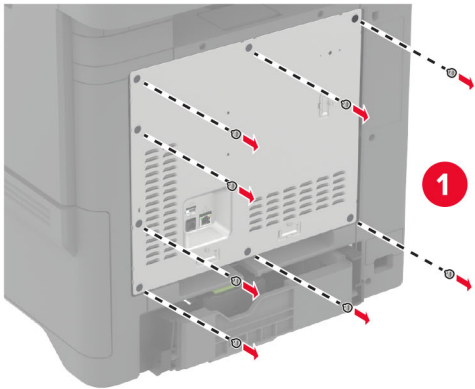

3 Remove the fax cover.

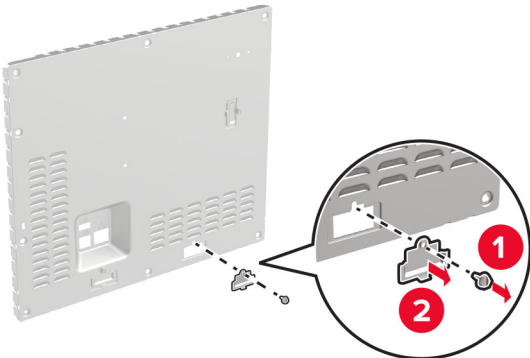

4 If a fax bracket is installed on your printer, then remove it.

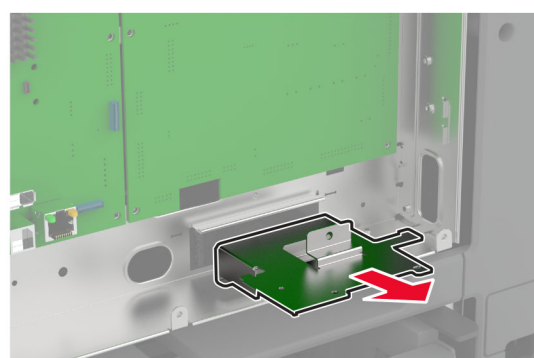
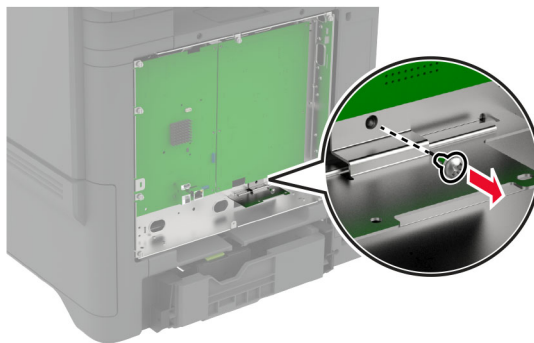

5 Install the fax card to the bracket.

Notes:

- If the fax card came with a bracket, then use that bracket.
- If the fax card does not have a bracket, then use the bracket that you removed in [step 4](#).

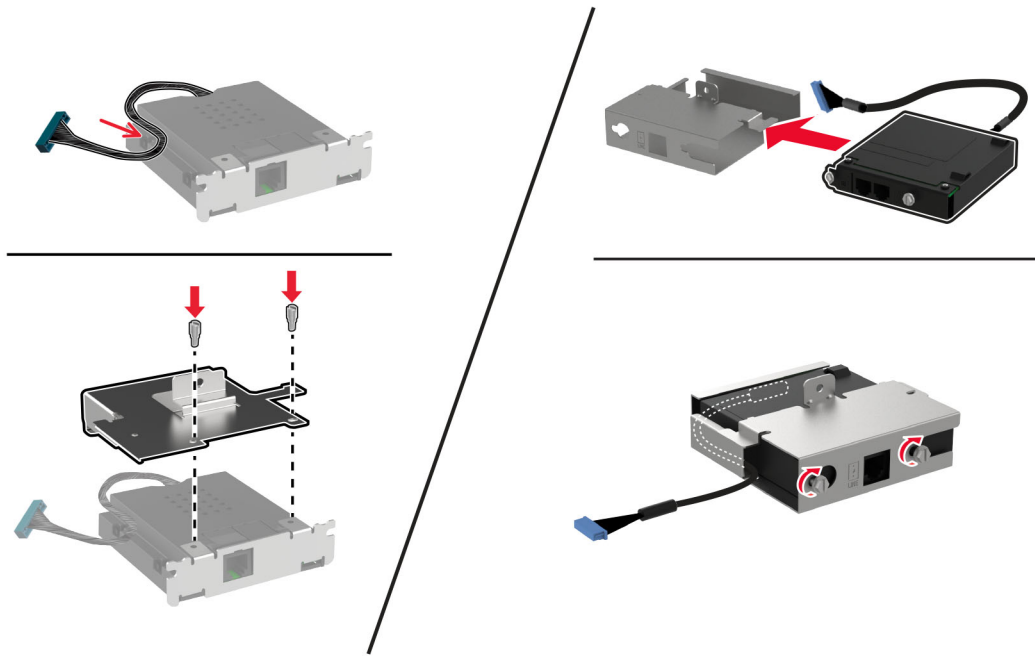

6 Install the fax card to the printer, and then connect the connector to the controller board.

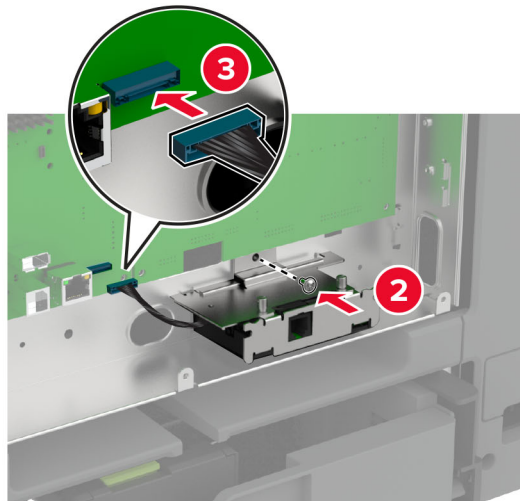
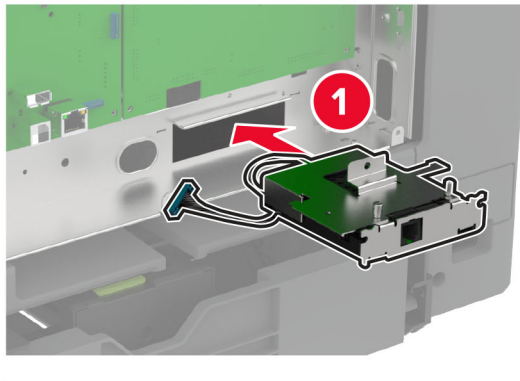

- 7 Attach the controller board shield, and then install the screws.

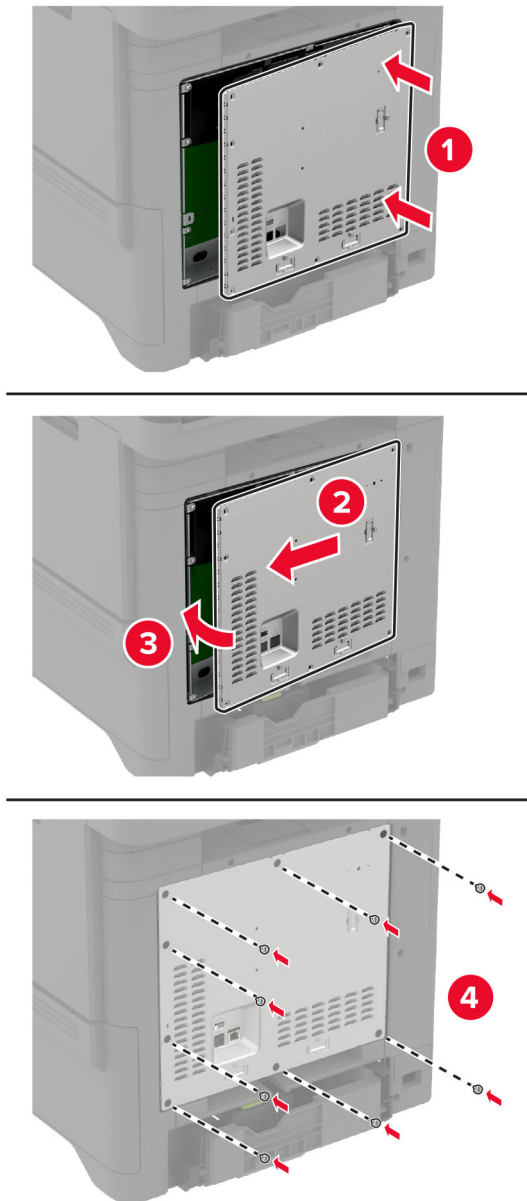

- 8 Connect the power cord to the electrical outlet, and then turn on the printer.

⚠ CAUTION—POTENTIAL INJURY: To avoid the risk of fire or electrical shock, connect the power cord to an appropriately rated and properly grounded electrical outlet that is near the product and easily accessible.

Installing an internal solutions port

⚠ CAUTION—SHOCK HAZARD: To avoid the risk of electrical shock, if you are accessing the controller board or installing optional hardware or memory devices sometime after setting up the printer, then turn the printer off, and unplug the power cord from the electrical outlet before continuing. If you have any other devices attached to the printer, then turn them off as well, and unplug any cables going into the printer.

- 1 Turn off the printer, and then unplug the power cord from the electrical outlet.
- 2 Using a flat-head screwdriver, remove the controller board shield.

Warning—Potential Damage: Controller board electronic components are easily damaged by static electricity. Touch a metal surface on the printer before touching any controller board electronic components or connectors.

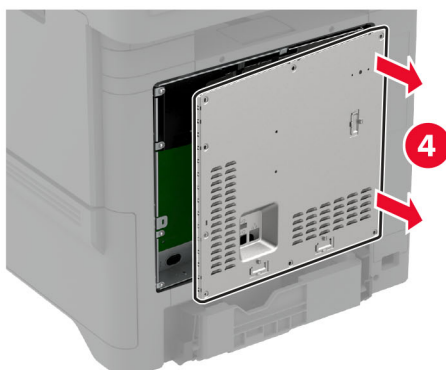
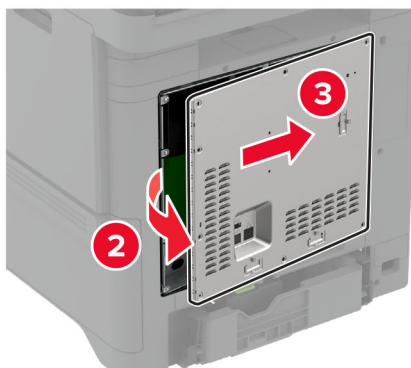
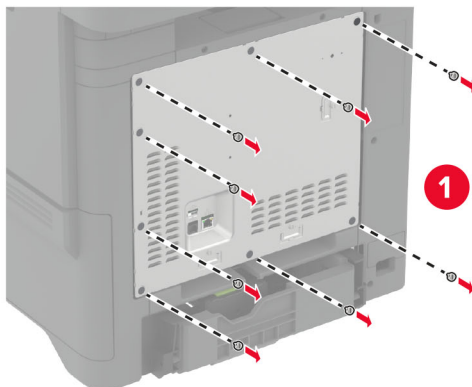

3 Unpack the internal solutions port (ISP) kit.

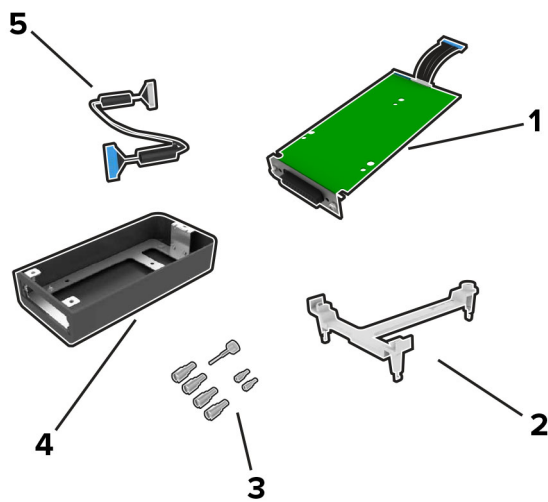

1	ISP
2	Mounting bracket
3	Thumbscrews
4	Housing
5	ISP extended cable

4 Install the ISP into its housing.

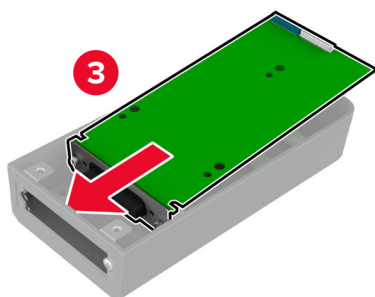
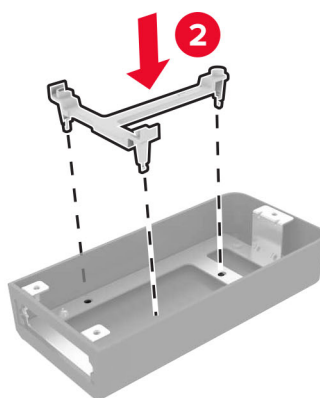
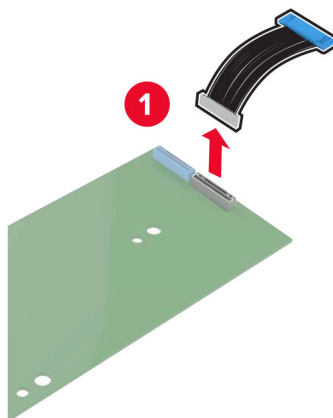

5 Attach the housing to the controller board shield.

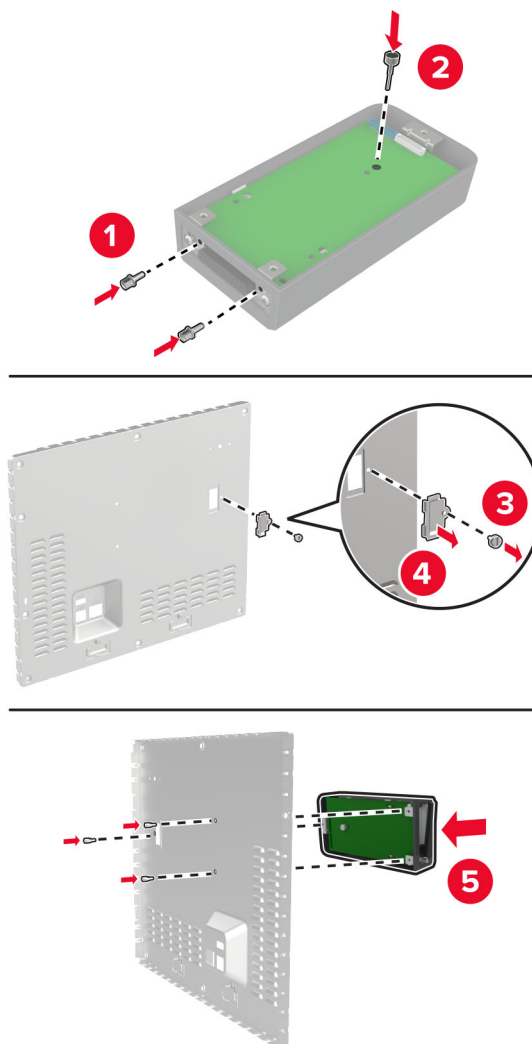

6 Connect the ISP extended cable to the ISP connector in the controller board.

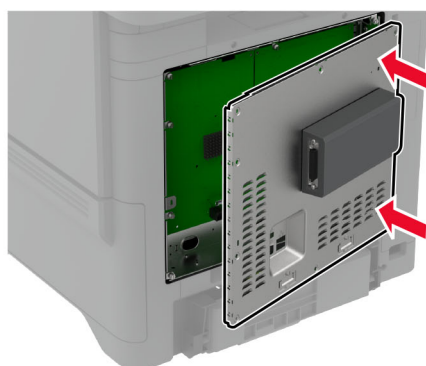
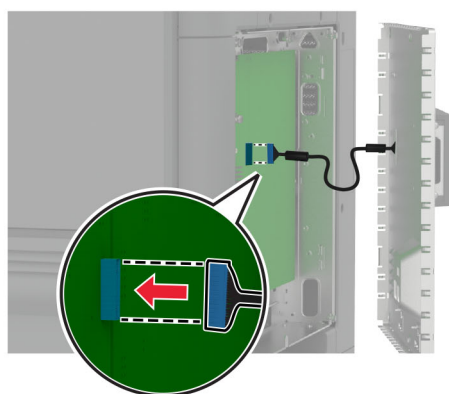
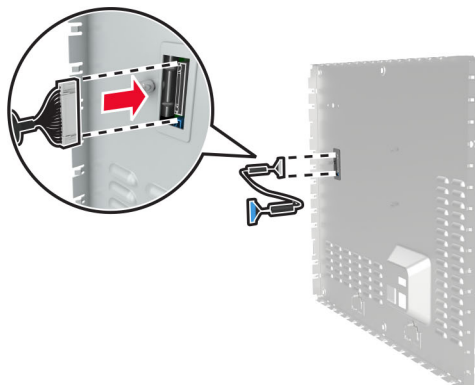

7 Attach the controller board shield.

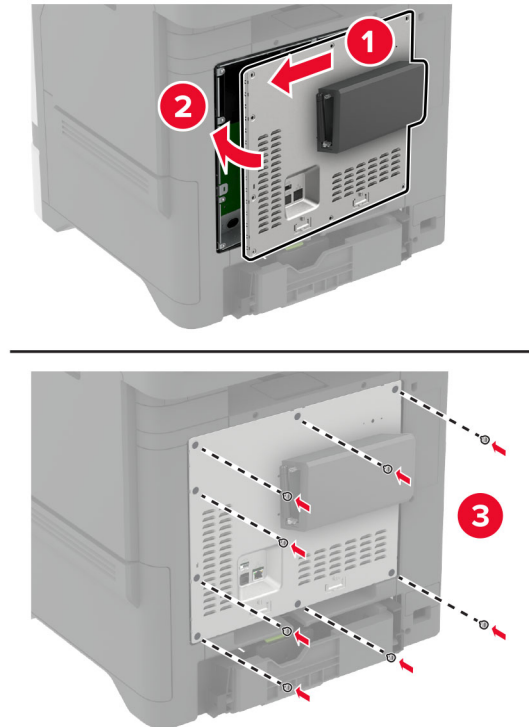

8 Connect the power cord to the electrical outlet, and then turn on the printer.

CAUTION—POTENTIAL INJURY: To avoid the risk of fire or electrical shock, connect the power cord to an appropriately rated and properly grounded electrical outlet that is near the product and easily accessible.

Changing the printer port settings after installing an internal solutions port

Notes:

- If the printer has a static IP address, then do not change the configuration.
- If the computers are configured to use the network name instead of an IP address, then do not change the configuration.
- If you are adding a wireless internal solutions port (ISP) to a printer previously configured for an Ethernet connection, then disconnect the printer from the Ethernet network.

For Windows users

- 1 Open the printers folder.
- 2 From the shortcut menu of the printer with the new ISP, open the printer properties.
- 3 Configure the port from the list.
- 4 Update the IP address.
- 5 Apply the changes.

For Macintosh users

- 1 From System Preferences in the Apple menu, navigate to the list of printers, and then select + > **IP**.
- 2 Type the IP address in the address field.
- 3 Apply the changes.

Installing a printer hard disk

When a hard disk and an intelligent storage drive are both installed, the printer always prioritizes the hard disk to store user data.



CAUTION—SHOCK HAZARD: To avoid the risk of electrical shock, if you are accessing the controller board or installing optional hardware or memory devices sometime after setting up the printer, then turn the printer off, and unplug the power cord from the electrical outlet before continuing. If you have any other devices attached to the printer, then turn them off as well, and unplug any cables going into the printer.

- 1 Turn off the printer, and then unplug the power cord from the electrical outlet.
- 2 Using a flat-head screwdriver, remove the controller board shield.

Warning—Potential Damage: Controller board electronic components are easily damaged by static electricity. Touch a metal surface on the printer before touching any controller board electronic components or connectors.

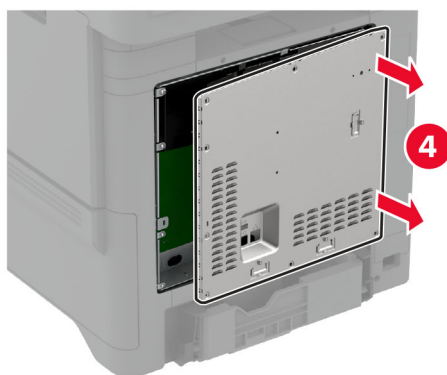
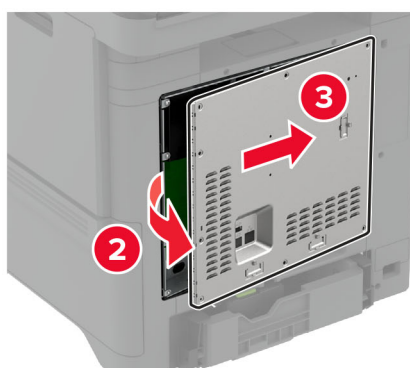
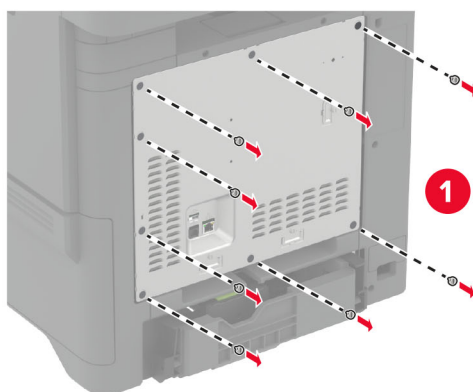

3 Unpack the hard disk.

4 Attach the hard disk to the controller board.

Warning—Potential Damage: Do not touch or press the center of the hard disk.

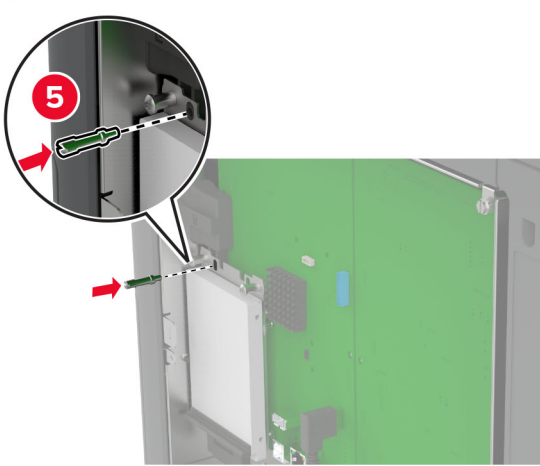
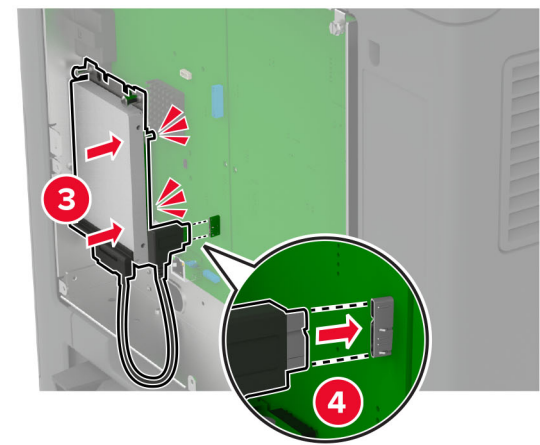
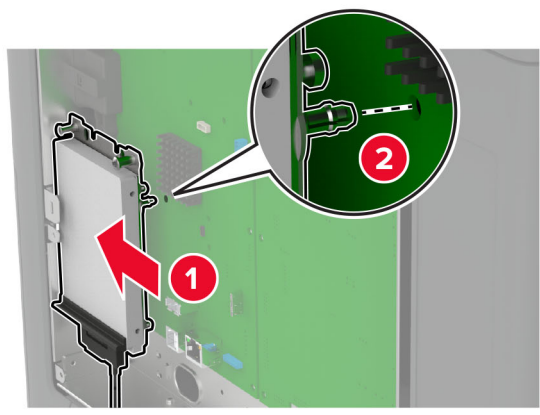

- 5 Attach the controller board shield.

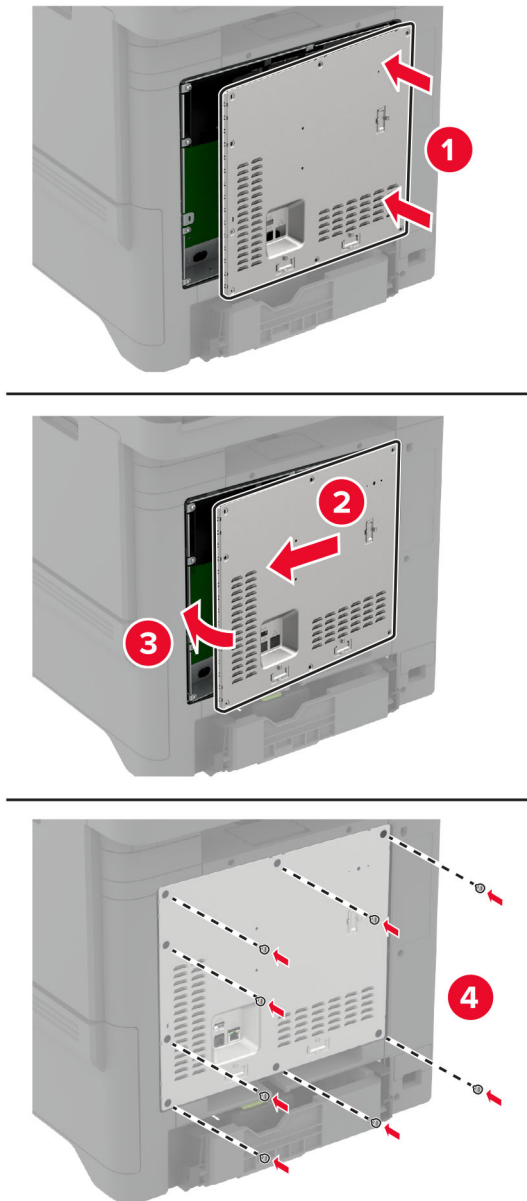

- 6 Connect the power cord to the electrical outlet, and then turn on the printer.

⚠ CAUTION—POTENTIAL INJURY: To avoid the risk of fire or electrical shock, connect the power cord to an appropriately rated and properly grounded electrical outlet that is near the product and easily accessible.

Installing the convenience stapler

- 1 Turn off the printer, and then unplug the power cord from the electrical outlet.
- 2 Unpack the convenience stapler, and then remove all the packing material.

3 Connect the power supply to the convenience stapler.

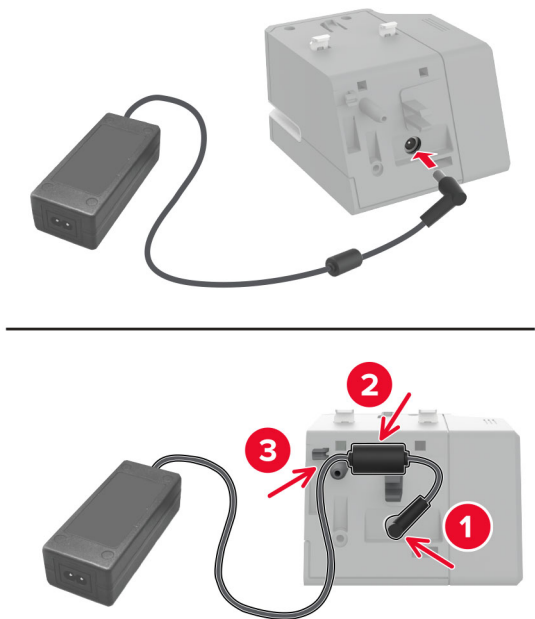

Note: Use only the power supply that came with the convenience stapler. Using any other power supply can damage the product.

4 Attach the cover of the power supply until it *clicks* into place.

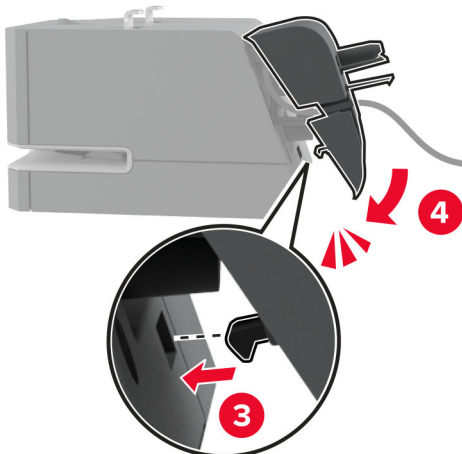
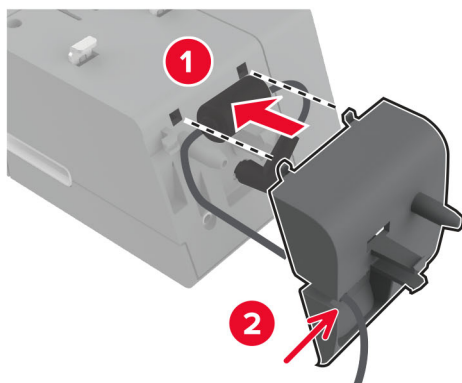

- 5 Install the thumb screw into the cover of the power supply.

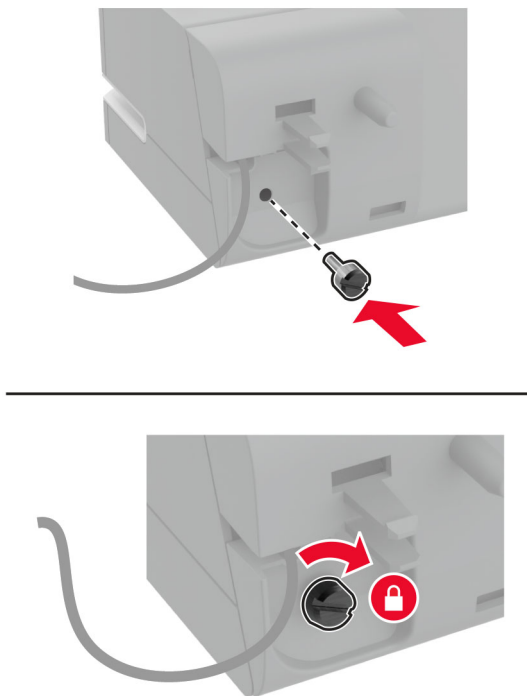

- 6 Remove the column cover above the standard bin.

Note: Make sure that the column cover is disposed properly.

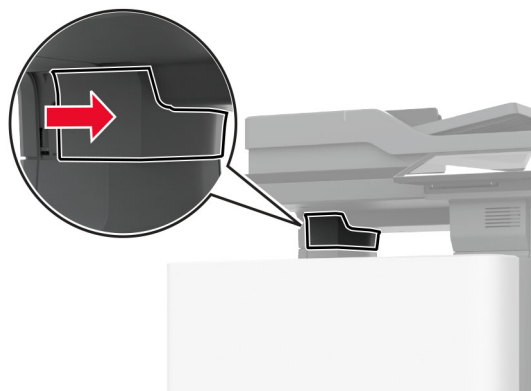

7 Insert the power supply through the printer.

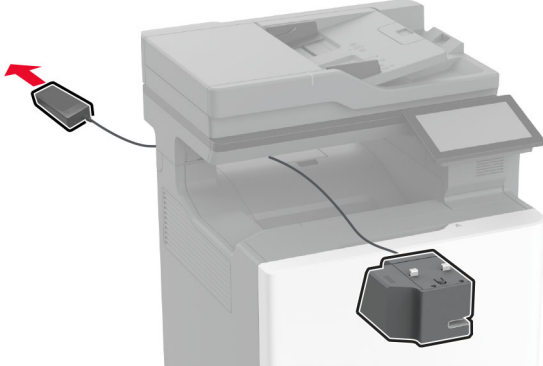

8 Install the convenience stapler.

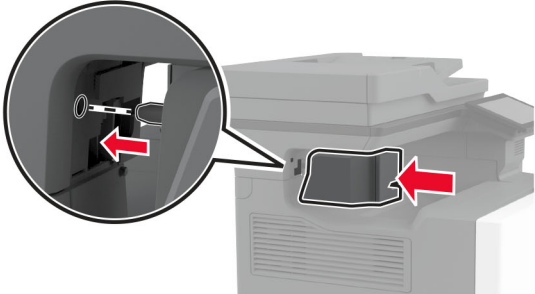
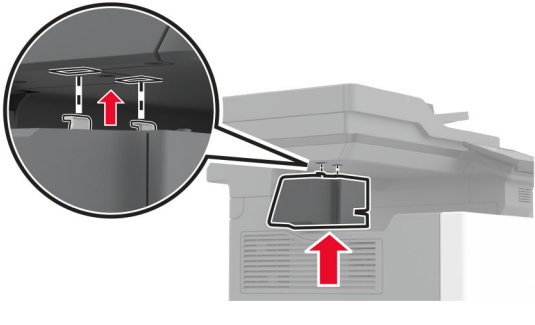

- 9 Position the power supply properly.

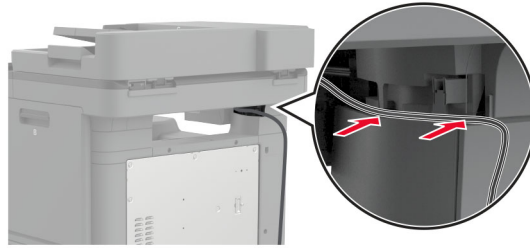

- 10 Attach the stapler cover until it *clicks* into place.

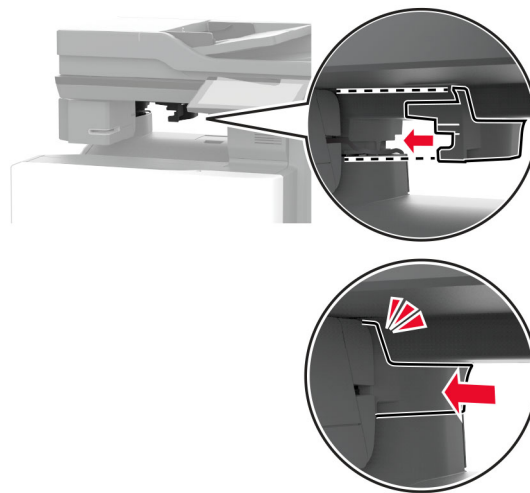

Note: Make sure that the power supply is secured.

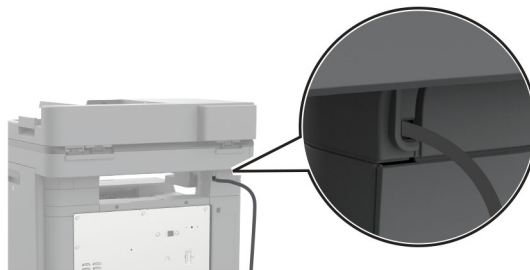

- 11 Connect the stapler and the printer power cords to the electrical outlet, and then turn on the printer.

⚠ CAUTION—POTENTIAL INJURY: To avoid the risk of fire or electrical shock, connect the power cord to an appropriately rated and properly grounded electrical outlet that is near the product and easily accessible.

Installing wireless modules

Installing MarkNet N8370 Wireless Print Server



CAUTION—SHOCK HAZARD: To avoid the risk of electrical shock, if you are accessing the controller board or installing optional hardware or memory devices sometime after setting up the printer, then turn the printer off, and unplug the power cord from the electrical outlet before continuing. If you have any other devices attached to the printer, then turn them off as well, and unplug any cables going into the printer.

- 1 Turn off the printer, and then unplug the power cord from the electrical outlet.
- 2 Using a flat-head screwdriver, remove the controller board shield.

Warning—Potential Damage: Controller board electronic components are easily damaged by static electricity. Touch a metal surface on the printer before touching any controller board electronic components or connectors.

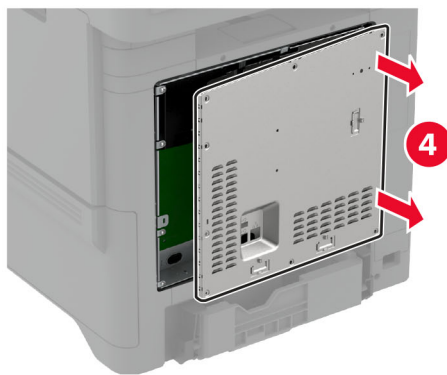
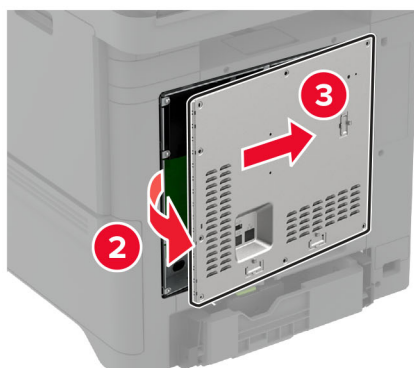
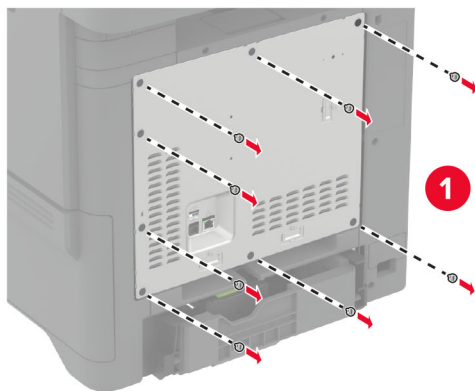

3 Install the wireless module into its housing.

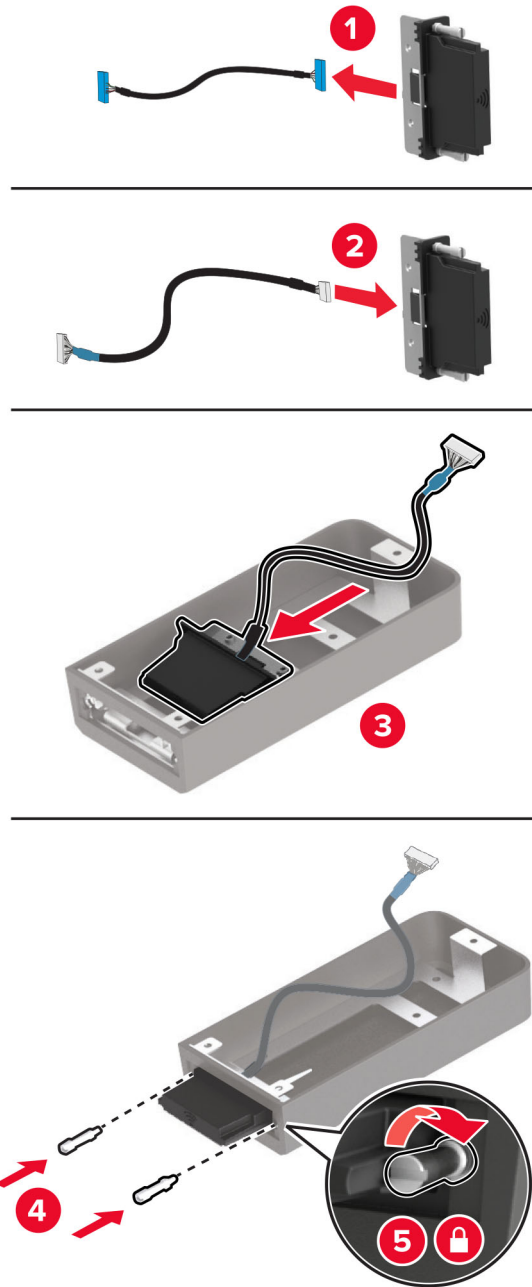

4 Attach the wireless module to the controller board shield.

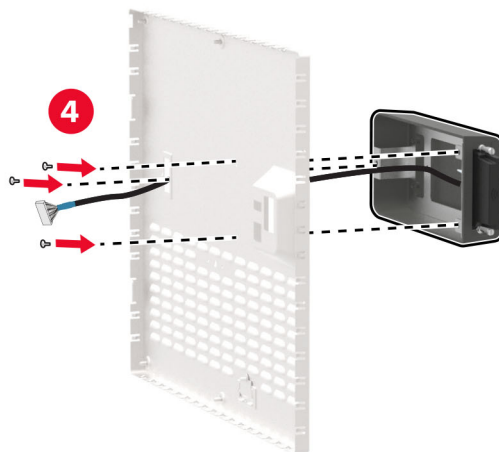
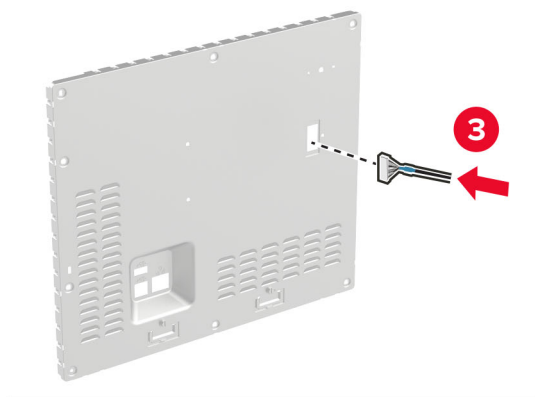
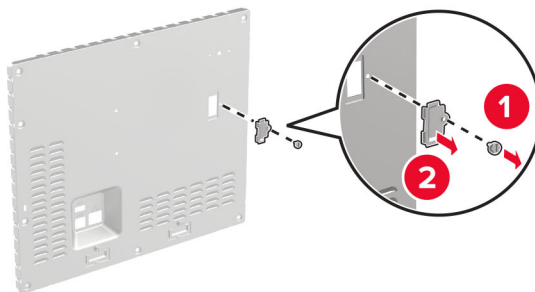

- 5 Connect the wireless assembly to the ISP connector in the controller board.

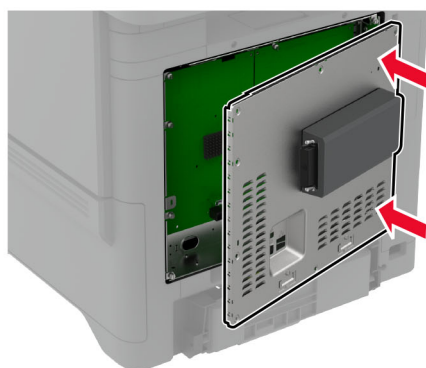
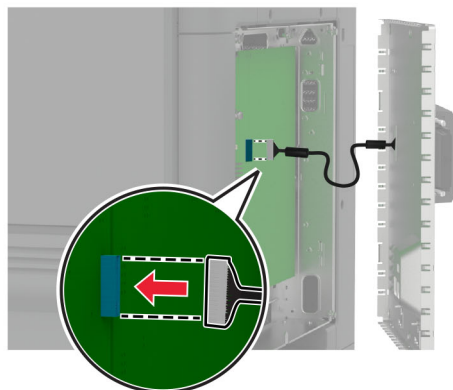

6 Attach the controller board shield.

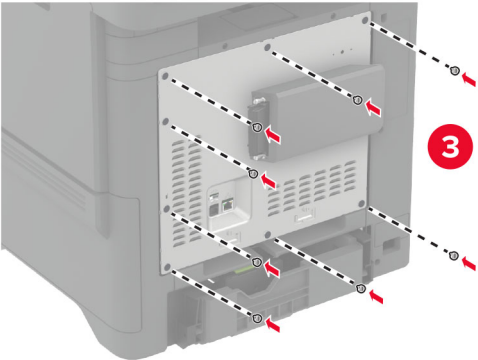
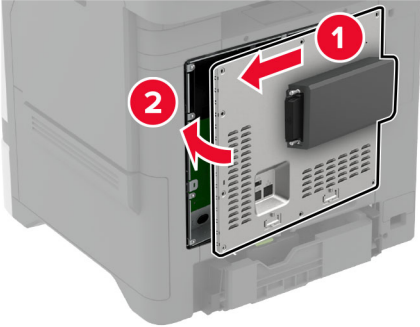

- 7 Attach the NFC card.



- 8 Connect the power cord to the electrical outlet, and then turn on the printer.

⚠ CAUTION—POTENTIAL INJURY: To avoid the risk of fire or electrical shock, connect the power cord to an appropriately rated and properly grounded electrical outlet that is near the product and easily accessible.

Installing MarkNet N8372 Wireless Print Server

- 1 Turn off the printer.
- 2 Apply isopropyl alcohol to a damp, soft, lint-free cloth, and then wipe the surface around the USB port.

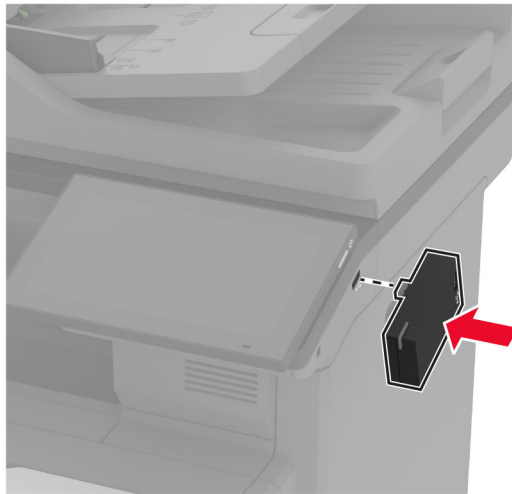
3 Install the wireless module.**Notes:**

- Apply firm pressure to make sure that the tape sticks to the surface of the printer.
- Make sure that the printer surface is dry and free of condensed moisture.
- The module is best bonded to the printer after 72 hours.

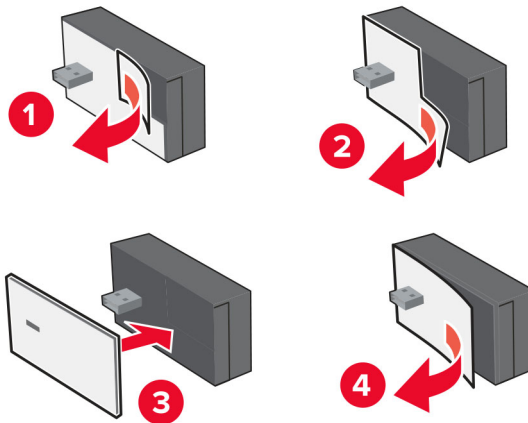
4 Check for a gap between the module and the printer, then attach the spacer module if necessary.

- 5 Attach the NFC card.



- 6 Turn on the printer.

Installing MarkNet N8450 Wireless Print Server

Note: Make sure that the printer is updated to the latest available firmware.

- 1 Turn off the printer, and then unplug the power cord from the electrical outlet.
- 2 Depending on your printer model, locate the wireless print server port.

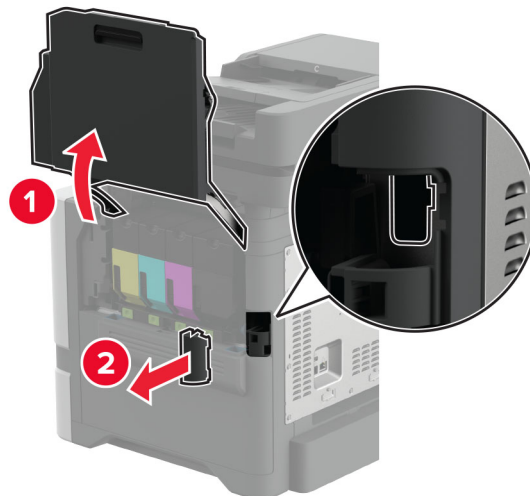

- 3 Insert the wireless print server until it *clicks* into place.

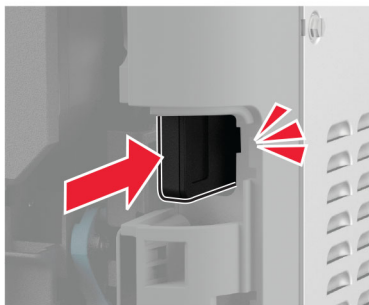
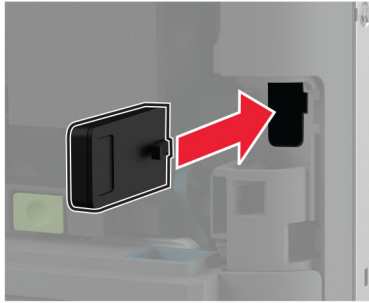

- 4 Depending on your printer model, close the door, attach the port cover, or do both.

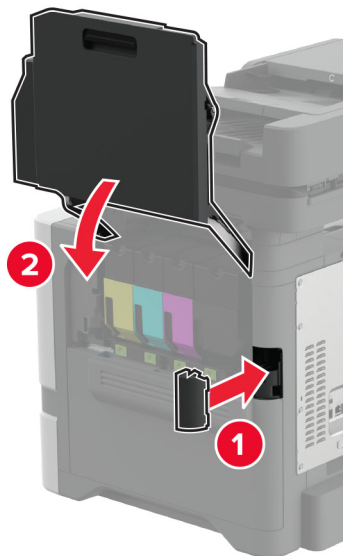

- 5 Connect the power cord to the electrical outlet, and then turn on the printer.

 **CAUTION—POTENTIAL INJURY:** To avoid the risk of fire or electrical shock, connect the power cord to an appropriately rated and properly grounded electrical outlet that is near the product and easily accessible.

Networking

Connecting the printer to a Wi-Fi network

Before you begin, make sure that:

- A wireless module is installed in your printer. For more information, see the [Installing wireless modules](#) section.
- Active Adapter is set to Auto. From the home screen, touch **Settings** > **Network/Ports** > **Network Overview** > **Active Adapter**.

Using the control panel

- 1 From the home screen, touch **Settings** > **Network/Ports** > **Wireless** > **Setup On Printer Panel** > **Choose Network**.
- 2 Select a Wi-Fi network, and then type the network password.

Note: For printers that are Wi-Fi-network-ready, a prompt to set up the Wi-Fi network appears during initial setup.

Using Lexmark Mobile Assistant

- 1 Depending on your mobile device, download the Lexmark Mobile Assistant application from either the App Store or Google Play™.
- 2 From the printer home screen, touch **Settings** > **Network/Ports** > **Wireless** > **Setup Using Mobile App** > **Printer ID**.
- 3 From your mobile device, launch the application, and then accept the Terms of Use.
Note: If necessary, grant permissions.
- 4 Tap **Connect to Printer** > **Go to Wi-Fi Settings**.
- 5 Connect your mobile device to the printer wireless network.
- 6 Return to the application, and then tap **Setup Wi-Fi Connection**.
- 7 Select a Wi-Fi network, and then type the network password.
- 8 Tap **Done**.

Connecting the printer to a wireless network using Wi-Fi Protected Setup (WPS)

Before you begin, make sure that:

- The access point (wireless router) is WPS-certified or WPS-compatible. For more information, see the documentation that came with your access point.
- A wireless module is installed in your printer. For more information, see the [Installing wireless modules](#) section.
- Active Adapter is set to Auto. From the home screen, touch **Settings** > **Network/Ports** > **Network Overview** > **Active Adapter**.

Using the Push-Button method

- 1 From the home screen, touch **Settings > Network/Ports > Wireless > Wi-Fi Protected Setup > Start Push Button Method**.
- 2 Follow the instructions on the display.

Using the personal identification number (PIN) method

- 1 From the home screen, touch **Settings > Network/Ports > Wireless > Wi-Fi Protected Setup > Start PIN Method**.
- 2 Copy the eight-digit WPS PIN.
- 3 Open a web browser, and then type the IP address of your access point in the address field.

Notes:

- To know the IP address, see the documentation that came with your access point.
 - If you are using a proxy server, then temporarily disable it to load the web page correctly.
- 4 Access the WPS settings. For more information, see the documentation that came with your access point.
 - 5 Enter the eight-digit PIN, and then save the changes.

Configuring Wi-Fi Direct

Wi-Fi Direct® allows wireless devices to connect directly to a Wi-Fi Direct-enabled printer without using an access point (wireless router).

Before you begin, make sure that a wireless module is installed on your printer. For more information, see the [Installing wireless modules](#) section.

- 1 From the home screen, touch **Settings > Network/Ports > Wi-Fi Direct**.
- 2 Configure the settings.
 - **Enable Wi-Fi Direct**—Enables the printer to broadcast its own Wi-Fi Direct network.
 - **Wi-Fi Direct Name**—Assigns a name for the Wi-Fi Direct network.
 - **Wi-Fi Direct Password**—Assigns the password for negotiating the wireless security when using the peer-to-peer connection.
 - **Show Password on Setup Page**—Shows the password on the Network Setup Page.
 - **Auto-Accept Push Button Requests**—Lets the printer accept connection requests automatically.

Note: Accepting push-button requests automatically is not secured.

Notes:

- By default, the Wi-Fi Direct network password is not visible on the printer display. To show the password, enable the password peek icon. From the home screen, touch **Settings > Security > Miscellaneous > Enable Password/PIN Reveal**.
- You can see the password of the Wi-Fi Direct network without showing it on the printer display. From the home screen, touch **Settings > Reports > Network > Network Setup Page**.

Connecting a mobile device to the printer

Before connecting your mobile device, make sure that Wi-Fi Direct has been configured. For more information, see [“Configuring Wi-Fi Direct” on page 98](#).

Connecting using Wi-Fi Direct

Note: These instructions apply only to Android mobile devices.

- 1 From the mobile device, go to the settings menu.
- 2 Enable **Wi-Fi**, and then tap **Wi-Fi Direct**.
- 3 Select the printer Wi-Fi Direct name.
- 4 Confirm the connection on the printer control panel.

Connecting using Wi-Fi

- 1 From the mobile device, go to the settings menu.
- 2 Tap **Wi-Fi**, and then select the printer Wi-Fi Direct name.

Note: The string DIRECT-xy (where x and y are two random characters) is added before the Wi-Fi Direct name.

- 3 Enter the Wi-Fi Direct password.

Connecting a computer to the printer

Before connecting your computer, make sure that Wi-Fi Direct has been configured. For more information, see [“Configuring Wi-Fi Direct” on page 98](#).

For Windows users

- 1 Open **Printers & scanners**, and then click **Add a printer or scanner**.
- 2 Click **Show Wi-Fi Direct printers**, and then select the printer Wi-Fi Direct name.
- 3 From the printer display, take note of the eight-digit PIN of the printer.
- 4 Enter the PIN on the computer.

Note: If the print driver is not already installed, then Windows downloads the appropriate driver.

For Macintosh users

- 1 Click the wireless icon, and then select the printer Wi-Fi Direct name.

Note: The string DIRECT-xy (where x and y are two random characters) is added before the Wi-Fi Direct name.

- 2 Type the Wi-Fi Direct password.

Note: Switch your computer back to its previous network after disconnecting from the Wi-Fi Direct network.

Deactivating the Wi-Fi network

- 1 From the home screen, touch **Settings > Network/Ports > Network Overview > Active Adapter > Standard Network**.
- 2 Follow the instructions on the display.

Checking the printer connectivity

- 1 From the home screen, touch **Settings > Reports > Network > Network Setup Page**.
- 2 Check the first section of the network setup page, and confirm that the status is connected.
If the status is not connected, then the LAN drop may be inactive, or the network cable may be malfunctioning. Contact your administrator for assistance.

Setting up serial printing (Windows only)

Before you begin, make sure that a serial internal solutions port is installed in your printer.

- 1 Set the parameters in the printer.
 - a From the control panel, navigate to the menu for the port settings.
 - b Locate the menu for the serial port settings, and then adjust the settings, if necessary.
 - c Apply the changes.
- 2 From your computer, open the printers folder, and then select your printer.
- 3 Open the printer properties, and then select the COM port from the list.
- 4 Set the COM port parameters in Device Manager.

Notes:

- Serial printing reduces printing speed.
- Make sure that the serial cable is connected to the serial port on your printer.

Secure the printer

Locating the security slot

The printer is equipped with a security lock feature. Attach a security lock compatible with most laptop computers in the location shown to secure the printer in place.

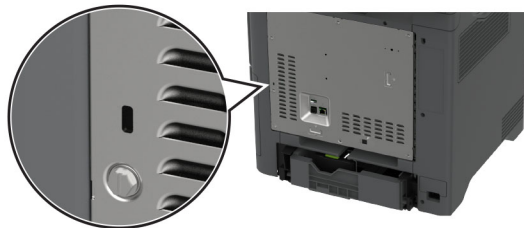

Erasing printer memory

To erase volatile memory or buffered data in your printer, turn off the printer.

To erase nonvolatile memory, device and network settings, security settings, and embedded solutions, do the following:

- 1 From the home screen, touch **Settings > Device > Maintenance > Out of Service Erase**.
- 2 Touch the **Sanitize all information on nonvolatile memory** check box, and then touch **ERASE**.
- 3 Touch **Start initial setup wizard** or **Leave printer offline**, and then touch **Next**.
- 4 Start the operation.

Note: This process destroys the encryption key that is used to protect user data. Format the hard disk and intelligent storage drive after erasing the printer memory.

Erasing printer storage drive

- 1 From the home screen, touch **Settings > Device > Maintenance > Out of Service Erase**.
- 2 Depending on the storage drive that is installed on your printer, do either of the following:
 - For hard disk, touch the **Sanitize all information on hard disk** check box, touch **ERASE**, and then select a method to erase data.

Note: The process to sanitize the hard disk can take from several minutes to more than an hour, making the printer unavailable for other tasks.
 - For intelligent storage drive (ISD), touch **Erase Intelligent Storage Drive**, and then touch **ERASE** to erase all user data.
- 3 Start the operation.

Restoring factory default settings

- 1 From the home screen, touch **Settings** > **Device** > **Restore Factory Defaults**.
- 2 Touch **Restore Settings** > select the settings that you want to restore > **RESTORE**.
- 3 Start the operation.

Statement of Volatility

Type of memory	Description
Volatile memory	The printer uses standard random access memory (RAM) to buffer temporarily user data during simple print and copy jobs.
Nonvolatile memory	The printer may use two forms of non-volatile memory: EEPROM and NAND (flash memory). Both types store the operating system, printer settings, and network information. They also store scanner and bookmark settings and embedded solutions.
Hard disk storage drive	Some printers may have a hard disk drive installed. The printer hard disk is designed for printer-specific functionality. The hard disk lets the printer retain buffered user data from complex print jobs, form data, and font data.
Intelligent storage drive (ISD)	Some printers may have an ISD installed. ISD uses non-volatile flash memory to store user data from complex print jobs, form data, and font data.

Erase the content of any installed printer memory in the following circumstances:

- The printer is decommissioned.
- The printer hard disk or ISD is replaced.
- The printer is moved to a different department or location.
- The printer is serviced by someone from outside your organization.
- The printer is removed from your premises for service.
- The printer is sold to another organization.

Note: To dispose a storage drive, follow the policies and procedures of your organization.

Print

Printing from a computer

Note: For labels, card stock, and envelopes, set the paper size and type in the printer before printing the document.

- 1 From the document that you are trying to print, open the Print dialog.
- 2 If necessary, adjust the settings.
- 3 Print the document.

Printing from a mobile device

Printing from a mobile device using Lexmark Mobile Print

Printing from a mobile device using Lexmark Mobile Print

Lexmark Mobile Print allows you to send documents and images directly to a supported Lexmark printer.

- 1 Open the document, and then send or share the document to Lexmark Mobile Print.

Note: Some third-party applications may not support the send or share feature. For more information, see the documentation that came with the application.

- 2 Select a printer.
- 3 Print the document.

Printing from a mobile device using Lexmark Print

Lexmark Print is a mobile printing solution for mobile devices running on Android™ version 6.0 or later. It lets you send documents and images to network-connected printers and print management servers.

Notes:

- Make sure that you download the Lexmark Print application from the Google Play store and enable it in the mobile device.
- Make sure that the printer and the mobile device are connected to the same network.

- 1 From your mobile device, select a document from the file manager.
- 2 Send or share the document to Lexmark Print.



Note: Some third-party applications may not support the send or share feature. For more information, see the documentation that came with the application.

- 3 Select a printer, and then adjust the settings, if necessary.
- 4 Print the document.

Printing from a mobile device using Mopria Print Service

Mopria® Print Service is a mobile printing solution for mobile devices running on Android version 5.0 or later. It allows you to print directly to any Mopria-certified printer.

Note: Make sure that you download the Mopria Print Service application from the Google Play store and enable it in the mobile device.

- 1 From your Android mobile device, launch a compatible application or select a document from your file manager.
- 2 Tap  > **Print**.
- 3 Select a printer, and then adjust the settings, if necessary.
- 4 Tap .

Printing from a mobile device using AirPrint

The AirPrint software feature is a mobile printing solution that allows you to print directly from Apple devices to an AirPrint-certified printer.



Notes:

- Make sure that the Apple device and the printer are connected to the same network. If the network has multiple wireless hubs, then make sure that both devices are connected to the same subnet.
 - This application is supported only in some Apple devices.
- 1 From your mobile device, select a document from your file manager or launch a compatible application.
 - 2 Tap  > **Print**.
 - 3 Select a printer, and then adjust the settings, if necessary.
 - 4 Print the document.

Printing from a mobile device using Wi-Fi Direct®

Wi-Fi Direct® is a printing service that lets you print to any Wi-Fi Direct-ready printer.

Note: Make sure that the mobile device is connected to the printer wireless network. For more information, see [“Connecting a mobile device to the printer” on page 99](#).

- 1 From your mobile device, launch a compatible application or select a document from your file manager.
- 2 Depending on your mobile device, do one of the following:
 - Tap  > **Print**.
 - Tap  > **Print**.
 - Tap **...** > **Print**.
- 3 Select a printer, and then adjust the settings, if necessary.
- 4 Print the document.

Printing from a flash drive

- 1 Insert the flash drive.

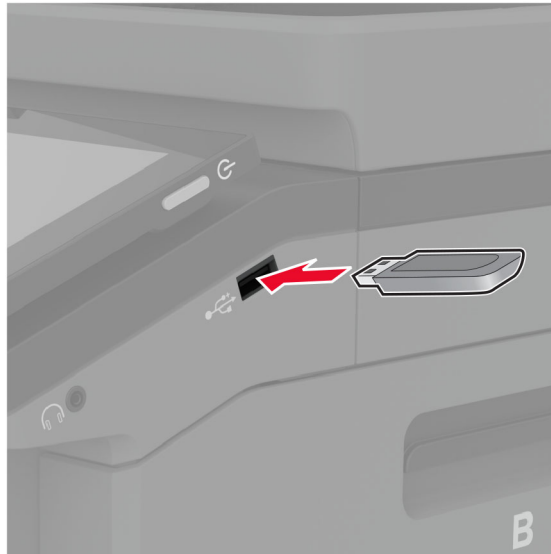

Notes:

- If you insert the flash drive when an error message appears, then the printer ignores the flash drive.
- If you insert the flash drive while the printer is processing other print jobs, then **Busy** appears on the display.

- 2 From the display, touch the document that you want to print.

If necessary, configure the print settings.

- 3 Print the document.

To print another document, touch **USB Drive**.

Warning—Potential Damage: To avoid loss of data or printer malfunction, do not touch the flash drive or the printer in the area shown while actively printing, reading, or writing from the memory device.



Supported flash drives and file types

Flash drives

- Lexar JumpDrive S70 (16GB and 32GB)
- SanDisk Cruzer Micro (16GB and 32GB)
- PNY Attaché (16GB and 32GB)

Notes:

- The printer supports high-speed flash drives with full-speed standard.
- Flash drives must support the File Allocation Table (FAT) system.

File types

Documents	Images
<ul style="list-style-type: none"> • PDF (version 1.7 or earlier) • Microsoft file formats (DOC, DOCX, XLS, XLSX, PPT, PPTX) 	<ul style="list-style-type: none"> • JPEG or JPG • TIFF or TIF • GIF • BMP • PNG • PCX • DCX

Configuring confidential jobs

- 1 From the home screen, touch **Settings** > **Security** > **Confidential Print Setup**.
- 2 Configure the settings.

Setting	Description
Max Invalid PIN	Set the limit for entering an invalid PIN. Note: When the limit is reached, the print jobs for that user name are deleted.
Confidential Job Expiration	Set an individual expiration time for each held job before it is automatically deleted from the printer memory, hard disk, or intelligent storage drive. Note: A held job is either Confidential, Repeat, Reserve, or Verify.
Repeat Job Expiration	Set the expiration time for print jobs that you want to repeat.
Verify Job Expiration	Set the expiration time for printing a copy of a job for you to check its quality before printing the remaining copies.
Reserve Job Expiration	Set the expiration time for jobs that you want to store in the printer for printing later.
Require All Jobs to be Held	Set the printer to hold all print jobs.
Keep duplicate documents	Set the printer to keep all documents with the same file name.

Printing confidential and other held jobs

For Windows users

- 1 With a document open, click **File > Print**.
- 2 Select a printer, and then click **Properties, Preferences, Options, or Setup**.
- 3 Click **Print and Hold**.
- 4 Select **Use Print and Hold**, and then assign a user name.
- 5 Select the print job type (Confidential, Repeat, Reserve, or Verify).
If you select **Confidential**, then secure the print job with a personal identification number (PIN).
- 6 Click **OK** or **Print**.
- 7 From the printer home screen, release the print job.
 - For confidential print jobs, touch **Held jobs** > select your user name > **Confidential** > enter the PIN > select the print job > configure the settings > **Print**.
 - For other print jobs, touch **Held jobs** > select your user name > select the print job > configure the settings > **Print**.

For Macintosh users

Using AirPrint

- 1 With a document open, choose **File > Print**.
- 2 Select a printer, and then from the drop-down menu following the Orientation menu, choose **PIN Printing**.
- 3 Enable **Print with PIN**, and then enter a four-digit PIN.

- 4 Click **Print**.
- 5 From the printer home screen, release the print job. Touch **Held jobs** > select your computer name > **Confidential** > enter the PIN > select the print job > **Print**.

Using the print driver

- 1 With a document open, choose **File** > **Print**.
- 2 Select a printer, and then from the drop-down menu following the Orientation menu, choose **Print and Hold**.
- 3 Choose **Confidential Print**, and then enter a four-digit PIN.
- 4 Click **Print**.
- 5 From the printer home screen, release the print job. Touch **Held jobs** > select your computer name > **Confidential** > select the print job > enter the PIN > **Print**.

Printing a font sample list

- 1 From the home screen, touch **Settings** > **Reports** > **Print** > **Print Fonts**.
- 2 Touch **PCL Fonts** or **PS Fonts**.

Printing a directory list

From the home screen, touch **Settings** > **Reports** > **Print** > **Print Directory**.

Placing separator sheets between copies

- 1 From the home screen, touch **Settings** > **Print** > **Layout** > **Separator Sheets** > **Between Copies**.
- 2 Print the document.

Canceling a print job

- 1 From the home screen, touch .
- 2 Select the job to cancel.



Note: You can also cancel a job by touching **Job Queue**.

Adjusting toner darkness

- 1 From the home screen, touch **Settings** > **Print** > **Quality**.
- 2 In the Toner Darkness menu, adjust the settings.

Copy

Using the automatic document feeder and scanner glass

Automatic document feeder (ADF)	Scanner glass
 <ul style="list-style-type: none"> • Use the ADF for multiple-page or two-sided documents. • Load an original document faceup. For multiple-page documents, make sure to align the leading edge before loading. • Make sure to adjust the ADF guides to match the width of the paper that you are loading. 	 <ul style="list-style-type: none"> • Use the scanner glass for single-page documents, book pages, small items (such as postcards or photos), transparencies, photo paper, or thin media (such as magazine clippings). • Place the document facedown in the corner with the arrow.

Making copies

- 1 Load an original document into the ADF tray or on the scanner glass.

Note: To avoid a cropped image, make sure that the original document and output have the same paper size.

- 2 From the home screen, touch **Copy**, and then specify the number of copies.
If necessary, adjust the copy settings.
- 3 Copy the document.

Note: To make a quick copy, from the home screen, touch .

Copying photos

- 1 Place a photo on the scanner glass.
- 2 From the home screen, touch **Copy** > **Content** > **Content Type** > **Photo**.
- 3 Touch **Content Source**, and then select the setting that best matches the original photo.
- 4 Copy the photo.

Copying on letterhead

- 1 Load an original document into the ADF tray or on the scanner glass.
- 2 From the home screen, touch **Copy** > **Copy From** > select the size of the original document.
- 3 Touch **Copy To**, and then select the paper source that contains the letterhead.
If you loaded the letterhead into the multipurpose feeder, then touch **Copy To** > **Multipurpose Feeder** > select a paper size > **Letterhead**.
- 4 Copy the document.

Copying on both sides of the paper

- 1 Load an original document into the ADF tray or on the scanner glass.
- 2 From the home screen, touch **Copy** > **Sides**.
- 3 Touch **1 sided to 2 sided** or **2 sided to 2 sided**.
- 4 Copy the document.

Reducing or enlarging copies

- 1 Load an original document into the ADF tray or on the scanner glass.
- 2 From the home screen, touch **Copy** > **Scale** > select a scale value.
Note: Changing the size of the original document or output after setting Scale restores the scale value to Auto.
- 3 Copy the document.

Collating copies

- 1 Load an original document into the ADF tray or on the scanner glass.
- 2 From the home screen, touch **Copy** > **Collate** > **On [1,2,1,2,1,2]**.
- 3 Copy the document.

Placing separator sheets between copies

- 1 Load an original document into the ADF tray or on the scanner glass.
- 2 From the home screen, touch **Copy** > **Separator Sheets**.
- 3 Adjust the settings.
- 4 Send the copy job.

Copying multiple pages onto a single sheet

- 1 Load an original document into the ADF tray or on the scanner glass.
- 2 From the home screen, touch **Copy** > **Pages per Side**.
- 3 Adjust the settings.
- 4 Copy the document.

Copying cards



- 1 Load a card on the scanner glass.
- 2 From the home screen, touch **Copy** > **Copy From**.
- 3 Touch **ID Card**.
- 4 Copy the card.

Creating a copy shortcut

- 1 From the home screen, touch **Copy**.
- 2 Configure the settings, and then touch .
- 3 Create a shortcut.

E-mail

Using the automatic document feeder and scanner glass

Automatic document feeder (ADF)	Scanner glass
 <ul style="list-style-type: none"> • Use the ADF for multiple-page or two-sided documents. • Load an original document faceup. For multiple-page documents, make sure to align the leading edge before loading. • Make sure to adjust the ADF guides to match the width of the paper that you are loading. 	 <ul style="list-style-type: none"> • Use the scanner glass for single-page documents, book pages, small items (such as postcards or photos), transparencies, photo paper, or thin media (such as magazine clippings). • Place the document facedown in the corner with the arrow.

Sending an e-mail

Before you begin, make sure that the SMTP settings are configured. For more information, see [“Configuring the e-mail SMTP settings” on page 40](#).



- 1 Load an original document into the ADF tray or on the scanner glass.
- 2 From the home screen, touch **E-mail**, and then enter the needed information.
- 3 If necessary, configure the scan settings.
- 4 Send the e-mail.

Creating an e-mail shortcut

- 1 From the home screen, touch **E-mail**.
- 2 Configure the settings, and then touch .
- 3 Create a shortcut.

Fax

Using the automatic document feeder and scanner glass

Automatic document feeder (ADF)	Scanner glass
 <ul style="list-style-type: none"> • Use the ADF for multiple-page or two-sided documents. • Load an original document faceup. For multiple-page documents, make sure to align the leading edge before loading. • Make sure to adjust the ADF guides to match the width of the paper that you are loading. 	 <ul style="list-style-type: none"> • Use the scanner glass for single-page documents, book pages, small items (such as postcards or photos), transparencies, photo paper, or thin media (such as magazine clippings). • Place the document facedown in the corner with the arrow.

Sending a fax

Note: Make sure that fax is configured. For more information, see the [Setting up the printer to fax](#) section.

Using the control panel

- 1 Load an original document into the ADF tray or on the scanner glass.
- 2 From the home screen, touch **Fax**, and then enter the needed information.
If necessary, adjust the settings.
- 3 Send the fax.

Using the computer

Before you begin, make sure that the fax driver is installed. For more information, see [“Installing the fax driver” on page 55](#).

For Windows users

- 1 From the document that you are trying to fax, open the Print dialog.
- 2 Select the printer, and then click **Properties**, **Preferences**, **Options**, or **Setup**.
- 3 Click **Fax** > **Enable fax** > **Always display settings prior to faxing**, and then enter the recipient number.
If necessary, configure other fax settings.
- 4 Send the fax.

For Macintosh users

- 1 With a document open, choose **File > Print**.
- 2 Select the printer that has - **Fax** added after its name.
- 3 In the To field, enter the recipient number.
If necessary, configure other fax settings.
- 4 Send the fax.

Scheduling a fax

Note: Make sure that fax is configured. For more information, see the [Setting up the printer to fax](#) section.

- 1 Load an original document into the ADF tray or on the scanner glass.
- 2 From the home screen, touch **Fax > To >** enter the fax number **> Done**.
- 3 Touch **Send Time**, configure the date and time, and then touch **OK**.
- 4 Send the fax.

Creating a fax destination shortcut

Note: Make sure that fax is configured. For more information, see the [Setting up the printer to fax](#) section.

- 1 From the home screen, touch **Fax > To**.
- 2 Enter the recipient number, and then touch **Done**.
- 3 Configure the settings, and then touch .
- 4 Create a shortcut.

Changing the fax resolution

Note: Make sure that fax is configured. For more information, see the [Setting up the printer to fax](#) section.

- 1 Load an original document into the ADF tray or on the scanner glass.
- 2 From the home screen, touch **Fax**, and then enter the needed information.
- 3 Touch **Resolution**, and then select a setting.
- 4 Send the fax.

Adjusting the fax darkness

Note: Make sure that fax is configured. For more information, see the [Setting up the printer to fax](#) section.

- 1 Load an original document into the ADF tray or on the scanner glass.
- 2 From the home screen, touch **Fax**, and then enter the needed information.

- 3 Touch **Darkness**, and then adjust the setting.
- 4 Send the fax.

Printing a fax log

Note: Make sure that analog fax or etherFAX is configured. For more information, see the [Setting up the printer to fax](#) section.

- 1 From the home screen, touch **Settings > Reports > Fax**.
- 2 Touch **Fax Job Log** or **Fax Call Log**.

Blocking junk faxes

Note: Make sure that analog fax or etherFAX is configured. For more information, see the [Setting up the printer to fax](#) section.

- 1 From the home screen, touch **Settings > Fax > Fax Setup > Fax Receive Settings > Admin Controls**.
- 2 Set Block No Name Fax to **On**.

Holding faxes

Note: Make sure that analog fax or etherFAX is configured. For more information, see the [Setting up the printer to fax](#) section.

- 1 From the home screen, touch **Settings > Fax > Fax Setup > Fax Receive Settings > Holding Faxes**.
- 2 Select a mode.

Forwarding a fax

Note: Make sure that analog fax or etherFAX is configured. For more information, see the [Setting up the printer to fax](#) section.

- 1 Create a destination shortcut.
 - a Open a web browser, and then type the printer IP address in the address field.

Notes:

 - View the printer IP address on the home screen. The IP address appears as four sets of numbers separated by periods, such as 123.123.123.123.
 - If you are using a proxy server, then temporarily disable it to load the web page correctly.
 - b Click **Shortcuts > Add Shortcut**.
 - c Select a shortcut type, and then configure the settings.

Note: Take note of the shortcut number.
 - d Apply the changes.
- 2 Click **Settings > Fax > Fax Setup > Fax Receive Settings > Admin Controls**.

- 3** In the Fax Forwarding menu, select **Forward** or **Print and Forward**.
- 4** In the Forward to menu, select the destination type and then type the shortcut number.
- 5** Apply the changes.

Scan

Using the automatic document feeder and scanner glass

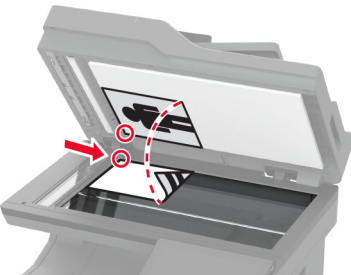
Automatic document feeder (ADF)	Scanner glass
 <ul style="list-style-type: none"> • Use the ADF for multiple-page or two-sided documents. • Load an original document faceup. For multiple-page documents, make sure to align the leading edge before loading. • Make sure to adjust the ADF guides to match the width of the paper that you are loading. 	 <ul style="list-style-type: none"> • Use the scanner glass for single-page documents, book pages, small items (such as postcards or photos), transparencies, photo paper, or thin media (such as magazine clippings). • Place the document facedown in the corner with the arrow.

Scanning to a computer

Before you begin, make sure that the computer and the printer are connected to the same network.

For Windows users

Using Lexmark ScanBack Utility

- 1 From the computer, run Lexmark ScanBack Utility, and then click **Next**.

Note: To download the utility, go to www.lexmark.com/downloads.

- 2 Click **Setup**, and then add the printer IP address.

Note: View the printer IP address on the printer home screen. The IP address appears as four sets of numbers separated by periods, such as 123.123.123.123.

- 3 Click **Close > Next**.

- 4 Select the size of the original document, and then click **Next**.

- 5 Select a file format and scan resolution, and then click **Next**.

- 6 Type a unique scan profile name, and then click **Next**.

- 7 Browse to the location you want to save the scanned document, create a file name, and then click **Next**.

Note: To reuse the scan profile, enable **Create Shortcut**, and then create a unique shortcut name.

- 8 Click **Finish**.

- 9 Load an original document into the automatic document feeder or on the scanner glass.
- 10 From the printer home screen, touch **Scan Profiles** > **Scan to Computer**, and then select a scan profile.

Using Windows Fax and Scan

Note: Make sure that the printer is added to the computer. For more information, see [“Adding printers to a computer” on page 55](#).

- 1 Load an original document into the automatic document feeder or on the scanner glass.
- 2 From the computer, open **Windows Fax and Scan**.
- 3 From the Source menu, select a scanner source.
- 4 If necessary, change the scan settings.
- 5 Scan the document.

For Macintosh users

Note: Make sure that the printer is added to the computer. For more information, see [“Adding printers to a computer” on page 55](#).

- 1 Load an original document into the automatic document feeder or on the scanner glass.
- 2 From the computer, do either of the following:
 - Open **Image Capture**.
 - Open **Printers & Scanners**, and then select a printer. Click **Scan** > **Open Scanner**.
- 3 From the Scanner window, do one or more of the following:
 - Select where you want to save the scanned document.
 - Select the size of the original document.
 - To scan from the ADF, select **Document Feeder** from the Scan Menu or enable **Use Document Feeder**.
 - If necessary, configure the scan settings.
- 4 Click **Scan**.

Scanning to an FTP server

- 1 Load the original document into the ADF tray or on the scanner glass.
- 2 From the home screen, touch **FTP**, and then enter the needed information.
- 3 If necessary, configure other FTP settings.
- 4 Send the FTP job.

Creating an FTP shortcut

- 1 From the home screen, touch **FTP**.
- 2 Enter the FTP server address, and then touch .
- 3 Create a shortcut.

Scanning to a network folder

- 1 Load the document into the ADF tray or on the scanner glass.
- 2 From the home screen, touch **Scan Center**.
Note: The icon and name may have been changed. For more information, contact your administrator.
- 3 Do either of the following:
 - Select a destination.
Note: For SFTP, set the port number to **22**.
 - Use a shortcut by touching ★, and then selecting the shortcut from the list.
- 4 Scan the document.

Creating a network folder shortcut

- 1 Open a web browser, and then type the printer IP address in the address field.
Notes:
 - View the printer IP address on the printer home screen. The IP address appears as four sets of numbers separated by periods, such as 123.123.123.123.
 - If you are using a proxy server, then temporarily disable it to load the web page correctly.
- 2 Click **Shortcuts > Add Shortcut**.
- 3 From the Shortcut Type menu, select **Network Folder**, and then configure the settings.
- 4 Apply the changes.

Scanning to a flash drive

- 1 Load an original document into the ADF tray or on the scanner glass.
- 2 Insert the flash drive.

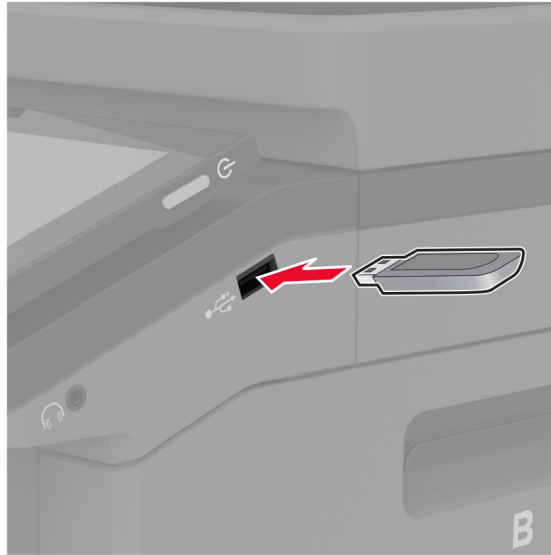

- 3 Touch **Scan to USB** and adjust the settings if necessary.

Notes:

- To save the scanned document to a folder, touch **Scan to**, select a folder, and then touch **Scan Here**.
- If the USB Drive screen does not appear, then touch **USB Drive** on the control panel.

- 4 Scan the document.

Warning—Potential Damage: To avoid loss of data or printer malfunction, do not touch the flash drive or the printer in the area shown while actively printing, reading, or writing from the memory device.



Use printer menus

Menu map

Device	<ul style="list-style-type: none"> • Preferences • Eco-Mode • Remote Operator Panel • Notifications • Power Management • Anonymous Data Collection 	<ul style="list-style-type: none"> • Accessibility • Restore Factory Defaults • Maintenance • Home Screen Customization • Update firmware • About this Printer
Print	<ul style="list-style-type: none"> • Layout • Setup • Quality • Job Accounting 	<ul style="list-style-type: none"> • PDF • PostScript • PCL • Image
Paper	<ul style="list-style-type: none"> • Tray Configuration 	<ul style="list-style-type: none"> • Media Configuration
Copy	Copy Defaults	
Fax	Fax Defaults	
E-mail	<ul style="list-style-type: none"> • E-mail Setup • E-mail Defaults 	<ul style="list-style-type: none"> • Web Link Setup
FTP	FTP Defaults	
USB Drive	<ul style="list-style-type: none"> • Flash Drive Scan 	<ul style="list-style-type: none"> • Flash Drive Print
Network/Ports	<ul style="list-style-type: none"> • Network Overview • Wireless • Wi-Fi Direct • Mobile Services Management • Ethernet • TCP/IP • SNMP 	<ul style="list-style-type: none"> • IPSec • 802.1x • LPD Configuration • HTTP/FTP Settings • ThinPrint • USB • Restrict external network access
Security	<ul style="list-style-type: none"> • Login Methods • Schedule USB Devices • Security Audit Log • Login Restrictions • Confidential Print Setup 	<ul style="list-style-type: none"> • Disk Encryption • Erase Temporary Data Files • Solutions LDAP Settings • Miscellaneous
Cloud Services	Cloud Services Enrollment	
Reports	<ul style="list-style-type: none"> • Menu Settings Page • Device • Print 	<ul style="list-style-type: none"> • Shortcuts • Fax • Network
Troubleshooting	Print Quality Test Pages	Cleaning the Scanner

Device

Preferences

Menu item	Description
Display Language [List of languages]	Set the language of the text that appears on the display.
Country/Region [List of countries or regions]	Identify the country or region where the printer is configured to operate.
Run initial setup Off* On	Run the setup wizard.
Keyboard Keyboard Type [List of languages]	Select a language as a keyboard type. Note: All the Keyboard Type values may not appear or may require special hardware to appear.
Displayed information Display Text 1 (IP Address*) Display Text 2 (Date/Time*) Custom Text 1 Custom Text 2	Specify the information to appear on the home screen.
Date and Time Configure Current Date and Time Manually Set Date and Time Date Format (MM-DD-YYYY*) Time Format (12 hour A.M./P.M.*) Time Zone (UTC-5:00*) Network Time Protocol Enable NTP (On*) NTP Server Enable Authentication (None*)	Configure the printer date and time and network time protocol.
Paper Sizes U.S.* Metric	Specify the unit of measurement for paper sizes. Note: The country or region selected in the initial setup wizard determines the initial paper size setting.
Screen Brightness 20–100% (100*)	Adjust the brightness of the display.
Flash Drive Access Disabled Enabled*	Enable access to the flash drive.
Note: An asterisk (*) next to a value indicates the factory default setting.	

Menu item	Description
Allow Background Removal Off On*	Specify whether background removal is allowed.
Allow Custom Job scans Off On*	Specify whether the Custom Job Scanning setting appears for copy, scan, and fax. Note: This menu item appears only when a hard disk or an intelligent storage drive is installed.
One Page Flatbed Scanning Off* On	Set the printer to scan any type of job involving the scanner glass as a single page. Note: The printer returns to the home screen after performing a single flatbed scan instead of displaying prompts.
Device Sounds Mute All Sounds (Off*) Button Feedback (On*) Volume (5*) ADF Loaded Beep (On*) Alarm Control (Single*) Cartridge Alarm (Single*) Speaker Mode (Always Off*) Ringer Volume (Off*)	Configure the sound settings of the printer.
Screen Timeout 5–300 seconds (60*)	Set the idle time in seconds before the display shows the home screen, or before the printer logs out a user account automatically.
Note: An asterisk (*) next to a value indicates the factory default setting.	

Eco-Mode

Menu item	Description
Print Sides 1-Sided* 2-Sided	Specify whether to print on one side or both sides of the paper.
Note: An asterisk (*) next to a value indicates the factory default setting.	

Menu item	Description
Print Pages per Side Off* 2 pages per side 3 pages per side 4 pages per side 6 pages per side 9 pages per side 12 pages per side 16 pages per side	Print multiple page images on one side of a sheet of paper.
Print Toner Darkness 1–5 (4*)	Determine the lightness or darkness of text images.
Print Color Saver Off* On	Reduce the amount of toner used to print graphics and images.
Copy Sides 1 sided to 1 sided* 1 sided to 2 sided 2 sided to 1 sided 2 sided to 2 sided	Specify the scanning behavior based on the original document.
Copy Pages per Side Off* 2 Portrait pages 4 Portrait pages 2 Landscape pages 4 Landscape pages	Specify the scanning behavior based on the original document.
Copy Darkness 1–9 (5*)	Determine the darkness of the scanned text images.
Note: An asterisk (*) next to a value indicates the factory default setting.	

Remote Operator Panel

Menu item	Description
External VNC Connection Don't Allow* Allow	Connect an external Virtual Network Computing (VNC) client to the remote control panel.
Note: An asterisk (*) next to a value indicates the factory default setting.	

Menu item	Description
Authentication Type None* Standard Authentication	Set the authentication type when accessing the VNC client server.
VNC Password	Specify the password to connect to the VNC client server. Note: This menu item appears only if Authentication Type is set to Standard Authentication.
Note: An asterisk (*) next to a value indicates the factory default setting.	

Notifications

Menu item	Description
ADF Loaded Beep Off On*	Enable a sound when loading paper into the ADF.
Alarm Control Off Single* Continuous	Set the number of times that the alarm sounds when the printer requires user intervention.
Supplies Show Supply Estimates Show estimates* Do not show estimates	Show the estimated status of the supplies.
Supplies Cartridge Alarm Off Single* Continuous	Set the number of times that the alarm sounds when the cartridge is low.
Supplies Custom Supply Notifications	Configure notification settings when the printer requires user intervention. Note: This menu item appears only in the Embedded Web Server.
E-mail Alerts Setup E-mail Setup Primary SMTP Gateway	Type the IP address or host name of the primary SMTP server for sending e-mail.
E-mail Alerts Setup E-mail Setup Primary SMTP Gateway Port (25*)	Enter the port number of the primary SMTP server.
E-mail Alerts Setup E-mail Setup Secondary SMTP Gateway	Type the server IP address or host name of your secondary or backup SMTP server.
Note: An asterisk (*) next to a value indicates the factory default setting.	

Menu item	Description
E-mail Alerts Setup E-mail Setup Secondary SMTP Gateway Port (25*)	Enter the server port number of your secondary or backup SMTP server.
E-mail Alerts Setup E-mail Setup SMTP Timeout (30*)	Specify how long before the printer times out if the SMTP server does not respond.
E-mail Alerts Setup E-mail Setup Reply Address	Specify a reply address in the e-mail.
E-mail Alerts Setup E-mail Setup Always use SMTP default Reply Address (Off*)	Use the SMTP default Reply Address.
E-mail Alerts Setup E-mail Setup Use SSL/TLS (Disabled*)	Send an e-mail using an encrypted link.
E-mail Alerts Setup E-mail Setup Require Trusted Certificate (On*)	Require a trusted certificate when accessing the SMTP server.
E-mail Alerts Setup E-mail Setup SMTP Server Authentication (No authentication required*)	Set the authentication type for the SMTP server.
E-mail Alerts Setup E-mail Setup Device-Initiated E-mail (None*)	Set whether credentials are required for device-initiated e-mails.
E-mail Alerts Setup E-mail Setup User-Initiated E-mail (None*)	Set whether credentials are required for user-initiated e-mails.
E-mail Alerts Setup E-mail Setup Use Active Directory Device Credentials (Off*)	Enable user credentials and group designations to connect to the SMTP server.
E-mail Alerts Setup E-mail Setup Device Userid	Specify the user ID to connect to the SMTP server.
E-mail Alerts Setup E-mail Setup Device Password	Specify the password to connect to the SMTP server.

Note: An asterisk (*) next to a value indicates the factory default setting.

Menu item	Description
E-mail Alerts Setup E-mail Setup Kerberos 5 REALM	Specify the realm for the Kerberos 5 authentication protocol.
E-mail Alerts Setup E-mail Setup NTLM Domain	Specify the domain name for the NTLM security protocol.
E-mail Alerts Setup E-mail Setup Disable "SMTP server not set up" error (Off*)	Disable an SMTP setup error message to appear on the display.
Error Prevention ADF Multifeed Sensor Off On*	Detect when the ADF picks more than one sheet of media at once.
Error Prevention Jam Assist Off On*	Set the printer to check for jammed paper automatically.
Error Prevention Auto Continue Off On* Auto Continue Time (5*)	Let the printer continue processing or printing a job automatically after clearing certain attendance conditions.
Error Prevention Auto Reboot Auto Reboot Reboot when idle Reboot always* Reboot never	Set the printer to restart when an error occurs.
Error Prevention Auto Reboot Max Auto Reboots (2*)	Set the number of automatic reboots that the printer can perform.
Error Prevention Auto Reboot Auto Reboot Window (720*)	Set the number of seconds before the printer performs an automatic reboot.
Error Prevention Auto Reboot Auto Reboot Counter	Show a read-only information of the reboot counter.
Note: An asterisk (*) next to a value indicates the factory default setting.	

Menu item	Description
Error Prevention Auto Reboot Reset Auto Reboot Counter Cancel Continue	Reset Auto Reboot Counter.
Error Prevention Display Short Paper Error On Auto-clear*	Set the printer to show a message when a short paper error occurs. Note: Short paper refers to the size of the paper loaded.
Error Prevention Page Protect Off* On	Set the printer to process the entire page into the memory before printing it.
Jam Content Recovery Jam Recovery Off On Auto*	Set the printer to reprint jammed pages.
Jam Content Recovery Scanner Jam Recovery Job level Page level*	Specify how to restart a scan job after resolving a paper jam.
Note: An asterisk (*) next to a value indicates the factory default setting.	

Power Management

Menu item	Description
Sleep Mode Profile Print from Sleep Mode Stay awake after printing Enter Sleep Mode after printing*	Set the printer to stay awake or enter Sleep mode after printing.
Sleep Mode Profile Touch to Wake from Deep Sleep Off On*	Wake the printer from Deep Sleep mode by touching the printer display.
Timeouts Sleep Mode 1–114 minutes (15*)	Set the idle time before the printer begins operating in Sleep mode.
Note: An asterisk (*) next to a value indicates the factory default setting.	

Menu item	Description
Timeouts Hibernate Timeout Disabled 1 hour 2 hours 3 hours 6 hours 1 day 2 days 3 days* 1 week 2 weeks 1 month	Set the time before the printer turns off.
Timeouts Hibernate Timeout on Connection Hibernate Do Not Hibernate*	Set Hibernate Timeout to turn off the printer while an active Ethernet connection exists.
Schedule Power Modes Schedules Add New Schedule	Schedule the printer when to enter Sleep or Hibernate mode.
Note: An asterisk (*) next to a value indicates the factory default setting.	

Anonymous Data Collection

Menu item	Description
Anonymous Data Collection Device Usage and Performance Information None*	Send printer usage and performance information to Lexmark. Note: Anonymous Data Send Time appears only when you set Anonymous Data Collection to Device Usage and Performance Information.
Anonymous Data Send Time Start Time Stop Time	
Note: An asterisk (*) next to a value indicates the factory default setting.	

Accessibility

Menu item	Description
Duplicate Key Strike Interval 0–5 (0*)	Set the interval in seconds during which the printer ignores duplicate key presses on an attached keyboard.
Note: An asterisk (*) next to a value indicates the factory default setting.	

Menu item	Description
Key Repeat Initial Delay 0.25–5 (1*)	Set the initial length of delay in seconds before a repeating key starts repeating. Note: This menu item appears only when a keyboard is attached to the printer.
Key Repeat Rate 0.5–30 (30*)	Set the number of presses per second for a repeating key. Note: This menu item appears only when a keyboard is attached to the printer.
Prolong Screen Timeout Off* On	Let the user remain in the same location and reset the Screen Timeout timer when it expires instead of returning to the home screen.
Headphone Volume 1–10 (5*)	Adjust the headphone volume. Note: This menu item appears only when a headphone is attached to the printer.
Enable Voice Guidance When Headphone Is Attached Off* On	Enable Voice Guidance when a headphone is attached to the printer.
Speak Passwords/PINs Off* On	Set the printer to read out loud passwords or personal identification numbers. Note: This menu item appears only when a headphone or a speaker is attached to the printer.
Speech Rate Very Slow Slow Normal* Fast Faster Very Fast Rapid Very Rapid Fastest	Set the Voice Guidance speech rate. Note: This menu item appears only when a headphone or a speaker is attached to the printer.
Note: An asterisk (*) next to a value indicates the factory default setting.	

Restore Factory Defaults

Menu item	Description
Restore Settings Restore all settings Restore printer settings Restore network settings Restore fax settings Restore app settings	Restore the printer factory default settings.

Maintenance

Configuration Menu

Menu item	Description
USB Configuration USB PnP 1* 2	Change the USB driver mode of the printer to improve its compatibility with a personal computer.
USB Configuration USB Scan to Local On* Off	Set whether the USB device driver enumerates as a USB Simple device (single interface) or as a USB Composite device (multiple interfaces).
USB Configuration USB Speed Full Auto*	Set the USB port to run at full speed and disable its high-speed capabilities.
Tray Configuration Size Sensing Tray [x] Sensing Off On*	Set the tray to sense automatically the paper size loaded into it.
Tray Configuration Tray Linking Automatic* Off	Set the printer to link the trays that have the same paper type and paper size settings.
Tray Configuration Show Tray Insert Message Off Only for unknown sizes* Always	Display a message that lets the user change the paper size and paper type settings after inserting the tray.
Tray Configuration A5 Loading Short Edge Long Edge*	Determine the default loading orientation for the A5 size paper in all paper sources.
Tray Configuration Paper Prompts Auto* Multipurpose Feeder Manual Paper	Set the paper source that the user fills when a prompt to load paper appears. Note: For Multipurpose Feeder to appear, in the Paper menu, set Configure MP to Cassette.
Note: An asterisk (*) next to a value indicates the factory default setting.	

Menu item	Description
Tray Configuration Envelope Prompts Auto* Multipurpose Feeder Manual Envelope	Set the paper source that the user fills when a prompt to load envelope appears. Note: For Multipurpose Feeder to appear, in the Paper menu, set Configure MP to Cassette.
Tray Configuration Action for Prompts Prompt user* Continue Use current	Set the printer to resolve paper- or envelope-related change prompts.
Tray Configuration Multiple Universal Sizes Off* On	Set the tray to support multiple universal paper sizes.
Reports Menu Settings Page Event Log Event Log Summary	Print reports about printer menu settings, status, and event logs.
Supply Usage And Counters Clear Supply Usage History	Reset the supply usage history, such as number of pages and days remaining, to the factory shipped level.
Supply Usage And Counters ITM Reset Reset Black Cartridge Counter Reset Cyan Cartridge Counter Reset Magenta Cartridge Counter Reset Yellow Cartridge Counter Reset Maintenance Counter	Reset the counter after installing a new supply item or maintenance kit.
Supply Usage And Counters Tiered Coverage Ranges	Adjust the amount of color coverage for each printing range.
Printer Emulations PPDS Emulation Off* On	Set the printer to recognize and use the PPDS data stream.
Printer Emulations PS Emulation Off On*	Set the printer to recognize and use the PS data stream.
Printer Emulations Enable Formsmerge Off* On	Activate formsmerge to store the forms into the hard disk or intelligent storage drive (ISD). Note: The printer must have a hard disk or an ISD installed.
Note: An asterisk (*) next to a value indicates the factory default setting.	

Menu item	Description
Printer Emulations Enable Prescribe Off* On	Activate Prescribe. Note: The Prescribe license must be installed.
Printer Emulations Emulator Security Page Timeout 0–60 (60*)	Set the page timeout during emulation.
Printer Emulations Emulator Security Reset Emulator After Job Off* On	Reset the emulator after a print job.
Printer Emulations Emulator Security Disable Printer Message Access Off On*	Disable access to printer message during emulation.
Fax Configuration Fax Low Power Support Disable Sleep Permit Sleep Auto*	Set fax to enter Sleep mode whenever the printer determines that it must.
Fax Configuration Fax Storage Location NAND Disk*	Set the storage location for all faxes. Note: This menu item appears only when a hard disk or an ISD is installed.
Print Configuration Black Only Mode Off* On	Print non-copy jobs in grayscale.
Print Configuration Color Trapping Off 1 2* 3 4 5	Enhance the printed output to compensate for misregistration in the printer.
Note: An asterisk (*) next to a value indicates the factory default setting.	

Menu item	Description
Print Configuration Font Sharpening 0–150 (24*)	Set a text point-size value below which the high-frequency screens are used when printing font data. For example, if the value is 24, then all fonts sized 24 points or less use the high-frequency screens.
Device Operations Quiet Mode Off* On	Set the printer to operate in Quiet Mode. Note: Enabling this setting slows down the overall performance of the printer.
Device Operations Panel Menus Off On*	Enable access to the printer menus from the control panel.
Device Operations Safe Mode Off* On	Set the printer to operate in a special mode, in which it attempts to continue offering as much functionality as possible, despite known issues. For example, when set to On, and the duplex motor is nonfunctional, the printer performs one-sided printing of the documents even if the job is two-sided printing.
Device Operations Minimum Copy Memory 80 MB* 100 MB	Set the minimum memory allocation for storing copy jobs.
Device Operations Clear Custom Status	Erase user-defined strings for the Default or Alternate custom messages.
Device Operations Clear all remotely-installed messages	Erase messages that were remotely installed.
Device Operations Automatically Display Error Screens Off On*	Show existing error messages on the display after the printer remains inactive on the home screen for a length of time.
Device Operations Honor orientation on fast path copy Off* On	Enable the printer to use the orientation setting under the Copy menu when sending quick copy jobs.
Toner patch sensor setup Calibration frequency preference Disabled Fewest color adjustments Fewer color adjustments Normal* Better color accuracy Best color accuracy	Set how often color calibration and color alignment is performed.
Note: An asterisk (*) next to a value indicates the factory default setting.	

Menu item	Description
Toner patch sensor setup Full calibration	Run the full color calibration.
Toner patch sensor setup Print TPS information page	Print a diagnostic page that contains information on toner patch sensor calibration.
App Configuration LES Applications Off On*	Enable Lexmark Embedded Solutions (LES) applications.
Scanner Configuration Scanner Manual Registration Print Quick Test	Print a Quick Test target page. Note: Make sure that the margin spacing on the target page is uniform all the way around the target. If it is not, then the printer margins must be reset.
Scanner Configuration Scanner Manual Registration Front ADF Registration Rear ADF Registration Flatbed Registration	Manually register the flatbed and ADF after replacing the ADF, scanner glass, or controller board.
Scanner Configuration Reset Maintenance Counter	Reset the counter after replacing the ADF maintenance kit.
Scanner Configuration Edge Erase Flatbed Edge Erase (3*) ADF Edge Erase (3*)	Set the size, in millimeters, of the no-print area around an ADF or flatbed scan job.
Scanner Configuration ADF Deskew ADF Electronic Deskew (On*)	Reduce skewing of documents that are scanned from the ADF.
Scanner Configuration Disable Scanner No* Yes ADF Only	Disable the scanner when it is not working properly.
Scanner Configuration Tiff Byte Order CPU Endianness* Little Endian Big Endian	Set the byte order of a TIFF-formatted scan output.
Scanner Configuration Exact Tiff Rows Per Strip On* Off	Set the RowsPerStrip tag value of a TIFF-formatted scan output.
Note: An asterisk (*) next to a value indicates the factory default setting.	

Menu item	Description
Scanner Configuration Scanner Glass Cleaning Threshold 1000–30000, 0=Disabled (10000*)	Set the number of scans before the user receives a prompt to clean the scanner glass.
Note: An asterisk (*) next to a value indicates the factory default setting.	

Out of Service Erase

Menu item	Description
Out of Service Erase Memory Last Sanitized Hard Disk Last Sanitized ISD last erased	Show a read-only information on when the printer memory or storage drive was last erased. Note: Hard Disk Last Sanitized and ISD last erased appear only when a storage drive is installed.
Out of Service Erase Sanitize all information on nonvolatile memory Erase all printer and network settings Erase all apps and app settings Erase all shortcuts and shortcut settings Sanitize all information on hard disk Erase downloads (Erase all macros, fonts, PFOs, etc.) Erase buffered jobs Erase Held jobs Erase Intelligent Storage Drive	Clear all information on nonvolatile memory and on the storage drive. Note: Sanitize all information on hard disk and Erase Intelligent Storage Drive appear only when a storage drive is installed.

Home Screen Customization

Note: This menu appears only in the Embedded Web Server.



Menu	Description
Copy E-mail Fax Held Faxes Release Held Faxes Status/Supplies Job Queue Settings Change Language Address Book Bookmarks Held Jobs USB Drive FTP Scan Profiles Lock Device Scan Center Card Copy Shortcut Center	Specify which icons to show on the home screen.

Update firmware

Menu item	Description
Current Version	Show the current firmware version installed on the printer.
Check for updates now	Check for firmware updates.
Auto check for updates On Off*	Set the printer to check for firmware updates automatically.

About this Printer

Menu item	Description
Asset Tag	Specify the identity of the printer. The maximum length is 32 characters.
Printer's Location	Specify the printer location. The maximum length is 63 characters.
Contact	Specify the contact information for the printer. The maximum length is 63 characters.
Firmware Version	Show the firmware version installed on the printer.
Engine	Show the engine number of the printer.
Serial Number	Show the serial number of the printer.
Export Configuration File to USB	Export the configuration file to a flash drive.

Menu item	Description
Export Compressed Logs to USB	Export the compressed log files to a flash drive.
Send Logs	Send printer log information to Lexmark.

Print

Layout

Menu item	Description
Sides 1-Sided* 2-Sided	Specify whether to print on one side or both sides of the paper.
Flip Style Long Edge* Short Edge	Determine which side of the paper is bound when performing two-sided printing.
Blank Pages Print Do Not Print*	Print blank pages that are included in a print job.
Collate Off (1,1,1,2,2,2) On (1,2,1,2,1,2)*	Keep the pages of a print job stacked in sequence, particularly when printing multiple copies of the job.
Separator Sheets None* Between Copies Between Jobs Between Pages	Insert blank separator sheets when printing.
Separator Sheet Source Tray [x] (1*) Multipurpose Feeder	Specify the paper source for the separator sheet.
Pages per Side Off* 2 pages per side 3 pages per side 4 pages per side 6 pages per side 9 pages per side 12 pages per side 16 pages per side	Print multiple page images on one side of a sheet of paper.

Note: An asterisk (*) next to a value indicates the factory default setting.

Menu item	Description
Pages per Side Ordering Horizontal* Reverse Horizontal Vertical Reverse Vertical	Specify the positioning of multiple page images when using the Pages per Side menu.
Pages per Side Orientation Auto* Landscape Portrait	Specify the orientation of multiple page images when using the Pages per Side menu.
Pages per Side Border None* Solid	Print a border around each page image when using the Pages per Side menu.
Copies 1–9999 (1*)	Specify the number of copies for each print job.
Print Area Normal* Fit to page Whole Page	Set the printable area on a sheet of paper.
Note: An asterisk (*) next to a value indicates the factory default setting.	

Setup

Menu item	Description
Printer Language PCL Emulation PS Emulation*	Set the printer language. Note: Setting a printer language default does not prevent a software program from sending print jobs that use another printer language.
Job Waiting Off* On	Preserve print jobs requiring supplies so that jobs not requiring the missing supplies can print. Note: This menu item appears only when a hard disk or an intelligent storage drive (ISD) is installed.
Job Hold Timeout 0–255 (30*)	Set the time in seconds that the printer waits for user intervention before it holds jobs that require unavailable resources. Note: This menu item appears only when a hard disk or an ISD is installed.
Printer Usage Max Speed Max Yield*	Determine how the color imaging kit operates during printing. Notes: <ul style="list-style-type: none"> • When set to Max Yield, the color imaging kit slows or stops while printing groups of black-only pages. • When set to Max Speed, the color imaging kit always runs while printing, whether color or black pages are being printed.
Note: An asterisk (*) next to a value indicates the factory default setting.	

Menu item	Description
Low-Speed Printer Usage Max Speed Max Yield*	Determine how the color imaging kit operates during low-speed printing. Notes: <ul style="list-style-type: none"> • When set to Max Yield, the color imaging kit slows or stops while printing groups of black-only pages. • When set to Max Speed, the color imaging kit always runs while printing, whether color or black pages are being printed. • This setting only changes printer behavior when the print engine is running at a 25 pages per minute process speed. It has no effect when the print engine is running at faster process speeds.
Download Target RAM* Flash Disk	Specify where to save all permanent resources that have been downloaded to the printer. Note: Flash and Disk appear only when a hard disk or an ISD is installed.
Resource Save Off* On	Determine what the printer does with downloaded resources when it receives a job that requires more than the available memory. Notes: <ul style="list-style-type: none"> • When set to Off, the printer retains downloaded resources only until memory is needed. Resources associated with the inactive printer language are deleted. • When set to On, the printer preserves all the permanent downloaded resources across all language switches. When necessary, the printer shows memory full messages instead of deleting permanent resources.
Print All Order Alphabetical* Newest First Oldest First	Specify the order when you choose to print all held and confidential jobs. Note: This menu item appears only when a hard disk or an ISD is installed.
Note: An asterisk (*) next to a value indicates the factory default setting.	

Quality

Menu item	Description
Print Mode Black and White Color*	Set how the printer generates color content.
Print Resolution 4800 CQ* 1200 dpi	Set the resolution for the printed output. Note: 4800 CQ provides high-quality output at maximum speed.
Toner Darkness 1 to 5 (4*)	Determine the lightness or darkness of text images.
Note: An asterisk (*) next to a value indicates the factory default setting.	

Menu item	Description
Halftone Normal* Detail	Enhance the printed output to have smoother lines with sharper edges.
Color Saver Off* On	Reduce the amount of toner used to print graphics and images. Note: When set to On, this setting overrides the value of the Toner Darkness setting.
RGB Brightness -6 to 6 (0*)	Adjust the brightness of every RGB and gray object on the page. Note: This setting does not affect files where CMYK color specifications are used.
RGB Contrast 0 to 5 (0*)	Adjust the contrast of every RGB and gray object on a page. Note: This setting does not affect files where CMYK color specifications are used.
RGB Saturation 0 to 5 (0*)	Preserve the black and white values while adjusting the color values of every object on the page. Note: This setting does not affect files where CMYK color specifications are used.
Note: An asterisk (*) next to a value indicates the factory default setting.	

Advanced Imaging

Menu item	Description
Color Balance Cyan (0*) Magenta (0*) Yellow (0*) Black (0*)	Adjust the amount of toner that is used for each color.
Color Balance Reset Defaults	Reset all color settings to their default values.
Color Correction Off Auto* Manual	Modify the color settings used to print documents. Notes: <ul style="list-style-type: none"> • Off sets the printer to receive the color correction from the software. • Auto sets the printer to apply different color profiles to each object on the printed page. • Manual allows the customization of the RGB or CMYK color conversions applied to each object on the printed page.
Color Samples Print Color Samples	Print sample pages for each of the RGB and CMYK color conversion tables used in the printer.
Color Adjust	Calibrate the printer to adjust color variations in the printed output.
Spot Color Replacement Set Custom CMYK	Assign specific CMYK values to twenty named spot colors.
Note: An asterisk (*) next to a value indicates the factory default setting.	

Job Accounting

Menu item	Description
Job Accounting Off* On	Set the printer to create a log of the print jobs that it receives. Note: This menu item appears only when a hard disk or an intelligent storage drive (ISD) is installed.
Accounting Log Frequency Daily Weekly Monthly*	Specify how often the printer creates a log file.
Log Action at End of Frequency None* E-mail Current Log E-mail & Delete Current Log Post Current Log Post & Delete Current Log	Specify how the printer responds when the frequency threshold expires. Note: The value defined in Accounting Log Frequency determines when this action is triggered.
Log Near Full Level Off On (5)*	Specify the maximum size of the log file before the printer executes the Log Action at Near Full. Note: This menu item appears only when a hard disk or an ISD is installed.
Log Action at Near Full None* E-mail Current Log E-mail & Delete Current Log E-mail & Delete Oldest Log Post Current Log Post & Delete Current Log Post & Delete Oldest Log Delete Current Log Delete Oldest Log Delete All But Current Delete All Logs	Specify how the printer responds when the hard disk or ISD is nearly full. Note: The value defined in Log Near Full Level determines when this action is triggered.
Log Action at Full None* E-mail & Delete Current Log E-mail & Delete Oldest Log Post & Delete Current Log Post & Delete Oldest Log Delete Current Log Delete Oldest Log Delete All But Current Delete All Logs	Specify how the printer responds when hard disk or ISD usage reaches the maximum limit (100MB).
URL to Post Log	Specify where the printer posts job accounting logs.
E-mail Address to Send Logs	Specify the e-mail address to which the printer sends job accounting logs.
Note: An asterisk (*) next to a value indicates the factory default setting.	

Menu item	Description
Log File Prefix	Specify the prefix for the log files. Note: The current host name defined in the TCP/IP menu is used as the default log file prefix.
Note: An asterisk (*) next to a value indicates the factory default setting.	

PDF

Menu item	Description
Scale To Fit Off* On	Scale the page content to fit the selected paper size.
Annotations Print Do Not Print*	Specify whether to print annotations in the PDF.
Print PDF Error Off On*	Enable the printing of PDF error.
Note: An asterisk (*) next to a value indicates the factory default setting.	

PostScript

Menu item	Description
Print PS Error Off* On	Print a page that describes the PostScript® error. Note: When an error occurs, processing of the job stops, the printer prints an error message, and the rest of the print job is flushed.
Minimum Line Width 1–30 (2*)	Set the minimum stroke width. Note: Jobs printed in 1200 dpi use the value directly.
Lock PS Startup Mode Off On*	Disable the SysStart file. Note: Enabling the SysStart file exposes your printer or network to a security risk.
Image Smoothing Off* On	Enhance the contrast and sharpness of low-resolution images. Note: This setting has no effect on images with a resolution of 300 dpi or higher.
Note: An asterisk (*) next to a value indicates the factory default setting.	

Menu item	Description
Font Priority Resident* Flash/Disk	Establish the font search order. Notes: <ul style="list-style-type: none"> Resident sets the printer to search its memory for the requested font before searching the hard disk or intelligent storage drive (ISD). Flash/Disk sets the printer to search the hard disk or ISD for the requested font before searching the printer memory. This menu item appears only when a hard disk or an ISD is installed.
Wait Timeout Off On* (40 seconds)	Enable the printer to wait for more data before canceling a print job.
Note: An asterisk (*) next to a value indicates the factory default setting.	

PCL

Menu item	Description
Font Source Resident* Disk Download Flash Font Card All	Select the source which contains the default font selection. Notes: <ul style="list-style-type: none"> Disk and Flash appear only when a hard disk or an intelligent storage drive (ISD) that contains fonts is installed. Download appears only if downloaded fonts exist in the printer memory. Font Card appears only when an ISD is installed.
Font Name [List of available fonts] (Courier*)	Select a font from the specified font source.
Symbol Set [List of available symbol set] (10U PC-8*)	Specify the symbol set for each font name. Note: A symbol set is a set of alphabetic and numeric characters, punctuation, and special symbols. Symbol sets support the different languages or specific programs such as math symbols for scientific text.
Pitch 0.08–100.00 (10.00*)	Specify the pitch for fixed or monospaced fonts. Note: Pitch refers to the number of fixed-space characters in a horizontal inch of type.
Orientation Portrait* Landscape Reverse Portrait Reverse Landscape	Specify the orientation of text and graphics on the page.
Note: An asterisk (*) next to a value indicates the factory default setting.	

Menu item	Description
Lines per Page 1–255	Specify the number of lines of text for each page printed through the PCL® data stream. Notes: <ul style="list-style-type: none"> This menu item activates vertical escapement that causes the selected number of requested lines to print between the default margins of the page. 60 is the U.S. factory default setting. 64 is the international factory default setting.
PCL5 Minimum Line Width 1–30 (2*)	Set the initial minimum stroke width.
PCLXL Minimum Line Width 1–30 (2*)	
A4 Width 198 mm* 203 mm	Set the width of the logical page on A4-size paper. Note: Logical page is the space on the physical page where data is printed.
Auto CR after LF On Off*	Set the printer to perform a carriage return after a line feed control command. Note: Carriage return is a mechanism that commands the printer to move the position of the cursor to the first position on the same line.
Auto LF after CR On Off*	Set the printer to perform a line feed after a carriage return control command.
Tray Renumber Assign MP Feeder Assign Tray [x] Assign Manual Paper Assign Manual Envelope	Configure the printer to work with a different print driver or custom application that uses a different set of source assignments to request a given paper source. Choose from the following options: Off*—The printer uses the factory default paper source assignments. None—The paper source ignores the Select Paper Feed command. 0–199—Select a numeric value to assign a custom value to a paper source.
Tray Renumber View Factory Defaults	Show the factory default value assigned for each paper source.
Tray Renumber Restore Defaults	Restore the tray renumber values to their factory defaults.
Print Timeout Off On* (90 seconds)	Set the printer to end a print job after it has been idle for the specified amount of time. Note: Print Timeout Time appears only when Print Timeout is enabled.
Note: An asterisk (*) next to a value indicates the factory default setting.	

Image

Menu item	Description
Auto Fit On Off*	Select the best available paper size and orientation setting for an image. Note: When set to On, this menu item overrides the scaling and orientation settings for the image.
Invert Off* On	Invert bitonal monochrome images. Note: This menu item does not apply to GIF or JPEG image formats.
Scaling Anchor Top Left Best Fit* Anchor Center Fit Height/Width Fit Height Fit Width	Adjust the image to fit the printable area. Note: When Auto Fit is set to On, Scaling is automatically set to Best Fit.
Orientation Portrait* Landscape Reverse Portrait Reverse Landscape	Specify the orientation of text and graphics on the page.
Note: An asterisk (*) next to a value indicates the factory default setting.	

Paper

Tray Configuration

Menu item	Description
Default Source Tray [x] (1*) Multipurpose Feeder Manual Paper Manual Envelope	Set the paper source for all print jobs.
Paper Size/Type Tray [x] Multipurpose Feeder Manual Paper Manual Envelope	Specify the paper size or paper type loaded in each paper source.
Note: An asterisk (*) next to a value indicates the factory default setting.	

Menu item	Description
Substitute Size Off Letter/A4 All Listed*	Set the printer to substitute a specified paper size if the requested size is not loaded in any paper source. Notes: <ul style="list-style-type: none"> • Off prompts the user to load the required paper size. • All Listed allows all available substitutions.
Configure MP Cassette* Manual First	Determine the behavior of the multipurpose feeder. Notes: <ul style="list-style-type: none"> • Cassette configures the multipurpose feeder as the automatic paper source. • Manual sets the multipurpose feeder only for manual-feed print jobs. • First configures the multipurpose feeder as the primary paper source.
Note: An asterisk (*) next to a value indicates the factory default setting.	

Media Configuration

Universal Setup

Menu item	Description
Units of Measure Inches Millimeters	Specify the unit of measurement for the universal paper. Note: Inches is the U.S. factory default setting. Millimeters is the international factory default setting.
Portrait Width 3.00–52.00 inches (8.5*) 76–1321 mm (216*)	Set the portrait width of the universal paper.
Portrait Height 3.00–52.00 inches (14*) 76–1321 mm (356*)	Set the portrait height of the universal paper.
Feed Direction Short Edge* Long Edge	Set the printer to pick paper from the short edge or long edge direction. Note: Long Edge appears only when the longest edge is shorter than the maximum width supported.
Multiple Universal Sizes Tray [x] Multipurpose Feeder	Assign a unique dimension for multiple universal sizes that are loaded in each paper source. Note: This setting appears only when enabled in the Device menu. From the home screen, touch Settings > Device > Maintenance > Configuration Menu > Tray Configuration > Multiple Universal Sizes .
Note: An asterisk (*) next to a value indicates the factory default setting.	

Custom Scan Sizes

Menu item	Description
Custom Scan Size [x] Scan Size Name Width 1–8.5 inches (8.5*) 25–216 mm (216*) Height 1–25 inches (11*) 25–635 mm (279*) Orientation Portrait* Landscape 2 scans per side Off* On	Assign a scan size name and configure the scan settings.

Media Types

Menu item	Description
Plain Paper Card Stock Recycled Glossy Labels Vinyl Labels Bond Envelope Letterhead Preprinted Colored Paper Light Paper Heavy Paper Rough/Cotton Custom Type [X]	Specify the texture, weight, and orientation of the paper.

Copy

Copy Defaults

Menu item	Description
Content Type Text Text/Photo* Photo Graphics	Improve the output result based on the content of the original document.
Content Source Black and White Laser Color Laser* Inkjet Photo/Film Magazine Newspaper Press Other	Improve the output result based on the source of the original document.
Sides 1 sided to 1 sided* 1 sided to 2 sided 2 sided to 1 sided 2 sided to 2 sided	Specify the scanning behavior based on the original document.
Separator Sheets None* Between Copies Between Jobs Between Pages	Specify whether to insert blank separator sheets when printing.
Separator Sheet Source Tray [x] (1*) Multipurpose Feeder	Specify the paper source for the separator sheet.
Color Off On* Auto	Set the printer to generate color output from a scan job.
Pages per Side Off* 2 Portrait pages 4 Portrait pages 2 Landscape pages 4 Landscape pages	Specify the number of page images to print on one side of a sheet of paper.
Note: An asterisk (*) next to a value indicates the factory default setting.	

Menu item	Description
Print Page Borders Off* On	Place a border around each image when printing multiple pages on a single page.
Collate Off [1,1,1,2,2,2] On [1,2,1,2,1,2]*	Print multiple copies in sequence.
“Copy from” Size [List of paper sizes]	Set the paper size of the original document. Note: Letter is the U.S. factory default setting. A4 is the international factory default setting.
“Copy to” Source Tray [x] (1*) Multipurpose Feeder Auto Size Match	Specify the paper source for the copy job.
Temperature -4 to 4 (0*)	Specify whether to generate a cooler or warmer output.
Darkness 1 to 9 (5*)	Adjust the darkness of the scanned image.
Number of Copies 1–9999 (1*)	Specify the number of copies.
Header/Footer Left Header Middle Header Right Header Left Footer Middle Footer Right Footer	Specify the header or footer information on the scanned image.
Overlay Confidential Copy Draft Urgent Custom Off*	Specify the overlay text to print on each copy.
Custom overlay	Type the text for the Custom choice in the Overlay menu.
Note: An asterisk (*) next to a value indicates the factory default setting.	

Advanced Imaging

Menu item	Description
Color Balance Cyan (0*) Magenta (0*) Yellow (0*)	Adjust the color intensity for cyan, magenta, and yellow.
Color Dropout Color Dropout (None*) Default Red Threshold (128*) Default Green Threshold (128*) Default Blue Threshold(128*)	Specify which color to drop during scanning, and adjust the dropout setting for that color.
Auto Color Detect Color Sensitivity (5*) Area Sensitivity (5*)	Configure the auto color detection setting.
Contrast Best for content* 0–5	Specify the contrast for the scanned image.
Background Removal Background Detection (Content-based*) Level (0*)	Remove the background color or image noise from the original document. Notes: <ul style="list-style-type: none"> • Content-based removes the background color from the original document . • Fixed removes image noise from a photo.
Auto Center Off* On	Align the content at the center of the page.
Mirror Image Off* On	Create a mirror image of the original document.
Negative Image Off* On	Create a negative image of the original document.
Shadow Detail -4 to 4 (0*)	Adjust the shadow detail in the original document.
Scan Edge to Edge Off* On	Scan the original document from edge to edge.
Sharpness 1–5 (3*)	Adjust the sharpness of the scanned image.
Note: An asterisk (*) next to a value indicates the factory default setting.	

Admin Controls

Menu item	Description
Allow Color Copies Off On*	Print copies in color.
Allow Priority Copies Off On*	Interrupt a print job to make copies.
Custom Job Scanning Off* On	Set the printer to scan the first set of original documents using the specified settings, and then scan the next set with the same or different settings. Note: This menu item appears only when a hard disk or an intelligent storage drive (ISD) is installed.
Allow Save as Shortcut Off On*	Save copy settings as a shortcut.
Adjust ADF Skew Off On*	Set the printer to adjust the skewed images from documents that are scanned from the ADF.
Sample copy Off* On	Print a sample copy to check the quality before printing the remaining copies. Note: This menu item appears only when a hard disk or an ISD is installed.
Note: An asterisk (*) next to a value indicates the factory default setting.	

Fax

Fax Defaults

Fax Mode

Menu item	Description
Fax Mode Fax Fax Server Disabled	Select a fax mode. Note: Depending on your printer model, the factory default setting may vary.

Fax Setup

General Fax settings

Menu item	Description
Fax Name	Specify your fax ID.
Fax Number	Specify your fax number.
Fax ID Fax Name Fax Number*	Set the fax ID to use during fax negotiation.
Enable Manual Fax Off* On	Turn on the manual fax function in the printer. Notes: <ul style="list-style-type: none"> • This menu item requires a line splitter and a telephone handset. • Use a regular telephone line to answer an incoming fax job and to dial a fax number. • To go directly to the manual fax function, touch # and 0 on the keypad.
Memory Use All receive Mostly receive Equal* Mostly send All send	Set the amount of internal printer memory allocated for faxing. Note: This menu item prevents memory buffer conditions and failed faxes.
Cancel Faxes Allow* Don't Allow	Cancel outgoing or incoming faxes.
Fax Number Masking Off* From Left From Right	Specify the format for masking an outgoing fax number.
Digits to Mask 0–58 (0*)	Specify the number of digits to mask in an outgoing fax number.
Enable Line Connected Detection Off On*	Determine whether a telephone line is connected to the printer. Note: Events are detected immediately.
Enable Line In Wrong Jack Detection Off On*	Determine whether a telephone line is connected to the correct port on the printer. Note: Events are detected immediately.
Note: An asterisk (*) next to a value indicates the factory default setting.	

Menu item	Description
Enable Extension in Use Support Off On*	Determine whether a telephone line is used by another device, such as another phone on the same line. Note: Events are detected immediately.
Optimize Fax Compatibility	Configure the printer fax functionality for optimal compatibility with other fax machines.
Fax Transport T.38 Analog G.711 etherFAX	Set the fax transport method. Note: This menu item appears only if an etherFAX or Fax over IP (FoIP) license bundle is installed in the printer.
Note: An asterisk (*) next to a value indicates the factory default setting.	

HTTPS Fax Settings

Note: This menu appears only if Fax Transport is set to etherFAX.

Menu item	Description
HTTPS service URL	Specify the etherFAX service URL.
HTTPS Proxy	Specify a proxy server URL.
HTTPS Proxy User	Specify the user name and password for the proxy server.
HTTPS Proxy Password	
Fax Send Encryption Disabled Enabled* Required	Enable encryption for outgoing fax messages.
Fax Receive Encryption Disabled Enabled* Required	Enable encryption for incoming fax messages.
HTTPS Fax Status	Show the etherFAX communication status.
Note: An asterisk (*) next to a value indicates the factory default setting.	

Fax Send Settings

Menu item	Description
Resolution Standard* Fine Super Fine Ultra Fine	Set the resolution of the scanned image. Note: A higher resolution increases fax transmission time and requires more memory.
Note: An asterisk (*) next to a value indicates the factory default setting.	

Menu item	Description
Original Size [List of paper sizes] (Mixed Sizes*)	Specify the size of the original document.
Orientation Portrait* Landscape	Specify the orientation of the original document.
Sides Off* Short Edge Long Edge	Specify the orientation of the original document when scanning on both sides of the document.
Content Type Text* Text/Photo Photo Graphics	Improve the output result based on the content of the original document.
Content Source Black and White Laser Color Laser* Inkjet Photo/Film Magazine Newspaper Press Other	Improve the output result based on the source of the original document.
Darkness 1–9 (5*)	Adjust the darkness of the scanned image.
Behind a PABX On Off*	Set the printer to dial a fax number without waiting to recognize the dial tone. Note: Private Automated Branch Exchange (PABX) is a telephone network that allows a single access number to offer multiple lines to outside callers.
Dial Mode Tone* Pulse	Specify the dial mode for incoming or outgoing faxes.
Note: An asterisk (*) next to a value indicates the factory default setting.	

Advanced Imaging

Menu item	Description
Color Balance Cyan - Red -4 to 4 (0*) Magenta - Green -4 to 4 (0*) Yellow - Blue -4 to 4 (0*)	Adjust the color intensity during scanning.
Color Dropout Color Dropout (None*) Default Red Threshold (128*) Default Green Threshold (128*) Default Blue Threshold (128*)	Specify which color to drop during scanning, and adjust the dropout setting for that color.
Contrast Best for Content* 0 1 2 3 4 5	Set the contrast of the output.
Background Removal Level -4 to 4 (0*)	Adjust the amount of background visible on a scanned image.
Mirror Image Off* On	Create a mirror image of the original document.
Negative Image Off* On	Create a negative image of the original document.
Shadow Detail -4 to 4 (0*)	Adjust the amount of shadow detail visible on a scanned image.
Scan Edge to Edge On Off*	Allow edge-to-edge scanning of the original document.
Sharpness 1–5 (3*)	Adjust the sharpness of the scanned image.
Temperature -4 to 4 (0*)	Specify whether to generate a cooler or warmer output.
Note: An asterisk (*) next to a value indicates the factory default setting.	

Admin Controls

Menu item	Description
Automatic Redial 0–9 (5*)	Specify the number of attempts that the printer redials before it cancels sending the fax to a specified destination.
Redial Frequency 1–200 minutes (3*)	Increase the time between redial attempts to increase the chance of sending fax successfully.
Enable ECM On* Off	Activate Error Correction Mode (ECM) for fax jobs. Note: ECM detects and corrects errors in the fax transmission process caused by telephone line noise and poor signal strength.
Enable Fax Scans On* Off	Create faxes using the printer scanner.
Driver to Fax On* Off	Allow the print driver to send fax.
Allow Save as Shortcut On* Off	Save fax numbers as shortcuts on the printer.
Max Speed 33600* 14400 9600 4800 2400	Set the maximum speed for sending fax.
Custom Job Scanning Off* On	Turn on scanning of custom jobs by default. Note: This menu item appears only when a hard disk or an intelligent storage drive (ISD) is installed.
Scan Preview Off* On	Show a preview of the scan on the display. Note: This menu item appears only when a hard disk or an ISD is installed.
Adjust ADF Skew Off On*	Correct slight skew in the scanned image.
Enable Color Fax Scans Off by Default* On by Default Never Use Always Use	Enable color scans for fax.
Note: An asterisk (*) next to a value indicates the factory default setting.	

Menu item	Description
Auto Convert Color Faxes to Mono Faxes On* Off	Convert all outgoing color faxes to black and white.
Confirm Fax Number Off* On	Ask the user to confirm the fax number.
Dial Prefix	Set a dialing prefix.
Dialing Prefix Rules	Establish a dialing prefix rule.
Note: An asterisk (*) next to a value indicates the factory default setting.	

Fax Receive Settings

Menu item	Description
Fax Job Waiting None* Toner Toner and Supplies	Remove fax jobs that request specific unavailable resources from the print queue.
Rings to Answer 1–25 (3*)	Set the number of rings required before the printer answers the incoming calls.
Auto Reduction On* Off	Scale incoming fax to fit on the page.
Paper Source Tray [X] Auto*	Set the paper source for printing incoming fax.
Sides On Off*	Print on both sides of the paper.
Separator Sheets None* Before Job After Job	Specify whether to insert blank separator sheets when printing.
Separator Sheet Source Tray [X] (1*)	Specify the paper source for the separator sheet.
Output Bin Standard Bin	Specify the output bin for received faxes.
Fax Footer On Off*	Print the transmission information at the bottom of each page from a received fax.
Note: An asterisk (*) next to a value indicates the factory default setting.	

Menu item	Description
Fax Footer Time Stamp Receive* Print	Print the time stamp at the bottom of each page from a received fax.
Holding Faxes Held Fax Mode Off* Always On Manual Scheduled	Hold received faxes from printing until they are released.
Holding Faxes Fax Holding Schedule	Assign a schedule for holding faxes. Note: This menu item appears only if Held Fax Mode is set to Scheduled.
Note: An asterisk (*) next to a value indicates the factory default setting.	

Admin Controls

Menu item	Description
Enable Fax Receive On* Off	Set the printer to receive fax.
Enable Color Fax Receive On* Off	Set the printer to receive fax in color.
Enable Caller ID On Off*	Show the caller ID information of the incoming call on the printer display.
Block No Name Fax On Off*	Block incoming faxes without fax IDs.
Banned Fax List Add Banned Fax	Specify the phone numbers that you want to block.
Answer On All Rings* Single Ring Only Double Ring Only Triple Ring Only Single or Double Rings Only Single or Triple Rings Only Double or Triple Rings Only	Set a distinctive ring pattern for incoming fax.
Auto Answer On* Off	Set the printer to receive fax automatically.
Note: An asterisk (*) next to a value indicates the factory default setting.	

Menu item	Description
Manual Answer Code 0–9 (9*)	Manually enter a code on the telephone number pad to begin receiving fax. Notes: <ul style="list-style-type: none"> • This menu item appears only when the printer shares a line with a telephone. • This menu item appears only when you set the printer to receive fax manually.
Fax Forwarding Print* Print and Forward Forward	Specify whether to forward received fax.
Forward To Destination 1 Destination 2	Specify where to forward received fax. Note: This menu item appears only when Fax Forwarding is set to Print and Forward or Forward.
Max Speed 33600* 14400 9600 4800 2400	Set the maximum speed for transmitting fax.
Note: An asterisk (*) next to a value indicates the factory default setting.	

Fax Cover Page

Menu item	Description
Fax Cover Page Off by Default* On by Default Never Use Always Use	Configure the settings for the fax cover page.
Include To field Off* On	
Include From field Off* On	
From	
Include Message Field Off* On	
Message:	
Include Logo Off* On	
Include Footer [x] Off* On	
Footer [x]	
Note: An asterisk (*) next to a value indicates the factory default setting.	

Fax Log Settings

Menu item	Description
Transmission Log Frequency Always* Never Only for Error	Specify how often the printer creates a transmission log.
Transmission Log Action Print Off On* E-mail Off* On	
Note: An asterisk (*) next to a value indicates the factory default setting.	

Menu item	Description
Receive Error Log Print Never* Print on Error	Print a log for fax-receive failures.
Auto Print Logs On* Off	Print all fax activity.
Log Paper Source Tray [x] (1*)	Specify the paper source for printing logs.
Logs Display Remote Fax Name* Dialed Number	Identify the sender by remote fax name or fax number.
Enable Job Log On* Off	View a summary of all fax jobs.
Enable Call Log On* Off	View a summary of the fax call history.
Log Output Bin Standard Bin* Bin [x]	Specify the output bin for printed logs.
Note: An asterisk (*) next to a value indicates the factory default setting.	

Speaker Settings

Menu item	Description
Speaker Mode Always Off* Always On On until Connected	Set the fax speaker mode.
Speaker Volume Low* High	Adjust the fax speaker volume.
Ringer Volume Off* On	Enable the ringer volume.
Note: An asterisk (*) next to a value indicates the factory default setting.	

VoIP Settings

Menu item	Description
VoIP Protocol SIP* H.323	Set the Voice over Internet Protocol (VoIP) protocol.
STUN Server	Specify the STUN server to traverse a firewall.
Force Fax Mode Off On*	Switch VoIP gateway from analog to T.38 at the beginning of a fax call.
Force Fax Mode Delay 0–15 (7*)	Set the time delay in seconds when sending another invite of Force Fax Mode.
Note: An asterisk (*) next to a value indicates the factory default setting.	

SIP Settings

Menu item	Description
Proxy	Specify the IP address of the system that converts the phone number to an IP address where the fax is sent.
Registrar	Specify a name or IP address of the system that handles the registration of Session Initiation Protocol (SIP) clients.
User	Specify the name of the user for SIP.
Password	Specify the password that is used in registering with the SIP Registrar.
Auth ID	The user name that is used when registering. Note: If the Auth ID setting is not set, the setting uses the user name of the User field instead.
Transport For Registration UDP* TCP	Set the SIP transport type for registration.
Transport For Incoming Calls UDP* TCP UDP And TCP	Set the SIP transport type for incoming calls.
Transport For Outgoing Calls UDP* TCP	Set the SIP transport type for outgoing calls.
Outbound Proxy	Specify an outbound proxy to forward all SIP communication.
Contact	Specify a contact name for SIP.
Realm	Specify a realm name for SIP. Note: If the Realm setting is not set, the setting uses the name of the Contact instead.
Note: An asterisk (*) next to a value indicates the factory default setting.	

Menu item	Description
SIP Registration Status	Show the status of the SIP Registration.
Note: An asterisk (*) next to a value indicates the factory default setting.	

H.323 Settings

Menu item	Description
Gateway	Specify the H.323 gateway IP address.
Gatekeeper	Specify the H.323 gatekeeper.
User	Specify the user name used with the H.323 gateway.
Password	Specify the password for the H.323 gateway.
Enable Fast Start Off* On	Enable Fast Start.
Disable H.245 Tunneling Off* On	Disable H.323 Tunneling.
Disable Gatekeeper Discovery Off On*	Disable H.323 Gatekeeper Discovery.
Note: An asterisk (*) next to a value indicates the factory default setting.	

T.38 Settings

Menu item	Description
Indicator Redundancy 0–5 (3*)	Set the number of times that a fax indicator is repeated in the T.38 communication.
Low Speed Redundancy 0–5 (3*)	Set the number of times that low speed data is repeated in the T.38 communication.
High Speed Redundancy 0–5 (1*)	Set the number of times that high-speed data is repeated in the T.38 communication.
Note: An asterisk (*) next to a value indicates the factory default setting.	

Fax Server Setup

General Fax Settings

Menu item	Description
To Format	Specify a fax recipient. Note: If you want to use the fax number, then type the number sign (#) before a number.
Note: An asterisk (*) next to a value indicates the factory default setting.	

Menu item	Description
Reply Address	Specify a reply address for sending fax.
Subject	Specify the fax subject and message.
Message	
Enable analog receive Off* On	Set the printer to receive analog faxes.
Note: An asterisk (*) next to a value indicates the factory default setting.	

Fax Server E-mail Settings

Menu item	Description
Use E-mail SMTP Server On Off*	Use the Simple Mail Transfer Protocol (SMTP) settings for e-mail in receiving and sending faxes. Note: When set to On, all other settings of the Fax Server E-mail Settings menu are not shown.
Primary SMTP Gateway	Type the IP address or host name of the primary SMTP server.
Primary SMTP Gateway Port 1–65535 (25*)	Enter the port number of the primary SMTP server.
Secondary SMTP Gateway	Type the server IP address or host name of your secondary or backup SMTP server.
Secondary SMTP Gateway Port 1–65535 (25*)	Enter the server port number of your secondary or backup SMTP server.
SMTP Timeout 5–30 (30*)	Set the time before the printer times out if the SMTP server does not respond.
Reply Address	Specify a reply address for sending fax.
Use SSL/TLS Disabled* Negotiate Required	Specify whether to send fax using an encrypted link.
Require Trusted Certificate Off On*	Specify a trusted certificate when accessing the SMTP server.
SMTP Server Authentication No authentication required* Login / Plain NTLM CRAM-MD5 Digest-MD5 Kerberos 5	Set the authentication type for the SMTP server.
Note: An asterisk (*) next to a value indicates the factory default setting.	

Menu item	Description
Device-Initiated E-mail None* Use Device SMTP Credentials	Specify whether credentials are required for device-initiated e-mail.
User-Initiated E-mail None* Use Device SMTP Credentials Use Session User ID and Password Use Session E-mail address and Password Prompt user	Specify whether credentials are required for user-initiated e-mail.
Use Active Directory Device Credentials Off* On	Enable user credentials and group destinations to connect to the SMTP server.
Device Userid	Specify the user ID and password to connect to the SMTP server.
Device Password	
Kerberos 5 REALM	Specify the realm for the Kerberos 5 authentication protocol.
NTLM Domain	Specify the domain name for the NTLM security protocol.
Disable "SMTP server not set up" error Off* On	Hide the "SMTP server not set up" error message.
Note: An asterisk (*) next to a value indicates the factory default setting.	

Fax Server Scan Settings

Menu item	Description
Image Format TIFF (.tif) PDF (.pdf)* XPS (.xps) TXT (.txt) RTF (.rtf) DOCX (.docx) XLSX (.xlsx) CSV (.csv)	Specify the file format for the scanned image.
Content Type Text* Text/Photo Photo Graphics	Improve the output result based on the content of the original document.
Note: An asterisk (*) next to a value indicates the factory default setting.	

Menu item	Description
Content Source Black and White Laser Color Laser* Inkjet Photo/Film Magazine Newspaper Press Other	Improve the output result based on the source of the original document.
Fax Resolution Standard* Fine Super Fine Ultra Fine	Set the fax resolution.
Sides Off* Short Edge Long Edge	Specify the orientation of the original document when scanning on both sides of the document.
Darkness 1–9 (5*)	Set the darkness of the output.
Orientation Portrait* Landscape	Specify the orientation of text and graphics on the page.
Original Size [List of paper sizes]	Set the paper size of the original document. Notes: <ul style="list-style-type: none"> • Mixed Sizes is the U.S. factory default setting. A4 is the international factory default setting. • This setting may vary depending on your printer model.
Use Multi-Page TIFF Off On*	Choose between single- and multiple-page TIFF files.
Note: An asterisk (*) next to a value indicates the factory default setting.	

E-mail

E-mail Setup

Menu item	Description
Primary SMTP Gateway	Type the IP address or host name of the primary SMTP server for sending e-mail.
Primary SMTP Gateway Port 1–65535 (25*)	Enter the port number of the primary SMTP server.
Secondary SMTP Gateway	Type the server IP address or host name of your secondary or backup SMTP server.
Secondary SMTP Gateway Port 1–65535 (25*)	Enter the server port number of your secondary or backup SMTP server.
SMTP Timeout 5–30 seconds (30*)	Set the time before the printer times out if the SMTP server does not respond.
Reply Address	Specify a reply address in the e-mail.
Always use SMTP default Reply Address On Off*	Always use the default reply address in the SMTP server.
Use SSL/TLS Disabled* Negotiate Required	Specify whether to send e-mail using an encrypted link.
Require Trusted Certificate Off On*	Require a trusted certificate when accessing the SMTP server.
SMTP Server Authentication No authentication required* Login / Plain NTLM CRAM-MD5 Digest-MD5 Kerberos 5	Set the authentication type for the SMTP server.
Device-Initiated E-mail None* Use Device SMTP Credentials	Specify whether credentials are required for device-initiated e-mail.
Note: An asterisk (*) next to a value indicates the factory default setting.	

Menu item	Description
User-Initiated E-mail None* Use Device SMTP Credentials Use Session User ID and Password Use Session E-mail address and Password Prompt user	Specify whether credentials are required for user-initiated e-mail.
Use Active Directory Device Credentials Off* On	Specify whether credentials are required for user-initiated e-mail.
Device Userid	Specify the user ID and password to connect to the SMTP server.
Device Password	
Kerberos 5 REALM	Specify the realm for the Kerberos 5 authentication protocol.
NTLM Domain	Specify the domain name for the NTLM security protocol.
Disable “SMTP server not set up” error Off* On	Hide the “SMTP server not set up” error message.
Note: An asterisk (*) next to a value indicates the factory default setting.	

E-mail Defaults

Menu item	Description
Subject:	Specify the e-mail subject and message.
Message:	
File Name	Specify the filename for the scanned document.
Format JPEG (.jpg) PDF (.pdf)* TIFF (.tif) XPS (.xps) TXT (.txt) RTF (.rtf) DOCX (.docx) XLSX (.xlsx) CSV (.csv)	Specify the file format of the scanned document.
Global OCR Settings Recognized Languages Auto Rotate (Off*) Despeckle (Off*) Auto Contrast Enhance (Off*)	Configure the settings for optical character recognition (OCR). Note: This menu item appears only if you have purchased and installed an OCR solution.
Note: An asterisk (*) next to a value indicates the factory default setting.	

Menu item	Description
PDF Settings PDF Version (1.5*) Archival Version (A-1a*) Highly Compressed (Off*) Secure (Off*) Searchable (Off*) Archival (PDF/A) (Off*)	Configure the PDF settings of the scanned document. Notes: <ul style="list-style-type: none"> • Archival Version and Archival (PDF/A) are supported only when PDF Version is set to 1.4. • Highly Compressed appears only when a hard disk or an intelligent storage drive (ISD) is installed.
Content Type Text Text/Photo* Photo Graphics	Improve the output result based on the content type of the original document.
Content Source Black and White Laser Color Laser* Inkjet Photo/Film Magazine Newspaper Press Other	Improve the output result based on the content source of the original document.
Color Black and White Gray Color* Auto	Set the printer to capture file content in color or in mono.
Resolution 75 dpi 150 dpi* 200 dpi 300 dpi 400 dpi 600 dpi	Set the resolution of the scanned image.
Darkness 1–9 (5*)	Adjust the darkness of the scanned image.
Orientation Portrait* Landscape	Specify the orientation of the original document.
Original Size Mixed Sizes*	Set the paper size of the original document.
Note: An asterisk (*) next to a value indicates the factory default setting.	

Menu item	Description
Sides Off* Short Edge Long Edge	Specify the orientation of the original document when scanning on both sides of the document.
Note: An asterisk (*) next to a value indicates the factory default setting.	

Advanced Imaging

Menu item	Description
Color Balance Cyan (0*) Magenta (0*) Yellow (0*)	Adjust the color intensity for cyan, magenta, and yellow.
Color Dropout Color Dropout (None*) Default Red Threshold (128*) Default Green Threshold (128*) Default Blue Threshold (128*)	Specify which color to drop during scanning, and adjust the dropout setting for that color.
Auto Color Detect Color Sensitivity (5*) Area Sensitivity (5*) E-mail Bit Depth (1 bit*) Minimum Scan Resolution (300 dpi*)	Configure the auto color detection setting.
JPEG Quality Best for content* 5–95	Set the JPEG quality of the scanned image.
Contrast Best for content* 0–5	Specify the contrast for the scanned image.
Background Removal Background Detection (Content-based*) Level (0*)	Remove the background color or image noise from the original document. Notes: <ul style="list-style-type: none"> • Content-based removes the background color from the original document. • Fixed removes image noise from a photo.
Mirror Image Off* On	Create a mirror image of the original document.
Negative Image Off* On	Create a negative image of the original document.
Note: An asterisk (*) next to a value indicates the factory default setting.	

Menu item	Description
Shadow Detail -4 to 4 (0*)	Adjust the shadow detail in the scanned image.
Scan Edge to Edge Off* On	Scan the original document from edge to edge.
Sharpness 1–5 (3*)	Adjust the sharpness in the scanned image.
Temperature -4 to 4 (0*)	Generate a bluer or redder output of the original document.
Blank Pages Blank Page Removal (Do Not Remove*) Blank Page Sensitivity (5*)	Set the sensitivity of scans in relation to blank pages in the original document.
Note: An asterisk (*) next to a value indicates the factory default setting.	

Admin Controls

Menu item	Description
Max E-mail Size 0–65535 (0*)	Set the allowable file size for each e-mail.
Size Error Message	Specify an error message that the printer sends when an e-mail exceeds its allowable file size. Note: You can type up to 1024 characters.
Limit Destinations	Limit sending of e-mail only to the specified list of domain name. Note: Use a comma to separate each domain.
Send Me a Copy Never appears* On by Default Off by Default Always On	Send a copy of the e-mail to yourself.
Allow self e-mails only Off* On	Set the printer to send e-mails to yourself only.
Use cc:/bcc: Off* On	Enable carbon copy and blind carbon copy in e-mail.
Use Multi-Page TIFF Off On*	Enable scanning of multiple TIFF images in one TIFF file.
Note: An asterisk (*) next to a value indicates the factory default setting.	

Menu item	Description
TIFF Compression JPEG LZW*	Specify the compression type for TIFF files.
Text Default 5–95 (75*)	Set the text quality in the content being scanned.
Text/Photo Default 5–95 (75*)	Set the text and photo quality in the content being scanned.
Photo Default 5–95 (50*)	Set the photo quality of the content being scanned.
Adjust ADF Skew Off On*	Set the printer to adjust the skewed images from documents that are scanned from the ADF.
Transmission Log Print log* Do Not Print Log Print Only For Error	Print a transmission log for e-mail scans.
Log Paper Source Tray [x] (1*) Multipurpose Feeder	Specify the paper source for printing e-mail logs.
Custom Job Scanning Off* On	Set the printer to scan the first set of original documents using the specified settings, and then scan the next set with the same or different settings. Note: This menu item appears only when a hard disk or an ISD is installed.
Scan Preview Off* On	Show a scan preview of the original document. Note: This menu item appears only when a hard disk or an ISD is installed.
Allow Save as Shortcut Off On*	Save an e-mail address as a shortcut.
E-mail Images Sent As Attachment* Web Link	Specify how to send the images that are included in the e-mail.
Reset E-mail Information After Sending Off On*	Reset the To, Subject, Message, and Filename fields to their default values after sending an e-mail.
Note: An asterisk (*) next to a value indicates the factory default setting.	

Web Link Setup

Menu item	Description
Server	Specify the credentials of the server that is hosting the images that are included in the e-mail.
Login	
Password	
Path	
File Name	
Web Link	

FTP

FTP Defaults

Menu item	Description
Format JPEG (.jpg) PDF (.pdf)* TIFF (.tif) XPS (.xps) TXT (.txt) RTF (.rtf) DOCX (.docx) XLSX (.xlsx) CSV (.csv)	Specify the file format for the scanned image.
Global OCR Settings Recognized Languages Auto Rotate (Off*) Despeckle (Off*) Auto Contrast Enhance (Off*)	Configure the settings for optical character recognition (OCR). Note: This menu item appears only if you have purchased and installed an OCR solution.
PDF Settings PDF Version (1.5*) Archival Version (A-1a*) Highly Compressed (Off*) Secure (Off*) Searchable (Off*) Archival (PDF/A) (Off*)	Configure the PDF settings for the scanned image. Notes: <ul style="list-style-type: none"> Archival Version and Archival (PDF/A) are supported only when PDF Version is set to 1.4. Highly Compressed appears only when a hard disk or an intelligent storage drive (ISD) is installed.
Note: An asterisk (*) next to a value indicates the factory default setting.	

Menu item	Description
Content Type Text Text/Photo* Graphics Photo	Improve the output result based on the content type of the original document.
Content Source Black and White Laser Color Laser* Inkjet Photo/Film Magazine Newspaper Press Other	Improve the output result based on the content source of the original document.
Color Black and White Gray Color* Auto	Set the printer to capture file content in color or in mono.
Resolution 75 dpi 150 dpi* 200 dpi 300 dpi 400 dpi 600 dpi	Set the resolution of the scanned image.
Darkness 1–9 (5*)	Adjust the darkness of the scanned image.
Orientation Portrait* Landscape	Specify the orientation of the original document.
Original Size Mixed Sizes*	Set the paper size of the original document.
Sides Off* Long Edge Short Edge	Specify the orientation when scanning on both sides of the document.
File Name	Specify the file name of the scanned image.
Note: An asterisk (*) next to a value indicates the factory default setting.	

Advanced Imaging

Menu item	Description
Color Balance Cyan (0*) Magenta (0*) Yellow (0*)	Adjust the color intensity for cyan, magenta, and yellow.
Color Dropout Color Dropout (None*) Default Red Threshold (128*) Default Green Threshold (128*) Default Blue Threshold (128*)	Specify which color to drop during scanning, and adjust the dropout setting for that color.
Auto Color Detect Color Sensitivity (5*) Area Sensitivity (5*) FTP Bit Depth (1 bit*) Minimum Scan Resolution (300 dpi*)	Configure the auto color detection setting.
JPEG Quality Best for content* 5–95	Set the JPEG quality of the scanned image.
Contrast Best for content* 0 1 2 3 4 5	Specify the contrast for the scanned image.
Background Removal Background Detection (Content-based*) Level (0*)	Remove the background color or image noise from the original document. Notes: <ul style="list-style-type: none"> • Content-based removes the background color from the original document . • Fixed removes image noise from a photo.
Mirror Image Off* On	Create a mirror image of the original document.
Negative Image Off* On	Create a negative image of the original document.
Shadow Detail -4 to 4 (0*)	Adjust the shadow detail in the scanned image.
Note: An asterisk (*) next to a value indicates the factory default setting.	

Menu item	Description
Scan Edge to Edge Off* On	Allow edge-to-edge scanning of the original document.
Sharpness 1–5 (3*)	Adjust the sharpness in the scanned image.
Temperature -4 to 4 (0*)	Generate a bluer or redder output of the original document.
Blank Pages Blank Page Removal (Do Not Remove*) Blank Page Sensitivity (5*)	Set the sensitivity of scans in relation to blank pages in the original document.
Note: An asterisk (*) next to a value indicates the factory default setting.	

Admin Controls

Menu item	Description
Text Default 5–95 (75*)	Set the quality of text on the scanned image.
Text/Photo Default 5–95 (75*)	Set the quality of text and photo on the scanned image.
Photo Default 5–95 (50*)	Set the quality of photo on the scanned image.
Use Multi-Page TIFF On* Off	Enable scanning of multiple TIFF images in one TIFF file.
TIFF Compression LZW* JPEG	Specify the compression type for TIFF files.
Transmission Log Print Log* Do Not Print Log Print Only For Error	Print a transmission log for FTP scans.
Log Paper Source Tray [x] (1*) Multipurpose Feeder	Specify the paper source for printing FTP logs.
Custom Job Scanning Off* On	Set the printer to scan the first set of original documents using the specified settings, and then scan the next set with the same or different settings. Note: This menu item appears only when a hard disk or an ISD is installed.
Scan Preview Off* On	Show a preview of the original document. Note: This menu item appears only when a hard disk or an ISD is installed.
Note: An asterisk (*) next to a value indicates the factory default setting.	

Menu item	Description
Allow Save as Shortcut Off On*	Save an FTP address as a shortcut.
Adjust ADF Skew Off* On	Set the printer to adjust the skewed images from documents that are scanned from the ADF.
Use Passive FTP Off* On	Let the FTP server specify the data port that the printer connects to.
Note: An asterisk (*) next to a value indicates the factory default setting.	

USB Drive

Flash Drive Scan

Menu item	Description
Format JPEG (.jpg) PDF (.pdf)* TIFF (.tif) XPS (.xps) TXT (.txt) RTF (.rtf) DOCX (.docx) XLSX (.xlsx) CSV (.csv)	Specify the file format for the scanned image.
Global OCR Settings Recognized Languages Auto Rotate (Off*) Despeckle (Off*) Auto Contrast Enhance (Off*)	Configure the settings for optical character recognition (OCR). Note: This menu item appears only if you have purchased and installed an OCR solution.
PDF Settings PDF Version (1.5*) Archival Version (A-1a*) Highly Compressed (Off*) Secure (Off*) Searchable (Off*) Archival (PDF/A) (Off*)	Configure the PDF settings of the scanned image. Notes: <ul style="list-style-type: none"> Archival Version and Archival (PDF/A) are supported only when PDF Version is set to 1.4. Highly Compressed appears only when a hard disk or an intelligent storage drive (ISD) is installed.
Note: An asterisk (*) next to a value indicates the factory default setting.	

Menu item	Description
Content Type Text Text/Photo* Graphics Photo	Improve the output result based on the content type of the original document.
Content Source Black and White Laser Color Laser* Inkjet Photo/Film Magazine Newspaper Press Other	Improve the output result based on the content source of the original document.
Color Black and White Gray Color* Auto	Set the printer to capture file content in color or in mono.
Resolution 75 dpi 150 dpi* 200 dpi 300 dpi 400 dpi 600 dpi	Set the resolution of the scanned image.
Darkness 1–9 (5*)	Adjust the darkness of the scanned image.
Orientation Portrait* Landscape	Specify the orientation of the original document.
Original Size Mixed Sizes*	Set the paper size of the original document.
Sides Off* Long edge Short edge	Specify the orientation of the original document when scanning on both sides of the document.
File Name	Specify the file name of the scanned image.
Note: An asterisk (*) next to a value indicates the factory default setting.	

Advanced Imaging

Menu item	Description
Color Balance Cyan (0*) Magenta (0*) Yellow (0*)	Adjust the color intensity for cyan, magenta, and yellow.
Color Dropout Color Dropout (None*) Default Red Threshold (128*) Default Green Threshold (128*) Default Blue Threshold (128*)	Specify which color to drop during scanning, and adjust the dropout setting for that color.
Auto Color Detect Color Sensitivity (5*) Area Sensitivity (5*) Scan Bit Depth (1 bit*) Minimum Scan Resolution (300 dpi*)	Configure the auto color detection setting.
JPEG Quality Best for content* 5–95	Set the JPEG quality of the scanned image.
Contrast Best for content* 0–5	Specify the contrast for the scanned image.
Background Removal Background Detection (Content-based*) Level (0*)	Remove the background color or image noise from the original document. Notes: <ul style="list-style-type: none"> • Content-based removes the background color from the original document. • Fixed removes image noise from a photo.
Mirror Image Off* On	Create a mirror image of the original document.
Negative Image Off* On	Create a negative image of the original document.
Shadow Detail -4 to 4 (0*)	Adjust the shadow detail in the scanned image.
Scan Edge to Edge Off* On	Scan the original document from edge to edge.
Sharpness 1–5 (3*)	Adjust the sharpness in the scanned image.
Note: An asterisk (*) next to a value indicates the factory default setting.	

Menu item	Description
Temperature -4 to 4 (0*)	Generate a bluer or redder output of the original document.
Blank Pages Blank Page Removal (Do Not Remove*) Blank Page Sensitivity (5*)	Set the sensitivity of scans in relation to blank pages in the original document.
Note: An asterisk (*) next to a value indicates the factory default setting.	

Admin Controls

Menu item	Description
Text Default 5–95 (75*)	Set the quality of text on the scanned image.
Text/Photo Default 5–95 (75*)	Set the quality of text and photo on the scanned image.
Photo Default 5–95 (50*)	Set the quality of a photo on the scanned image.
Use Multi-Page TIFF Off On*	Enable scanning of multiple TIFF images in one TIFF file.
TIFF Compression LZW* JPEG	Specify the compression type for TIFF files.
Custom Job Scanning Off* On	Set the printer to scan the first set of original documents using the specified settings, and then scan the next set with the same or different settings. Note: This menu item appears only when a hard disk or an ISD is installed.
Scan Preview Off* On	Show a scan preview of the original document. Note: This menu item appears only when a hard disk or an ISD is installed.
Adjust ADF Skew Off* On	Set the printer to adjust the skewed images from documents that are scanned from the ADF.
Note: An asterisk (*) next to a value indicates the factory default setting.	

Flash Drive Print

Menu item	Description
Number of Copies 1–9999 (1*)	Set the number of copies.
Note: An asterisk (*) next to a value indicates the factory default setting.	

Menu item	Description
Paper Source Tray [x] (1*) Multipurpose Feeder Manual Paper Manual Envelope	Set the paper source for the print job.
Color Off On*	Print a flash drive file in color.
Collate Off [1,1,1,2,2,2] On [1,2,1,2,1,2]*	Keep the pages of a print job stacked in sequence, particularly when printing multiple copies of the job.
Sides 1-Sided* 2-Sided	Specify whether to print on one side or both sides of the paper.
Flip Style Long Edge* Short Edge	Determine which side of the paper is bound when performing two-sided printing.
Pages per Side Off* 2 pages per side 3 pages per side 4 pages per side 6 pages per side 9 pages per side 12 pages per side 16 pages per side	Print multiple page images on one side of a sheet of paper.
Pages per Side Ordering Horizontal* Reverse Horizontal Reverse Vertical Vertical	Specify the positioning of multiple page images when using Pages per Side menu.
Pages per Side Orientation Auto* Landscape Portrait	Specify the orientation of multiple page images when using Pages per Side menu.
Pages per Side Border None* Solid	Print a border around each page image when using Pages per Side menu.
Note: An asterisk (*) next to a value indicates the factory default setting.	

Menu item	Description
Separator Sheets Off* Between Copies Between Jobs Between Pages	Insert blank separator sheets when printing.
Separator Sheet Source Tray [x] (1*) Multipurpose Feeder	Specify the paper source for the separator sheet.
Blank Pages Do Not Print* Print	Print blank pages in a print job.
Note: An asterisk (*) next to a value indicates the factory default setting.	

Network/Ports

Network Overview

Menu item	Description
Active Adapter Auto* Standard Network Wireless	Specify the type of the network connection. Note: Wireless is available only in printers connected to a wireless network.
Network Status	Show the connectivity status of the printer network.
Display Network Status on Printer Off On*	Show the network status on the display.
Speed, Duplex	Show the speed of the currently active network card.
IPv4	Show the IPv4 address.
All IPv6 Addresses	Show all IPv6 addresses.
Reset Print Server	Reset all active network connections to the printer. Note: This setting removes all network configuration settings.
Network Job Timeout Off On* (90 seconds)	Set the time before the printer cancels a network print job.
Banner Page Off* On	Print a banner page.
Note: An asterisk (*) next to a value indicates the factory default setting.	

Menu item	Description
Scan to PC Port Range	Specify a valid port range for printers that are behind a port blocking firewall.
Enable Network Connections Off On*	Enable the printer to connect to a network.
Enable LLDP Off* On	Enable Link Layer Discovery Protocol (LLDP) in the printer.
Note: An asterisk (*) next to a value indicates the factory default setting.	

Wireless

Note: This menu is available only in printers connected to a Wi-Fi network or printers that have a wireless network adapter.

Menu item	Description
Setup Using Mobile App	Configure the Wi-Fi connection using Lexmark Mobile Assistant.
Setup On Printer Panel Choose Network Add Wi-Fi Network Network Name Network Mode Infrastructure Wireless Security Mode Disabled* WPA2/WPA - Personal WPA2 - Personal WPA2/WPA3 - Personal WPA3 - Personal 802.1x - RADIUS	Configure the Wi-Fi connection using the control panel. Note: This menu item appears as <i>Wireless Connection Setup</i> in the Embedded Web Server.
Wi-Fi Protected Setup Start Push Button Method Start PIN Method	Establish a Wi-Fi network and enable network security. Notes: <ul style="list-style-type: none"> Start Push Button Method connects the printer to a Wi-Fi network when buttons on both the printer and the access point (wireless router) are pressed within a given time. Start PIN Method connects the printer to a Wi-Fi network when a PIN on the printer is entered into the wireless settings of the access point.
Compatibility 802.11b/g/n (2.4GHz)* 802.11a/b/g/n/ac (2.4GHz/5GHz) 802.11a/n/ac (5GHz)	Specify the standard for the Wi-Fi network. Note: 802.11a/b/g/n/ac (2.4GHz/5GHz) and 802.11a/n/ac (5GHz) only appear when a Wi-Fi option is installed.

Menu item	Description
Wireless Security Mode Disabled* WPA2/WPA-Personal WPA2-Personal WPA2/WPA3 - Personal WPA3 - Personal 802.1x - RADIUS	Set the security mode for connecting the printer to Wi-Fi devices.
WPA2/WPA Personal AES*	Enable Wi-Fi security through Wi-Fi Protected Access (WPA). Note: This menu item appears only when the Wireless Security Mode is set to WPA2/WPA-Personal.
Set PSK	Set the password for secure Wi-Fi connection.
WPA2-Personal AES*	Enable Wi-Fi security through WPA2. Note: This menu item appears only when the Wireless Security Mode is set to WPA2-Personal.
802.1x Encryption Mode WPA+ WPA2* WPA2 + PMF*	Enable Wi-Fi security through 802.1x standard. Note: This menu item appears only when the Wireless Security Mode is set to 802.1x - RADIUS.
IPv4 Enable DHCP On* Off Set Static IP Address IP Address Netmask Gateway	Enable and configure IPv4 settings in the printer.
IPv6 Enable IPv6 On* Off Enable DHCPv6 On Off* Stateless Address Autoconfiguration On* Off DNS Server Address Manually Assigned IPv6 Address Manually Assigned IPv6 Router Address Prefix All IPv6 Addresses All IPv6 Router Addresses	Enable and configure IPv6 settings in the printer.

Menu item	Description
Network Address UAA LAA	View the network addresses.
PCL SmartSwitch On* Off	Set the printer to switch automatically to PCL emulation when a print job requires it, regardless of the default printer language. Note: If PCL SmartSwitch is off, then the printer does not examine incoming data and uses the default printer language specified in the Setup menu.
PS SmartSwitch On* Off	Set the printer to switch automatically to PS emulation when a print job requires it, regardless of the default printer language. Note: If PS SmartSwitch is off, then the printer does not examine incoming data and uses the default printer language specified in the Setup menu.
Job Buffering On Off*	Temporarily store print jobs in the hard disk or intelligent storage drive (ISD) before printing. Note: This menu item appears only when a hard disk or an ISD is installed.
Mac Binary PS Auto* On Off	Set the printer to process Macintosh binary PostScript print jobs. Notes: <ul style="list-style-type: none"> • On processes raw binary PostScript print jobs. • Off filters print jobs using the standard protocol.

Wi-Fi Direct

Note: This menu is available only in printers connected to a Wi-Fi network or printers that have a wireless network adapter.

Menu item	Description
Enable Wi-Fi Direct On Off*	Set the printer to connect directly to Wi-Fi devices.
Wi-Fi Direct Name	Specify the name of the Wi-Fi Direct network.
Wi-Fi Direct Password	Set the password to authenticate and validate users on a Wi-Fi connection.
Show Password on Setup Page Off On*	Show the Wi-Fi Direct Password on the Network Setup Page.
Preferred Channel Number 1–11 Auto*	Set the preferred channel of the Wi-Fi network.
Group Owner IP Address	Specify the IP address of the group owner.
Note: An asterisk (*) next to a value indicates the factory default setting.	

Menu item	Description
Auto-Accept Push Button Requests Off* On	Accept requests to connect to the network automatically. Note: Accepting clients automatically is not secured.
Note: An asterisk (*) next to a value indicates the factory default setting.	

Mobile Services Management

Menu item	Description
Enable IPP Print On* Off	Allow printing from mobile devices using Internet Printing Protocol (IPP).
Enable IPP Fax On* Off	Allow sending faxes using Internet Printing Protocol (IPP).
Enable IPP Over USB On* Off	Allow print or scan jobs using USB connection.
Enable Scan On* Off	Allow scanning using eSCL protocol.
Enable Mopria Discovery On* Off	Allow the printer to be detected by Mopria-enabled devices.
Note: An asterisk (*) next to a value indicates the factory default setting.	

Ethernet

Menu item	Description
Network Speed	Show the speed of the active network adapter.
IPv4 Enable DHCP (On*) Set Static IP Address	Configure the IPv4 settings.
Note: An asterisk (*) next to a value indicates the factory default setting.	

Menu item	Description
IPv6 Enable IPv6 (On*) Enable DHCPv6 (Off*) Stateless Address Autoconfiguration (On*) DNS Server Address Manually Assigned IPv6 Address Manually Assigned IPv6 Router Address Prefix (64*) All IPv6 Addresses All IPv6 Router Addresses	Configure the IPv6 settings.
Network Address UAA LAA	Specify the network address.
PCL SmartSwitch Off On*	Set the printer to switch automatically to PCL emulation when a print job requires it, regardless of the default printer language. Note: When this setting is disabled, the printer does not examine incoming data and uses the default printer language specified in the Setup menu.
PS SmartSwitch Off On*	Set the printer to switch automatically to PostScript emulation when a print job requires it, regardless of the default printer language. Note: When this setting is disabled, the printer does not examine incoming data and uses the default printer language specified in the Setup menu.
Job Buffering Off* On	Temporarily store print jobs in the hard disk or intelligent storage drive (ISD) before printing. Note: This menu item appears only when a hard disk or an ISD is installed.
Mac Binary PS Auto* On Off	Set the printer to process Macintosh binary PostScript print jobs. Notes: <ul style="list-style-type: none"> • Auto processes print jobs from computers using either Windows or Macintosh operating systems. • Off filters PostScript print jobs using the standard protocol.
Energy Efficient Ethernet On Off Auto*	Reduce power consumption when the printer does not receive data from the Ethernet network.
Note: An asterisk (*) next to a value indicates the factory default setting.	

TCP/IP

Note: This menu appears only in network printers or printers attached to print servers.

Menu item	Description
Set Hostname	Set the current TCP/IP host name.
Domain Name	Set the domain name.
Allow DHCP/BOOTP to update NTP server On* Off	Allow the DHCP and BOOTP clients to update the NTP settings of the printer.
Zero Configuration Name	Specify a service name for the zero configuration network.
Enable Auto IP Off On*	Assign an IP address automatically.
DNS Server Address	Specify the current Domain Name System (DNS) server address.
Backup DNS Address	Specify the backup DNS server addresses.
Backup DNS Address 2	
Backup DNS Address 3	
Domain Search Order	Specify a list of domain names to locate the printer and its resources that reside in different domains on the network.
Enable DDNS Off* On	Update the Dynamic DNS settings.
DDNS TTL	Specify the current DDNS settings.
Default TTL	
DDNS Refresh Time	
Enable mDNS Off On*	Update the multicast DNS settings.
WINS Server Address	Specify a server address for Windows Internet Name Service (WINS).
Enable BOOTP Off* On	Allow the BOOTP to assign a printer IP address.
Restricted Server List	Specify the IP addresses that are allowed to communicate with the printer over TCP/IP. Notes: <ul style="list-style-type: none"> • Use a comma to separate each IP address. • You can add up to 50 IP addresses. • This menu item is available only in some printer models.
Note: An asterisk (*) next to a value indicates the factory default setting.	

Menu item	Description
Restricted Server List Options Block All Ports* Block Printing Only Block Printing and HTTP Only	Specify the access option for IP addresses that are not in the list. Note: This menu item is available only in some printer models.
MTU 256–1500 Ethernet (1500*)	Specify a maximum transmission unit (MTU) parameter for the TCP connections.
Raw Print Port 1–65535 (9100*)	Specify a raw port number for printers connected on a network.
Outbound Traffic Maximum Speed Off* On	Set the maximum transfer rate of the printer. Note: When enabled, the option for this setting is 100–1000000 Kilobits/second.
TLS Support Enable TLSv1.0 (Off) Enable TLSv1.1 (Off*) Enable TLSv1.2 (On*)	Enable the Transport Layer Security protocol.
SSL Cipher List	Specify the cipher algorithms to use for the SSL or the TLS connections.
TLSv1.3 SSL Cipher List	Specify the specific cipher string to use for TLS v1.3.
Note: An asterisk (*) next to a value indicates the factory default setting.	

SNMP

Note: This menu appears only in network printers or printers that are attached to print servers.

Menu item	Description
SNMP Versions 1 and 2c Enabled Off On* Allow SNMP Set Off On* Enable PPM MIB Off On* SNMP Community	Configure Simple Network Management Protocol (SNMP) versions 1 and 2c to install print drivers and applications.
Note: An asterisk (*) next to a value indicates the factory default setting.	

Menu item	Description
SNMP Version 3 Enabled Off On* Context Name Set Read/Write Credentials User Name Authentication Password Privacy Password Set Read-only Credentials User Name Authentication Password Privacy Password Authentication Hash MD5 SHA1* Minimum Authentication Level No Authentication, No Privacy Authentication, No Privacy Authentication, Privacy* Privacy Algorithm DES AES-128*	Configure SNMP version 3 to install and update the printer security.
Note: An asterisk (*) next to a value indicates the factory default setting.	

IPSec

Note: This menu appears only in network printers or printers that are attached to print servers.

Menu item	Description
Enable IPSec Off* On	Enable Internet Protocol Security (IPSec).
Base Configuration Default* Compatibility Secure	Set the IPSec base configuration. Note: This menu item appears only when Enable IPSec is set to On.
DH (Diffie-Hellman) Group Proposal modp2048 (14)* modp3072 (15) modp4096 (16) modp6144 (17)	Set the IPSec base configuration. Note: This menu item appears only when Base Configuration is set to Compatibility.
Note: An asterisk (*) next to a value indicates the factory default setting.	

Menu item	Description
Proposed Encryption Method 3DES AES*	Set the encryption method. Note: This menu item appears only when Base Configuration is set to Compatibility.
Proposed Authentication Method SHA1 SHA256* SHA512	Set the authentication method. Note: This menu item appears only when Base Configuration is set to Compatibility.
IKE SA Lifetime (Hours) 1 2 4 8 24*	Specify the IKE SA expiry period. Note: This menu item appears only when Base Configuration is set to Secure.
IPSec SA Lifetime (Hours) 1 2 4 8* 24	Specify the IPSec SA expiry period. Note: This menu item appears only when Base Configuration is set to Secure.
IPSec Device Certificate	Specify an IPSec certificate. Note: This menu item appears only when Enable IPSec is set to On.
Pre-Shared Key Authenticated Connections Host [x]	Configure the authenticated connections of the printer. Note: These menu items appear only when Enable IPSec is set to On.
Certificate Authenticated Connections Host [x] Address[/subnet]	
Note: An asterisk (*) next to a value indicates the factory default setting.	

802.1x

Note: This menu appears only in network printers or printers that are attached to print servers.

Menu item	Description
Active Off* On	Let the printer join networks that require authentication before allowing access.
Note: An asterisk (*) next to a value indicates the factory default setting.	

Menu item	Description
802.1x Authentication Device Login Name Device Login Password Validate Serve Certificate (On*) Enable Event Logging (Off*) 802.1x Device Certificate	Configure the settings for authenticating the 802.1x connection.
Authentication Mechanisms EAP - MD5 (On*) EAP - MSCHAPv2 (On*) LEAP (On*) PEAP (On*) EAP - TLS (On*) EAP - TTLS (On*) TTLS Authentication Method (MSCHAPv2*)	Configure the allowed authentication mechanisms for the 802.1x connection.
Note: An asterisk (*) next to a value indicates the factory default setting.	

LPD Configuration

Note: This menu appears only in network printers or printers that are attached to print servers.

Menu item	Description
LPD Timeout 0–65535 seconds (90*)	Set the time-out value to stop the Line Printer Daemon (LPD) server from waiting indefinitely for hung or invalid print jobs.
LPD Banner Page Off* On	Print a banner page for all LPD print jobs. Note: A banner page is the first page of a print job used as a separator of print jobs and to identify the originator of the print job request.
LPD Trailer Page Off* On	Print a trailer page for all LPD print jobs. Note: A trailer page is the last page of a print job.
LPD Carriage Return Conversion Off* On	Enable carriage return conversion. Note: Carriage return is a mechanism that commands the printer to move the position of the cursor to the first position on the same line.
Note: An asterisk (*) next to a value indicates the factory default setting.	

HTTP/FTP Settings

Menu item	Description
Proxy HTTP Proxy IP Address HTTP Default IP Port FTP Proxy IP Address FTP Default IP Port Authentication User Name Password Local Domains	Configure the HTTP and FTP server settings.
Other Settings Enable HTTP Server (On*)	Access the Embedded Web Server to monitor and manage the printer.
Other Settings Enable HTTPS (On*)	Enable Hypertext Transfer Protocol Secure (HTTPS) to encrypt data transferring to and from the print server.
Other Settings Force HTTPS Connections (Off*)	Force the printer to use HTTPS connections.
Other Settings Enable FTP/TFTP (On*)	Send files using FTP/TFTP.
Other Settings HTTPS Device Certificate (default*)	View the HTTP device certificate used on the printer.
Other Settings Timeout for HTTP/FTP Requests (30*)	Specify the amount of time before the server connection stops.
Other Settings Retries for HTTP/FTP Requests (3*)	Set the number of retries to connect to the HTTP/FTP server.
Note: An asterisk (*) next to a value indicates the factory default setting.	

ThinPrint

Menu item	Description
Enable ThinPrint Off* On	Print using ThinPrint.
Port Number 4000–4999 (4000*)	Set the port number for the ThinPrint server.
Bandwidth (bits/sec) 100–1000000 (0*)	Set the speed to transmit data in a ThinPrint environment.
Packet Size (kbytes) 0–64000 (0*)	Set the packet size for data transmission.
Note: An asterisk (*) next to a value indicates the factory default setting.	

USB

Menu item	Description
PCL SmartSwitch Off On*	Set the printer to switch to PCL emulation when a print job received through a USB port requires it, regardless of the default printer language. Note: When this setting is disabled, the printer does not examine incoming data and uses the default printer language specified in the Setup menu.
PS SmartSwitch Off On*	Set the printer to switch to PostScript emulation when a print job received through a USB port requires it, regardless of the default printer language. Note: When this setting is disabled, the printer does not examine incoming data and uses the default printer language specified in the Setup menu.
Job Buffering Off* On	Temporarily store print jobs in the hard disk or intelligent storage drive (ISD) before printing. Note: This menu item appears only when a hard disk or an ISD is installed.
Mac Binary PS Auto* On Off	Set the printer to process Macintosh binary PostScript print jobs. Notes: <ul style="list-style-type: none"> • Auto processes print jobs from computers using either Windows or Macintosh operating systems. • Off filters PostScript print jobs using the standard protocol.
Enable USB Port Off On*	Enable the front USB drive port.
Note: An asterisk (*) next to a value indicates the factory default setting.	

Restrict external network access

Menu item	Description
Restrict external network access Off* On	Restrict access to network sites.
External network address	Specify the network addresses with restricted access.
E-mail address for notification	Specify an e-mail address to send a notification of logged events.
Ping frequency 1–300 (10*)	Specify the network query interval in seconds.
Subject	Specify the subject and message of the notification e-mail.
Message	
Note: An asterisk (*) next to a value indicates the factory default setting.	

Security

Login Methods

Manage Permissions

Menu item	Description
<p>Function Access</p> <ul style="list-style-type: none"> Access Address Book in Apps Modify Address Book Manage Shortcuts Create Profiles Manage Bookmarks Flash Drive Print Flash Drive Color Printing Flash Drive Scan Copy Function Copy Color Printing Color Dropout E-mail Function Fax Function FTP Function Release Held Faxes Held Jobs Access Use Profiles Cancel Jobs at the Device Change Language Internet Printing Protocol (IPP) Initiate Scans Remotely B/W Print Color Print Network Folder - Scan Hard Disk - Print Hard Disk - Color Print Hard Disk - Scan 	<p>Control access to the printer functions.</p> <p>Note: Some menu items appear only when a hard disk or an intelligent storage drive is installed.</p>
<p>Administrative Menus</p> <ul style="list-style-type: none"> Security Menu Network/Ports Menu Paper Menu Reports Menu Function Configuration Menus Supplies Menu Option Card Menu SE Menu Device Menu 	<p>Control access to the printer menu settings.</p>

Menu item	Description
Device Management Remote Management Firmware Updates Apps Configuration Operator Panel Lock Embedded Web Server Access Import / Export All Settings Out of Service Erase Cloud Services Enrollment	Control access to the printer management options.
Apps New Apps Slideshow Change Wallpaper Screen Saver Card Copy Scan Center Scan Center Custom [x]	Control access to printer applications.

Local Accounts

Menu item	Description
Manage Groups/Permissions Add Group Import Access Controls Function Access Administrative Menus Device Management Apps All Users Import Access Controls Function Access Administrative Menus Device Management Apps Admin	Control group or user access to the printer functions, applications, and security settings.

Menu item	Description
Add User User Name/Password User Name Password PIN	Create local accounts to manage access to the printer functions.
User Name/Password Accounts Add User	
User Name Accounts Add User	
Password Accounts Add User	
PIN Accounts Add User	

Default Login Methods

Note: This menu appears only when you configure the settings in the Local Accounts menu.

Menu item	Description
Control Panel User Name/Password User Name Password PIN	Specify the default login method to access the control panel.
Browser User Name/Password User Name Password PIN	Specify the default login method to access the browser.

Schedule USB Devices

Menu item	Description
Schedules Add New Schedule	Schedule access to the front USB port.

Security Audit Log

Menu item	Description
Enable Audit Off* On	Record the events in the secure audit log and remote syslog.
Enable Remote Syslog Off* On	Send audit logs to a remote server.
Remote Syslog Server	Specify the remote syslog server.
Remote Syslog Port 1–65535 (514*)	Specify the remote syslog port.
Remote Syslog Method Normal UDP* Stunnel	Specify a syslog method to transmit logged events to a remote server.
Remote Syslog Facility 0 - Kernel Messages 1 - User-Level Messages 2 - Mail System 3 - System Daemons 4 - Security/Authorization Messages* 5 - Messages Generated Internally by Syslogs 6 - Line Printer Subsystem 7 - Network News Subsystem 8 - UUCP Subsystem 9 - Clock Daemon 10 - Security/Authorization Messages 11 - FTP Daemon 12 - NTP Subsystem 13 - Log Audit 14 - Log Alert 15 - Clock Daemon 16 - Local Use 0 (local0) 17 - Local Use 1 (local1) 18 - Local Use 2 (local2) 19 - Local Use 3 (local3) 20 - Local Use 4 (local4) 21 - Local Use 5 (local5) 22 - Local Use 6 (local6) 23 - Local Use 7 (local7)	Specify a facility code that the printer uses when sending log events to a remote server.
Note: An asterisk (*) next to a value indicates the factory default setting.	

Menu item	Description
Severity of Events to Log 0 - Emergency 1 - Alert 2 - Critical 3 - Error 4 - Warning* 5 - Notice 6 - Informational 7 - Debug	Specify the priority level cutoff for logging messages and events.
Remote Syslog Non-Logged Events Off* On	Send all events, regardless of severity level, to the remote server.
Admin's E-mail Address	Send e-mail notification of logged events to the administrator.
E-mail Log Cleared Alert Off* On	Send e-mail notification to the administrator when a log entry is deleted.
E-mail Log Wrapped Alert Off* On	Send e-mail notification to the administrator when the log becomes full and begins to overwrite the oldest entries.
Log Full Behavior Wrap Over Oldest Entries* E-mail Log Then Delete All Entries	Resolve log storage issues when the log fills its allotted memory.
E-mail % Full Alert Off* On	Send e-mail notification to the administrator when the log fills its allotted memory.
% Full Alert Level 1–99 (90*)	
E-mail Log Exported Alert Off* On	Send e-mail notification to the administrator when a log is exported.
E-mail Log Settings Changed Alert Off* On	Send e-mail notification to the administrator when Enable Audit is set.
Log Line Endings LF (\n)* CR (\r) CRLF (\r\n)	Specify how the log file terminates the end of each line.
Note: An asterisk (*) next to a value indicates the factory default setting.	

Menu item	Description
Digitally Sign Exports Off* On	Add a digital signature to each exported log file.
Clear Log	Delete all audit logs.
Export Log Syslog (RFC 5424) Syslog (RFC 3164) CSV	Export a security log to a flash drive.
Note: An asterisk (*) next to a value indicates the factory default setting.	

Login Restrictions

Menu item	Description
Login failures 1–10 (3*)	Specify the number of failed login attempts before the user gets locked out.
Failure time frame 1–60 minutes (5*)	Specify the time frame between failed login attempts before the user gets locked out.
Lockout time 1–60 minutes (5*)	Specify the lockout duration.
Web Login Timeout 1–120 minutes (10*)	Specify the delay for a remote login before the user is logged off automatically.
Note: An asterisk (*) next to a value indicates the factory default setting.	

Confidential Print Setup

Menu item	Description
Max Invalid PIN 2–10	Set the limit for entering an invalid PIN. Note: When the limit is reached, the print jobs for that user name are deleted.
Confidential Job Expiration Off* 1 Hour 4 Hours 24 Hours 1 Week	Set an individual expiration time for each held job before it is automatically deleted from the hard disk or intelligent storage drive. Note: A held job is either Confidential, Repeat, Reserve, or Verify.
Note: An asterisk (*) next to a value indicates the factory default setting.	

Menu item	Description
Repeat Job Expiration Off* 1 Hour 4 Hours 24 Hours 1 Week	Set the expiration time for a print job that you want to repeat.
Verify Job Expiration Off* 1 Hour 4 Hours 24 Hours 1 Week	Set the expiration time for printing a copy of a job for you to check its quality before printing the remaining copies.
Reserve Job Expiration Off* 1 Hour 4 Hours 24 Hours 1 Week	Set the expiration time for jobs that you want to store in the printer for printing later.
Require All Jobs to be Held Off* On	Set the printer to hold all print jobs.
Keep duplicate documents Off* On	Set the printer to keep all documents with the same file name.
Note: An asterisk (*) next to a value indicates the factory default setting.	

Disk Encryption

Note: This menu appears only when a hard disk or an intelligent storage drive is installed.

Menu item	Description
Status Enabled	Encryption happens automatically when a storage drive is installed.

Erase Temporary Data Files

Menu item	Description
Stored in onboard memory Off* On	Delete all files stored on the printer memory.
Note: An asterisk (*) next to a value indicates the factory default setting.	

Menu item	Description
Stored on hard disk 1 Pass Erase* 3 Pass Erase 7 Pass Erase	Delete all files stored on the printer hard disk. Note: This menu item appears only when a printer hard disk is installed.
Note: An asterisk (*) next to a value indicates the factory default setting.	

Solutions LDAP Settings

Menu item	Description
Follow LDAP Referrals Off* On	Search the different servers in the domain for the logged-in user account.
LDAP Certificate Verification Yes No*	Enable verification of LDAP certificates.

Miscellaneous

Menu item	Description
Protected Features Show* Hide	Show all the features that Function Access Control (FAC) protects regardless of the security permission that the user has. Note: Hide displays only FAC-protected features that the user has access.
Print Permission Off* On	Let the user log in before printing.
Default Print Permission Login User Name/Password* User Name	Set the default login for Print Permission.
Security Reset Jumper Enable "Guest" access* No Effect	Specify user access to the printer. Notes: <ul style="list-style-type: none"> • Enable "Guest" access provides anyone access to all aspects of the printer. • No Effect may make access to the printer impossible when the required security information is unavailable.
Reset Device Modes Allow with FAC Allow* Don't allow	Specify user access to the Out of Service Erase menu.
Note: An asterisk (*) next to a value indicates the factory default setting.	

Menu item	Description
Use Intelligent Storage Drive for User Data Off On*	Enable intelligent storage drive to store user data.
Minimum Password Length 0–32 (0*)	Specify the password length.
Enable Password/PIN Reveal Off* On	Show the password or personal identification number.
Note: An asterisk (*) next to a value indicates the factory default setting.	

Cloud Services

Cloud Services Enrollment

Menu item	Description
View More Information	View additional information on the usage of Lexmark Cloud Services.
Enable communication with Lexmark Cloud Services Off* On	Enable the printer to communicate with Lexmark Cloud Services.
View Current Status	View the connection status between the printer and Lexmark Cloud Services.
Note: An asterisk (*) next to a value indicates the factory default setting.	

Reports

Menu Settings Page

Menu item	Description
Menu Settings Page	Print a report that contains the printer menus.

Device

Device

Menu item	Description
Device Information	Print a report that contains information about the printer.

Menu item	Description
Device Statistics	Print a report about printer usage and supply status.
Profiles List	Print a list of profiles that are stored in the printer.
Asset Report	Print a diagnostic tool for print problems. Note: To avoid clipping the content, print the report on letter- or A4-size paper.

Print

Menu item	Description
Print Fonts PCL Fonts PS Fonts	Print samples and information about the fonts that are available in each printer language.
Print Demo Demo Page	Print a page that shows the printer capabilities and supported solutions.
Print Directory	Print the resources that are stored in the flash drive, hard disk, or intelligent storage drive (ISD). Note: This menu item appears only when a flash drive, a hard disk, or an ISD is installed.

Shortcuts

Menu item	Description
All Shortcuts	Print a report that lists the shortcuts that are stored in the printer.
Fax Shortcuts	Note: Fax Shortcuts appears only when fax is installed.
Copy Shortcuts	
E-mail Shortcuts	
FTP Shortcuts	
Network Folder Shortcuts	

Fax

Note: This menu appears only if Fax is configured, and Enable Job Log is set to On.

Menu item	Description
Fax Job Log	Print a report about the last 200 completed fax jobs.
Fax Call Log	Print a report about the last 100 attempted, received, and blocked calls.

Network

Menu item	Description
Network Setup Page	Print a page that shows the configured network and wireless settings on the printer. Note: This menu item appears only in network printers or printers connected to print servers.
Wi-Fi Direct Connected Clients	Print a page that shows the list of devices that are connected to the printer using Wi-Fi Direct. Note: This menu item appears only when Enable Wi-Fi Direct is set to On.

Troubleshooting

Menu item	Description
Print Quality Test Pages	Print sample pages to identify and correct print quality defects.
Cleaning the Scanner	Print instructions on how to clean the scanner.

Printing the Menu Settings Page

From the home screen, touch **Settings > Reports > Menu Settings Page**.

Maintain the printer

Checking the status of parts and supplies

- 1 From the home screen, touch **Status/Supplies**.
- 2 Select the parts or supplies that you want to check.

Note: You can also access this setting by touching the top section of the home screen.

Configuring supply notifications

- 1 Open a web browser, and then type the printer IP address in the address field.

Notes:

- View the printer IP address on the printer home screen. The IP address appears as four sets of numbers separated by periods, such as 123.123.123.123.
- If you are using a proxy server, then temporarily disable it to load the web page correctly.

- 2 Click **Settings > Device > Notifications**.
- 3 From the Supplies menu, click **Custom Supply Notifications**.
- 4 Select a notification for each supply item.
- 5 Apply the changes.

Setting up e-mail alerts

Configure the printer to send e-mail alerts when supplies are low, when paper must be changed or added, or when there is a paper jam.

- 1 Open a web browser, and then type the printer IP address in the address field.

Notes:

- View the printer IP address on the printer home screen. The IP address appears as four sets of numbers separated by periods, such as 123.123.123.123.
- If you are using a proxy server, then temporarily disable it to load the web page correctly.

- 2 Click **Settings > Device > Notifications > E-mail Alert Setup**, and then configure the settings.

Note: For more information on SMTP settings, contact your e-mail provider.
- 3 Apply the changes.
- 4 Click **Setup E-mail Lists and Alerts**, and then configure the settings.
- 5 Apply the changes.

Viewing reports

- 1 From the home screen, touch **Settings** > **Reports**.
- 2 Select the report that you want to view.

Ordering parts and supplies

To order supplies in the U.S., contact Lexmark at 1-800-539-6275 for information about Lexmark authorized supplies dealers in your area. In other countries or regions, go to www.lexmark.com or contact the place where you purchased the printer.

Note: All life estimates for printer supplies assume printing on letter- or A4-size plain paper.

Warning—Potential Damage: Failure to maintain optimum printer performance, or to replace parts and supplies, may cause damage to your printer.

Using genuine Lexmark parts and supplies

Your Lexmark printer is designed to function best with genuine Lexmark parts and supplies. Use of third-party supplies or parts may affect the performance, reliability, or life of the printer and its imaging components. It can also affect warranty coverage. Damage caused by the use of third-party parts and supplies is not covered by the warranty. All life indicators are designed to function with Lexmark parts and supplies, and may deliver unpredictable results if third-party parts and supplies are used. Imaging component usage beyond the intended life may damage your Lexmark printer or its associated components.

Warning—Potential Damage: Supplies and parts without Return Program agreement terms may be reset and remanufactured. However, the manufacturer's warranty does not cover any damage caused by non-genuine supplies or parts. Resetting counters on the supply or part without proper remanufacturing can cause damage to your printer. After resetting the supply or part counter, your printer may display an error indicating the presence of the reset item.

Ordering a toner cartridge

Notes:

- The estimated cartridge yield is based on the ISO/IEC 19798 standard.
- Extremely low print coverage for extended periods of time may negatively affect actual yield.

Lexmark CX730 and Lexmark CX735 Return Program cartridges

Item	North America	Europe	Rest of the World
Return Program toner cartridges			
Cyan	71C10C0	71C20C0	71C80C0
Magenta	71C10M0	71C20M0	71C80M0
¹ Supported only in the Lexmark CX730 printer model. ² Supported only in the Lexmark CX735 printer model. For more information on countries in each region, go to www.lexmark.com/regions .			

Item	North America	Europe	Rest of the World
Yellow	71C10Y0	71C20Y0	71C80Y0
Black	71C10K0	71C20K0	71C80K0
High Yield Return Program toner cartridges¹			
Cyan	71C1HC0	71C2HC0	71C8HC0
Magenta	71C1HM0	71C2HM0	71C8HM0
Yellow	71C1HY0	71C2HY0	71C8HY0
Black	71C1HK0	71C2HK0	71C8HK0
Extra High Yield Return Program toner cartridges²			
Cyan	81C1XC0	81C2XC0	81C8XC0
Magenta	81C1XM0	81C2XM0	81C8XM0
Yellow	81C1XY0	81C2XY0	81C8XY0
Black	81C1XK0	81C2XK0	81C8XK0
¹ Supported only in the Lexmark CX730 printer model. ² Supported only in the Lexmark CX735 printer model. For more information on countries in each region, go to www.lexmark.com/regions .			

Lexmark CX730 High yield toner cartridges

Item	Worldwide
Cyan	71C0H20
Magenta	71C0H30
Yellow	71C0H40
Black	71C0H10

Lexmark CX735 Extra high yield toner cartridges

Item	Worldwide
Cyan	81C0X20
Magenta	81C0X30
Yellow	81C0X40
Black	81C0X10

Lexmark XC4342 and Lexmark XC4352 Toner cartridges

Item	Worldwide
Cyan	24B7515
Magenta	24B7516
Yellow	24B7517



Item	Worldwide
Black	24B7518

Ordering black imaging unit

Item	Part number
Black imaging unit	71C0Z10

Ordering color imaging kit

Item	Part number
Color imaging kit	71C0Z50

Ordering a waste toner bottle

Item	Part number
Waste toner bottle	71C0W00

Ordering a fuser maintenance kit

Notes:

- Using certain types of paper requires more frequent replacement of the maintenance kit.
- The separator assembly, fuser, and pick roller assembly are included in the maintenance kit and can be ordered individually and replaced if necessary.
- For more information on replacing the maintenance kit, see the documentation that came with the kit.

Item	Part number
Fuser maintenance kit, 110–120 V	41X3882
Fuser maintenance kit, 220–240 V	41X3883
Fuser maintenance kit, 100 V	41X3884
Fuser maintenance kit, 115 V (Narrow media)*	41X4511

* Supported only in and required for Lexmark CX737.



Replacing parts and supplies

Replacing a toner cartridge

- 1 Open door B.

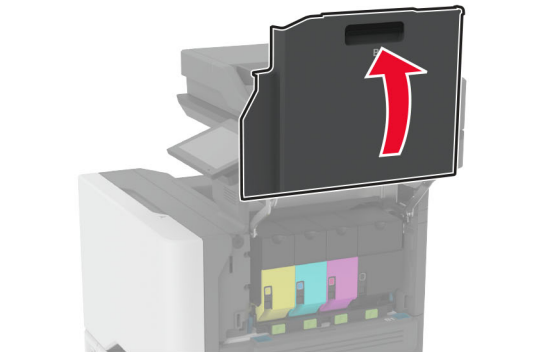
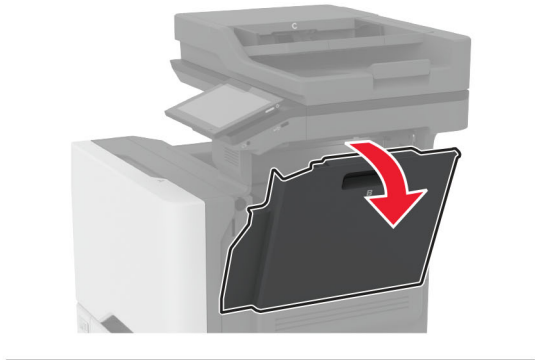
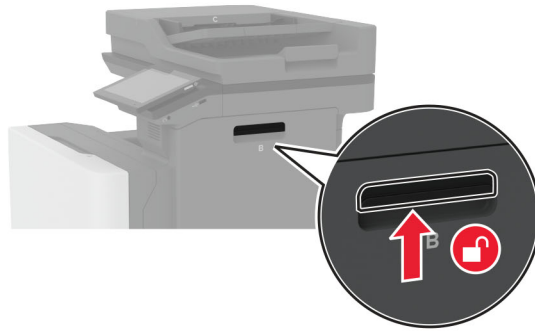

2 Remove the used toner cartridge.

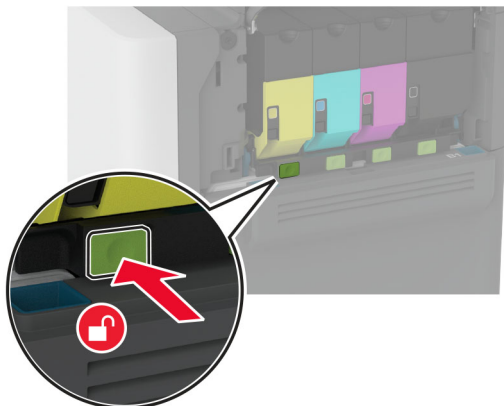

3 Unpack the new toner cartridge.

4 Insert the new toner cartridge.

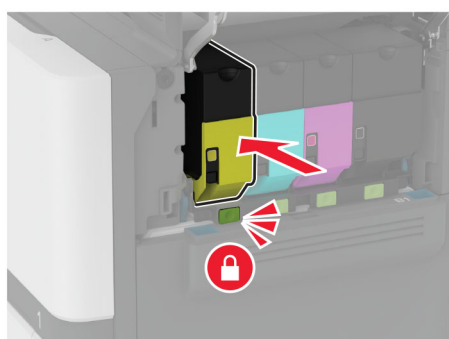
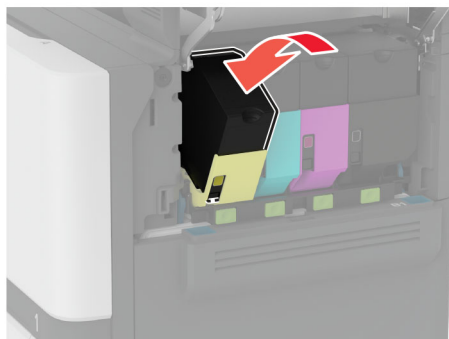

5 Close door B.

Replacing the black imaging unit

- 1 Open door B.

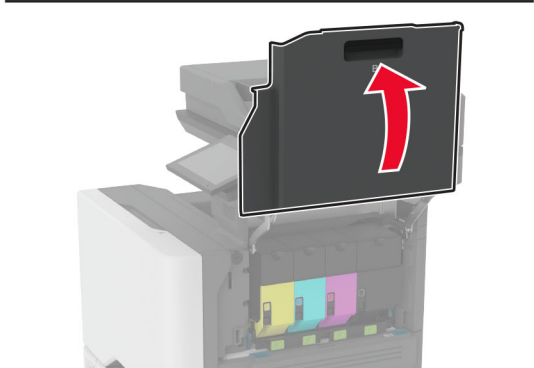
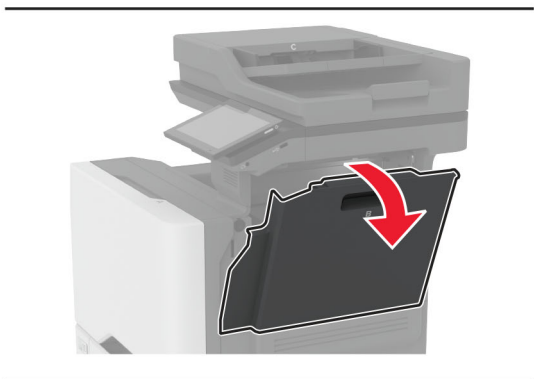
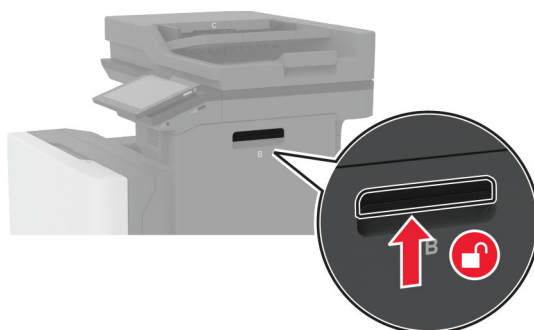

2 Remove the waste toner bottle.

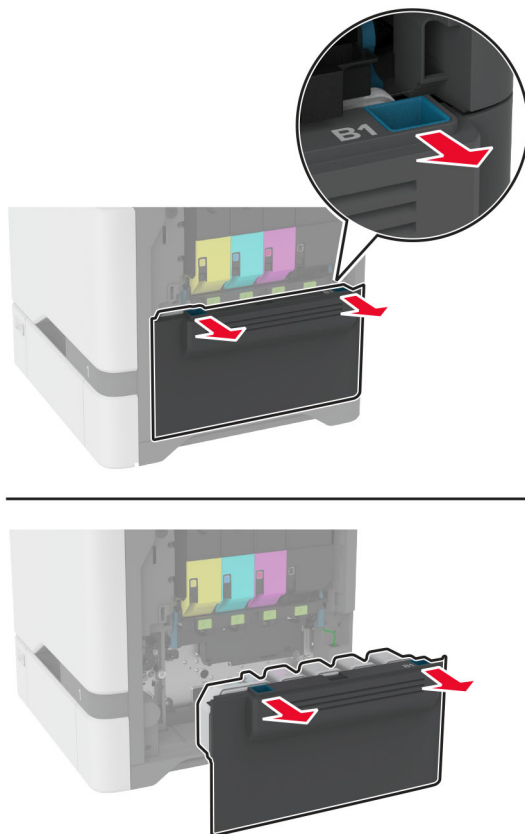

Note: To avoid spilling the toner, place the bottle in an upright position.

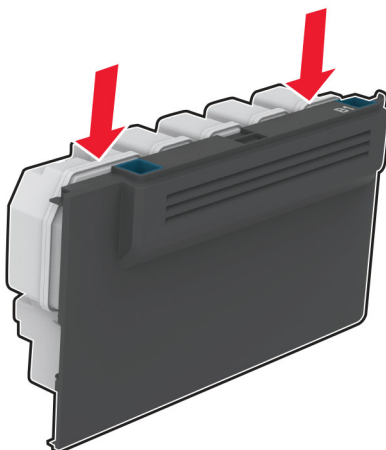

3 Remove the toner cartridges.

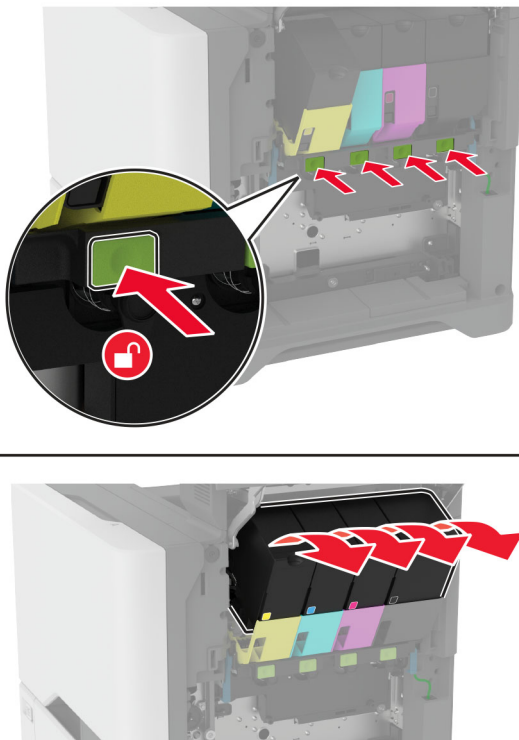

4 Disconnect the imaging kit cable.

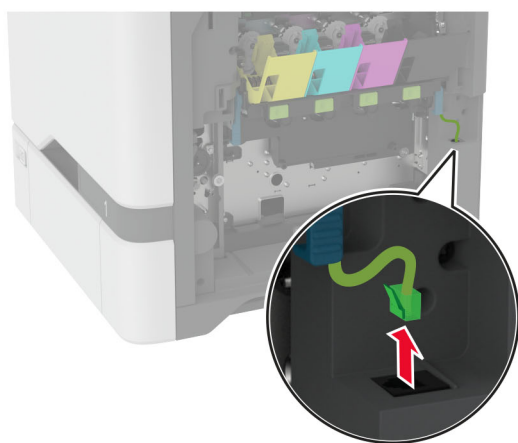
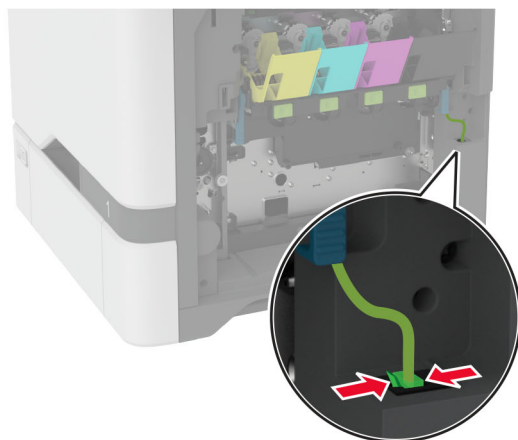

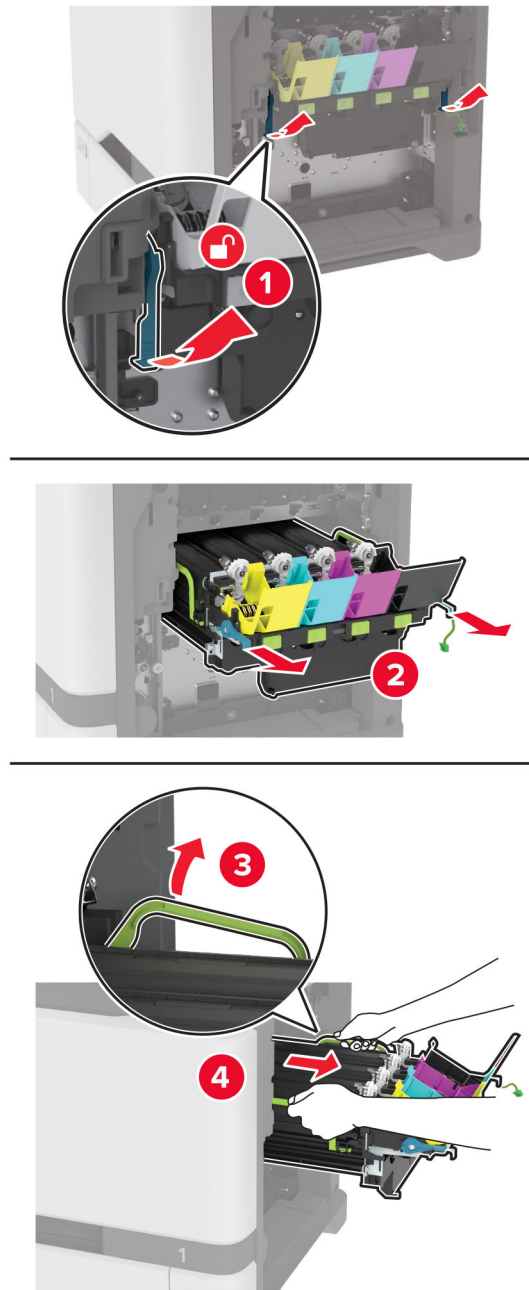
5 Remove the imaging kit.

Note: To avoid scratching the imaging kit or damaging the photoconductor drum, place the imaging kit in an uplifted position.

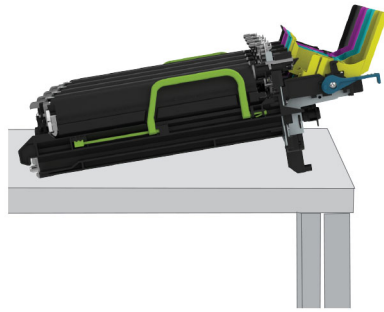

6 Remove the used black imaging unit.

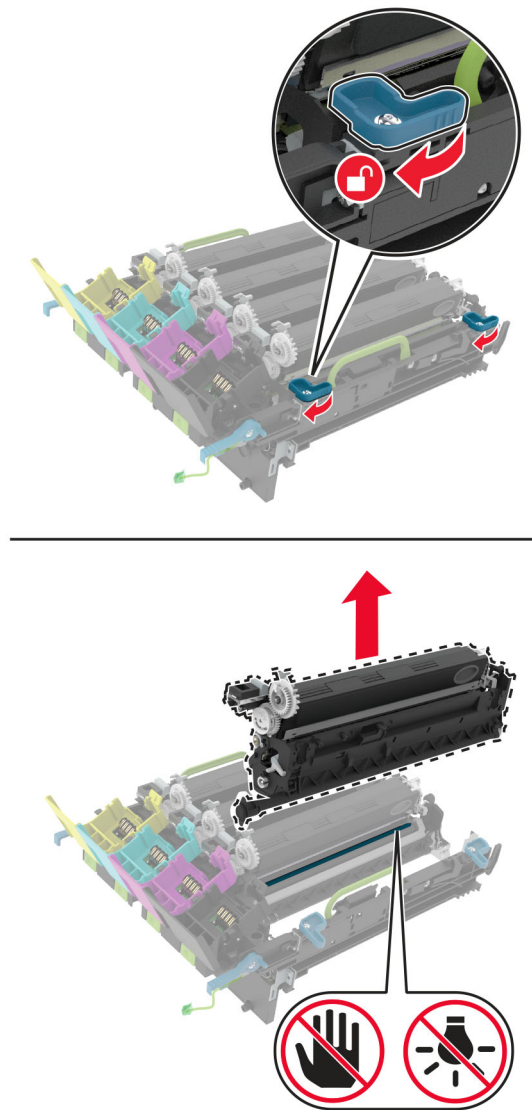

Warning—Potential Damage: Do not expose the photoconductor unit to direct light for more than 10 minutes. Extended exposure to light may cause print quality problems.

Warning—Potential Damage: Do not touch the shiny photoconductor drum under the imaging kit. Doing so may affect the quality of future print jobs.

- 7 Unpack the new black imaging unit.
- 8 Insert the new black imaging unit into the imaging kit.

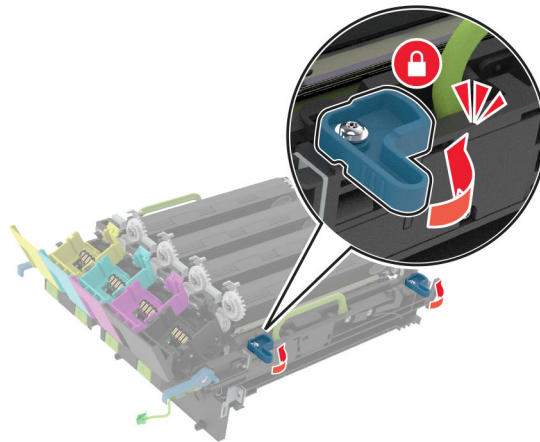
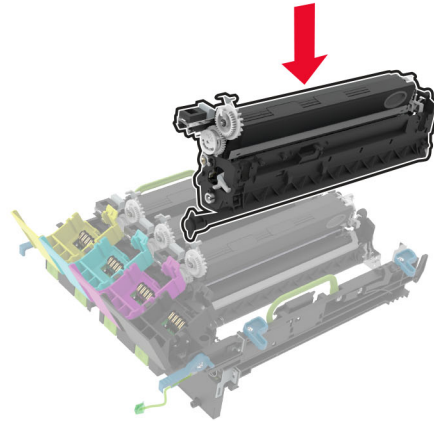

9 Insert the imaging kit.

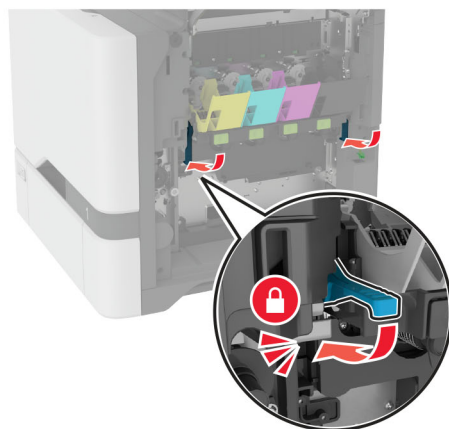
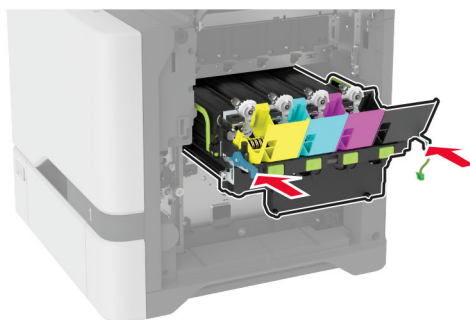
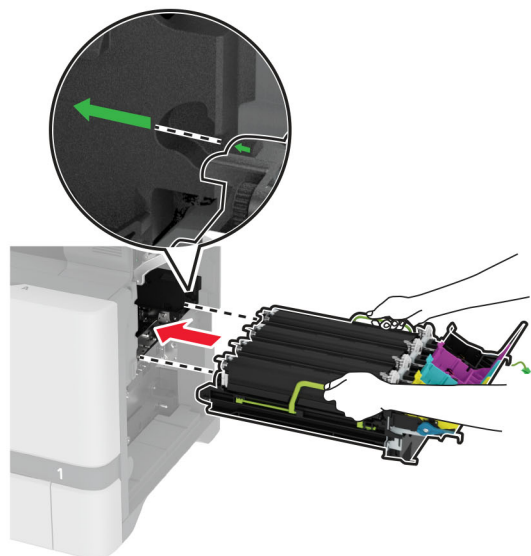

10 Connect the imaging kit cable.

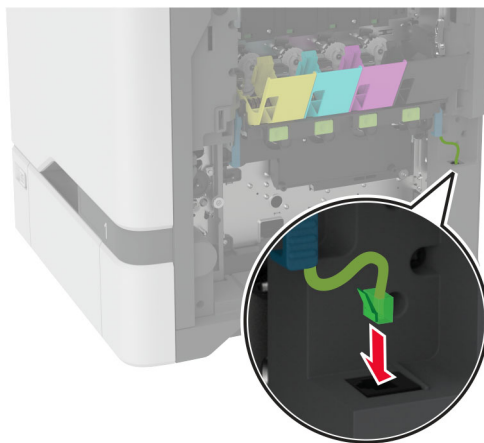

11 Insert the waste toner bottle.

12 Insert the toner cartridges.

13 Close door B.

Replacing the color imaging kit

- 1 Open door B.

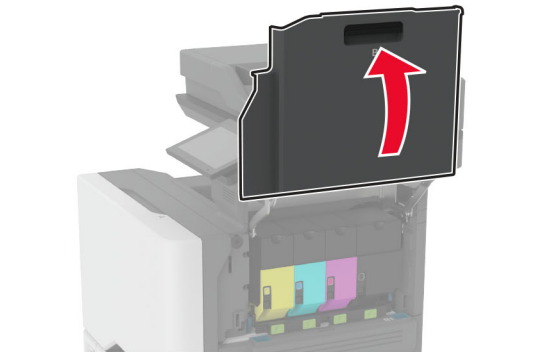
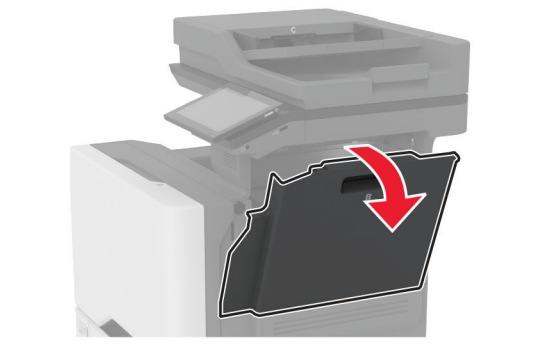
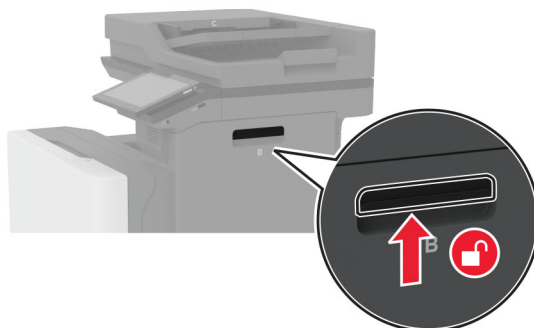

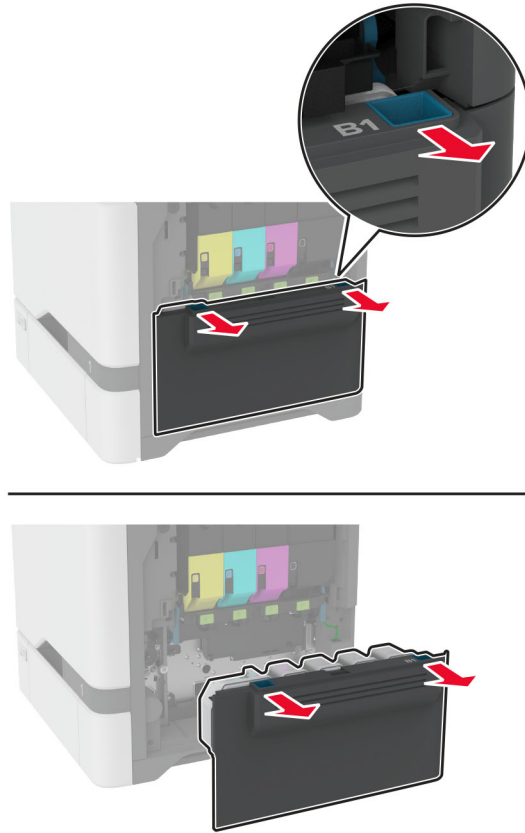
2 Remove the waste toner bottle.

Note: To avoid spilling the toner, place the bottle in an upright position.

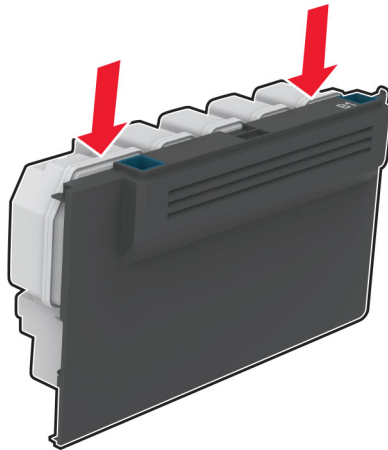

3 Remove the toner cartridges.

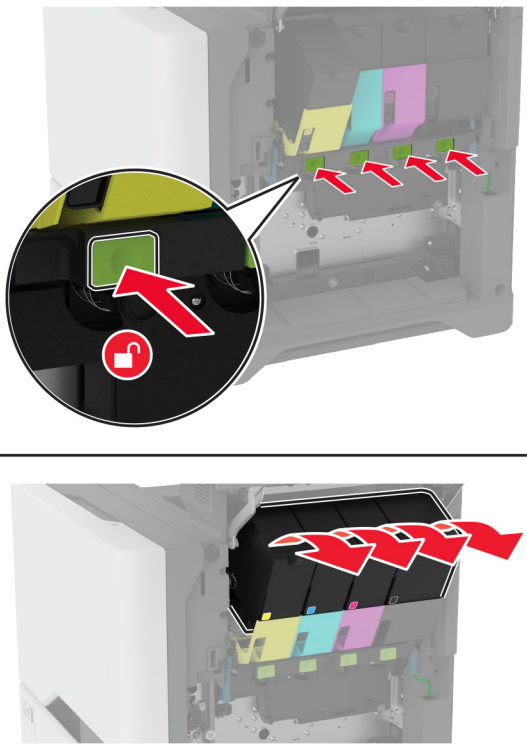

4 Disconnect the imaging kit cable.

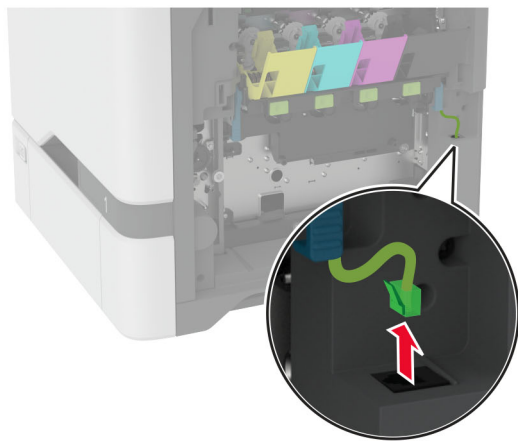
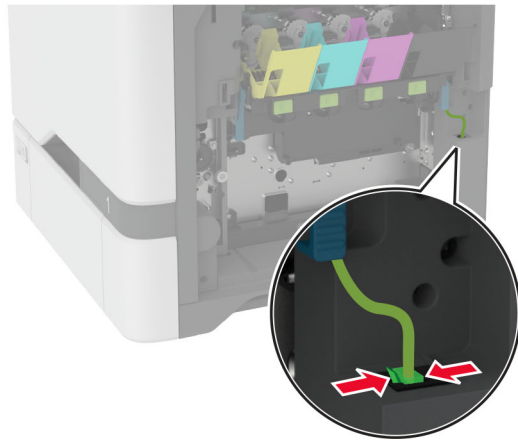

5 Remove the used imaging kit.

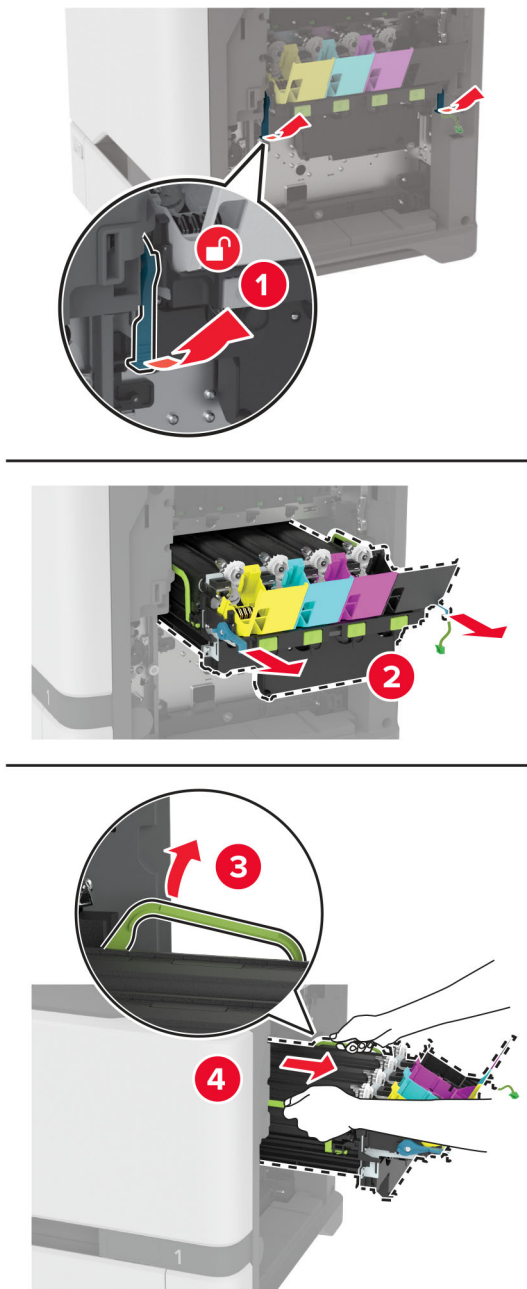

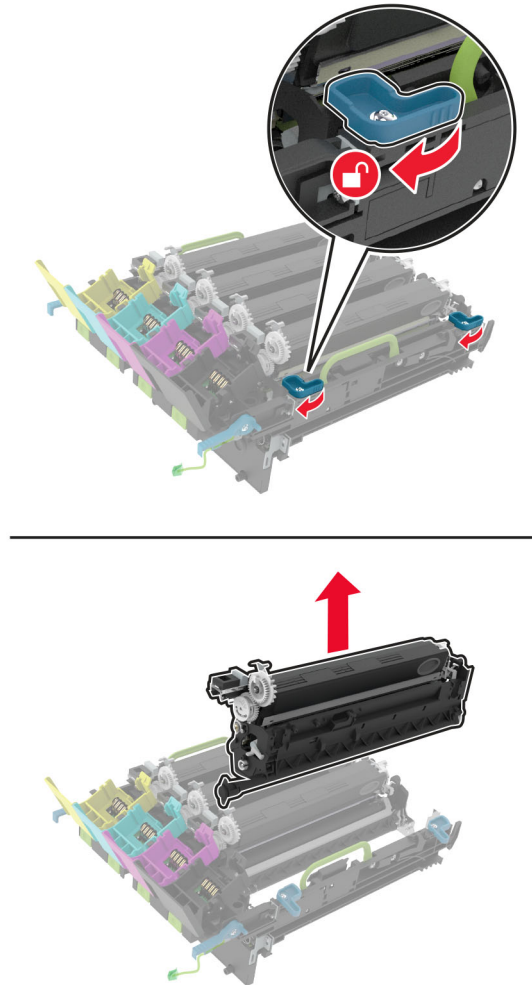
6 Remove the black imaging unit.

Warning—Potential Damage: Do not expose the photoconductor unit to direct light for more than 10 minutes. Extended exposure to light may cause print quality problems.

Warning—Potential Damage: Do not touch the shiny photoconductor drum under the imaging unit. Doing so may affect the quality of future print jobs.

**7** Unpack the new imaging kit.

Note: The imaging kit includes the imaging kit and the cyan, magenta, and yellow developer units.

8 Insert the black imaging unit into the new imaging kit.

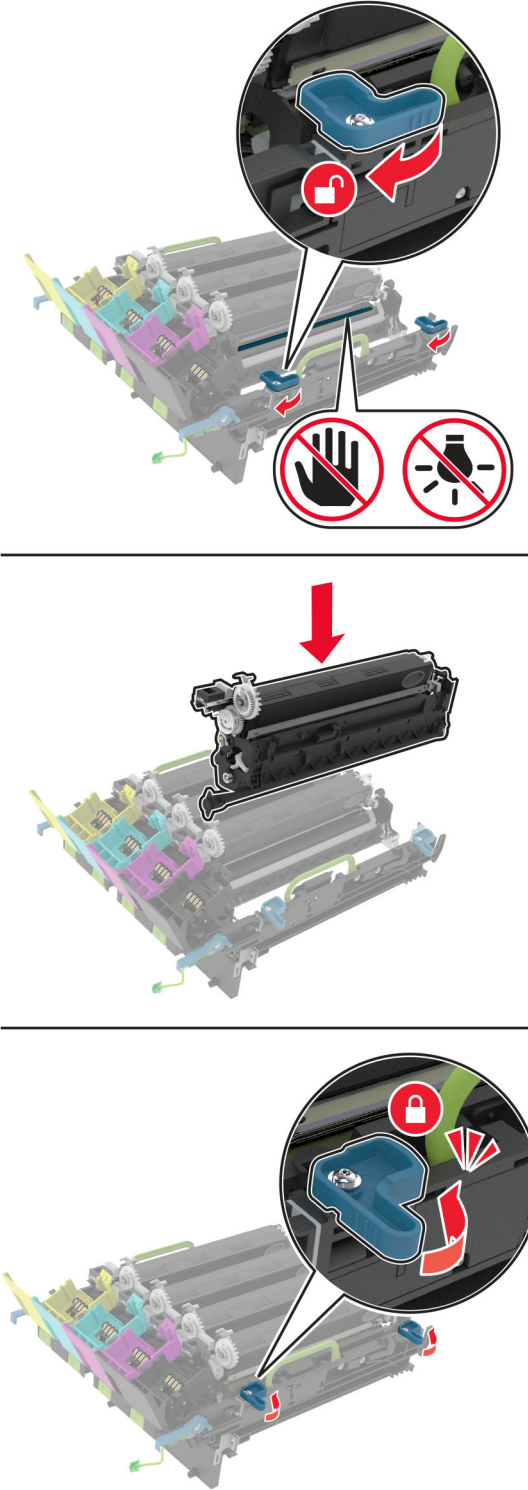

9 Insert the new imaging kit.

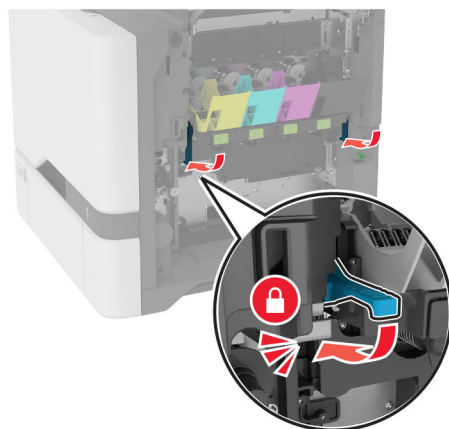
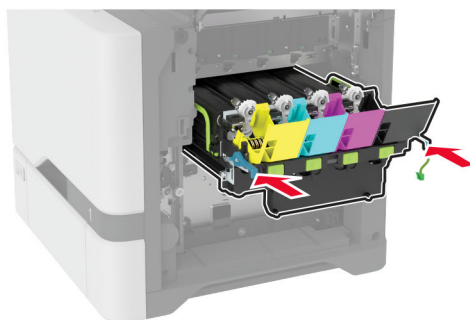
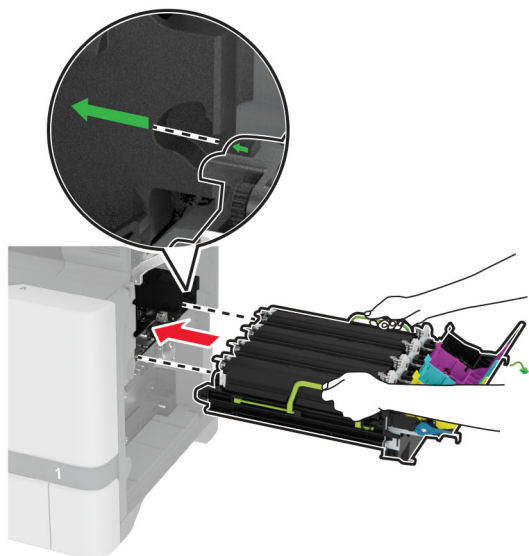

10 Connect the imaging kit cable.

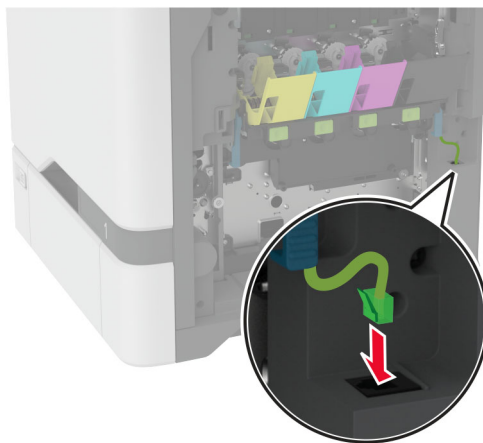

11 Insert the waste toner bottle.

12 Insert the toner cartridges.

13 Close door B.

Replacing the waste toner bottle

- 1 Open door B.

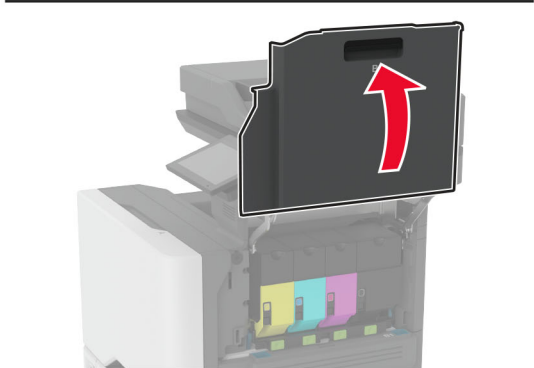
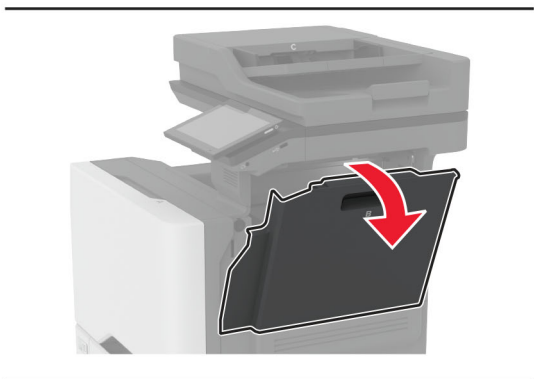
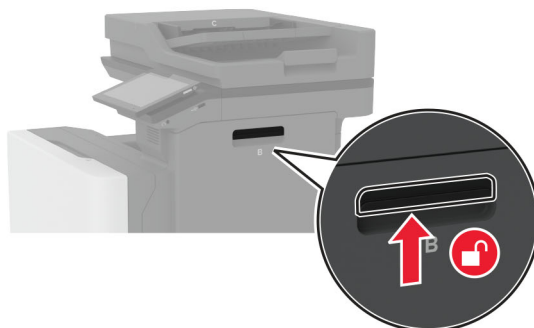

- 2 Remove the used waste toner bottle.

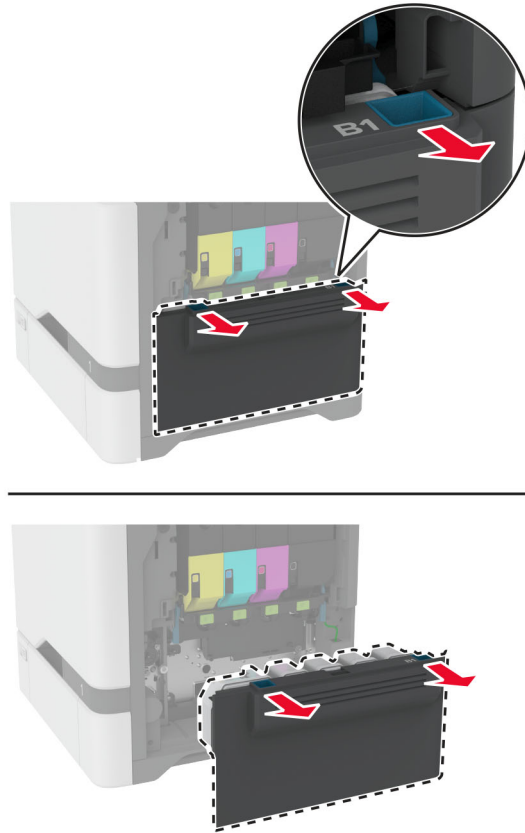

Note: To avoid spilling the toner, place the bottle in an upright position.

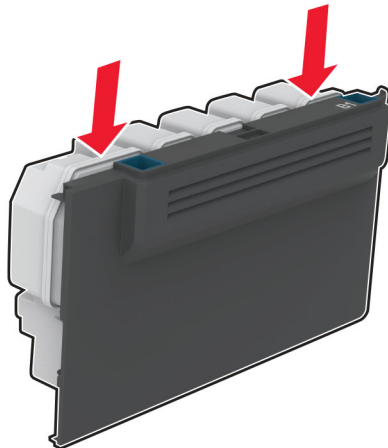

- 3 Unpack the new waste toner bottle.
- 4 Insert the new waste toner bottle.
- 5 Close door B.
- 6 Dispose the used waste toner bottle properly.

Replacing the fuser

- 1 Turn off the printer, and then unplug the power cord from the electrical outlet.
- 2 Open door A, and then open door A1.

 **CAUTION—HOT SURFACE:** The inside of the printer might be hot. To reduce the risk of injury from a hot component, allow the surface to cool before touching it.

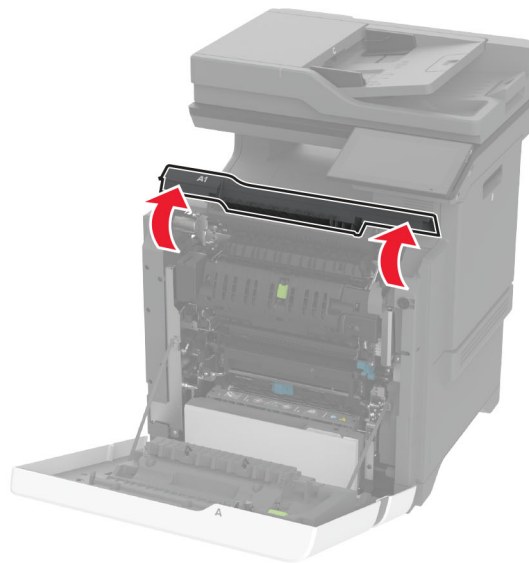
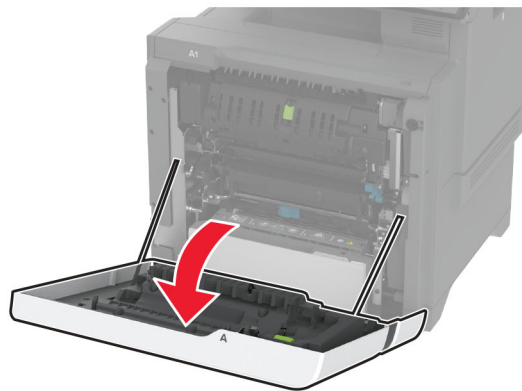

3 Remove the used fuser.

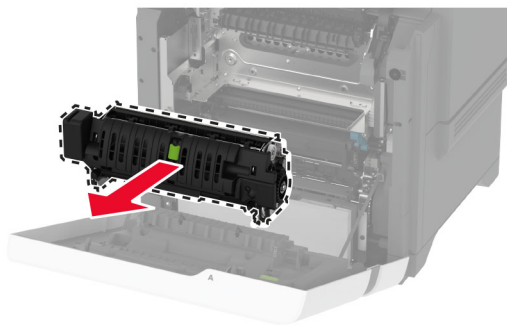
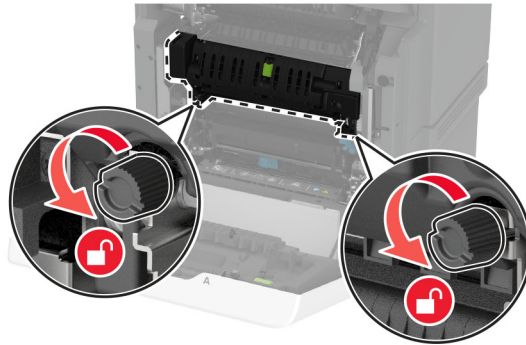

4 Unpack the new fuser.

5 Insert the new fuser.

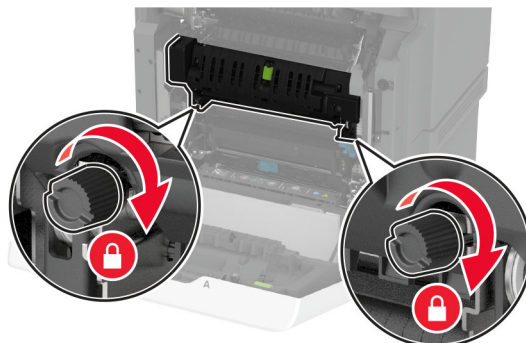
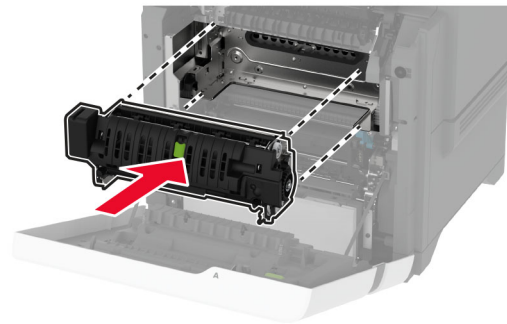

6 Close door A1, and then close door A.

7 Connect the power cord to the electrical outlet, and then turn on the printer.

⚠ CAUTION—POTENTIAL INJURY: To avoid the risk of fire or electrical shock, connect the power cord to an appropriately rated and properly grounded electrical outlet that is near the product and easily accessible.

8 Reset the fuser maintenance counter.

For more information, see [“Resetting the maintenance counter” on page 248](#).

Replacing the pick roller

Replacing the pick roller in the 550-sheet tray

1 Turn off the printer, and then unplug the power cord from the electrical outlet.

2 Remove the tray.

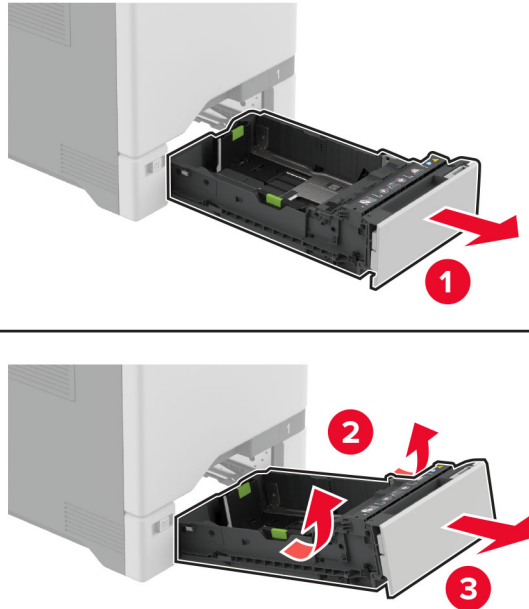

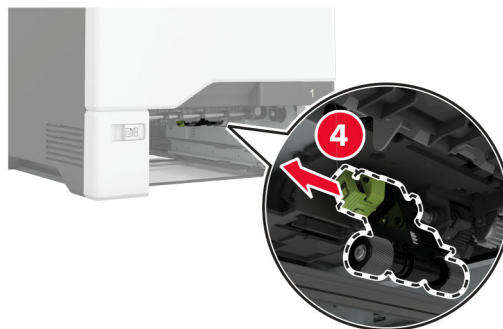
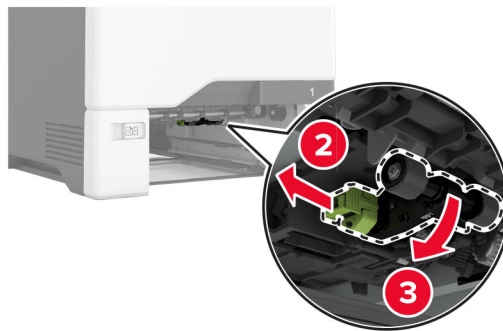
3 Remove the used pick roller.**4** Unpack the new pick roller.

Warning—Potential Damage: To avoid damage and poor printer performance, make sure that your hands are clean when handling the parts.

- 5 Insert the new pick roller.



- 6 Insert the tray.
- 7 Connect the power cord to the electrical outlet, and then turn on the printer.

CAUTION—POTENTIAL INJURY: To avoid the risk of fire or electrical shock, connect the power cord to an appropriately rated and properly grounded electrical outlet that is near the product and easily accessible.

Replacing the pick roller in the multipurpose feeder

- 1 Turn off the printer, and then unplug the power cord from the electrical outlet.
- 2 Open the multipurpose feeder.

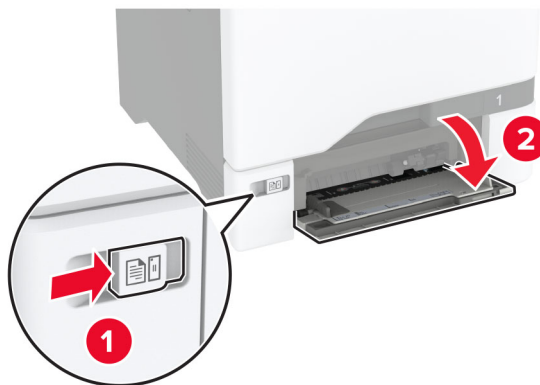

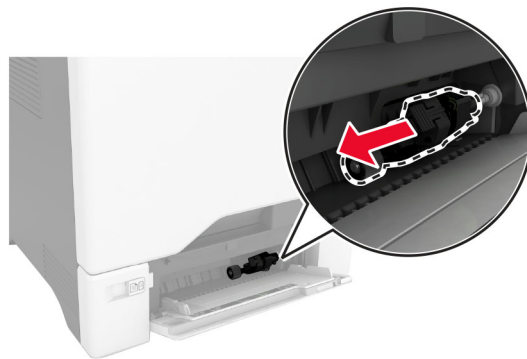
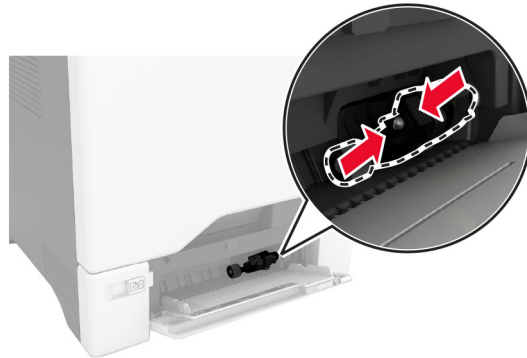
3 Remove the used pick roller.**4** Unpack the new pick roller.

Warning—Potential Damage: To avoid damage and poor printer performance, make sure that your hands are clean when handling the parts.

5 Insert the new pick roller.

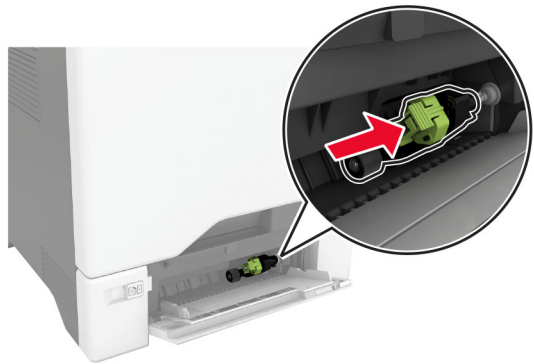

6 Close the multipurpose feeder.

7 Connect the power cord to the electrical outlet, and then turn on the printer.

CAUTION—POTENTIAL INJURY: To avoid the risk of fire or electrical shock, connect the power cord to an appropriately rated and properly grounded electrical outlet that is near the product and easily accessible.

Replacing the separator bracket

1 Pull out the tray.

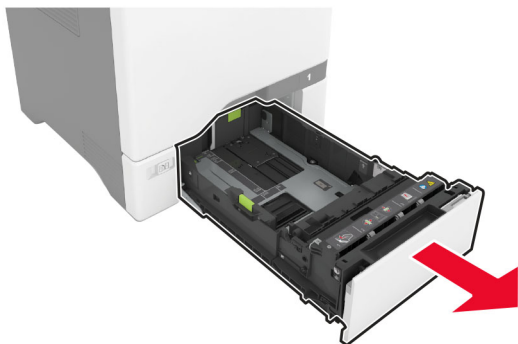

2 Remove the used separator bracket.

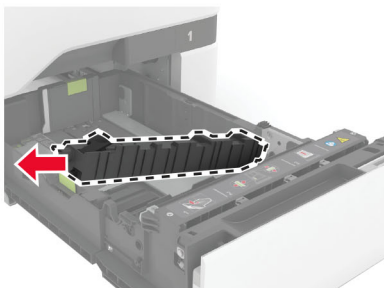
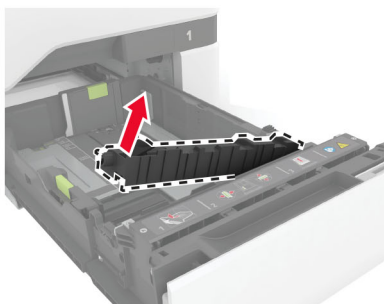
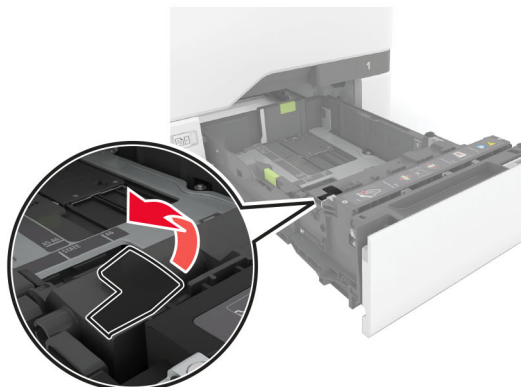

3 Unpack the new separator bracket.

4 Insert the new separator bracket.

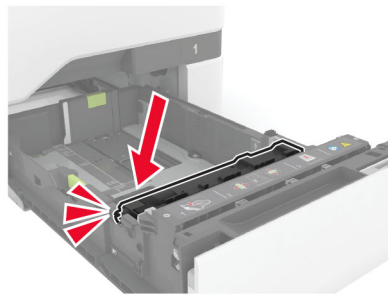
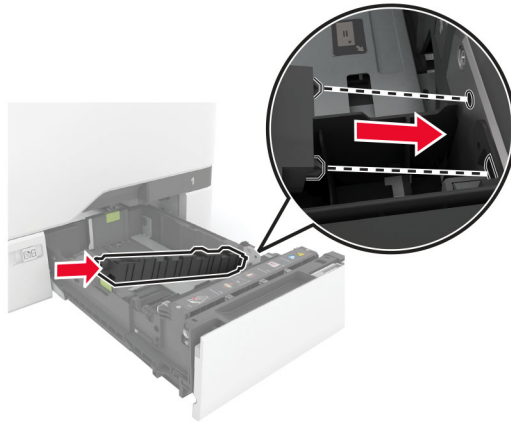

5 Insert the tray.

Replacing the scanner glass pad

1 Open the scanner cover.



- 2 Remove the used scanner glass pad.

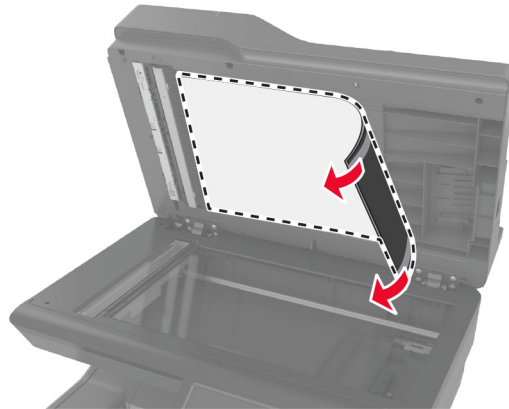

- 3 Unpack the new scanner glass pad.

- 4 Place the white area of the new scanner glass pad facedown on the scanner glass, and then remove the backing on the tape.

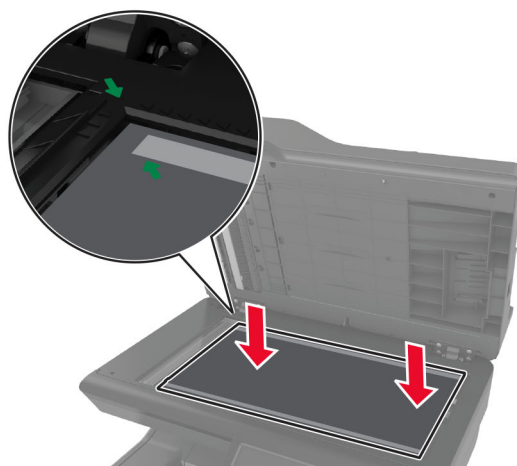

Note: Make sure that the scanner glass pad is aligned correctly on the edges of the scanner glass.

- 5 Close the scanner cover to stick the new scanner glass pad to the cover.

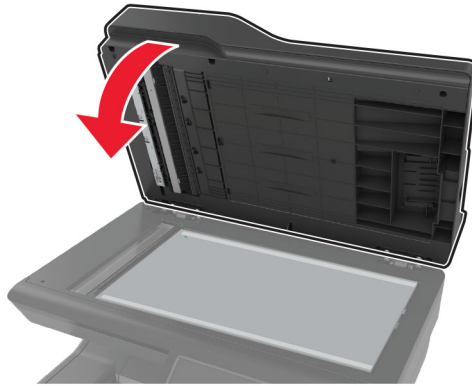

- 6 Open the scanner cover to check if the new scanner glass pad is properly attached to the cover.

- 7 Close the scanner cover.

Replacing the ADF rollers

- 1 Open door C.

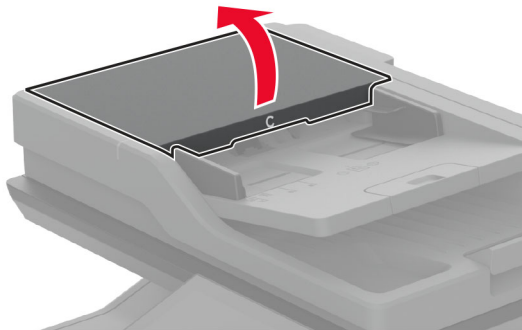

2 Remove the used ADF pick roller.

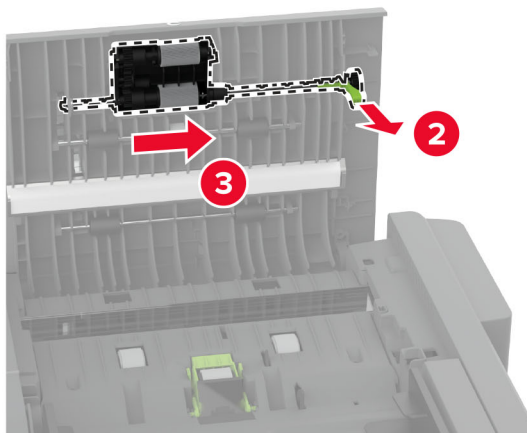
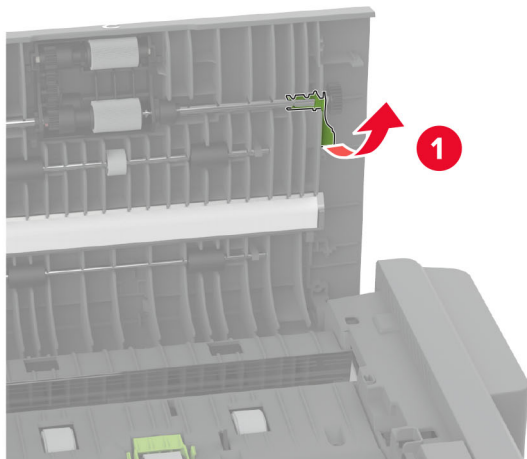

3 Remove the used ADF separator roller.

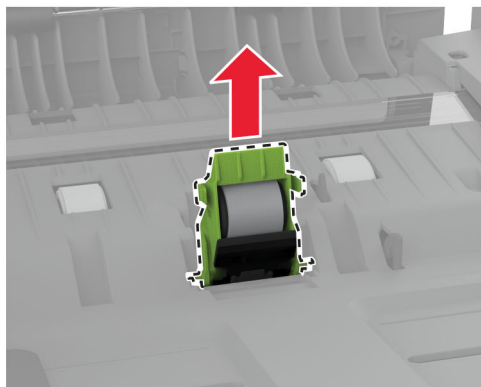
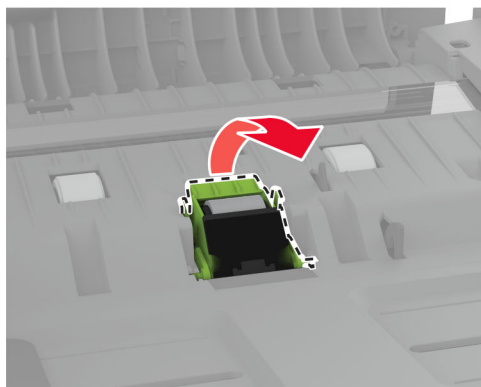
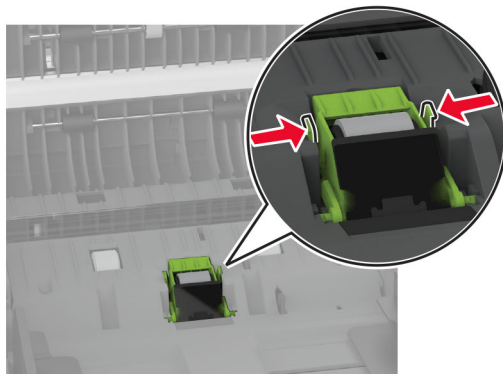

4 Unpack the new ADF pick roller and ADF separator roller.

5 Insert the new ADF separator roller until it *clicks* into place.

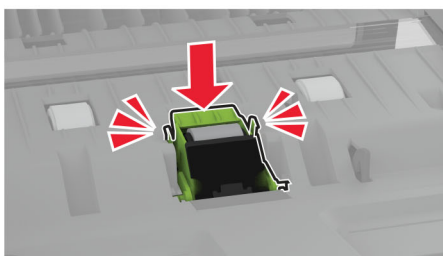
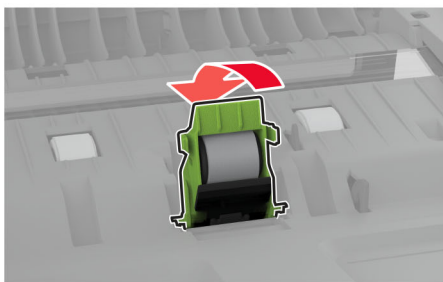
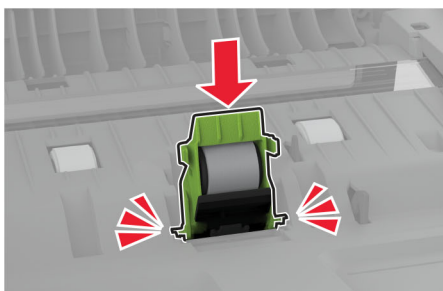
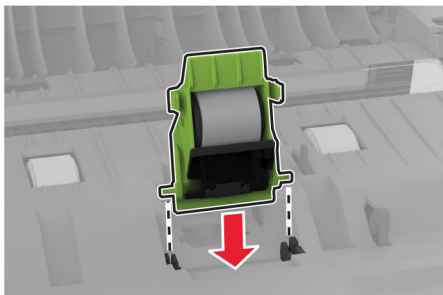

6 Insert the new ADF pick roller until it *clicks* into place.

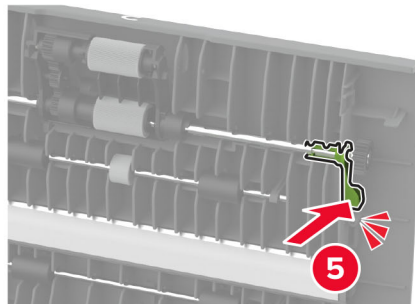
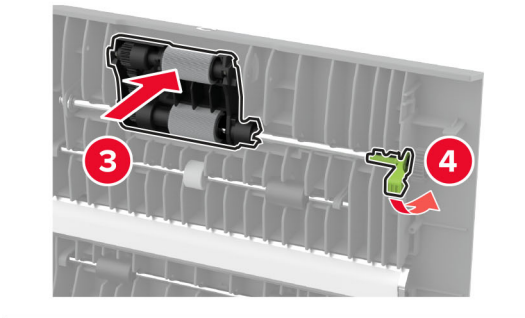
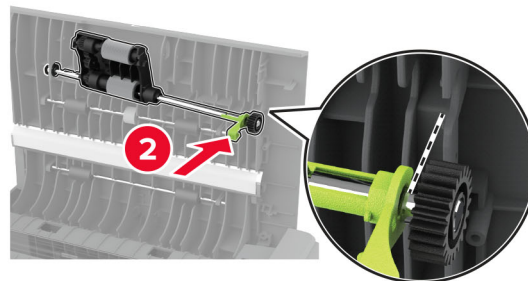
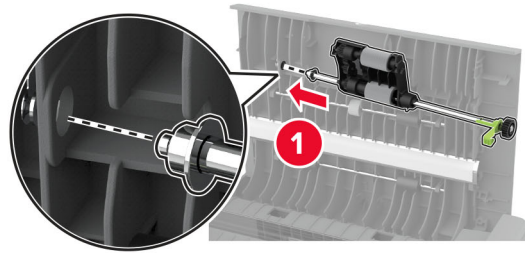

7 Close door C.

Resetting the maintenance counter

- 1 From the home screen, touch **Settings** > **Device** > **Maintenance** > **Configuration Menu** > **Supply Usage And Counters**.
- 2 Touch **Reset Maintenance Counter**.

Resetting the supply usage counters

- 1 From the home screen, touch **Settings > Device > Maintenance > Configuration Menu > Supply Usage And Counters**.
- 2 Select the counter that you want to reset.

Warning—Potential Damage: Supplies and parts without Return Program agreement terms may be reset and remanufactured. However, the manufacturer's warranty does not cover any damage caused by non-genuine supplies or parts. Resetting counters on the supply or part without proper remanufacturing can cause damage to your printer. After resetting the supply or part counter, your printer may display an error indicating the presence of the reset item.

Cleaning printer parts

Cleaning the printer

 **CAUTION—SHOCK HAZARD:** To avoid the risk of electrical shock when cleaning the exterior of the printer, unplug the power cord from the electrical outlet and disconnect all cables from the printer before proceeding.

Notes:

- Perform this task after every few months.
- Damage to the printer caused by improper handling is not covered by the printer warranty.

- 1 Turn off the printer, and then unplug the power cord from the electrical outlet.
- 2 Remove paper from the standard bin and multipurpose feeder.
- 3 Remove any dust, lint, and pieces of paper around the printer using a soft brush or vacuum.
- 4 Wipe the outside of the printer with a damp, soft, lint-free cloth.

Notes:

- Do not use household cleaners or detergents, as they may damage the finish of the printer.
- Make sure that all areas of the printer are dry after cleaning.

- 5 Connect the power cord to the electrical outlet, and then turn on the printer.

 **CAUTION—POTENTIAL INJURY:** To avoid the risk of fire or electrical shock, connect the power cord to an appropriately rated and properly grounded electrical outlet that is near the product and easily accessible.

Cleaning the touch screen

 **CAUTION—SHOCK HAZARD:** To avoid the risk of electric shock when cleaning the exterior of the printer, unplug the power cord from the electrical outlet and disconnect all cables from the printer before proceeding.

- 1 Turn off the printer, and then unplug the power cord from the electrical outlet.
- 2 Using a damp, soft, lint-free cloth, wipe the touch screen.

Notes:

- Do not use household cleaners or detergents, as they may damage the touch screen.
- Make sure that the touch screen is dry after cleaning.

3 Connect the power cord to the electrical outlet, and then turn on the printer.

⚠ CAUTION—POTENTIAL INJURY: To avoid the risk of fire or electrical shock, connect the power cord to an appropriately rated and properly grounded electrical outlet that is near the product and easily accessible.

Cleaning the scanner

1 Open the scanner cover.



2 Using a damp, soft, lint-free cloth, wipe the following areas:

- ADF glass pad



- Scanner glass pad

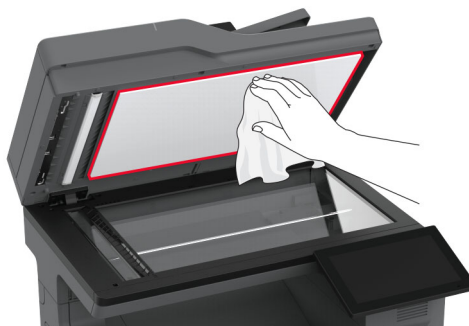

- ADF glass



- Scanner glass



- 3** Close the scanner cover.
- 4** Open door C.
- 5** Using a damp, soft, lint-free cloth, wipe the following areas:
 - ADF glass pad in door C

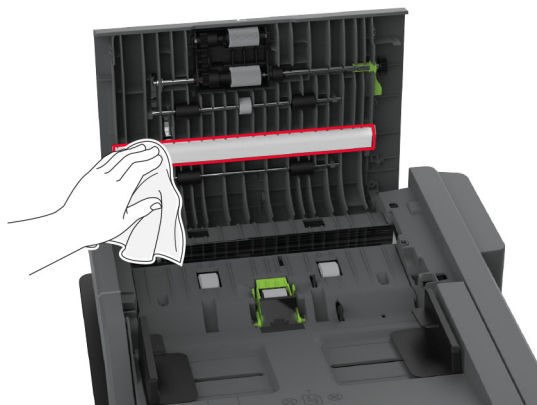

- ADF glass in door C



6 Close door C.

Cleaning the pick tires

- 1 Turn off the printer, and then unplug the power cord from the electrical outlet.
- 2 Remove the tray.

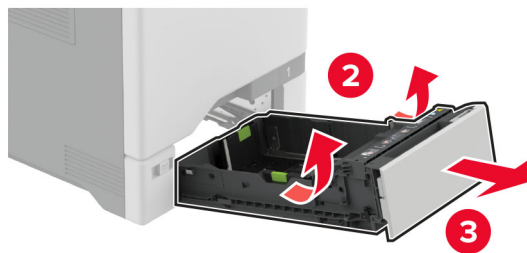

3 Remove the pick roller.

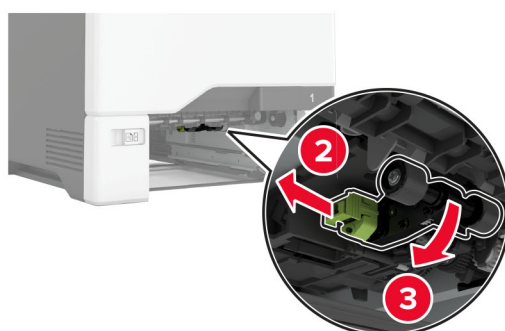

4 Apply isopropyl alcohol to a soft, lint-free cloth, and then wipe the pick tires.

- 5 Insert the pick roller.

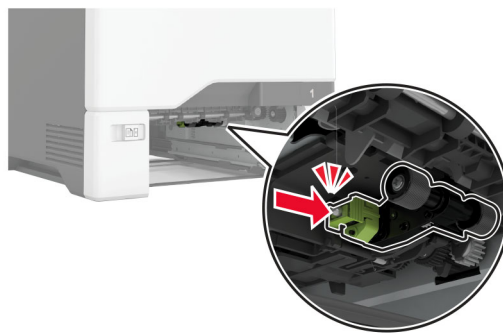

- 6 Insert the tray.

- 7 Connect the power cord to the electrical outlet, and then turn on the printer.

CAUTION—POTENTIAL INJURY: To avoid the risk of fire or electrical shock, connect the power cord to an appropriately rated and properly grounded electrical outlet that is near the product and easily accessible.

Cleaning the pick roller in the multipurpose feeder

- 1 Turn off the printer, and then unplug the power cord from the electrical outlet.
- 2 Open the multipurpose feeder.

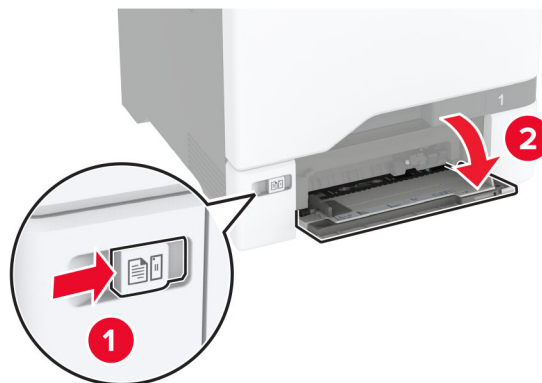

3 Remove the pick roller.

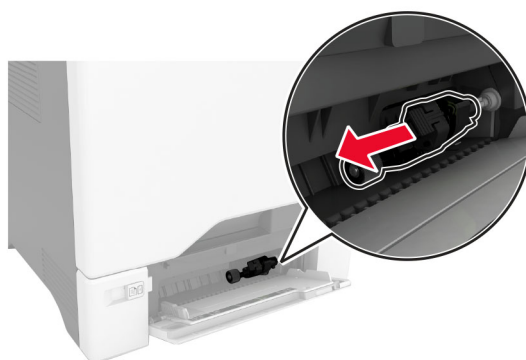

4 Apply isopropyl alcohol to a soft, lint-free cloth, and then wipe the pick roller.

- 5 Insert the pick roller.

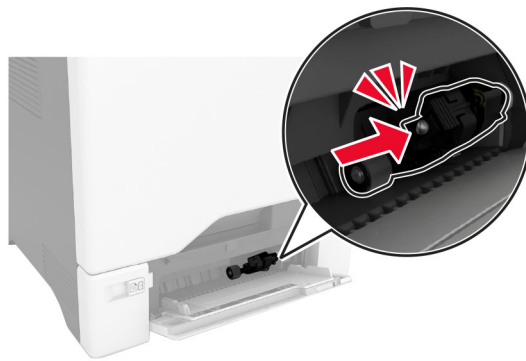
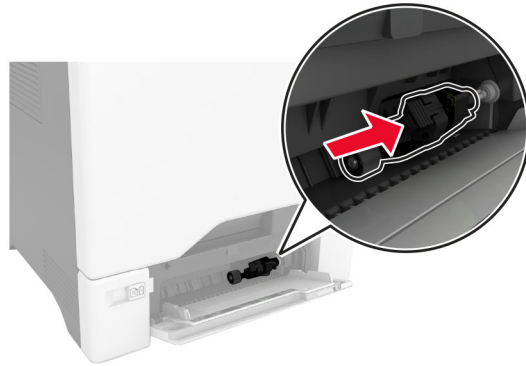

- 6 Close the multipurpose feeder.
- 7 Connect the power cord to the electrical outlet, and then turn on the printer.

⚠ CAUTION—POTENTIAL INJURY: To avoid the risk of fire or electrical shock, connect the power cord to an appropriately rated and properly grounded electrical outlet that is near the product and easily accessible.

Cleaning the ADF rollers

- 1 Open door C.

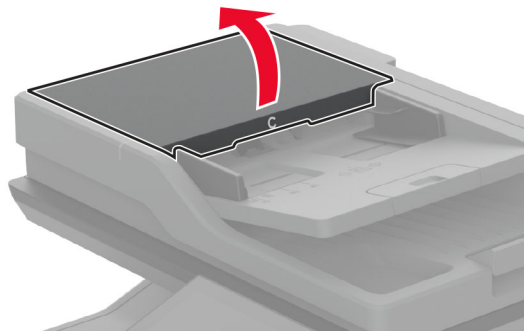

2 Remove the ADF pick roller.

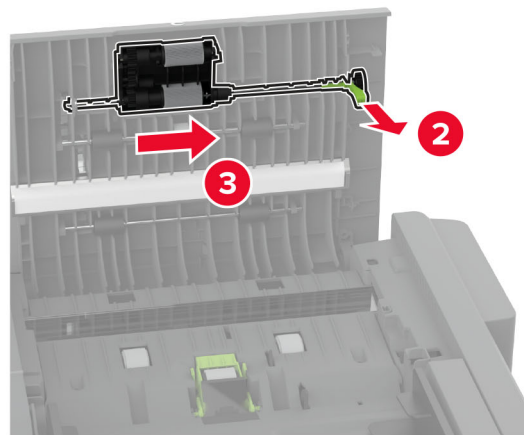
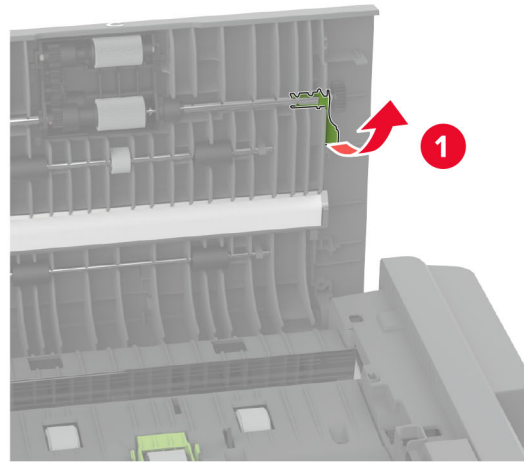

3 Remove the ADF separator roller.

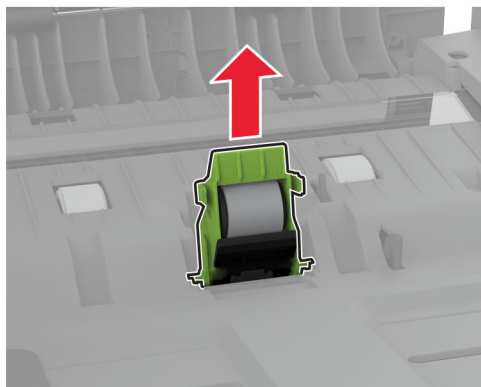
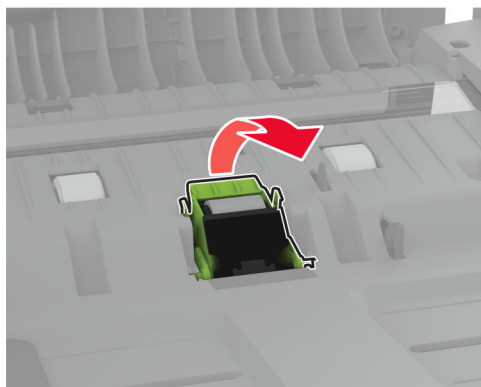
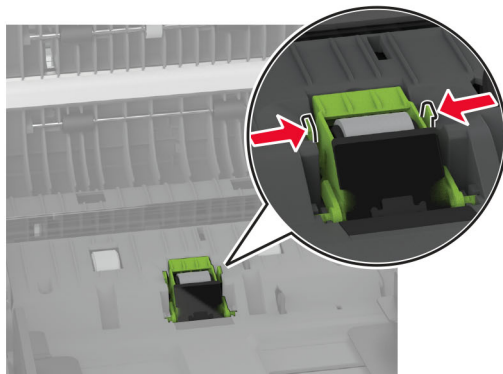

4 Apply isopropyl alcohol to a soft, lint-free cloth, and then wipe the ADF pick roller and ADF separator roller.

5 Insert the ADF separator roller until it *clicks* into place.

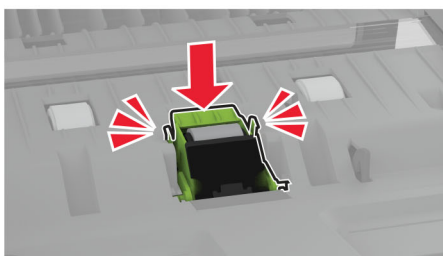
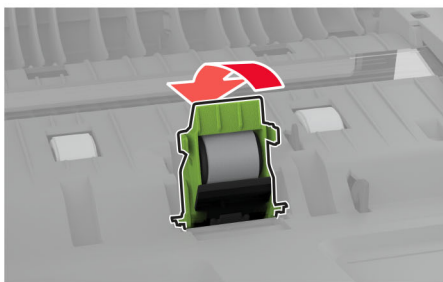
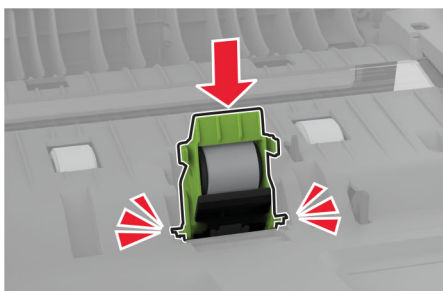
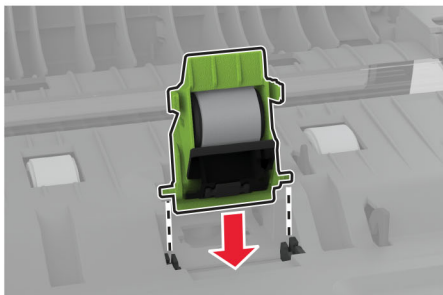

6 Insert the ADF pick roller until it *clicks* into place.

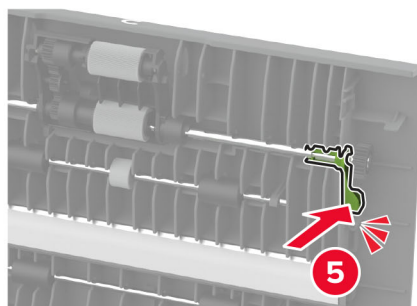
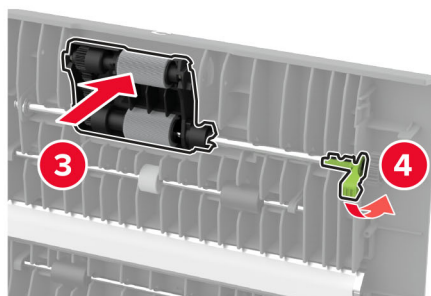
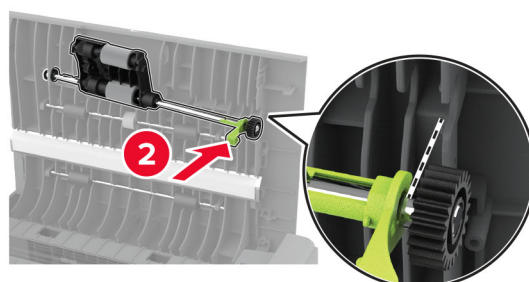
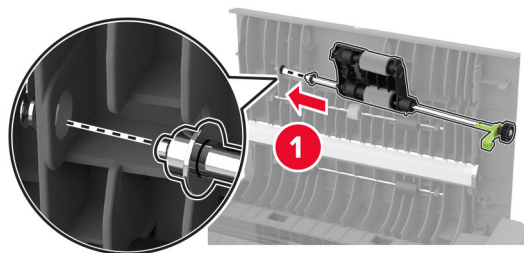

7 Close door C.

Saving energy and paper

Configuring the power save mode settings

Sleep mode

- 1 From the home screen, touch **Settings > Device > Power Management > Timeouts > Sleep Mode**.
- 2 Specify the amount of time that the printer stays idle before it enters Sleep Mode.

Hibernate mode

- 1 From the home screen, touch **Settings > Device > Power Management > Timeouts > Hibernate Timeout**.
- 2 Select the amount of time that the printer stays idle before it enters Hibernate mode.

Notes:

- For Hibernate Timeout to work, set Hibernate Timeout on Connection to Hibernate.
- The Embedded Web Server is disabled when the printer is in Hibernate mode.

Adjusting the brightness of the display

- 1 From the home screen, touch **Settings > Device > Preferences**.
- 2 In the Screen Brightness menu, adjust the setting.

Conserving supplies

- Print on both sides of the paper.
Note: Two-sided printing is the default setting in the print driver.
- Print multiple pages on a single sheet of paper.
- Use the preview feature to see how the document looks like before printing it.
- Print one copy of the document to check its content and format for accuracy.

Moving the printer to another location

Moving the printer to another location

 **CAUTION—POTENTIAL INJURY:** If the printer weight is greater than 20 kg (44 lb), then it may require two or more people to lift it safely.

 **CAUTION—POTENTIAL INJURY:** To avoid the risk of fire or electrical shock, use only the power cord provided with this product or the manufacturer's authorized replacement.

 **CAUTION—POTENTIAL INJURY:** When moving the printer, follow these guidelines to avoid personal injury or printer damage:

- Make sure that all doors and trays are closed.
- Turn off the printer, and then unplug the power cord from the electrical outlet.
- Disconnect all cords and cables from the printer.
- If the printer has separate floor-standing optional trays or output options attached to it, then disconnect them before moving the printer.
- If the printer has a caster base, then carefully roll it to the new location. Use caution when passing over thresholds and breaks in flooring.
- If the printer does not have a caster base but is configured with optional trays or output options, then remove the output options and lift the printer off the trays. Do not try to lift the printer and any options at the same time.
- Always use the handholds on the printer to lift it.
- Any cart used to move the printer must have a surface able to support the full footprint of the printer.
- Any cart used to move the hardware options must have a surface able to support the dimensions of the options.
- Keep the printer in an upright position.
- Avoid severe jarring movements.
- Make sure that your fingers are not under the printer when you set it down.
- Make sure that there is adequate clearance around the printer.

Note: Damage to the printer caused by improper moving is not covered by the printer warranty.

Shipping the printer

For shipping instructions, go to <http://support.lexmark.com> or contact customer support.

Troubleshoot a problem

Print quality problems

Find the image that resembles the print quality problem you are having, and then click the link below it to read problem-solving steps.

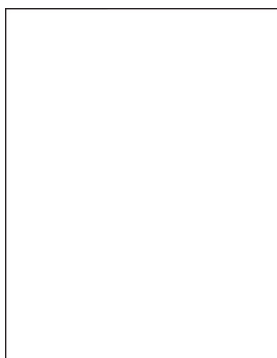

[“Blank or white pages” on page 273](#)

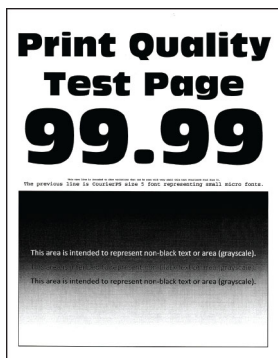

[“Dark print” on page 275](#)



[“Ghost images” on page 277](#)



[“Gray or colored background” on page 278](#)



[“Incorrect margins” on page 279](#)

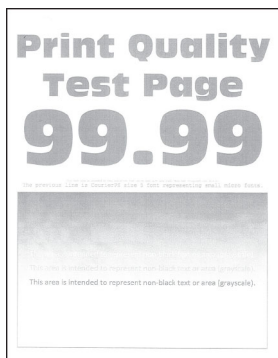

[“Light print” on page 279](#)

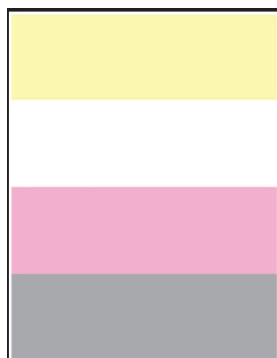

[“Missing colors” on page 282](#)

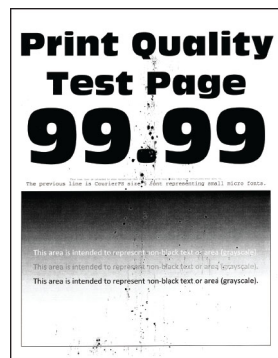

[“Mottled print and dots” on page 284](#)



[“Paper curl” on page 285](#)

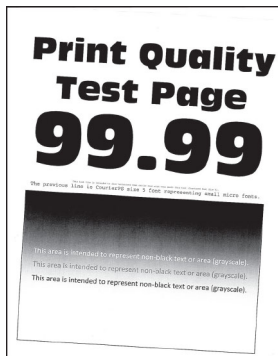

[“Print crooked or skewed” on page 286](#)



[“Solid color or black images” on page 287](#)

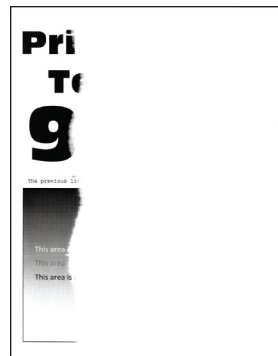

[“Text or images cut off” on page 288](#)

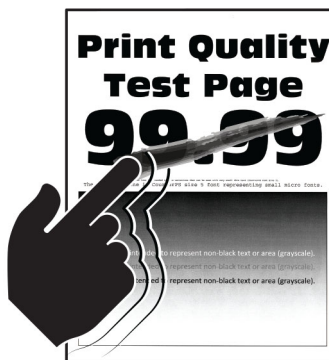

[“Toner easily rubs off” on page 290](#)

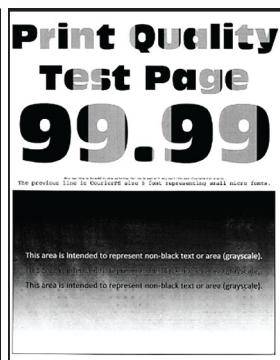

[“Uneven print density” on page 291](#)

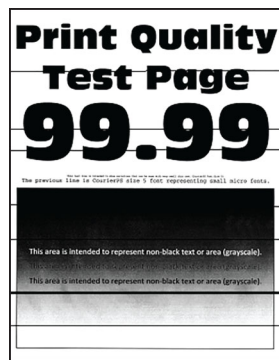

[“Horizontal dark lines” on page 292](#)



[“Vertical dark lines” on page 293](#)

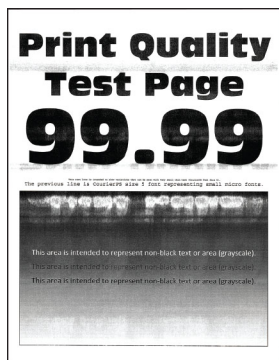

[“Horizontal white lines” on page 294](#)

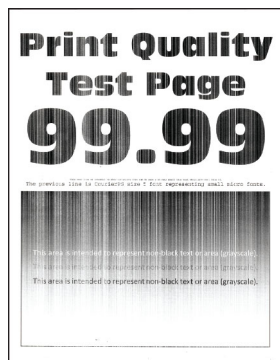

[“Vertical white lines” on page 295](#)



[“Repeating defects” on page 297](#)

Printer error codes



Error codes	Error message	Solution
8.01	Close all doors.	Close all doors, and then insert the waste toner bottle.
8.03	Close door C.	Keep all doors closed unless performing maintenance.
9.00	Printer had to restart. Last job may be incomplete.	Touch Continue to clear the message and continue printing.
11.11, 11.21, 11.31, 11.41, 11.51	Load <source/> with <type/> <size/>.	Open the indicated tray, and then load paper. For more information, see “Loading trays” on page 49.
11.12, 11.22, 11.32, 11.42, 11.52	Load <source/> with <type/> <size/> <orientation/>.	Open the indicated tray, and then load paper. For more information, see “Loading trays” on page 49.
11.91	Load multipurpose feeder with <type/> <size/>.	Open the multipurpose feeder, and then load paper. For more information, see “Loading the multipurpose feeder” on page 52.





Error codes	Error message	Solution
11.92	Load multipurpose feeder with <type/> <size/> <orientation/>.	Open the multipurpose feeder, and then load paper. For more information, see “Loading the multipurpose feeder” on page 52.
12.11, 12.21, 12.31, 12.41, 12.51	Change <source/> to <type/> <size/>.	Open the indicated tray, remove paper, and then load the correct paper type and size. For more information, see “Loading trays” on page 49.
12.12, 12.22, 12.32, 12.42, 12.52	Change <source/> to <type/> <size/> <orientation/>.	Open the indicated tray, remove paper, and then load the correct paper type and size. For more information, see “Loading trays” on page 49.
12.91	Change multipurpose feeder to <type/> <size/>.	Remove paper, and then load the correct paper type and size. For more information, see “Loading the multipurpose feeder” on page 52.
12.92	Change multipurpose feeder to <type/> <size/> <orientation/>.	Remove paper, and then load the correct paper type and size. For more information, see “Loading the multipurpose feeder” on page 52.
29.08	Reminder: Remove packaging.	<ol style="list-style-type: none"> 1 Open door A, and then remove the packing material inside the printer. 2 Pull out each of the three red clips starting with the upper left, lower left, and ending on the right side. 3 Close door A. 4 Open door B. 5 Pull the red loop on the right side straight out. 6 Close door B.
31.30	Transfer module problem. Restart printer.	<ol style="list-style-type: none"> 1 Turn off the printer, and then unplug the power cord from the electrical outlet. 2 Connect the power cord to the electrical outlet, and then turn on the printer. <p> CAUTION—POTENTIAL INJURY: To avoid the risk of fire or electrical shock, connect the power cord to an appropriately rated and properly grounded electrical outlet that is near the product and easily accessible.</p>

Error codes	Error message	Solution
31.35	Reinstall missing or unresponsive waste toner bottle.	<ol style="list-style-type: none"> 1 Open door B. 2 Remove the waste toner bottle. Note: To avoid spilling the toner, place the bottle in an upright position. 3 Insert the waste toner bottle. 4 Close door B.
31.40, 31.41, 31.42, 31.43	Reinstall missing or unresponsive [color] cartridge.	<ol style="list-style-type: none"> 1 Open door B. 2 Remove the cartridge. 3 Insert the cartridge. 4 Close door B.
31.60	Reinstall missing or unresponsive black imaging unit.	<ol style="list-style-type: none"> 1 Open door B. 2 Remove the waste toner bottle. Note: To avoid spilling the toner, place the bottle in an upright position. 3 Remove the toner cartridges. 4 Disconnect the imaging kit cable. 5 Remove the imaging kit. Note: To avoid scratching the imaging kit or damaging the photoconductor drum, place the imaging kit in an upright position. 6 Remove the black imaging unit. Warning—Potential Damage: Do not expose the photoconductor unit to direct light for more than 10 minutes. Extended exposure to light may cause print quality problems. Warning—Potential Damage: Do not touch the shiny photoconductor drum under the imaging unit. Doing so may affect the quality of future print jobs. 7 Insert the black imaging unit. 8 Insert the imaging kit. 9 Connect the imaging kit cable. 10 Insert the toner cartridges. 11 Insert the waste toner bottle. 12 Close door B.

Error codes	Error message	Solution
31.64	Reinstall missing, unplugged, or unresponsive color imaging kit.	<ol style="list-style-type: none"> 1 Open door B. 2 Remove the waste toner bottle. Note: To avoid spilling the toner, place the bottle in an upright position. 3 Remove the cartridges. 4 Disconnect the imaging kit cable. 5 Remove the imaging kit. 6 Insert the imaging kit. 7 Connect the imaging kit cable. 8 Insert the cartridges. 9 Insert the waste toner bottle. 10 Close door B.
31.80	Reinstall missing or unresponsive fuser.	<ol style="list-style-type: none"> 1 Open door A, and then open door A1.  CAUTION—HOT SURFACE: The inside of the printer might be hot. To reduce the risk of injury from a hot component, allow the surface to cool before touching it. 2 Remove the fuser. 3 Insert the fuser. 4 Close door A1, and then close door A.
32.40, 32.41, 32.42, 32.43	Replace unsupported [color] cartridge.	For more information, see “Replacing a toner cartridge” on page 211.
32.60	Replace unsupported black imaging unit.	For more information, see “Replacing the black imaging unit” on page 214.
32.64	Replace unsupported color imaging kit.	For more information, see “Replacing the color imaging kit” on page 223.

Error codes	Error message	Solution
32.xy	Replace unsupported fuser.	<p>1 Open door A, and then open door A1.</p> <p> CAUTION—HOT SURFACE: The inside of the printer might be hot. To reduce the risk of injury from a hot component, allow the surface to cool before touching it.</p> <p>2 Locate the fuser type at the bottom of the fuser.</p>  <p>Notes:</p> <ul style="list-style-type: none"> • All printer models except Lexmark CX737 support the fuser types 00, 01, and 02. • Lexmark CX737 only supports fuser type 05. <p>3 If the fuser is not supported, remove the fuser, and then install a supported one. For more information, see “Replacing the fuser” on page 234.</p>
33.40, 33.41, 33.42, 33.43	Non-Lexmark [color] cartridge, see <i>User's Guide</i>.	For more information, see “Non-Lexmark supply” on page 322 .
33.60	Non-Lexmark black imaging unit, see <i>User's Guide</i>.	For more information, see “Non-Lexmark supply” on page 322 .
33.64	Non-Lexmark color imaging kit, see <i>User's Guide</i>.	For more information, see “Non-Lexmark supply” on page 322 .
37.1	Insufficient memory to collate job.	<p>Try one or more of the following:</p> <ul style="list-style-type: none"> • Touch Continue to print the part of the job that is stored and to begin collating the rest of the print job. • Cancel the current print job.

Error codes	Error message	Solution
37.3	Insufficient memory, some held jobs were deleted.	Touch Continue to clear the message and continue printing.
39.1	Complex page, some data may not have printed.	Try one or more of the following: <ul style="list-style-type: none"> • Touch Continue to clear the message and continue printing. • Cancel the current print job. • Install more printer memory. • Reduce the complexity and size of the print job before sending it to print again. <ul style="list-style-type: none"> – Reduce the number of pages in the print job. – Reduce the number and size of any downloaded fonts. – Delete any unnecessary fonts or macros from the print job. – Reduce the number of graphics in the print job.
42.xy	Replace [color] cartridge, printer region mismatch.	For more information, see “Replace cartridge, printer region mismatch” on page 321.
43.40, 43.41, 43.42, 43.43	Replace defective [color] cartridge.	For more information, see “Replacing a toner cartridge” on page 211.
43.40, 43.41, 43.42, 43.43	[Color] cartridge problem.	<ol style="list-style-type: none"> 1 Open door B. 2 Remove the cartridge. 3 Insert the cartridge. 4 Close door B. If the problem persists, then replace the cartridge.
55.1	Error reading USB drive. Remove USB.	Remove the flash drive to continue.
55.2	Error reading USB hub. Remove hub.	Remove the USB hub to continue.

Error codes	Error message	Solution
58	Too many trays attached.	<ol style="list-style-type: none"> 1 Turn off the printer, and then unplug the power cord from the electrical outlet. 2 Remove one or more trays. 3 Connect the power cord to the electrical outlet, and then turn on the printer. <p> CAUTION—POTENTIAL INJURY: To avoid the risk of fire or electrical shock, connect the power cord to an appropriately rated and properly grounded electrical outlet that is near the product and easily accessible.</p>
59	Incompatible tray [x].	<ol style="list-style-type: none"> 1 Turn off the printer, and then unplug the power cord from the electrical outlet. 2 Remove the indicated tray. 3 Connect the power cord to the electrical outlet, and then turn on the printer. <p> CAUTION—POTENTIAL INJURY: To avoid the risk of fire or electrical shock, connect the power cord to an appropriately rated and properly grounded electrical outlet that is near the product and easily accessible.</p>
61	Defective disk.	Replace the defective storage drive.
62	Disk full.	<p>Try one or more of the following:</p> <ul style="list-style-type: none"> • Touch Continue to clear the message. • Delete fonts, macros, and other data stored in the printer hard disk. • Install a printer hard disk.
63	Format the disk.	<p>Formatting now wipes all information from the storage drive.</p> <p>To format the disk, do the following:</p> <ol style="list-style-type: none"> 1 From the home screen, touch Settings > Device > Maintenance > Out of Service Erase. 2 Touch Sanitize all information on hard disk, and then touch ERASE.



Error codes	Error message	Solution
71.01	Fax Station Name not set up. Contact system administrator.	For more information, see “Setting up the fax function using analog fax” on page 34.
71.02	Fax Station Number not set up. Contact system administrator.	
71.03	No analog phone line connected to modem, fax is disabled.	Check the connection and the line for a signal. For more information, see “Setting up fax using a standard telephone line” on page 36.
71.06	Unable to connect to HTTPS Fax Server.	Connection to HTTPS Fax Server is disconnected. Check the Internet connection of the printer.
71.12	Memory full, cannot print faxes.	Touch Print All to print as many of the faxes as have been saved.
71.13	Memory full. Cannot send faxes.	Try one or more of the following: <ul style="list-style-type: none"> • Continue and try sending the fax again. • Scan the original document one page at a time, dial the fax number, and then scan the document.
72.01	E-mail SMTP server not set up. Contact system administrator.	Try either of the following: <ul style="list-style-type: none"> • Set up your email function. For more information, see “Configuring the e-mail SMTP settings” on page 40. • Disable the error message. For more information, see “Disabling the ‘SMTP server not set up’ error message” on page 325.
80.01, 80.09	Maintenance kit nearly low.	Touch Continue to clear the message.
80.11, 80.19	Maintenance kit low.	Touch Continue to clear the message.
80.21, 80.29	Maintenance kit very low.	Touch Continue to clear the message.
80.31	Replace maintenance kit, recommended life exceeded.	For more information, see “Ordering a fuser maintenance kit” on page 210.
82.00, 82.02, 82.09	Waste toner bottle nearly full.	Touch Continue to clear the message.
82.12, 82.13, 82.19, 82.20, 82.22, 82.23, 82.29	Waste toner bottle almost full.	Touch Continue to clear the message.

Error codes	Error message	Solution
82.30, 82.30, 82.33, 82.39, 82.40, 82.42, 82.49	Replace waste toner bottle.	For more information, see “Replacing the waste toner bottle” on page 232.
84.01, 84.09	Black imaging unit or color imaging kit nearly low.	Touch Continue to clear the message.
84.11, 84.13, 84.19	Black imaging unit or color imaging kit low.	Touch Continue to clear the message.
84.21, 84.23, 84.29	Black imaging unit or color imaging kit very low.	Touch Continue to clear the message.
84.31, 84.33, 84.41, 84.43, 84.48	Replace black imaging unit or color imaging kit.	<ul style="list-style-type: none"> • For more information, see “Replacing the black imaging unit” on page 214. • For more information, see “Replacing the color imaging kit” on page 223.
88.00, 88.08, 88.09	[Color] cartridge nearly low.	Touch Continue to clear the message.
88.10, 88.18, 88.19	[Color] cartridge low.	
88.20, 88.28, 88.29	[Color] cartridge very low.	
88.30, 88.37, 88.38, 88.40, 88.47, 88.48	Replace the [color] cartridge.	For more information, see “Replacing a toner cartridge” on page 211.
200.23, 200.33, 200.43, 200.53, 232.23, 232.33, 232.43, 232.53, 240.23, 240.33, 240.43, 240.53, 242.33, 242.35, 242.43, 242.45, 242.53, 242.55, 243.43, 243.45, 243.53, 243.55, 244.53, 244.54, 244.55, 245.56, 662.23, 663.33, 664.43, 665.53	Paper jam, [jam header]. [xxx.yy]	For more information, see “Paper jam in trays” on page 309.
200.03, 240.05, 240.06, 240.82, 240.83, 240.84, 647.82, 647.83, 647.84, 647.85, 648.82, 648.83, 648.84, 648.85, 649.82, 649.83, 649.84, 649.85, 650.82, 650.83, 650.84, 650.85, 660.81, 660.82, 660.83, 660.84, 660.85, 660.86	Paper jam, [jam header]. [xxx.yy]	For more information, see “Paper jam in the multipurpose feeder” on page 310.
230.03, 230.13, 230.23, 230.33, 230.43, 230.53	Paper jam, [jam header]. [xxx.yy]	For more information, see “Paper jam in the standard bin” on page 311.
280.11, 280.13, 280.15, 280.91, 280.93, 280.95, 281.11, 281.15, 281.16, 281.91, 281.95, 281.96, 284.11, 284.13, 284.15, 284.91, 284.93, 284.95, 288.10, 288.90, 295.01, 680.10, 680.20, 680.40	Scanner jam. [xxx.yy]	For more information, see “Paper jam in the automatic document feeder” on page 310.

Printing problems

Print quality is poor

Blank or white pages

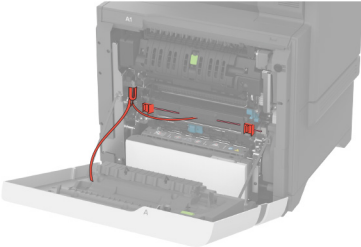
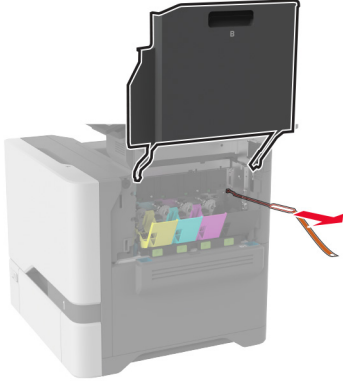
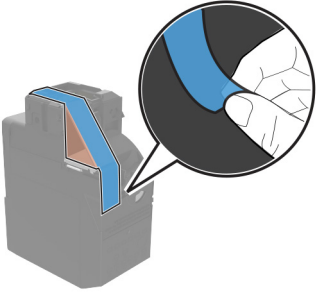
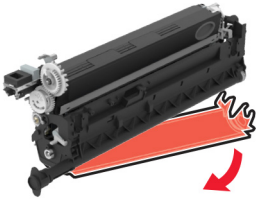

Note: Before solving the problem, print the Print Quality Test Pages. From the home screen, touch **Settings** > **Troubleshooting** > **Print Quality Test Pages**.

Action	Yes	No
<p>Step 1</p> <p>a Make sure to remove all the packing material in the following areas:</p> <ul style="list-style-type: none"> • Inside the printer   <ul style="list-style-type: none"> • Toner cartridges and imaging unit   <p>b Print the document.</p> <p>Is the printer printing blank or white pages?</p>	<p>Go to step 2.</p>	<p>The problem is solved.</p>

Action	Yes	No
<p>Step 2</p> <p>a Check if the printer is using a genuine and supported Lexmark toner cartridge.</p> <p>Note: If the cartridge is not supported, then install a supported one.</p> <p>b Print the document.</p> <p>Is the printer printing blank or white pages?</p>	Go to step 3.	The problem is solved.
<p>Step 3</p> <p>a Remove the color imaging kit, and then remove the black imaging unit.</p> <p>Warning—Potential Damage: Do not expose the color imaging kit and black imaging unit to direct light for more than 10 minutes. Extended exposure to light may cause print quality problems.</p> <p>Warning—Potential Damage: Do not touch the photoconductor drum under the color imaging kit and black imaging unit. Doing so may affect the quality of future print jobs.</p> <p>b Insert the black imaging unit, and then insert the color imaging kit.</p> <p>c Print the document.</p> <p>Is the printer printing blank or white pages?</p>	Contact customer support .	The problem is solved.

Dark print



Note: Before solving the problem, print the quality sample pages to determine the missing color. From the home screen, touch **Settings > Troubleshooting > Print Quality Test Pages**.

Action	Yes	No
<p>Step 1</p> <p>a Perform Color Adjust.</p> <p>From the home screen, touch Settings > Print > Quality > Advanced Imaging > Color Adjust.</p> <p>b Print the document.</p> <p>Is the print too dark?</p>	Go to step 2.	The problem is solved.

Action	Yes	No
<p>Step 2</p> <p>a Depending on your operating system, reduce the toner darkness from the Printing Preferences or Print dialog.</p> <p>Note: You can also change the settings on the printer control panel. From the home screen, touch Settings > Print > Quality > Toner Darkness.</p> <p>b Print the document.</p> <p>Is the print too dark?</p>	Go to step 3.	The problem is solved.
<p>Step 3</p> <p>a Depending on your operating system, specify the paper type from the Printing Preferences or Print dialog.</p> <p>Notes:</p> <ul style="list-style-type: none"> • Make sure that the settings match the paper loaded in the tray. • You can also change the settings on the printer control panel. From the home screen, touch Settings > Paper > Tray Configuration > Paper Size/Type. <p>b Print the document.</p> <p>Is the print too dark?</p>	Go to step 4.	Go to step 6.
<p>Step 4</p> <p>Make sure that the paper has no texture or rough finishes.</p> <p>Are you printing on textured or rough paper?</p>	Go to step 5.	Go to step 6.
<p>Step 5</p> <p>a Replace textured or rough paper with plain paper.</p> <p>b Print the document.</p> <p>Is the print too dark?</p>	Go to step 6.	The problem is solved.
<p>Step 6</p> <p>a Load paper from a fresh package.</p> <p>Note: Paper absorbs moisture due to high humidity. Store paper in its original wrapper until you are ready to use it.</p> <p>b Print the document.</p> <p>Is the print too dark?</p>	Contact customer support .	The problem is solved.

Ghost images



Note: Before solving the problem, print the Print Quality Test Pages. From the home screen, touch **Settings** > **Troubleshooting** > **Print Quality Test Pages**.

Action	Yes	No
<p>Step 1</p> <p>a Load the tray with the correct paper type and weight.</p> <p>b Print the document.</p> <p>Do ghost images appear on prints?</p>	Go to step 2.	The problem is solved.
<p>Step 2</p> <p>a Depending on your operating system, specify the paper type from the Printing Preferences or Print dialog.</p> <p>Notes:</p> <ul style="list-style-type: none"> • Make sure that the setting matches the paper loaded in the tray. • You can also change the setting on the printer control panel. From the home screen, touch Settings > Paper > Tray Configuration > Paper Size/Type. <p>b Print the document.</p> <p>Do ghost images appear on prints?</p>	Go to step 3.	The problem is solved.
<p>Step 3</p> <p>a Perform Color Adjust.</p> <p>From the home screen, touch Settings > Print > Quality > Advanced Imaging > Color Adjust.</p> <p>b Print the document.</p> <p>Do ghost images appear on prints?</p>	Contact customer support .	The problem is solved.

Gray or colored background



Note: Before solving the problem, print the Print Quality Test Pages. From the home screen, touch **Settings** > **Troubleshooting** > **Print Quality Test Pages**.

Action	Yes	No
<p>Step 1</p> <p>a Depending on your operating system, increase toner darkness from the Printing Preferences or Print dialog.</p> <p>Note: You can also change the setting on the printer control panel. From the home screen, touch Settings > Print > Quality > Toner Darkness.</p> <p>b Print the document.</p> <p>Does gray or colored background appear on prints?</p>	Go to step 2.	The problem is solved.
<p>Step 2</p> <p>a Perform Color Adjust.</p> <p>From the home screen, touch Settings > Print > Quality > Advanced Imaging > Color Adjust.</p> <p>b Print the document.</p> <p>Does gray or colored background appear on prints?</p>	Go to step 3.	The problem is solved.
<p>Step 3</p> <p>a Remove the color imaging kit, and then remove the black imaging unit.</p> <p>Warning—Potential Damage: Do not expose the color imaging kit and black imaging unit to direct light for more than 10 minutes. Extended exposure to light may cause print quality problems.</p> <p>Warning—Potential Damage: Do not touch the photoconductor drum under the color imaging kit and black imaging unit. Doing so may affect the quality of future print jobs.</p> <p>b Insert the black imaging unit, and then insert the color imaging kit.</p> <p>c Print the document.</p> <p>Does gray or colored background appear on prints?</p>	Contact customer support .	The problem is solved.



Incorrect margins



Action	Yes	No
<p>Step 1</p> <p>a Adjust the paper guides in the tray to the correct position for the paper loaded.</p> <p>b Print the document.</p> <p>Are the margins correct?</p>	<p>The problem is solved.</p>	<p>Go to step 2.</p>
<p>Step 2</p> <p>a Depending on your operating system, specify the paper size from the Printing Preferences or Print dialog.</p> <p>Notes:</p> <ul style="list-style-type: none"> • Make sure that the setting matches the paper loaded. • You can also change the setting on the printer control panel. From the home screen, touch Settings > Paper > Tray Configuration > Paper Size/Type. <p>Note:</p> <p>b Print the document.</p> <p>Are the margins correct?</p>	<p>The problem is solved.</p>	<p>Contact customer support.</p>

Light print

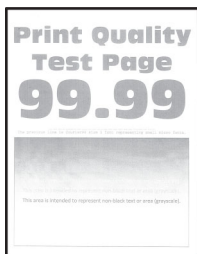

Note: Before solving the problem, print the Print Quality Test Pages. From the home screen, touch **Settings > Troubleshooting > Print Quality Test Pages**.

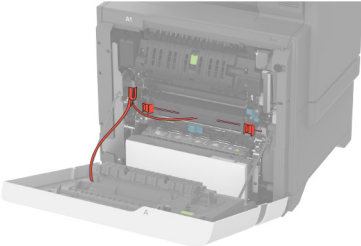
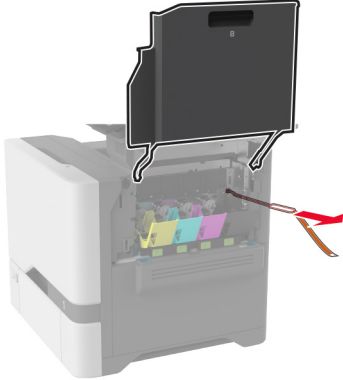
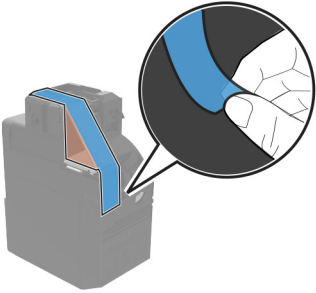
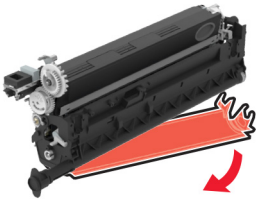
Action	Yes	No
<p>Step 1</p> <p>a Make sure to remove all the packing material in the following areas:</p> <ul style="list-style-type: none"> • Inside the printer  <hr/>  <ul style="list-style-type: none"> • Toner cartridges and imaging unit  <hr/>  <p>b Print the document.</p> <p>Is the print light?</p>	<p>Go to step 2.</p>	<p>The problem is solved.</p>

Action	Yes	No
<p>Step 2</p> <p>a Perform Color Adjust. From the home screen, touch Settings > Print > Quality > Advanced Imaging > Color Adjust.</p> <p>b Print the document.</p> <p>Is the print light?</p>	Go to step 3.	The problem is solved.
<p>Step 3</p> <p>a Depending on your operating system, increase toner darkness from the Printing Preferences or Print dialog. Note: You can also change the setting on the printer control panel. From the home screen, touch Settings > Print > Quality > Toner Darkness.</p> <p>b Print the document.</p> <p>Is the print light?</p>	Go to step 4.	The problem is solved.
<p>Step 4</p> <p>a Turn off Color Saver. From the home screen, touch Settings > Print > Quality > Color Saver.</p> <p>b Print the document.</p> <p>Is the print light?</p>	Go to step 5.	The problem is solved.
<p>Step 5</p> <p>a Depending on your operating system, specify the paper type from the Printing Preferences or Print dialog. Notes:</p> <ul style="list-style-type: none"> • Make sure that the setting matches the paper loaded. • You can also change the setting on the printer control panel. From the home screen, touch Settings > Paper > Tray Configuration > Paper Size/Type. <p>b Print the document.</p> <p>Is the print light?</p>	Go to step 6.	The problem is solved.
<p>Step 6</p> <p>Check if paper has texture or rough finishes.</p> <p>Are you printing on textured or rough paper?</p>	Go to step 7.	Go to step 7.
<p>Step 7</p> <p>a Replace textured or rough paper with plain paper.</p> <p>b Print the document.</p> <p>Is the print light?</p>	Go to step 8.	The problem is solved.

Action	Yes	No
<p>Step 8</p> <p>a Load paper from a fresh package.</p> <p>Note: Paper absorbs moisture due to high humidity. Store paper in its original wrapper until you are ready to use it.</p> <p>b Print the document.</p> <p>Is the print light?</p>	Go to step 9.	The problem is solved.
<p>Step 9</p> <p>a Remove the color imaging kit, and then remove the black imaging unit.</p> <p>Warning—Potential Damage: Do not expose the color imaging kit and black imaging unit to direct light for more than 10 minutes. Extended exposure to light may cause print quality problems.</p> <p>Warning—Potential Damage: Do not touch the photoconductor drum under the color imaging kit and black imaging unit. Doing so may affect the quality of future print jobs.</p> <p>b Insert the black imaging unit, and then insert the color imaging kit.</p> <p>c Print the document.</p> <p>Is the print too light?</p>	Contact customer support .	The problem is solved.

Missing colors

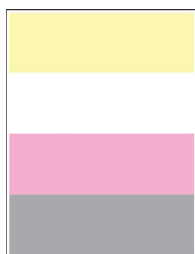

Note: Before solving the problem, print the Print Quality Test Pages. From the home screen, touch **Settings > Troubleshooting > Print Quality Test Pages**.

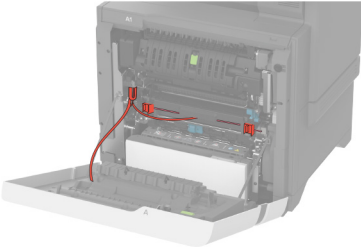
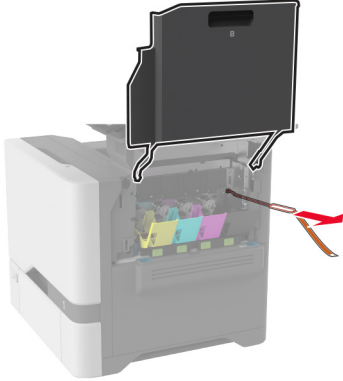
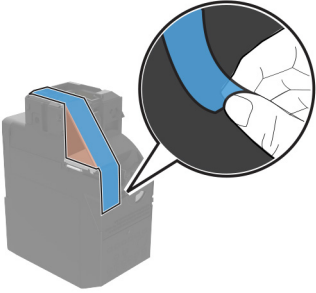
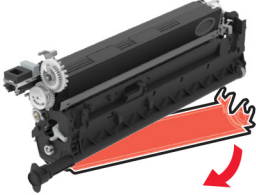
Action	Yes	No
<p>Step 1</p> <p>a Make sure to remove all the packing material in the following areas:</p> <ul style="list-style-type: none"> • Inside the printer  <hr/>  <ul style="list-style-type: none"> • Toner cartridges and imaging unit  <hr/>  <p>b Print the document.</p> <p>Are some colors missing on print?</p>	<p>Go to step 2.</p>	<p>The problem is solved.</p>

Action	Yes	No
<p>Step 2</p> <p>a Remove the color imaging kit.</p> <p>Warning—Potential Damage: Do not expose the color imaging kit to direct light for more than 10 minutes. Extended exposure to light may cause print quality problems.</p> <p>Warning—Potential Damage: Do not touch the photoconductor drum under the color imaging kit. Doing so may affect the quality of future print jobs.</p> <p>b Remove the toner cartridge of the missing color.</p> <p>c Remove, and then insert the developer unit of the missing color.</p> <p>d Insert the toner cartridge of the missing color.</p> <p>e Insert the color imaging kit.</p> <p>f Print the document.</p> <p>Are some colors missing on print?</p>	<p>Contact customer support.</p>	<p>The problem is solved.</p>

Mottled print and dots



Note: Before solving the problem, print the Print Quality Test Pages. From the home screen, touch **Settings** > **Troubleshooting** > **Print Quality Test Pages**.

Action	Yes	No
<p>Step 1</p> <p>Check the printer for leaked toner contamination.</p> <p>Is the printer free of leaked toner?</p>	<p>Go to step 2.</p>	<p>Contact customer support.</p>
<p>Step 2</p> <p>a From the home screen, touch Settings > Paper > Tray Configuration > Paper Size/Type.</p> <p>b Check if the paper size and paper type settings match the paper loaded.</p> <p>Note: Make sure that the paper does not have texture or rough finishes.</p> <p>Do the settings match?</p>	<p>Go to step 4.</p>	<p>Go to step 3.</p>

Action	Yes	No
<p>Step 3</p> <p>a Depending on your operating system, specify the paper size and paper type from the Printing Preferences or Print dialog.</p> <p>Notes:</p> <ul style="list-style-type: none"> • Make sure that the settings match the paper loaded in the tray. • You can also change the settings on the printer control panel. From the home screen, touch Settings > Paper > Tray Configuration > Paper Size/Type. <p>b Print the document.</p> <p>Is the print mottled?</p>	Go to step 4.	The problem is solved.
<p>Step 4</p> <p>a Load paper from a fresh package.</p> <p>Note: Paper absorbs moisture due to high humidity. Store paper in its original wrapper until you are ready to use it.</p> <p>b Print the document.</p> <p>Is the print mottled?</p>	Go to step 5.	The problem is solved.
<p>Step 5</p> <p>a Remove the color imaging kit, and then remove the black imaging unit.</p> <p>Warning—Potential Damage: Do not expose the color imaging kit and black imaging unit to direct light for more than 10 minutes. Extended exposure to light may cause print quality problems.</p> <p>Warning—Potential Damage: Do not touch the photoconductor drum under the color imaging kit and black imaging unit. Doing so may affect the quality of future print jobs.</p> <p>b Insert the black imaging unit, and then insert the color imaging kit.</p> <p>c Print the document.</p> <p>Is the print mottled?</p>	Contact customer support .	The problem is solved.

Paper curl



Action	Yes	No
<p>Step 1</p> <p>a Adjust the guides in the tray to the correct position for the paper loaded.</p> <p>b Print the document.</p> <p>Is the paper curled?</p>	Go to step 2.	The problem is solved.
<p>Step 2</p> <p>a Depending on your operating system, specify the paper type from the Printing Preferences or Print dialog.</p> <p>Notes:</p> <ul style="list-style-type: none"> • Make sure that the setting matches the paper loaded. • You can also change the setting on the printer control panel. From the home screen, touch Settings > Paper > Tray Configuration > Paper Size/Type. <p>b Print the document.</p> <p>Is the paper curled?</p>	Go to step 3.	The problem is solved.
<p>Step 3</p> <p>Print on the other side of the paper.</p> <p>a Remove paper, flip it over, and then reload paper.</p> <p>b Print the document.</p> <p>Is the paper curled?</p>	Go to step 4.	The problem is solved.
<p>Step 4</p> <p>a Load paper from a fresh package.</p> <p>Note: Paper absorbs moisture due to high humidity. Store paper in its original wrapper until you are ready to use it.</p> <p>b Print the document.</p> <p>Is the paper curled?</p>	Contact customer support .	The problem is solved.

Print crooked or skewed



Note: Before solving the problem, print the Print Quality Test Pages. From the home screen, touch **Settings** > **Troubleshooting** > **Print Quality Test Pages**.

Action	Yes	No
<p>Step 1</p> <ul style="list-style-type: none"> a Pull out the tray. b Remove the paper, and then load paper from a fresh package. Note: Paper absorbs moisture due to high humidity. Store paper in its original wrapper until you are ready to use it. c Adjust the paper guides in the tray to the correct position for the paper loaded. d Insert the tray. e Print the document. <p>Is the print crooked or skewed?</p>	Go to step 2.	The problem is solved.
<p>Step 2</p> <ul style="list-style-type: none"> a Make sure that you are printing on a supported paper. b Print the document. <p>Is the print crooked or skewed?</p>	Contact customer support .	The problem is solved.

Solid color or black images

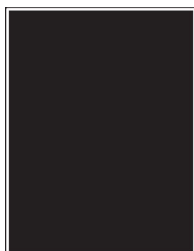

Note: Before solving the problem, print the Print Quality Test Pages. From the home screen, touch **Settings** > **Troubleshooting** > **Print Quality Test Pages**.

Action	Yes	No
<p>a Remove the color imaging kit, and then remove the black imaging unit.</p> <p>Warning—Potential Damage: Do not expose the color imaging kit and black imaging unit to direct light for more than 10 minutes. Extended exposure to light may cause print quality problems.</p> <p>Warning—Potential Damage: Do not touch the photoconductor drum under the color imaging kit and black imaging unit. Doing so may affect the quality of future print jobs.</p> <p>b Insert the black imaging unit, and then insert the color imaging kit.</p> <p>c Print the document.</p> <p>Is the printer printing solid color or black images?</p>	<p>Contact customer support.</p>	<p>The problem is solved.</p>

Text or images cut off

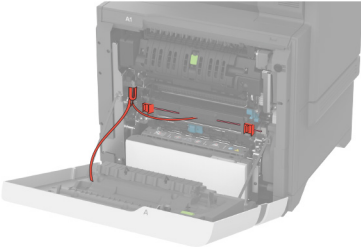
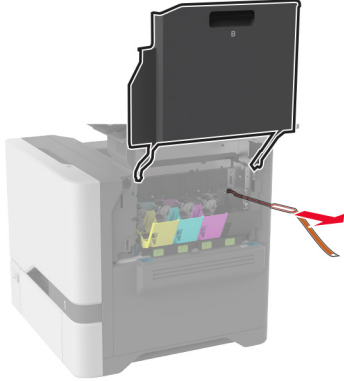
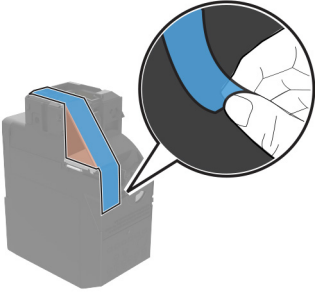
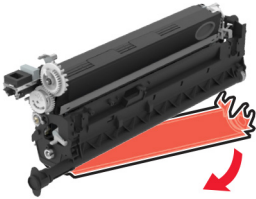

Note: Before solving the problem, print the Print Quality Test Pages. From the home screen, touch **Settings** > **Troubleshooting** > **Print Quality Test Pages**.

Action	Yes	No
<p>Step 1</p> <p>a Make sure to remove all the packing material in the following areas:</p> <ul style="list-style-type: none"> • Inside the printer  <hr/>  <ul style="list-style-type: none"> • Toner cartridges and imaging unit  <hr/>  <p>b Print the document.</p> <p>Is the text or image clipped?</p>	<p>Go to step 2.</p>	<p>The problem is solved.</p>

Action	Yes	No
<p>Step 2</p> <p>a Adjust the paper guides in the tray to the correct position for the paper loaded.</p> <p>b Print the document.</p> <p>Is the text or image clipped?</p>	Go to step 3.	The problem is solved.
<p>Step 3</p> <p>a Depending on your operating system, specify the paper size from the Printing Preferences or Print dialog.</p> <p>Notes:</p> <ul style="list-style-type: none"> • Make sure that the setting matches the paper loaded in the tray. • You can also change the setting on the printer control panel. From the home screen, touch Settings > Paper > Tray Configuration > Paper Size/Type. <p>b Print the document.</p> <p>Is the text or image clipped?</p>	Go to step 4.	The problem is solved.
<p>Step 4</p> <p>a Remove the color imaging kit, and then remove the black imaging unit.</p> <p>Warning—Potential Damage: Do not expose the color imaging kit and black imaging unit to direct light for more than 10 minutes. Extended exposure to light may cause print quality problems.</p> <p>Warning—Potential Damage: Do not touch the photoconductor drum under the color imaging kit and black imaging unit. Doing so may affect the quality of future print jobs.</p> <p>b Insert the black imaging unit, and then insert the color imaging kit.</p> <p>c Print the document.</p> <p>Is the text or image clipped?</p>	Contact customer support .	The problem is solved.

Toner easily rubs off

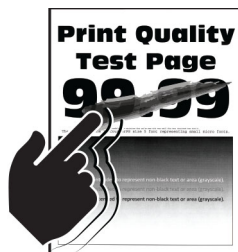

Note: Before solving the problem, print the Print Quality Test Pages. From the home screen, touch **Settings > Troubleshooting > Print Quality Test Pages**.

Action	Yes	No
<p>1 Depending on your operating system, specify the paper type from the Printing Preferences or Print dialog.</p> <p>Notes:</p> <ul style="list-style-type: none"> • Make sure that the setting matches the paper loaded. • You can also change the setting on the printer control panel. From the home screen, touch Settings > Paper > Tray Configuration > Paper Size/Type. <p>2 Print the document.</p> <p>Does the toner rub off?</p>	<p>Contact customer support.</p>	<p>The problem is solved.</p>

Uneven print density

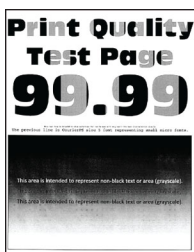

Note: Before solving the problem, print the Print Quality Test Pages. From the home screen, touch **Settings > Troubleshooting > Print Quality Test Pages**.

Action	Yes	No
<p>a Remove the color imaging kit, and then remove the black imaging unit.</p> <p>Warning—Potential Damage: Do not expose the color imaging kit and black imaging unit to direct light for more than 10 minutes. Extended exposure to light may cause print quality problems.</p> <p>Warning—Potential Damage: Do not touch the photoconductor drum under the color imaging kit and black imaging unit. Doing so may affect the quality of future print jobs.</p> <p>b Insert the black imaging unit, and then insert the color imaging kit.</p> <p>c Print the document.</p> <p>Is the print density uneven?</p>	<p>Contact customer support.</p>	<p>The problem is solved.</p>

Horizontal dark lines



Notes:

- Before solving the problem, print the Print Quality Test Pages. From the home screen, touch **Settings** > **Troubleshooting** > **Print Quality Test Pages**.
- If horizontal dark lines keep appearing on the prints, then see the “Repeating defects” topic.

Action	Yes	No
<p>Step 1</p> <p>a Depending on your operating system, specify the paper type from the Printing Preferences or Print dialog.</p> <p>Notes:</p> <ul style="list-style-type: none"> • Make sure that the setting matches the paper loaded. • You can also change the setting on the printer control panel. From the home screen, touch Settings > Paper > Tray Configuration > Paper Size/Type. <p>b Print the document.</p> <p>Do horizontal dark lines appear on prints?</p>	Go to step 2.	The problem is solved.
<p>Step 2</p> <p>a Load paper from a fresh package.</p> <p>Note: Paper absorbs moisture due to high humidity. Store paper in its original wrapper until you use it.</p> <p>b Print the document.</p> <p>Do horizontal dark lines appear on prints?</p>	Go to step 3.	The problem is solved.

Action	Yes	No
<p>Step 3</p> <p>a Remove the color imaging kit, and then remove the black imaging unit.</p> <p>Warning—Potential Damage: Do not expose the color imaging kit and black imaging unit to direct light for more than 10 minutes. Extended exposure to light may cause print quality problems.</p> <p>Warning—Potential Damage: Do not touch the photoconductor drum under the imaging kit and black imaging unit. Doing so may affect the quality of future print jobs.</p> <p>b Insert the black imaging unit, and then insert the color imaging kit.</p> <p>c Print the document.</p> <p>Do horizontal dark lines appear on prints?</p>	<p>Contact customer support.</p>	<p>The problem is solved.</p>

Vertical dark lines

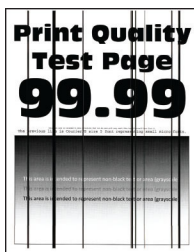

Note: Before solving the problem, print the Print Quality Test Pages. From the home screen, touch **Settings > Troubleshooting > Print Quality Test Pages**.

Action	Yes	No
<p>Step 1</p> <p>a Depending on your operating system, specify the paper type from the Printing Preferences or Print dialog.</p> <p>Notes:</p> <ul style="list-style-type: none"> • Make sure that the setting matches the paper loaded in the tray. • You can also change the setting on the printer control panel. From the home screen, touch Settings > Paper > Tray Configuration > Paper Size/Type. <p>b Print the document.</p> <p>Do vertical dark lines appear on prints?</p>	<p>Go to step 2.</p>	<p>The problem is solved.</p>

Action	Yes	No
<p>Step 2</p> <p>a Load paper from a fresh package.</p> <p>Note: Paper absorbs moisture due to high humidity. Store paper in its original wrapper until you use it.</p> <p>b Print the document.</p> <p>Do vertical dark lines appear on prints?</p>	Go to step 3.	The problem is solved.
<p>Step 3</p> <p>a Remove the color imaging kit, and then remove the black imaging unit.</p> <p>Warning—Potential Damage: Do not expose the color imaging kit and black imaging unit to direct light for more than 10 minutes. Extended exposure to light may cause print quality problems.</p> <p>Warning—Potential Damage: Do not touch the photoconductor drum under the color imaging kit and black imaging unit. Doing so may affect the quality of future print jobs.</p> <p>b Insert the black imaging unit, and then insert the color imaging kit.</p> <p>c Print the document.</p> <p>Do vertical dark lines appear on prints?</p>	Contact customer support .	The problem is solved.

Horizontal white lines



Notes:

- Before solving the problem, print the Print Quality Test Pages. From the home screen, touch **Settings** > **Troubleshooting** > **Print Quality Test Pages**.
- If horizontal white lines keep appearing on the prints, then see the “Repeating defects” topic.

Action	Yes	No
<p>Step 1</p> <p>a Depending on your operating system, specify the paper type from the Printing Preferences or Print dialog.</p> <p>Notes:</p> <ul style="list-style-type: none"> • Make sure that the setting matches the paper loaded in the tray. • You can also change the setting on the printer control panel. From the home screen, touch Settings > Paper > Tray Configuration > Paper Size/Type. <p>b Print the document.</p> <p>Do horizontal white lines appear on prints?</p>	Go to step 2.	The problem is solved.
<p>Step 2</p> <p>a Load the specified paper source with the recommended paper type.</p> <p>b Print the document.</p> <p>Do horizontal white lines appear on prints?</p>	Go to step 3.	The problem is solved.
<p>Step 3</p> <p>a Remove the color imaging kit, and then remove the black imaging unit.</p> <p>Warning—Potential Damage: Do not expose the color imaging kit and black imaging unit to direct light for more than 10 minutes. Extended exposure to light may cause print quality problems.</p> <p>Warning—Potential Damage: Do not touch the photoconductor drum under the color imaging kit and black imaging unit. Doing so may affect the quality of future print jobs.</p> <p>b Insert the black imaging unit, and then insert the color imaging kit.</p> <p>c Print the document.</p> <p>Do horizontal white lines appear on prints?</p>	Contact customer support .	The problem is solved.

Vertical white lines



Note: Before solving the problem, print the Print Quality Test Pages. From the home screen, touch **Settings** > **Troubleshooting** > **Print Quality Test Pages**.

Action	Yes	No
<p>Step 1</p> <p>a Depending on your operating system, specify the paper type from the Printing Preferences or Print dialog.</p> <p>Notes:</p> <ul style="list-style-type: none"> • Make sure that the setting matches the paper loaded in the tray. • You can also change the setting on the printer control panel. From the home screen, touch Settings > Paper > Tray Configuration > Paper Size/Type. <p>b Print the document.</p> <p>Do vertical white lines appear on prints?</p>	<p>Go to step 2.</p>	<p>The problem is solved.</p>
<p>Step 2</p> <p>Check if you are using the recommended paper type.</p> <p>a Load the specified paper source with the recommended paper type.</p> <p>b Print the document.</p> <p>Do vertical white lines appear on prints?</p>	<p>Go to step 3.</p>	<p>The problem is solved.</p>
<p>Step 3</p> <p>a Remove the color imaging kit, and then remove the black imaging unit.</p> <p>Warning—Potential Damage: Do not expose the color imaging kit and black imaging unit to direct light for more than 10 minutes. Extended exposure to light may cause print quality problems.</p> <p>Warning—Potential Damage: Do not touch the photoconductor drum under the color imaging kit and black imaging unit. Doing so may affect the quality of future print jobs.</p> <p>b Insert the black imaging unit, and then insert the color imaging kit.</p> <p>c Print the document.</p> <p>Do vertical white lines appear on prints?</p>	<p>Contact customer support.</p>	<p>The problem is solved.</p>



Repeating defects

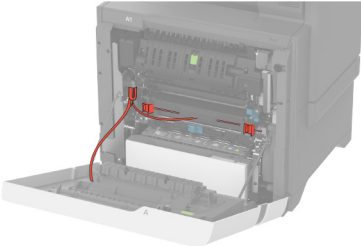
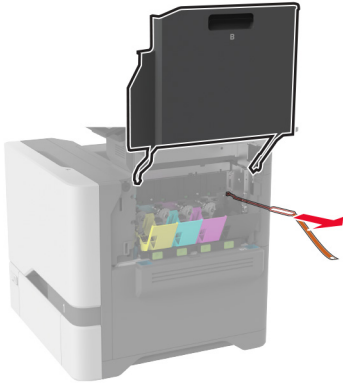
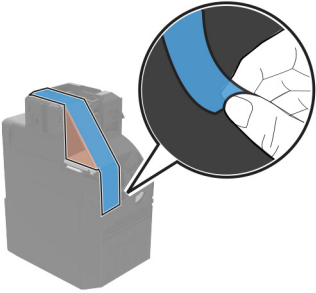
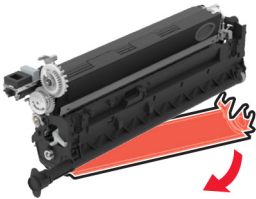

Note: Before solving the problem, print the quality sample pages to determine the cause of the repeating defects. From the home screen, touch **Settings** > **Troubleshooting** > **Print Quality Test Pages**.

Action	Yes	No
<p>Step 1</p> <p>a Make sure to remove all the packing material in the following areas:</p> <ul style="list-style-type: none"> • Inside the printer  <hr/>  <ul style="list-style-type: none"> • Toner cartridges and imaging unit  <hr/>  <p>b Print the document.</p> <p>Do the defects still appear?</p>	<p>Go to step 2.</p>	<p>The problem is solved.</p>

Action	Yes	No
<p>Step 2 Determine how many colors have defects.</p> <p>Is only one color affected?</p>	<p>Go to step 3.</p>	<p>Go to step 3.</p>
<p>Step 3</p> <p>a Using the Maintenance Defect Ruler, measure the distance between the repeating defects on the affected color page.</p> <p>b Replace the supply item that matches the measurement on the affected color page.</p> <p>Color imaging kit or black imaging unit</p> <ul style="list-style-type: none"> • 94.5 mm (3.72 in.) • 29.9 mm (1.18 in.) • 23.2 mm (0.91 in.) <p>Developer unit</p> <ul style="list-style-type: none"> • 43.6 mm (1.72 in.) • 45.0 mm (1.77 in.) <p>c Print the Print Quality Test Pages.</p> <p>Do the defects still appear?</p>	<p>Take note of the distance, and then contact customer support or your service representative.</p>	<p>The problem is solved.</p>
<p>Step 4</p> <p>a Using the Maintenance Defect Ruler, measure the distance between the repeating defects on the affected color page.</p> <p>b Replace the supply item that matches the measurement on the affected color page.</p> <p>Transfer module</p> <ul style="list-style-type: none"> • 37.7 mm (1.48 in.) • 78.5 mm (3.09 in.) • 54.6 mm (2.15 in.) <p>Fuser</p> <ul style="list-style-type: none"> • 95 mm (3.74 in.) • 110 mm (4.33 in.) <p>c Print the Print Quality Test Pages.</p> <p>Do the defects still appear?</p>	<p>Take note of the distance, and then contact customer support or your service representative.</p>	<p>The problem is solved.</p>

Print jobs do not print

Action	Yes	No
<p>Step 1</p> <p>a From the document you are trying to print, open the Print dialog, and then check if you have selected the correct printer.</p> <p>b Print the document.</p> <p>Is the document printed?</p>	The problem is solved.	Go to step 2.
<p>Step 2</p> <p>a Check if the printer is on.</p> <p>b Resolve any error messages that appear on the display.</p> <p>c Print the document.</p> <p>Is the document printed?</p>	The problem is solved.	Go to step 3.
<p>Step 3</p> <p>a Check if the ports are working and if the cables are securely connected to the computer and the printer. For more information, see the setup documentation that came with the printer.</p> <p>b Print the document.</p> <p>Is the document printed?</p>	The problem is solved.	Go to step 4.
<p>Step 4</p> <p>a Turn off the printer, wait for about 10 seconds, and then turn on the printer.</p> <p>b Print the document.</p> <p>Is the document printed?</p>	The problem is solved.	Go to step 5.
<p>Step 5</p> <p>a Remove, and then reinstall the print driver.</p> <p>b Print the document.</p> <p>Is the document printed?</p>	The problem is solved.	Contact customer support .

Confidential and other held documents do not print

Action	Yes	No
<p>Step 1</p> <p>a From the control panel, check if the documents appear in the Held Jobs list.</p> <p>Note: If the documents are not listed, then print the documents using the Print and Hold options.</p> <p>b Print the documents.</p> <p>Are the documents printed?</p>	<p>The problem is solved.</p>	<p>Go to step 2.</p>
<p>Step 2</p> <p>The print job may contain a formatting error or invalid data.</p> <ul style="list-style-type: none"> • Delete the print job, and then send it again. • For PDF files, generate a new file, and then print the documents. <p>Are the documents printed?</p>	<p>The problem is solved.</p>	<p>Go to step 3.</p>
<p>Step 3</p> <p>If you are printing from the Internet, then the printer may be reading the multiple job titles as duplicates.</p> <p>For Windows users</p> <p>a Open the Printing Preferences dialog.</p> <p>b From the Print and Hold tab, click Use Print and Hold, and then click Keep duplicate documents.</p> <p>c Enter a PIN, and then save the changes.</p> <p>d Send the print job.</p> <p>For Macintosh users</p> <p>a Save and name each job differently.</p> <p>b Send the job individually.</p> <p>Are the documents printed?</p>	<p>The problem is solved.</p>	<p>Go to step 4.</p>
<p>Step 4</p> <p>a Delete some held jobs to free up printer memory.</p> <p>b Print the documents.</p> <p>Are the documents printed?</p>	<p>The problem is solved.</p>	<p>Go to step 5.</p>
<p>Step 5</p> <p>a Add printer memory.</p> <p>b Print the documents.</p> <p>Are the documents printed?</p>	<p>The problem is solved.</p>	<p>Contact customer support.</p>

Job prints from the wrong tray or on the wrong paper

Action	Yes	No
<p>Step 1</p> <p>a Check if you are printing on the correct paper.</p> <p>b Print the document.</p> <p>Is the document printed on the correct paper?</p>	Go to step 2.	Load the correct paper size and paper type.
<p>Step 2</p> <p>a Depending on your operating system, specify the paper size and paper type from the Printing Preferences or Print dialog.</p> <p>Note: You can also change the settings on the printer control panel. From the home screen, touch Settings > Paper > Tray Configuration > Paper Size/Type.</p> <p>b Make sure that the settings match the paper loaded.</p> <p>c Print the document.</p> <p>Is the document printed on the correct paper?</p>	The problem is solved.	Go to step 3.
<p>Step 3</p> <p>a Check if the trays are linked.</p> <p>For more information, see “Linking trays” on page 54.</p> <p>b Print the document.</p> <p>Is the document printed from the correct tray?</p>	The problem is solved.	Contact customer support .

Slow printing

Action	Yes	No
<p>Step 1</p> <p>Make sure that the printer cable is securely connected to the printer and to the computer, print server, option, or other network device.</p> <p>Is the printer printing slow?</p>	Go to step 2.	The problem is solved.
<p>Step 2</p> <p>a Make sure that the printer is not in Quiet Mode.</p> <p>From the home screen, touch Settings > Device > Maintenance > Configuration Menu > Device Operations > Quiet Mode.</p> <p>b Print the document.</p> <p>Is the printer printing slow?</p>	Go to step 3.	The problem is solved.

Action	Yes	No
<p>Step 3</p> <p>a Depending on your operating system, specify the print resolution from the Printing Preferences or Print dialog.</p> <p>b Set the resolution to 4800 CQ.</p> <p>c Print the document.</p> <p>Is the printer printing slow?</p>	Go to step 4.	The problem is solved.
<p>Step 4</p> <p>a From the home screen, touch Settings > Print > Quality > Print Resolution.</p> <p>b Set the resolution to 4800 CQ.</p> <p>c Print the document.</p> <p>Is the printer printing slow?</p>	Go to step 5.	The problem is solved.
<p>Step 5</p> <p>a Depending on your operating system, specify the paper type from the Printing Preferences or Print dialog.</p> <p>Notes:</p> <ul style="list-style-type: none"> • Make sure that the setting matches the paper loaded. • You can also change the setting on the printer control panel. From the home screen, touch Settings > Paper > Tray Configuration > Paper Size/Type. • Heavier paper prints more slowly. • Paper narrower than letter, A4, and legal may print more slowly. <p>b Print the document.</p> <p>Is the printer printing slow?</p>	Go to step 6.	The problem is solved.
<p>Step 6</p> <p>a Make sure that the printer settings for texture and weight match the paper being loaded.</p> <p>From the home screen, touch Settings > Paper > Media Configuration > Media Types.</p> <p>Note: Rough paper texture and heavy paper weight may print more slowly.</p> <p>b Print the document.</p> <p>Is the printer printing slow?</p>	Go to step 7.	The problem is solved.
<p>Step 7</p> <p>Remove held jobs.</p> <p>Is the printer printing slow?</p>	Go to step 8.	The problem is solved.

Action	Yes	No
<p>Step 8</p> <p>a Make sure that the printer is not overheating.</p> <p>Notes:</p> <ul style="list-style-type: none"> • Allow the printer to cool down after a long print job. • Observe the recommended ambient temperature for the printer. For more information, see “Selecting a location for the printer” on page 20. <p>b Print the document.</p> <p>Is the printer printing slow?</p>	<p>Contact customer support.</p>	<p>The problem is solved.</p>

The printer is not responding

Action	Yes	No
<p>Step 1</p> <p>Check if the power cord is connected to the electrical outlet.</p> <p> CAUTION—POTENTIAL INJURY: To avoid the risk of fire or electrical shock, connect the power cord to an appropriately rated and properly grounded electrical outlet that is near the product and easily accessible.</p> <p>Is the printer responding?</p>	<p>The problem is solved.</p>	<p>Go to step 2.</p>
<p>Step 2</p> <p>Check if the electrical outlet is turned off by a switch or breaker.</p> <p>Is the electrical outlet turned off by a switch or breaker?</p>	<p>Turn on the switch or reset the breaker.</p>	<p>Go to step 3.</p>
<p>Step 3</p> <p>Check if the printer is on.</p> <p>Is the printer on?</p>	<p>Go to step 4.</p>	<p>Turn on the printer.</p>
<p>Step 4</p> <p>Check if the printer is in Sleep or Hibernate mode.</p> <p>Is the printer in Sleep or Hibernate mode?</p>	<p>Press the power button to wake the printer.</p>	<p>Go to step 5.</p>
<p>Step 5</p> <p>Check if the cables connecting the printer and the computer are inserted to the correct ports.</p> <p>Are the cables inserted to the correct ports?</p>	<p>Go to step 6.</p>	<p>Insert the cables to the correct ports.</p>

Action	Yes	No
<p>Step 6</p> <p>Turn off the printer, install the hardware options, and then turn on the printer.</p> <p>For more information, see the documentation that came with the option.</p> <p>Is the printer responding?</p>	The problem is solved.	Go to step 7.
<p>Step 7</p> <p>Install the correct print driver.</p> <p>Is the printer responding?</p>	The problem is solved.	Go to step 8.
<p>Step 8</p> <p>Turn off the printer, wait for about 10 seconds, and then turn on the printer.</p> <p>Is the printer responding?</p>	The problem is solved.	Contact customer support .

Unable to read flash drive

Action	Yes	No
<p>Step 1</p> <p>Check if the printer is not busy processing another print, copy, scan, or fax job.</p> <p>Is the printer ready?</p>	Go to step 3.	Go to step 2.
<p>Step 2</p> <ul style="list-style-type: none"> • Wait for the printer to finish processing the other job. • Remove, and then insert the flash drive. <p>Does the printer recognize the flash drive?</p>	The problem is solved.	Go to step 3.
<p>Step 3</p> <p>Check if the flash drive is inserted into the front USB port.</p> <p>Note: The flash drive does not work when it is inserted into the rear USB port.</p> <p>Is the flash drive inserted into the correct port?</p>	Go to step 5.	Go to step 4.
<p>Step 4</p> <p>Insert the flash drive into the correct port.</p> <p>Does the printer recognize the flash drive?</p>	The problem is solved.	Go to step 5.

Action	Yes	No
<p>Step 5 Check if the flash drive is supported. For more information, see “Supported flash drives and file types” on page 106.</p> <p>Is the flash drive supported?</p>	Go to step 7.	Go to step 6.
<p>Step 6 Insert a supported flash drive.</p> <p>Does the printer recognize the flash drive?</p>	The problem is solved.	Go to step 7.
<p>Step 7 Remove, and then insert the flash drive.</p> <p>Does the printer recognize the flash drive?</p>	The problem is solved.	Contact customer support.

Enabling the USB port

From the home screen, touch **Settings > Network/Ports > USB > Enable USB Port.**

Clearing jams

Avoiding jams

Load paper properly

- Make sure that the paper lies flat in the tray.

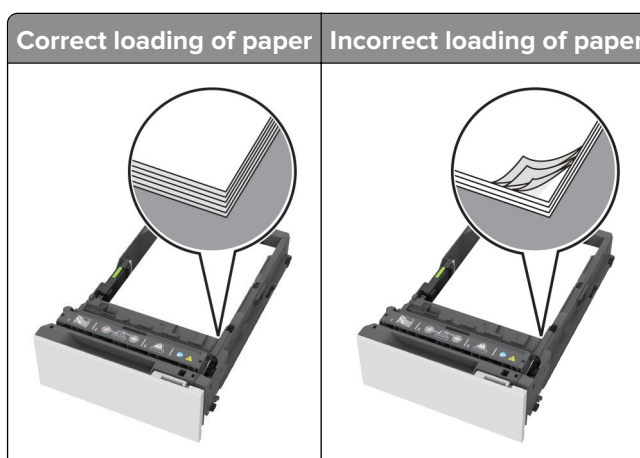

- Do not load or remove a tray while the printer is printing.
- Do not load too much paper. Make sure that the stack height is below the maximum paper fill indicator.

- Do not slide paper into the tray. Load paper as shown in the illustration.



- Make sure that the paper guides are positioned correctly and are not pressing tightly against the paper or envelopes.
- Push the tray firmly into the printer after loading paper.

Use recommended paper

- Use only recommended paper or specialty media.
- Do not load paper that is wrinkled, creased, damp, bent, or curled.
- Flex, fan, and align the paper edges before loading.

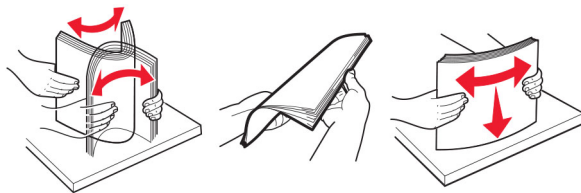

- Do not use paper that has been cut or trimmed by hand.
- Do not mix paper sizes, weights, or types in the same tray.
- Make sure that the paper size and type are set correctly on the computer or printer control panel.
- Store paper according to manufacturer recommendations.

Identifying jam locations

Notes:

- When Jam Assist is set to On, the printer flushes blank pages or pages with partial prints after a jammed page has been cleared. Check your printed output for blank pages.
- When Jam Recovery is set to On or Auto, the printer reprints jammed pages.

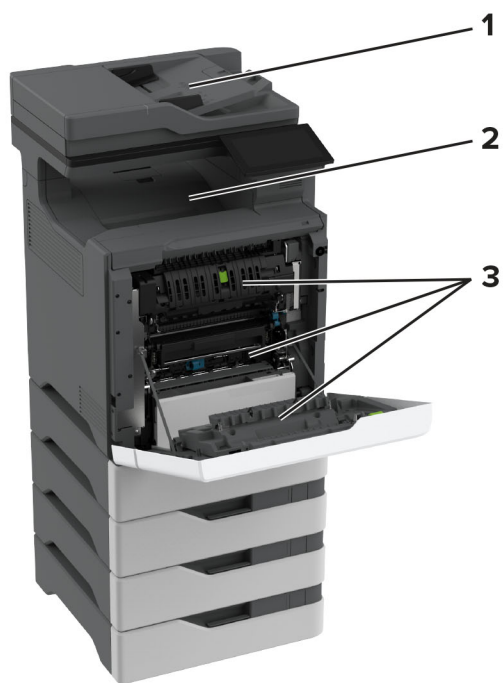

	Jam locations
1	ADF
2	Standard bin
3	Door A
4	Multipurpose feeder
5	Trays

Paper jam in trays

- 1 Remove the tray.

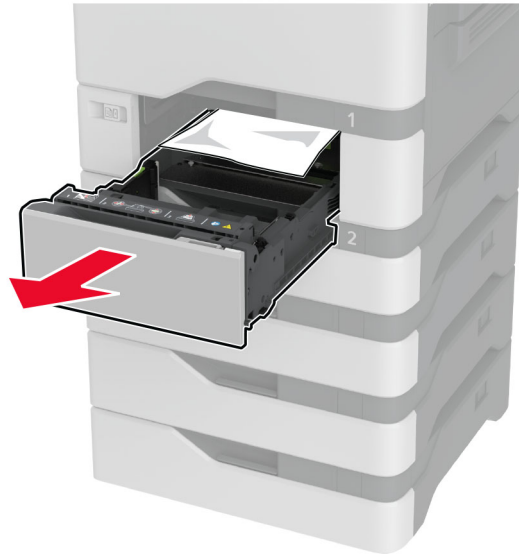

Warning—Potential Damage: A sensor inside the optional tray is easily damaged by static electricity. Touch a metal surface before removing the jammed paper in the tray.

- 2 Remove the jammed paper.

Note: Make sure that all paper fragments are removed.

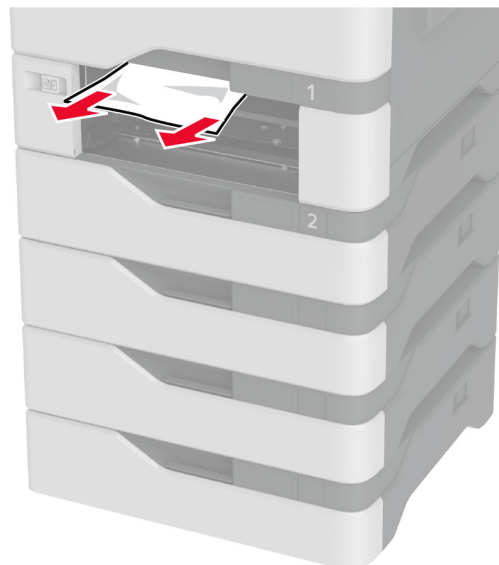

- 3 Insert the tray.

Paper jam in the automatic document feeder

- 1 Remove all original documents from the ADF tray.
- 2 Open door C.

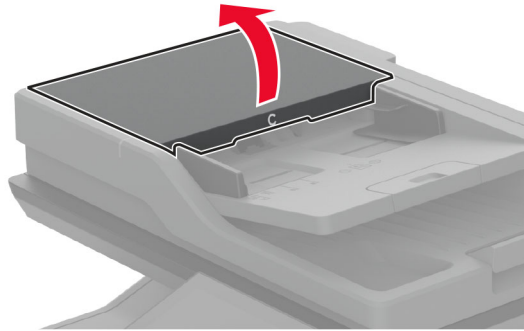

- 3 Remove the jammed paper.

Note: Make sure that all paper fragments are removed.

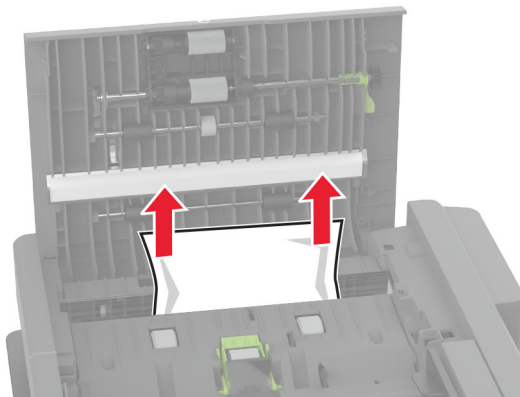

- 4 Close door C.

Paper jam in the multipurpose feeder

- 1 Remove paper from the multipurpose feeder.
- 2 Pull out the tray.
- 3 Remove the jammed paper.

Note: Make sure that all paper fragments are removed.

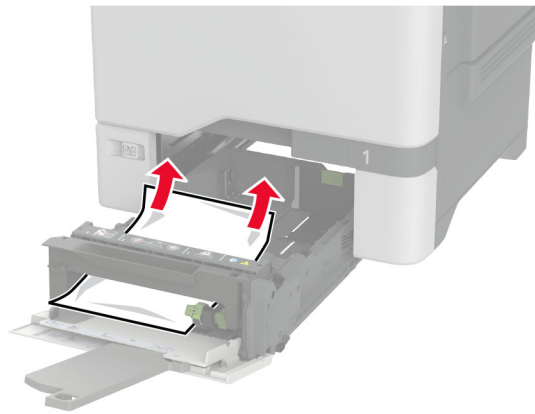

4 Insert the tray.

Paper jam in the standard bin

Remove the jammed paper.

Note: Make sure that all paper fragments are removed.



Paper jam in door A

Paper jam in the fuser area

1 Open door A.

 **CAUTION—HOT SURFACE:** The inside of the printer might be hot. To reduce the risk of injury from a hot component, allow the surface to cool before touching it.

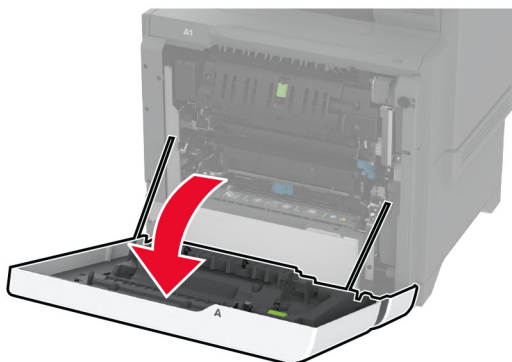

2 Remove the jammed paper.

Note: Make sure that all paper fragments are removed.

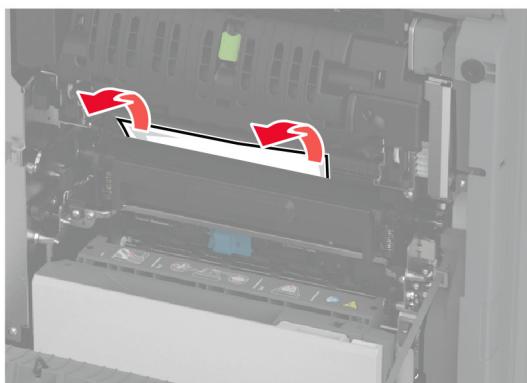

3 Open door A1.



- 4 Open the fuser access door.

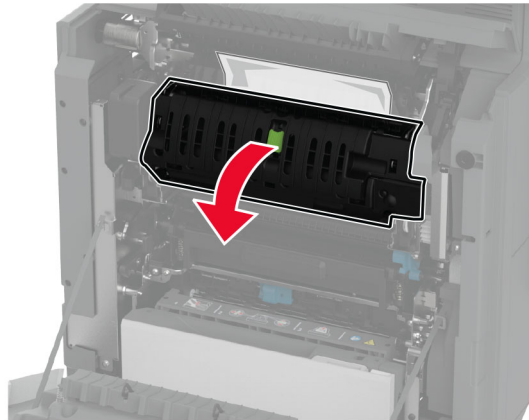

- 5 Remove the jammed paper.

Note: Make sure that all paper fragments are removed.

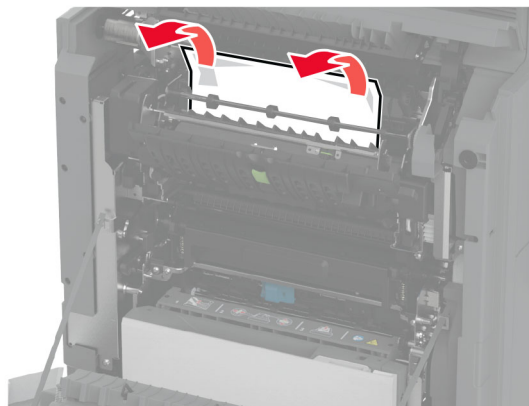

- 6 Close and latch the fuser access door.

- 7 Close door A1, and then close door A.

Paper jam behind door A

- 1 Open door A.

 **CAUTION—HOT SURFACE:** The inside of the printer might be hot. To reduce the risk of injury from a hot component, allow the surface to cool before touching it.

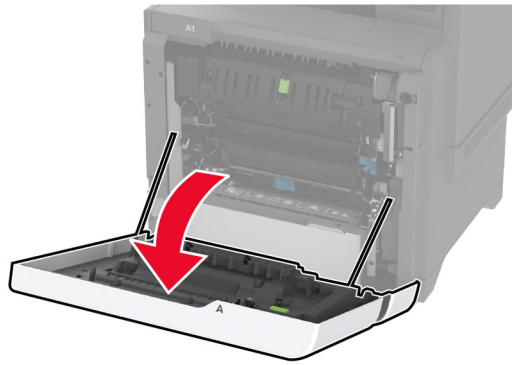

2 Open the isolation unit door.

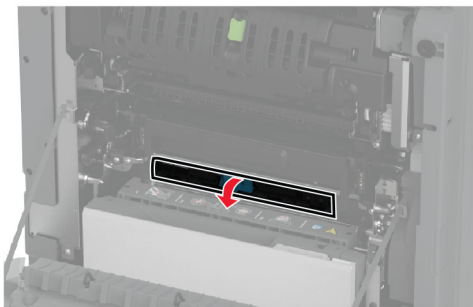
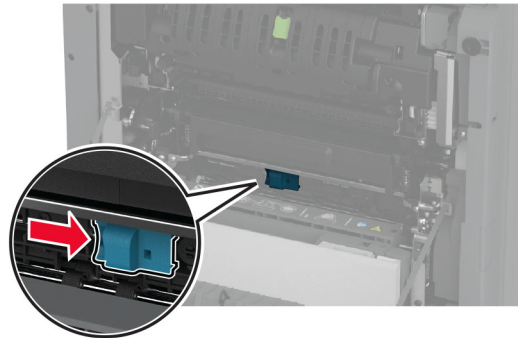

3 Remove the jammed paper.

Note: Make sure that all paper fragments are removed.

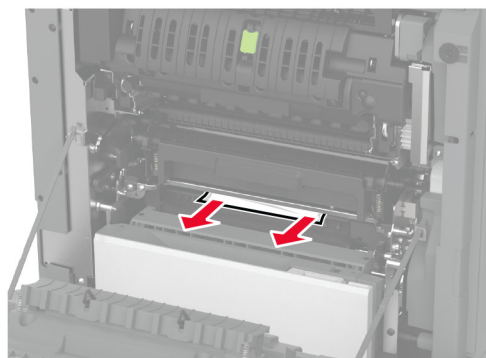

- 4 Close and latch the isolation unit door.
- 5 Close door A.

Paper jam in the duplex area

- 1 Open door A.

 **CAUTION—HOT SURFACE:** The inside of the printer might be hot. To reduce the risk of injury from a hot component, allow the surface to cool before touching it.

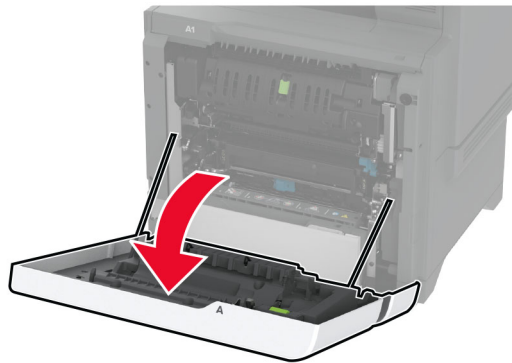

- 2 Open the duplex cover.

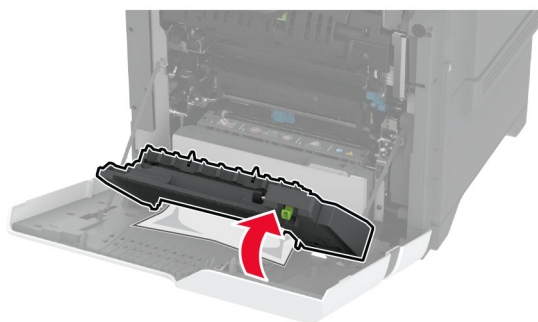
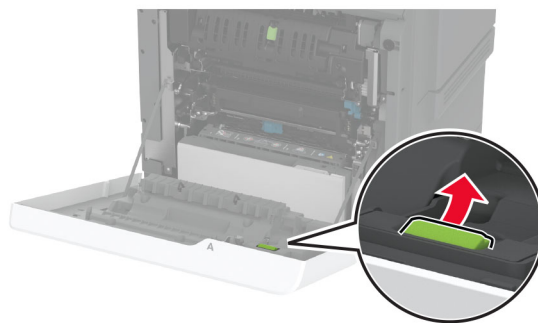

- 3 Remove the jammed paper.

Note: Make sure that all paper fragments are removed.

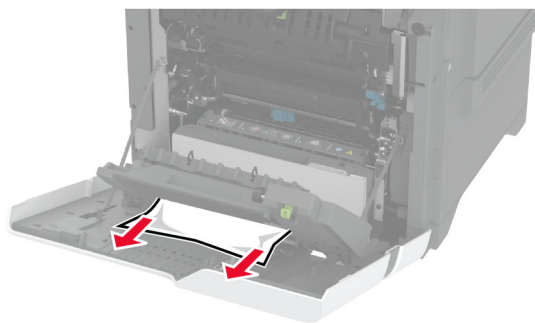

4 Close the duplex cover, and then close door A.

Network connection problems

Cannot open Embedded Web Server

Action	Yes	No
<p>Step 1</p> <p>a Check if the printer is on.</p> <p>b Access the printer Embedded Web Server (EWS).</p> <p>Can you open the EWS?</p>	The problem is solved.	Go to step 2.
<p>Step 2</p> <p>a Make sure that the printer IP address is correct.</p> <p>Notes:</p> <ul style="list-style-type: none"> • View the IP address on the home screen. • An IP address appears as four sets of numbers separated by periods, such as 123.123.123.123. <p>b Access the EWS.</p> <p>Can you open the EWS?</p>	The problem is solved.	Go to step 3.
<p>Step 3</p> <p>a Make sure that you installed a supported browser:</p> <ul style="list-style-type: none"> • Internet Explorer version 11 or later • Microsoft Edge • Safari version 6 or later • Google Chrome™ version 32 or later • Mozilla Firefox version 24 or later <p>b Access the EWS.</p> <p>Can you open the EWS?</p>	The problem is solved.	Go to step 4.

Action	Yes	No
<p>Step 4</p> <p>a Check if the network connection is working. Note: If the connection is not working, then contact your administrator.</p> <p>b Access the EWS.</p> <p>Can you open the EWS?</p>	The problem is solved.	Go to step 5.
<p>Step 5</p> <p>a Make sure that the cable connections to the printer and print server are secure. For more information, see the documentation that came with the print server.</p> <p>b Access the EWS.</p> <p>Can you open the EWS?</p>	The problem is solved.	Go to step 6.
<p>Step 6</p> <p>a Check if the web proxy servers are disabled. Note: If the servers are disabled, then contact your administrator.</p> <p>b Access the EWS.</p> <p>Can you open the EWS?</p>	The problem is solved.	Contact customer support .

Cannot connect the printer to the Wi-Fi network

Action	Yes	No
<p>Step 1</p> <p>Make sure that Active Adapter is set to Auto. From the home screen, touch Settings > Network/Ports > Network Overview > Active Adapter > Auto.</p> <p>Can the printer connect to the Wi-Fi network?</p>	The problem is solved.	Go to step 2.
<p>Step 2</p> <p>Check if the correct Wi-Fi network is selected. Note: Some routers may share the default SSID.</p> <p>Are you connecting to the correct Wi-Fi network?</p>	Go to step 4.	Go to step 3.
<p>Step 3</p> <p>Connect to the correct Wi-Fi network. For more information, see “Connecting the printer to a Wi-Fi network” on page 97.</p> <p>Can the printer connect to the Wi-Fi network?</p>	The problem is solved.	Go to step 4.

Action	Yes	No
<p>Step 4 Check the wireless security mode. From the home screen, touch Settings > Network/Ports > Wireless > Wireless Security Mode.</p> <p>Is the correct wireless security mode selected?</p>	Go to step 6.	Go to step 5.
<p>Step 5 Select the correct wireless security mode.</p> <p>Can the printer connect to the Wi-Fi network?</p>	The problem is solved.	Go to step 6.
<p>Step 6 Make sure that you entered the correct network password. Note: Take note of the spaces, numbers, and capitalization in the password.</p> <p>Can the printer connect to the Wi-Fi network?</p>	The problem is solved.	Contact customer support .

Hardware options problems

Cannot detect internal option

Action	Yes	No
<p>Step 1 Turn off the printer, wait for about 10 seconds, and then turn on the printer.</p> <p>Does the printer detect the internal option?</p>	The problem is solved.	Go to step 2.
<p>Step 2 Print the Menu Settings Page, and then check if the internal option appears in the Installed Features list.</p> <p>Is the internal option listed?</p>	Go to step 4.	Go to step 3.

Action	Yes	No
<p>Step 3</p> <p>Check if the internal option is installed properly into the controller board.</p> <ul style="list-style-type: none"> a Turn off the printer, and then unplug the power cord from the electrical outlet. b Make sure that the internal option is installed into the appropriate connector on the controller board. c Connect the power cord to the electrical outlet, and then turn on the printer. <p> CAUTION—POTENTIAL INJURY: To avoid the risk of fire or electrical shock, connect the power cord to an appropriately rated and properly grounded electrical outlet that is near the product and easily accessible.</p> <p>Does the printer detect the internal option?</p>	<p>The problem is solved.</p>	<p>Go to step 4.</p>
<p>Step 4</p> <ul style="list-style-type: none"> a Check if the internal option is available in the print driver. <p>Note: If necessary, manually add the internal option in the print driver to make it available for print jobs. For more information, see “Adding available options in the print driver” on page 56.</p> b Print the document. <p>Does the printer detect the internal option?</p>	<p>The problem is solved.</p>	<p>Contact customer support.</p>

Internal solutions port does not operate correctly

Action	Yes	No
<p>Step 1</p> <p>Print a menu settings page, and then check if the internal solutions port (ISP) appears in the Installed Features list.</p> <p>Is the ISP listed in the Installed Features list?</p>	<p>Go to step 3.</p>	<p>Go to step 2.</p>
<p>Step 2</p> <p>Remove, and then install the ISP. For more information, see “Installing an internal solutions port” on page 72.</p> <p>Note: Use a supported ISP.</p> <p>Does the ISP operate correctly?</p>	<p>The problem is solved.</p>	<p>Go to step 3.</p>

Action	Yes	No
<p>Step 3</p> <p>Check the cable and the ISP connection.</p> <ul style="list-style-type: none"> a Use the correct cable, and then make sure that it is securely connected to the ISP. b Check if the ISP solution interface cable is securely connected into the receptacle of the controller board. <p>Does the ISP operate correctly?</p>	<p>The problem is solved.</p>	<p>Contact customer support.</p>

Parallel or serial interface card does not operate correctly

Action	Yes	No
<p>Step 1</p> <p>Print a menu settings page, and then check if the parallel or serial interface card appears in the Installed Features list.</p> <p>Is the parallel or serial interface card listed in the Installed Features list?</p>	<p>Go to step 3.</p>	<p>Go to step 2.</p>
<p>Step 2</p> <p>Remove, and then install the parallel or serial interface card.</p> <p>For more information, see “Installing an internal solutions port” on page 72.</p> <p>Does the parallel or serial interface card operate correctly?</p>	<p>The problem is solved.</p>	<p>Go to step 3.</p>
<p>Step 3</p> <p>Check the connection between the cable and the parallel or serial interface card.</p> <p>Does the parallel or serial interface card operate correctly?</p>	<p>The problem is solved.</p>	<p>Contact customer support.</p>

Defective flash detected

Try one or more of the following:

- Replace the defective intelligent storage drive.
- From the home screen, touch **Continue** to ignore the message and continue printing.
- Cancel the current print job.

Not enough free space in flash memory for resources

Try one or more of the following:

- Touch **Continue** to clear the message and continue printing.
- Delete fonts, macros, and other data stored in the flash memory.
- Install a hard disk.



Note: Downloaded fonts and macros that are not previously stored in the flash memory are deleted.

Red light on the convenience stapler

Try one or more of the following:

- Close the staple access door.
- Remove the loose staples.

Note: After removing loose staples, two priming cycles are required before stapling. Insert a stack of paper into the stapler three times. The stapling starts at the third insertion.

- Replace the staple cartridge.

Issues with supplies

Replace cartridge, printer region mismatch

To correct this problem, purchase a cartridge with the correct region that matches the printer region, or purchase a worldwide cartridge.

- The first number in the message after 42 indicates the region of the printer.
- The second number in the message after 42 indicates the region of the cartridge.

Printer and toner cartridge regions

Region	Numeric code
Worldwide or Undefined region	0
North America (United States, Canada)	1
European Economic Area, Western Europe, Nordic countries, Switzerland	2
Asia Pacific	3
Latin America	4
Rest of Europe, Middle East, Africa	5
Australia, New Zealand	6
Invalid region	9

Note: To find the region settings of the printer and toner cartridge, print the print quality test pages. From the home screen, touch **Settings > Troubleshooting > Print Quality Test Pages**.

Refilled regular [color] cartridge

The printer has detected a Lexmark Regular cartridge that has been refilled with non-genuine toner by a party other than Lexmark.

Select **OK** to continue.

All printer component life indicators are designed to function with Lexmark supplies and parts and may deliver unpredictable results when using supplies or parts in your Lexmark printer that are remanufactured by parties other than Lexmark.

For more information, see the printer statement of limited warranty.

Non-Lexmark supply

The printer has detected a non-Lexmark supply or part installed in the printer.

Your Lexmark printer is designed to function best with genuine Lexmark supplies and parts. Use of third-party supplies or parts may affect the performance, reliability, or life of the printer and its imaging components.

All life indicators are designed to function with Lexmark supplies and parts and may deliver unpredictable results if third-party supplies or parts are used. Imaging component usage beyond the intended life may damage your Lexmark printer or associated components.

Warning—Potential Damage: Use of third-party supplies or parts can affect warranty coverage. Damage caused by the use of third-party supplies or parts may not be covered by the warranty.

To accept any and all of these risks and to proceed with the use of non-genuine supplies or parts in your printer, touch and hold the error message on the display using two fingers for 15 seconds. When a confirmation dialog box appears, touch **Continue**.

If you do not want to accept these risks, then remove the third-party supply or part from your printer and install a genuine Lexmark supply or part. For more information, see [“Using genuine Lexmark parts and supplies” on page 208](#).

If the printer does not print after clearing the error message, then reset the supply usage counter.

- 1** From the home screen, touch **Settings > Device > Maintenance > Configuration Menu > Supply Usage And Counters**.
- 2** Select the part or supply that you want to reset, and then touch **Start**.
- 3** Read the warning message, and then touch **Continue**.
- 4** Using two fingers, touch the display for 15 seconds to clear the message.

Note: If you are unable to reset the supply usage counters, then return the supply item to the place of purchase.

Paper feed problems

Envelope seals when printing

Action	Yes	No
<p>Step 1</p> <p>a Use an envelope that has been stored in a dry environment. Note: Printing on envelopes with high moisture content can seal the flaps.</p> <p>b Send the print job.</p> <p>Does the envelope seal when printing?</p>	Go to step 2.	The problem is solved.
<p>Step 2</p> <p>a Make sure that paper type is set to Envelope. From the home screen, touch Settings > Paper > Tray Configuration > Paper Size/Type.</p> <p>b Send the print job.</p> <p>Does the envelope seal when printing?</p>	Contact customer support .	The problem is solved.

Collated printing does not work

Action	Yes	No
<p>Step 1</p> <p>a From the home screen, touch Settings > Print > Layout > Collate.</p> <p>b Touch On [1,2,1,2,1,2].</p> <p>c Print the document.</p> <p>Is the document collated correctly?</p>	The problem is solved.	Go to step 2.
<p>Step 2</p> <p>a From the document that you are trying to print, open the Print dialog box, and then select Collate.</p> <p>b Print the document.</p> <p>Is the document collated correctly?</p>	The problem is solved.	Go to step 3.
<p>Step 3</p> <p>a Reduce the number of pages to print.</p> <p>b Print the document.</p> <p>Are the pages collated correctly?</p>	The problem is solved.	Contact customer support .



Tray linking does not work

Action	Yes	No
<p>Step 1</p> <p>a Check if the trays contain the same paper size and paper type.</p> <p>b Check if the paper guides are positioned correctly.</p> <p>c Print the document.</p> <p>Do the trays link correctly?</p>	The problem is solved.	Go to step 2.
<p>Step 2</p> <p>a From the home screen, touch Settings > Paper > Tray Configuration > Paper Size/Type.</p> <p>b Set the paper size and paper type to match the paper loaded in the linked trays.</p> <p>c Print the document.</p> <p>Do the trays link correctly?</p>	The problem is solved.	Go to step 3.
<p>Step 3</p> <p>a Make sure that Tray Linking is set to Automatic. For more information, see “Linking trays” on page 54.</p> <p>b Print the document.</p> <p>Do the trays link correctly?</p>	The problem is solved.	Contact customer support .

Paper frequently jams

Action	Yes	No
<p>Step 1</p> <p>a Remove the tray.</p> <p>b Check if paper is loaded correctly.</p> <p>Notes:</p> <ul style="list-style-type: none"> • Make sure that the paper guides are positioned correctly. • Make sure that the stack height is below the maximum paper fill indicator. • Make sure to print on recommended paper size and type. <p>c Insert the tray.</p> <p>d Print the document.</p> <p>Do paper jams occur frequently?</p>	Go to step 2.	The problem is solved.

Action	Yes	No
<p>Step 2</p> <p>a From the home screen, touch Settings > Paper > Tray Configuration > Paper Size/Type.</p> <p>b Set the correct paper size and type.</p> <p>c Print the document.</p> <p>Do paper jams occur frequently?</p>	Go to step 3.	The problem is solved.
<p>Step 3</p> <p>a Load paper from a fresh package.</p> <p>Note: Paper absorbs moisture due to high humidity. Store paper in its original wrapper until you are ready to use it.</p> <p>b Print the document.</p> <p>Do paper jams occur frequently?</p>	Contact customer support .	The problem is solved.

Jammed pages are not reprinted

Action	Yes	No
<p>a From the home screen, touch Settings > Device > Notifications > Jam Content Recovery.</p> <p>b In the Jam Recovery menu, touch On or Auto.</p> <p>c Print the document.</p> <p>Are the jammed pages reprinted?</p>	The problem is solved.	Contact customer support .

E-mailing problems

Disabling the “SMTP server not set up” error message

From the control panel, navigate to **Settings > E-mail > E-mail Setup > Disable “SMTP Server not set up” error > On**.

To prevent the error from happening again, do one or more of the following:

- Update the printer firmware. For more information, see the “Updating firmware” section.
- Configure the email SMTP settings. For more information, see [“Configuring the e-mail SMTP settings” on page 40](#).

Cannot send e-mails

Action	Yes	No
<p>Step 1 Make sure that the e-mail SMTP settings are configured correctly. For more information, see “Configuring the e-mail SMTP settings” on page 40.</p> <p>Can you send an e-mail?</p>	The problem is solved.	Go to step 2.
<p>Step 2 Make sure that you are using the correct password. Depending on your e-mail service provider, use your account password, app password, or authentication password. For more information, see “Configuring the e-mail SMTP settings” on page 40.</p> <p>Can you send an e-mail?</p>	The problem is solved.	Go to step 3.
<p>Step 3 Make sure that the printer is connected to a network and that the network is connected to the Internet.</p> <p>Can you send an e-mail?</p>	The problem is solved.	Contact customer support .

Faxing problems

Caller ID is not shown

Note: These instructions apply only to printers that support analog fax. For more information, see the [Setting up the printer to fax](#) section.

Action	Yes	No
<p>Enable caller ID. From the home screen, touch Settings > Fax > Fax Setup > Fax Receive Settings > Admin Controls > Enable Caller ID.</p> <p>Does the caller ID appear?</p>	The problem is solved.	Contact customer support .

Cannot send or receive faxes using analog fax

Action	Yes	No
<p>Step 1 Resolve any error messages that appear on the display.</p> <p>Can you send or receive a fax?</p>	The problem is solved.	Go to step 2.
<p>Step 2 Make sure that the cable connections for the following equipment are secure:</p> <ul style="list-style-type: none"> • Telephone • Handset • Answering machine <p>Can you send or receive a fax?</p>	The problem is solved.	Go to step 3.
<p>Step 3 Check for a dial tone.</p> <ul style="list-style-type: none"> • Call the fax number to check if it is working properly. • If you are using the On Hook Dial feature, then turn up the volume to check if you hear a dial tone. <p>Can you hear a dial tone?</p>	Go to step 5.	Go to step 4.
<p>Step 4 Check the telephone wall jack.</p> <ol style="list-style-type: none"> a Connect the analog telephone directly to the wall jack. b Listen for a dial tone. c If you do not hear a dial tone, then use a different telephone cable. d If you still do not hear a dial tone, then connect the analog telephone to a different wall jack. e If you hear a dial tone, then connect the printer to that wall jack. <p>Can you send or receive a fax?</p>	The problem is solved.	Go to step 5.



Action	Yes	No
<p>Step 5</p> <p>Check if the printer is connected to an analog phone service or to the correct digital connector.</p> <ul style="list-style-type: none"> • If you are using an Integrated Services for Digital Network (ISDN) telephone service, then connect to an analog telephone port of an ISDN terminal adapter. For more information, contact your ISDN provider. • If you are using DSL, then connect to a DSL filter or router that supports analog use. For more information, contact your DSL provider. • If you are using a private branch exchange (PBX) telephone service, then make sure that you are connecting to an analog connection on the PBX. If none exists, then consider installing an analog telephone line for the fax machine. <p>Can you send or receive a fax?</p>	<p>The problem is solved.</p>	<p>Go to step 6.</p>
<p>Step 6</p> <p>Temporarily disconnect other equipment and disable other telephone services.</p> <ol style="list-style-type: none"> a Disconnect other equipment (such as answering machines, computers, modems, or telephone line splitters) between the printer and the telephone line. b Disable call waiting and voice mail. For more information, contact your telephone company. <p>Can you send or receive a fax?</p>	<p>The problem is solved.</p>	<p>Go to step 7.</p>
<p>Step 7</p> <p>Scan the original document one page at a time.</p> <ol style="list-style-type: none"> a Dial the fax number. b Scan the document. <p>Can you send or receive a fax?</p>	<p>The problem is solved.</p>	<p>Contact customer support.</p>

Can receive but not send faxes using analog fax

Action	Yes	No
<p>Step 1 Load an original document properly into the ADF tray or on the scanner glass.</p> <p>Can you send faxes?</p>	The problem is solved.	Go to step 2.
<p>Step 2 Set up the shortcut number properly.</p> <ul style="list-style-type: none"> • Check if the shortcut number is set for the telephone number that you want to dial. • Dial the telephone number manually. <p>Can you send faxes?</p>	The problem is solved.	Contact customer support .

Can send but not receive faxes using analog fax

Action	Yes	No
<p>Step 1 Make sure that the paper source is not empty.</p> <p>Can you receive faxes?</p>	The problem is solved.	Go to step 2.
<p>Step 2 Check the ring count delay settings.</p> <p>From the home screen, touch Settings > Fax > Fax Setup > Fax Receive Settings > Rings to Answer.</p> <p>Can you receive faxes?</p>	The problem is solved.	Go to step 3.
<p>Step 3 If the printer is printing blank pages, then see “Blank or white pages” on page 273.</p> <p>Can you receive faxes?</p>	The problem is solved.	Contact customer support .

Cannot set up etherFAX

Action	Yes	No
<p>Step 1 Check the printer connectivity.</p> <p>a Print the Network Setup Page. From the home screen, touch Settings > Reports > Network > Network Setup Page.</p> <p>b Check the network status.</p> <p>Is the printer connected to the network?</p>	Go to step 3.	Go to step 2.

Action	Yes	No
<p>Step 2 Make sure that the printer is connected to a network and that the network is connected to the Internet.</p> <p>Can you set up etherFAX?</p>	The problem is solved.	Go to step 3.
<p>Step 3 Make sure that etherFAX is set up correctly. For more information, see “Setting up the fax function using etherFAX” on page 35.</p> <p>Can you set up etherFAX?</p>	The problem is solved.	Go to https://www.etherfax.net/lexmark .

Cannot send or receive faxes using etherFAX

Action	Yes	No
<p>Step 1 Make sure that the printer is connected to a network and that the network is connected to the Internet.</p> <p>Can you send or receive faxes using etherFAX?</p>	The problem is solved.	Go to step 2.
<p>Step 2 Make sure that etherFAX is set up correctly.</p> <p>a From the home screen, touch Settings > Fax > Fax Setup > General Fax Settings.</p> <p>b Make sure that you have the correct fax number.</p> <p>c Make sure that Fax Transport is set to etherFAX.</p> <p>Notes:</p> <ul style="list-style-type: none"> • This menu shows up only when more than one fax transport is available. • If the printer only has etherFAX installed, then it is automatically configured. <p>Can you send or receive faxes using etherFAX?</p>	The problem is solved.	Go to step 3.
<p>Step 3 Split large documents into smaller file sizes.</p> <p>Can you send or receive faxes using etherFAX?</p>	The problem is solved.	Go to https://www.etherfax.net/lexmark .



Poor fax print quality

Action	Yes	No
<p>Step 1 Make sure that there are no print quality defects.</p> <p>a From the home screen, touch Settings > Troubleshooting > Print Quality Test Pages.</p> <p>b Correct any print quality defects. For more information, see “Print quality is poor” on page 273.</p> <p>Is the fax print quality satisfactory?</p>	<p>The problem is solved.</p>	<p>Go to step 2.</p>
<p>Step 2 If you are using an analog fax, then decrease the incoming fax transmission speed.</p> <p>a From the home screen, touch Settings > Fax > Fax Setup > Fax Receive Settings > Admin Controls.</p> <p>b In the Max Speed menu, select a lower transmission speed.</p> <p>Is the fax print quality satisfactory?</p>	<p>The problem is solved.</p>	<p>Contact customer support.</p>

Missing information on the fax cover page

Action	No	Yes
<p>a Turn off the printer, wait for about 10 seconds, and then turn on the printer.</p> <p>b Send or retrieve the fax.</p> <p>Is there missing information on the fax cover page?</p>	<p>The problem is solved.</p>	<p>Contact customer support.</p>

Cannot send the fax cover page from the computer

Action	Yes	No
<p>Step 1</p> <p>a Make sure that the print driver is updated. For more information, see “Installing the printer software” on page 54.</p> <p>b Send the fax.</p> <p>Can you send the fax cover page?</p>	<p>The problem is solved.</p>	<p>Go to step 2.</p>



Action	Yes	No
<p>Step 2</p> <p>a From the document that you are trying to fax, open the Print dialog.</p> <p>b Select the printer, and then click Properties, Preferences, Options, or Setup.</p> <p>c Click Fax, and then clear the Always display settings prior to faxing setting.</p> <p>d Send the fax.</p> <p>Can you send the fax cover page?</p>	<p>The problem is solved.</p>	<p>Contact customer support.</p>

Scanning problems

Cannot scan to a computer

Action	Yes	No
<p>Step 1</p> <p>Perform a copy job.</p> <p>Is the copy job successful?</p>	<p>Go to step 3.</p>	<p>Go to step 2.</p>
<p>Step 2</p> <p>a Turn off the printer, wait for about 10 seconds, and then turn it back on.</p> <p>b Scan the document.</p> <p>Can you scan the document to a computer?</p>	<p>The problem is solved.</p>	<p>Go to step 3.</p>
<p>Step 3</p> <p>Check the printer connectivity.</p> <p>a Print the Network Setup Page. From the home screen, touch Settings > Reports > Network > Network Setup Page.</p> <p>b Check the network status.</p> <p>Is the printer connected to the network?</p>	<p>Go to step 5.</p>	<p>Go to step 4.</p>
<p>Step 4</p> <p>a Connect the printer to the network.</p> <p>b Scan the document.</p> <p>Can you scan the document to a computer?</p>	<p>The problem is solved.</p>	<p>Go to step 5.</p>

Action	Yes	No
<p>Step 5</p> <p>a Make sure that the printer and the computer are connected to the same network.</p> <p>b Scan the document.</p> <p>Can you scan the document to a computer?</p>	<p>The problem is solved.</p>	<p>Contact customer support.</p>

Cannot scan to a network folder

Action	Yes	No
<p>Step 1</p> <p>a Create a network folder shortcut.</p> <p>b Scan a document using the shortcut. For more information, see “Scanning to a network folder” on page 119.</p> <p>Can you scan a document and save it to a network folder?</p>	<p>The problem is solved.</p>	<p>Go to step 2.</p>
<p>Step 2</p> <p>Make sure that the network folder path and format are correct. For example, <code>//server_hostname/foldername/path</code>, where server_hostname is a fully qualified domain (FQDN) or IP address.</p> <p>Is the network folder path and format correct?</p>	<p>Go to step 3.</p>	<p>Go to step 4.</p>
<p>Step 3</p> <p>Make sure that you have a write access permission to the network folder.</p> <p>Can you scan a document and save it to a network folder?</p>	<p>The problem is solved.</p>	<p>Go to step 4.</p>

Action	Yes	No
<p>Step 4</p> <p>Update the network folder shortcut.</p> <p>a Open a web browser, and then type the printer IP address in the address field.</p> <p>Notes:</p> <ul style="list-style-type: none"> View the printer IP address on the home screen. The IP address appears as four sets of numbers separated by periods, such as 123.123.123.123. If you are using a proxy server, then temporarily disable it to load the web page correctly. <p>b Click Shortcuts, and then select a shortcut.</p> <p>Note: If you have multiple shortcut types, then select Network Folder.</p> <p>c In the Share Path field, type the network folder path.</p> <p>Notes:</p> <ul style="list-style-type: none"> If your share path is <code>\\server_hostname\foldername\path</code>, then type <code>//server_hostname/foldername/path</code>. Make sure that you use forward slashes when typing the share path. <p>d From the Authentication menu, select your authentication method.</p> <p>Note: If Authentication is set to “Use assigned username and password,” then in the User Name and Password fields, type your credentials.</p> <p>e Click Save.</p> <p>Can you scan a document and save it to a network folder?</p>	<p>The problem is solved.</p>	<p>Go to step 5.</p>
<p>Step 5</p> <p>Make sure that the printer and the network folder are connected to the same network.</p> <p>Can you scan a document and save it to a network folder?</p>	<p>The problem is solved.</p>	<p>Contact customer support.</p>

Partial copies of document or photo

Action	Yes	No
<p>Step 1</p> <p>a Make sure that the document or photo is loaded facedown on the upper left corner of the scanner glass.</p> <p>b Copy the document or photo.</p> <p>Is the document or photo copied correctly?</p>	<p>The problem is solved.</p>	<p>Go to step 2.</p>



Action	Yes	No
<p>Step 2</p> <p>a Match the paper size setting and the paper loaded in the tray.</p> <p>b Copy the document or photo.</p> <p>Is the document or photo copied correctly?</p>	<p>The problem is solved.</p>	<p>Contact customer support.</p>

Poor copy quality

Action	Yes	No
<p>Step 1</p> <p>a Clean the scanner glass and the ADF glass with a damp, soft, lint-free cloth. If your printer has a second ADF glass inside the ADF, then also clean that glass. For more information, see “Cleaning the scanner” on page 250.</p> <p>b Make sure that the document or photo is loaded facedown on the upper left corner of the scanner glass.</p> <p>c Copy the document or photo.</p> <p>Is the copy quality satisfactory?</p>	<p>The problem is solved.</p>	<p>Go to step 2.</p>
<p>Step 2</p> <p>a Check the quality of the original document or photo.</p> <p>b Adjust the scan quality settings.</p> <p>c Copy the document or photo.</p> <p>Is the copy quality satisfactory?</p>	<p>The problem is solved.</p>	<p>Contact customer support.</p>

Vertical dark streaks on output when scanning from the ADF

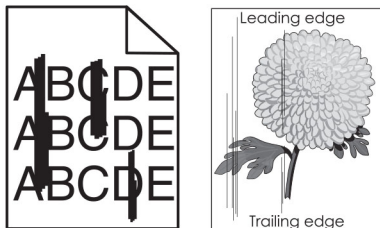

Action	Yes	No
<p>Step 1</p> <ul style="list-style-type: none"> a Open the scanner cover. b Using a damp, soft, lint-free cloth, wipe the ADF glass and the white underside of the scanner cover. c Close the scanner cover. <p>Do vertical streaks appear on scanned documents?</p>	Go to step 2.	The problem is solved.
<p>Step 2</p> <ul style="list-style-type: none"> a Open the ADF cover. b Using a damp, soft, lint-free cloth, wipe the ADF glass and the white underside of the ADF cover. c Close the ADF cover. <p>Do vertical streaks appear on scanned documents?</p>	Contact customer support .	The problem is solved.

Jagged image or text when scanning from the ADF

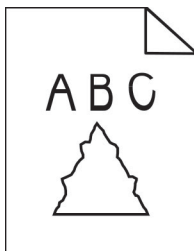

Action	Yes	No
<ul style="list-style-type: none"> a Load 50 sheets of clean, plain paper into the ADF. Note: The plain paper helps clean or remove dust and other coating from the ADF feed rollers. b From the home screen, touch . c Load an original document into the ADF. d Scan the document. <p>Do jagged images or texts appear on the output?</p>	Contact customer support .	The problem is solved.

Scan job was not successful

Action	Yes	No
<p>Step 1 Check the cable connections.</p> <ul style="list-style-type: none"> a Make sure that the Ethernet or USB cable is securely connected to the computer and the printer. b Resend the scan job. <p>Is the scan job successful?</p>	The problem is solved.	Go to step 2.
<p>Step 2 Check the file you want to scan.</p> <ul style="list-style-type: none"> a Make sure that the file name is not already used in the destination folder. b Make sure that the document or photo you want to scan is not open in another application. c Resend the scan job. <p>Is the scan job successful?</p>	The problem is solved.	Go to step 3.
<p>Step 3</p> <ul style="list-style-type: none"> a Make sure that the Append time stamp or the Overwrite existing file check box is selected in the destination configuration settings. b Resend the scan job. <p>Is the scan job successful?</p>	The problem is solved.	Contact customer support .

Scanner does not close

Action	Yes	No
<p>Remove obstructions that keep the scanner cover open.</p> <p>Did the scanner cover close correctly?</p>	The problem is solved.	Contact customer support .

Scanning takes too long or freezes the computer

Action	Yes	No
<p>Close all applications that are interfering with the scan.</p> <p>Does scanning take too long or freeze the computer?</p>	Contact customer support .	The problem is solved.

Scanner does not respond

Action	Yes	No
<p>Step 1</p> <p>a Check if the power cord is connected properly to the printer and the electrical outlet.</p> <p> CAUTION—POTENTIAL INJURY: To avoid the risk of fire or electrical shock, connect the power cord to an appropriately rated and properly grounded electrical outlet that is near the product and easily accessible.</p> <p>b Copy or scan the document.</p> <p>Is the scanner responding?</p>	The problem is solved.	Go to step 2.
<p>Step 2</p> <p>a Check if the printer is turned on.</p> <p>b Resolve any error messages that appear on the display.</p> <p>c Copy or scan the document.</p> <p>Is the scanner responding?</p>	The problem is solved.	Go to step 3.
<p>Step 3</p> <p>a Turn off the printer, wait for about 10 seconds, and then turn the printer on.</p> <p>b Copy or scan the document.</p> <p>Is the scanner responding?</p>	The problem is solved.	Contact customer support .

Adjusting scanner registration

- From the home screen, touch **Settings > Device > Maintenance > Configuration Menu > Scanner Configuration > Scanner Manual Registration**.
- In the Print Quick Test menu, touch **Start**.
- Place the Print Quick Test page on the scanner glass, and then touch **Flatbed Registration**.
- In the Copy Quick Test menu, touch **Start**.
- Compare the Copy Quick Test page with the original document.

Note: If the margins of the test page are different from the original document, then adjust Left Margin and Top Margin.
- Repeat [step 4](#) and [step 5](#) until the margins of the Copy Quick Test page closely match the original document.

Adjusting ADF registration

- From the home screen, touch **Settings > Device > Maintenance > Configuration Menu > Scanner Configuration > Scanner Manual Registration**.
- In the Print Quick Test menu, touch **Start**.

3 Place the Print Quick Test page on the ADF tray.

4 Touch **Front ADF Registration** or **Rear ADF Registration**.

Notes:

- To align Front ADF Registration, place the test page faceup, short edge first into the ADF.
- To align Rear ADF Registration, place the test page facedown, short edge first into the ADF.

5 In the Copy Quick Test menu, touch **Start**.

6 Compare the Copy Quick Test page with the original document.

Note: If the margins of the test page are different from the original document, then adjust Horizontal Adjust and Top Margin.

7 Repeat [step 5](#) and [step 6](#) until the margins of the Copy Quick Test page closely match the original document.

Color quality problems

Modifying the colors in printed output

1 From the home screen, touch **Settings > Print > Quality > Advanced Imaging > Color Correction**.

2 In the Color Correction menu, touch **Manual > Color Correction Content**.

3 Choose the appropriate color conversion setting.

Object type	Color conversion tables
RGB Image RGB Text RGB Graphics	<ul style="list-style-type: none"> • Vivid—Produces brighter, more saturated colors and may be applied to all incoming color formats. • sRGB Display—Produces an output that approximates the colors shown on a computer monitor. Black toner usage is optimized for printing photographs. • Display-True Black—Produces an output that approximates the colors shown on a computer monitor. This setting uses only black toner to create all levels of neutral gray. • sRGB Vivid—Provides an increased color saturation for the sRGB Display color correction. Black toner usage is optimized for printing business graphics. • Off
CMYK Image CMYK Text CMYK Graphics	<ul style="list-style-type: none"> • US CMYK—Applies color correction to approximate the Specifications for Web Offset Publishing (SWOP) color output. • Euro CMYK—Applies color correction to approximate Euroscale color output. • Vivid CMYK—Increases the color saturation of the US CMYK color correction setting. • Off

FAQ about color printing

What is RGB color?

RGB color is a method of describing colors by indicating the amount of red, green, or blue used to produce a certain color. Red, green, and blue light can be added in various amounts to produce a large range of colors observed in nature. Computer screens, scanners, and digital cameras use this method to display colors.

What is CMYK color?

CMYK color is a method of describing colors by indicating the amount of cyan, magenta, yellow, and black used to reproduce a particular color. Cyan, magenta, yellow, and black inks or toners can be printed in various amounts to produce a large range of colors observed in nature. Printing presses, inkjet printers, and color laser printers create colors in this manner.

How is color specified in a document to be printed?

Software programs are used to specify and modify the document color using RGB or CMYK color combinations. For more information, see the software program Help topics.

How does the printer know what color to print?

When printing a document, information describing the type and color of each object is sent to the printer and is passed through color conversion tables. Color is translated into the appropriate amounts of cyan, magenta, yellow, and black toner used to produce the color you want. The object information determines the application of color conversion tables. For example, it is possible to apply one type of color conversion table to text while applying a different color conversion table to photographic images.

What is manual color correction?

When manual color correction is enabled, the printer employs user-selected color conversion tables to process objects. Manual color correction settings are specific to the type of object being printed (text, graphics, or images). It is also specific to how the color of the object is specified in the software program (RGB or CMYK combinations). To apply a different color conversion table manually, see [“Modifying the colors in printed output” on page 339](#).

If the software program does not specify colors with RGB or CMYK combinations, then manual color correction is not useful. It is also not effective if the software program or the computer operating system controls the adjustment of colors. In most situations, setting the Color Correction to Auto generates preferred colors for the documents.

How can I match a particular color (such as a corporate logo)?

From the printer Quality menu, nine types of Color Samples sets are available. These sets are also available from the Color Samples page of the Embedded Web Server. Selecting any sample set generates multiple-page prints consisting of hundreds of colored boxes. Each box contains a CMYK or RGB combination, depending on the table selected. The observed color of each box is obtained by passing the CMYK or RGB combination labeled on the box through the selected color conversion table.

By examining Color Samples sets, you can identify the box with color closest to the color being matched. The color combination labeled on the box can then be used for modifying the color of the object in a software program. For more information, see the software program Help topics. Manual color correction may be necessary to use the selected color conversion table for the particular object.

Selecting which Color Samples set to use for a particular color-matching problem depends on:

- The Color Correction setting being used (Auto, Off, or Manual)
- The type of object being printed (text, graphics, or images)
- How the color of the object is specified in the software program (RGB or CMYK combinations)

If the software program does not specify colors with RGB or CMYK combinations, then the Color Samples pages are not useful. Additionally, some software programs adjust the RGB or CMYK combinations specified in the program through color management. In these situations, the printed color may not be an exact match of the Color Samples pages.

The print appears tinted

Action	Yes	No
<p>Step 1 Perform Color Adjust.</p> <p>a From the home screen, touch Settings > Print > Quality > Advanced Imaging > Color Adjust.</p> <p>b Print the document.</p> <p>Does the print appear tinted?</p>	Go to step 2.	The problem is solved.
<p>Step 2 Perform Color Balance.</p> <p>a From the home screen, touch Settings > Print > Quality > Advanced Imaging > Color Balance.</p> <p>b Adjust the settings.</p> <p>c Print the document.</p> <p>Does the print appear tinted?</p>	Contact customer support .	The problem is solved.

Contacting customer support

Before contacting customer support, make sure to have the following information:

- Printer problem
- Error message
- Printer model type and serial number

Go to <http://support.lexmark.com> to receive e-mail or chat support, or browse through the library of manuals, support documentation, drivers, and other downloads.

Technical support via telephone is also available. In the U.S. or Canada, call 1-800-539-6275. For other countries or regions, go to <http://support.lexmark.com>.

Recycle and dispose

Recycling Lexmark products

To return Lexmark products for recycling:

- 1 Go to www.lexmark.com/recycle.
- 2 Select the product you want to recycle.

Note: Printer supplies and hardware not listed in the Lexmark Collection and Recycling Program may be recycled through your local recycling center.

Recycling Lexmark packaging

Lexmark continually strives to minimize packaging. Less packaging helps to ensure that Lexmark printers are transported in the most efficient and environmentally sensitive manner and that there is less packaging to dispose of. These efficiencies result in fewer greenhouse emissions, energy savings, and natural resource savings. Lexmark also offers recycling of packaging components in some countries or regions. For more information, go to www.lexmark.com/recycle, and then choose your country or region. Information on available packaging recycling programs is included with the information on product recycling.

Lexmark cartons are 100% recyclable where corrugated recycling facilities exist. Facilities may not exist in your area.

The foam used in Lexmark packaging is recyclable where foam recycling facilities exist. Facilities may not exist in your area.

When you return a cartridge to Lexmark, you can reuse the box that the cartridge came in. Lexmark recycles the box.

Notices

Product information

Product name:

Lexmark CX730de, Lexmark CX735adse, Lexmark CX737adzse, Lexmark XC4342, Lexmark XC4352 MFPs

Machine type:

7530

Models:

236, 239, 678, 679, 878

Edition notice

July 2024

The following paragraph does not apply to any country where such provisions are inconsistent with local law: LEXMARK INTERNATIONAL, INC., PROVIDES THIS PUBLICATION "AS IS" WITHOUT WARRANTY OF ANY KIND, EITHER EXPRESS OR IMPLIED, INCLUDING, BUT NOT LIMITED TO, THE IMPLIED WARRANTIES OF MERCHANTABILITY OR FITNESS FOR A PARTICULAR PURPOSE. Some states do not allow disclaimer of express or implied warranties in certain transactions; therefore, this statement may not apply to you.

This publication could include technical inaccuracies or typographical errors. Changes are periodically made to the information herein; these changes will be incorporated in later editions. Improvements or changes in the products or the programs described may be made at any time.

References in this publication to products, programs, or services do not imply that the manufacturer intends to make these available in all countries in which it operates. Any reference to a product, program, or service is not intended to state or imply that only that product, program, or service may be used. Any functionally equivalent product, program, or service that does not infringe any existing intellectual property right may be used instead. Evaluation and verification of operation in conjunction with other products, programs, or services, except those expressly designated by the manufacturer, are the user's responsibility.

For Lexmark technical support, go to <http://support.lexmark.com>.

For information on Lexmark's privacy policy governing the use of this product, go to www.lexmark.com/privacy.

For information on supplies and downloads, go to www.lexmark.com.

© 2022 Lexmark International, Inc.

All rights reserved.

GOVERNMENT END USERS

The Software Program and any related documentation are "Commercial Items," as that term is defined in 48 C.F.R. 2.101, "Computer Software" and "Commercial Computer Software Documentation," as such terms are used in 48 C.F.R. 12.212 or 48 C.F.R. 227.7202, as applicable. Consistent with 48 C.F.R. 12.212 or 48 C.F.R. 227.7202-1 through 227.7207-4, as applicable, the Commercial Computer Software and Commercial Software

Documentation are licensed to the U.S. Government end users (a) only as Commercial Items and (b) with only those rights as are granted to all other end users pursuant to the terms and conditions herein.

Trademarks

Lexmark, the Lexmark logo, and MarkNet are trademarks or registered trademarks of Lexmark International, Inc. in the United States and/or other countries.

Gmail, Android, Google Play, and Google Chrome are trademarks of Google LLC.

Macintosh, macOS, Safari, and AirPrint are trademarks of Apple Inc., registered in the U.S. and other countries. App Store and iCloud are service marks of Apple Inc., registered in the U.S. and other countries. Use of the Works with Apple badge means that an accessory has been designed to work specifically with the technology identified in the badge and has been certified by the developer to meet Apple performance standards.

Microsoft, Internet Explorer, Microsoft 365, Microsoft Edge, Outlook, and Windows are trademarks of the Microsoft group of companies.

The Mopria® word mark is a registered and/or unregistered trademark of Mopria Alliance, Inc. in the United States and other countries. Unauthorized use is strictly prohibited.

PCL® is a registered trademark of the Hewlett-Packard Company. PCL is Hewlett-Packard Company’s designation of a set of printer commands (language) and functions included in its printer products. This printer is intended to be compatible with the PCL language. This means the printer recognizes PCL commands used in various application programs, and that the printer emulates the functions corresponding to the commands.

PostScript is a registered trademark of Adobe Systems Incorporated in the United States and/or other countries.

Wi-Fi® and Wi-Fi Direct® are registered trademarks of Wi-Fi Alliance®.

All other trademarks are the property of their respective owners.

Licensing notices

All licensing notices associated with this product can be viewed from the CD:\NOTICES directory of the installation software CD.

Noise emission levels

The following measurements were made in accordance with ISO 7779 and reported in conformance with ISO 9296.

Note: Some modes may not apply to your product.

1-meter average sound pressure, dBA	
Printing	One-sided: 52 (CX730de, XC4342); 53 (CX735, CX737, XC4352) Two-sided: 53 (CX730, XC4342); 55 (CX735, CX737, XC4352)
Scanning	51



1-meter average sound pressure, dBA	
Copying	Mono: 55 (CX730, XC4342); 56 (CX735, CX737, XC4352) Color: 51 (CX730, XC4342); 52 (CX735, CX737, XC4352)
Ready	14

Values are subject to change. See www.lexmark.com for current values.

Waste from Electrical and Electronic Equipment (WEEE) directive



The WEEE logo signifies specific recycling programs and procedures for electronic products in countries of the European Union. We encourage the recycling of our products.

If you have further questions about recycling options, visit the Lexmark Web site at www.lexmark.com for your local sales office phone number.

India E-Waste notice



This product including components, consumables, parts and spares complies with the “India E-Waste Rules” and prohibits use of lead, mercury, hexavalent chromium, polybrominated biphenyls or polybrominated diphenyl ethers in concentrations exceeding 0.1% by weight and 0.01% by weight for cadmium, except for the exemption set in the Rule.

Lithium-ion rechargeable battery

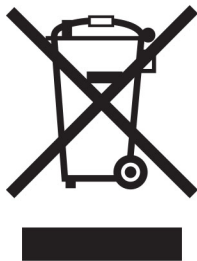

This product may contain a coin-cell, lithium-ion rechargeable battery, which should only be removed by a trained technician. Crossed-out wheeled bin means the product should not be discarded as unsorted waste but must be sent to separate collection facilities for recovery and recycling. In the event the battery is removed, do not dispose of the battery in your household waste. There may be separate collection systems for batteries in your local community, such as a battery-recycling drop-off location. The separate collection of waste batteries assures appropriate treatment of waste including reuse and recycling and prevents any potential negative effects on human health and environment. Please responsibly dispose of the batteries.

Regulation (EU) 2023/1542

Regulation (EU) 2023/1542

This product may contain a coin-cell lithium rechargeable battery. This battery complies with Regulation (EU) 2023/1542. Compliance is indicated by the CE marking:





This product may contain one of the following coin-cell batteries:

- Battery identification: Seiko Model Number MS621FE
Manufacturer: Seiko Instruments Inc.
Manufacturer address: 8, Nakase 1-chome, Mihama-ku, Chiba-shi, Chiba 261-8507, Japan
- Battery identification: Panasonic Model Number ML621
Manufacturer: Panasonic Energy Co., Ltd.
Manufacturer address: 1-1 Matsushita-cho, Moriguchi City, Osaka 570-8511, Japan
- Battery identification: FDK Model Number ML621
Manufacturer: FDK Corporation
Manufacturer address: Shibaura Crystal Shinagawa, 1-6-41 Konan, Minato-ku, Tokyo 108-8212 Japan

Environmental labeling for packaging

Per Commission Regulation Decision 97/129/EC Legislative Decree 152/2006, the product packaging may contain one or more of the following symbols.

	This symbol indicates that the packaging may contain corrugated fiberboard.
	This symbol indicates that the packaging may contain non-corrugated fiberboard.
	This symbol indicates that the packaging may contain paper.

For more information, go to www.lexmark.com/recycle, and then choose your country or region. Information on available packaging recycling programs is included with the information on product recycling.

Product disposal

Do not dispose of the printer or supplies in the same manner as normal household waste. Consult your local authorities for disposal and recycling options.

Returning Lexmark cartridges for reuse or recycling

The Lexmark Cartridge Collection Program allows you to return used cartridges for free to Lexmark for reuse or recycling. One hundred percent of the empty cartridges returned to Lexmark are either reused or demanufactured for recycling. The boxes used to return the cartridges are also recycled.

To return Lexmark cartridges for reuse or recycling, do the following:

- 1 Go to www.lexmark.com/recycle.
- 2 Select your country or region.
- 3 Select **Lexmark Cartridge Collection Program**.
- 4 Follow the instructions on the screen.

Static sensitivity notice

Static sensitivity notice

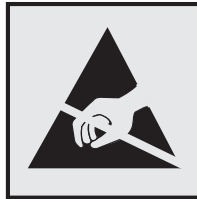

This symbol identifies static-sensitive parts. Do not touch the areas near these symbols without first touching a metal surface in an area away from the symbol.

To prevent damage from electrostatic discharge when performing maintenance tasks such as clearing paper jams or replacing supplies, touch any exposed metal frame of the printer before accessing or touching interior areas of the printer even if the symbol is not present.

ENERGY STAR

Any Lexmark product bearing the ENERGY STAR® emblem on the product or on a start-up screen is certified to comply with Environmental Protection Agency (EPA) ENERGY STAR requirements as of the date of manufacture.



Temperature information

Operating temperature and relative humidity	10 to 32.2°C (50 to 90°F) and 15 to 80% RH 15.6 to 32.2°C (60 to 90°F) and 8 to 80% RH Maximum wet-bulb temperature ² : 22.8°C (73°F) Non-condensing environment
Printer / cartridge / imaging unit long-term storage ¹	15.6 to 32.2°C (60 to 90°F) and 8 to 80% RH Maximum wet-bulb temperature ² : 22.8°C (73°F)
Printer / cartridge / imaging unit short-term shipping	-40 to 40°C (-40 to 104°F)
<p>¹ Supplies shelf life is approximately 2 years. This is based on storage in a standard office environment at 22°C (72°F) and 45% humidity.</p> <p>² Wet-bulb temperature is determined by the air temperature and the relative humidity.</p>	

Laser notice

The printer is certified in the U.S. to conform to the requirements of DHHS 21 CFR, Chapter I, Subchapter J for Class I (1) laser products, and elsewhere is certified as a Class 1 consumer laser product conforming to the requirements of IEC 60825-1:2014, EN 60825-1:2014+A11:2021, and EN 50689:2021.

Class I laser products are not considered to be hazardous. The laser system and printer are designed so there is never any human access to laser radiation above a Class I level during normal operation, user maintenance, or prescribed service conditions. The printer has a non-serviceable printhead assembly that contains a laser with the following specifications:

Class: IIIb (3b) AlGaAs

Nominal output power (milliwatts): 12

Wavelength (nanometers): 770–800

Power consumption

Product power consumption

The following table documents the power consumption characteristics of the product.

Note: Some modes may not apply to your product.

Mode	Description	Power consumption (Watts)
Printing	The product is generating hard-copy output from electronic inputs.	One-sided: 630 (CX730, XC4342); 760 (CX735, CX737, XC4352) Two-sided: 520 (CX730, XC4342); 640 (CX735, CX737, XC4352)
Copy	The product is generating hard-copy output from hard-copy original documents.	640 (CX730, XC4342); 800 (CX735, CX737, XC4352)
Scan	The product is scanning hard-copy documents.	44.5 (CX730, XC4342); 45.0 (CX735, CX737, XC4352)
Ready	The product is waiting for a print job.	31.5 (CX730, XC4342); 32.0 (CX735, CX737, XC4352)
Sleep Mode	The product is in a high-level energy-saving mode.	1.0 (CX730, XC4342); 1.2 (CX735, CX737, XC4352)
Hibernate	The product is in a low-level energy-saving mode.	0.1
Off	The product is plugged into an electrical outlet, but the power switch is turned off.	0.1

The power consumption levels listed in the previous table represent time-averaged measurements. Instantaneous power draws may be substantially higher than the average.

Values are subject to change. See www.lexmark.com for current values.

Sleep Mode

This product is designed with an energy-saving mode called *Sleep Mode*. The Sleep Mode saves energy by lowering power consumption during extended periods of inactivity. The Sleep Mode is automatically engaged after this product is not used for a specified period of time, called the *Sleep Mode Timeout*.

Factory default Sleep Mode Timeout for this product (in minutes):	15
---	----



By using the configuration menus, the Sleep Mode Timeout can be modified between 1 minute and 120 minutes, or between 1 minute and 114 minutes, depending on the printer model. If the printer speed is less than or equal to 30 pages per minute, then you can set the timeout only up to 60 minutes or 54 minutes, depending on the printer model. Setting the Sleep Mode Timeout to a low value reduces energy consumption, but may increase the response time of the product. Setting the Sleep Mode Timeout to a high value maintains a fast response, but uses more energy.

Some models support a *Deep Sleep Mode*, which further reduces power consumption after longer periods of inactivity.

Hibernate Mode

This product is designed with an ultra-low power operating mode called *Hibernate mode*. When operating in Hibernate Mode, all other systems and devices are powered down safely.

The Hibernate mode can be entered in any of the following methods:

- Using the Hibernate Timeout
- Using the Schedule Power modes

Factory default Hibernate Timeout for this product in all countries or regions	3 days
--	--------

The amount of time the printer waits after a job is printed before it enters Hibernate mode can be modified between one hour and one month.

Notes on EPEAT-registered imaging equipment products:

- Standby power level occurs in Hibernate or Off mode.
- The product shall automatically power down to a standby power level of ≤ 1 W. The auto standby function (Hibernate or Off) shall be enabled at product shipment.

Off mode

If this product has an off mode which still consumes a small amount of power, then to completely stop product power consumption, disconnect the power supply cord from the electrical outlet.

Total energy usage

Total energy usage

It is sometimes helpful to estimate the total product energy usage. Since power consumption claims are provided in power units of Watts, the power consumption should be multiplied by the time the product spends in each mode in order to calculate energy usage. The total product energy usage is the sum of each mode's energy usage.

Applicability of Regulation (EU) 2019/2015 and (EU) 2019/2020

Per Commission Regulation (EU) 2019/2015 and (EU) 2019/2020, the light source contained within this product or its component is intended to be used for Image Capture or Image Projection only, and is not intended for use in other applications.

Thailand NBTC technical standards conformity statement

คำประกาศเรื่องการเป็นไปตามมาตรฐานทางเทคนิคของ กสทช. ประเทศไทย

This telecommunication equipment conforms to the technical standards or requirements of NBTC.

เครื่องโทรคมนาคมและอุปกรณ์นี้มีความสอดคล้องตามมาตรฐานหรือข้อกำหนดทางเทคนิคของ กสทช.

Regulatory notices for telecommunication terminal equipment

Regulatory notices for telecommunication terminal equipment

This section contains regulatory information pertaining to products that contain the analog facsimile card:

Lexmark Regulatory Type/Model Number:

LEX-M14-002 or LEX-M03-002

Notice to users of the US telephone network: FCC requirements

This equipment complies with Part 68 of the FCC rules and the requirements adopted by the Administrative Council for Terminal Attachments (ACTA). On the back of this equipment is a label that contains, among other information, a product identifier in the format US:AAAEQ##TXXXX. If requested, this number must be provided to your telephone company.

This equipment uses the RJ-11C Universal Service Order Code (USOC) jack.

A plug and jack used to connect this equipment to the premises' wiring and telephone network must comply with the applicable FCC Part 68 rules and requirements adopted by the ACTA. Use a compliant telephone cord (RJ-11) that is 26 AWG or larger when connecting this product to the public switched telephone network. See your setup documentation for more information.

The Ringer Equivalence Number (REN) is used to determine the number of devices that may be connected to a telephone line. Excessive RENs on a telephone line may result in the devices not ringing in response to an incoming call. In most but not all areas, the sum of RENs should not exceed five (5.0). To be certain of the number of devices that may be connected to a line, as determined by the total RENs, contact your local telephone company. For products approved after July 23, 2001, the REN for this product is part of the product identifier that has the format US:AAAEQ##TXXXX. The digits represented by ## are the REN without a decimal point (for example, 03 is a REN of 0.3). For earlier products, the REN is shown separately on the label.

If this equipment causes harm to the telephone network, the telephone company will notify you in advance that temporary discontinuance of service may be required. If advance notice is not practical, the telephone company will notify the customer as soon as possible. You will also be advised of your right to file a complaint with the FCC.

The telephone company may make changes in its facilities, equipment, operations or procedures that could affect the operation of this equipment. If this happens, the telephone company will provide advance notice in order for you to make necessary modifications to maintain uninterrupted service.

If you experience trouble with this equipment, for repair or warranty information, contact Lexmark International, Inc. at www.lexmark.com or your Lexmark representative. If the equipment is causing harm to the telephone network, the telephone company may request that you disconnect the equipment until the problem is resolved.

This equipment contains no user serviceable parts. For repair and warranty information, contact Lexmark International, Inc. See the previous paragraph for contact information.

Connection to party line service is subject to state tariffs. Contact the state public utility commission, public service commission, or corporation commission for information.

If your home has specially wired alarm equipment connected to the telephone line, ensure the installation of this equipment does not disable your alarm equipment. If you have questions about what will disable alarm equipment, consult your telephone company or a qualified installer.

The Telephone Consumer Protection Act of 1991 makes it unlawful for any person to use a computer or other electronic device, including fax machines, to send any message unless said message clearly contains in a margin at the top or bottom of each transmitted page or on the first page of the transmission, the date and time it is sent and an identification of the business or other entity, or other individual sending the message, and the telephone number of the sending machine or such business, other entity, or individual. (The telephone number provided may not be a 900 number or any other number for which charges exceed local or long-distance transmission charges.)

See your user documentation in order to program this information into your fax machine.

Notice to users of the Canadian telephone network

This product meets the applicable Innovation, Science and Economic Development Canada technical specifications.

The Ringer Equivalence Number (REN) indicates the maximum number of devices allowed to be connected to a telephone interface. The termination of an interface may consist of any combination of devices subject only to the requirement that the sum of the RENs of all the devices not exceed five. The REN is located on the product label.

This equipment uses CA11A telephone jacks.

Avis réservé aux utilisateurs du réseau téléphonique du Canada

Ce produit est conforme aux spécifications techniques d'Innovation, Sciences et Développement économique Canada.

Le numéro REN (ringer equivalence number : numéro d'équivalence de sonnerie) indique le nombre maximum d'appareils pouvant être connectés à l'interface téléphonique. En bout de ligne, le nombre d'appareils qui peuvent être connectés n'est pas directement limité, mais la somme des REN de ces appareils ne doit pas dépasser cinq. Le numéro REN est indiqué sur l'étiquette produit.

Cet équipement utilise des prises de téléphone CA11A.

Notice to users of the New Zealand telephone network

The following are special conditions for the Facsimile User Instructions. The grant of a telepermit for any item of terminal equipment indicates only that Spark has accepted that the item complies with minimum conditions for connection to its network. It indicates no endorsement of the product by Spark, nor does it provide any sort of warranty. Above all, it provides no assurance that any item will work correctly in all respects with another item of telepermitted equipment of a different make or model, nor does it imply that any product is compatible with all of Spark's network services.

This equipment shall not be set up to make automatic calls to the Spark "111" Emergency Service.

This equipment may not provide for the effective hand-over of a call to another device connected to the same line.

This equipment should not be used under any circumstances that may constitute a nuisance to other Spark customers.

This equipment is not capable, under all operating conditions, of correct operation at the higher speeds for which it is designed. Spark will accept no responsibility should difficulties arise in such circumstances.

The decadic (or pulse) dialing on this device is unsuitable for use on the Spark network in New Zealand.

For correct operation, the total of all the Ringer Equivalence Numbers (RENs) of all parallel devices connected to the same telephone line may not exceed 5. The REN of this device is located on the label.

This device uses an RJ-11C modular connector. Contact your point of purchase if a BT adapter is required. The Lexmark part number is 80D1873.

Some parameters required for compliance with Spark's telepermit requirements are dependent on the equipment associated with this device. The associated equipment shall be set to operate within the following limits for compliance to Spark's specifications:

- There shall be no more than 10 call attempts to the same number within any 30 minute period for any single manual call initiation, and
- The equipment shall go on-hook for a period of not less than 30 seconds between the end of one attempt and the beginning of the next call attempt.
- The equipment shall be set to ensure that automatic calls to different numbers are spaced such that there is not less than 5 seconds between the end of one call attempt and the beginning of another.

Japanese telecom notice

The installed optional modem is in compliance with Japanese Telecommunication Law and has been Certified by JATE, with the following Certification Number:

A18-0046001 or A11-0160001JP

	Lexmark International, Inc.
	LEX-M14-002 or LEX-M03-002
	A18-0046001 or A11-0160001JP

Using this product in Switzerland

This product requires a Swiss billing tone filter (Lexmark part number 80D1877) to be installed on any line which receives metering pulses in Switzerland.

Utilisation de ce produit en Suisse

Cet appareil nécessite l'utilisation d'un filtre de tonalité de facturation suisse (n° de référence Lexmark : 80D1877) devant être installé sur toute ligne recevant des impulsions de comptage en Suisse.

Verwendung dieses Produkts in der Schweiz

Für dieses Produkt muss ein schweizerischer Billing Tone Filter zur Zählzeichenübertragung (Lexmark Teilenummer 80D1877) für jede Leitung installiert werden, über die in der Schweiz Zeitsteuertakte übertragen werden.

Usò del prodotto in Svizzera

Questo prodotto richiede un filtro toni Billing svizzero, (codice Lexmark 80D1877) da installare su tutte le linee che ricevono impulsi remoti in Svizzera.

Federal Communications Commission (FCC) compliance information statement

This product has been tested and found to comply with the limits for a Class A digital device, pursuant to Part 15 of the FCC Rules. Operation is subject to the following two conditions: (1) this device may not cause harmful interference, and (2) this device must accept any interference received, including interference that may cause undesired operation.

The FCC Class A limits are designed to provide reasonable protection against harmful interference when the equipment is operated in a commercial environment. This equipment generates, uses, and can radiate radio frequency energy and, if not installed and used in accordance with the instruction manual, may cause harmful interference to radio communications. Operation of this equipment in a residential area is likely to cause harmful interference, in which case the user will be required to correct the interference at his own expense.

The manufacturer is not responsible for any radio or television interference caused by using other than recommended cables or by unauthorized changes or modifications to this equipment. Unauthorized changes or modifications could void the user's authority to operate this equipment.

Note: To assure compliance with FCC regulations on electromagnetic interference for a Class A computing device, use a properly shielded and grounded cable such as Lexmark part number 1021231 for parallel attach or 1021294 for USB attach. Use of a substitute cable not properly shielded and grounded may result in a violation of FCC regulations.

Any questions regarding this compliance information statement should be directed to:

Director of Lexmark Technology & Services
Lexmark International, Inc.
740 West New Circle Road
Lexington, KY 40550
Telephone: (859) 232-2000
E-mail: regulatory@lexmark.com

Innovation, Science and Economic Development Canada compliance statement

This Class A digital apparatus meets all requirements of the Canadian Interference-Causing Equipment Standard ICES-003.

Avis de conformité aux normes de l'Innovation, Sciences et Développement économique Canada

Cet appareil numérique de classe A est conforme aux exigences de la norme canadienne relative aux équipements pouvant causer des interférences NMB-003.

European Community (EC) directives conformity

This product is in conformity with the protection requirements of EC Council directives 2014/30/EU, 2014/35/EU, and 2011/65/EU as amended by (EU) 2015/863 on the approximation and harmonization of the laws of the Member States relating to electromagnetic compatibility, safety of electrical equipment designed for use within certain voltage limits, and on the restrictions of use of certain hazardous substances in electrical and electronic equipment.

The manufacturer of this product is: Lexmark International, Inc., 740 West New Circle Road, Lexington, KY, 40550 USA. The EEA/EU authorized representative is: Lexmark International Technology Hungária Kft., 8 Lechner Ödön fasor, Millennium Tower III, 1095 Budapest HUNGARY. The EEA/EU Importer is: Lexmark International Technology S.à.r.l. 20, Route de Pré-Bois, ICC Building, Bloc A, CH-1215 Genève, Switzerland. A declaration of conformity to the requirements of the Directives is available upon request from the Authorized Representative or may be obtained at

www.lexmark.com/en_us/about/regulatory-compliance/european-union-declaration-of-conformity.html.

This product satisfies the Class A limits of EN 55032 and safety requirements of EN 62368-1.

United Kingdom (UK) conformity

United Kingdom (UK) conformity

This product is in conformity with the protection requirements of the Electromagnetic Compatibility Regulations 2016, the Electrical Equipment (Safety) Regulations 2016, and the Restriction of the Use of Certain Hazardous Substances in Electrical and Electronic Equipment Regulations 2012.

The manufacturer of this product is: Lexmark International, Inc., 740 West New Circle Road, Lexington, KY, 40550 USA. The UK Importer is: Lexmark International Ltd, Quantum House, 60 Norden Road, Maidenhead SL6 4AY, United Kingdom. A declaration of conformity is available upon request from the UK Importer or may be obtained at www.lexmark.com/en_us/about/regulatory-compliance/uk-declaration-of-conformity.html.

This product satisfies the Class A limits of BS EN 55032 and safety requirements of BS EN 62368-1.

Radio interference notice

Warning

This is a product that complies with the emission requirements of EN 55032 Class A limits and immunity requirements of EN 55035. This product is not intended to be used in residential/domestic environments.

This is a Class A product. In a domestic environment, this product may cause radio interference, in which case the user may be required to take adequate measures.

STATEMENT OF LIMITED WARRANTY FOR LEXMARK LASER PRINTERS, LEXMARK LED PRINTERS, AND LEXMARK MULTIFUNCTION LASER PRINTERS

STATEMENT OF LIMITED WARRANTY FOR LEXMARK LASER PRINTERS, LEXMARK LED PRINTERS, AND LEXMARK MULTIFUNCTION LASER PRINTERS

Lexmark International, Inc., Lexington, KY

This limited warranty applies to the United States and Canada. For customers outside the U.S., refer to the country-specific warranty information that came with your product.

This limited warranty applies to this product only if it was originally purchased for your use, and not for resale, from Lexmark or a Lexmark Remarketer, referred to in this statement as “Remarketer.”

Limited warranty

Lexmark warrants that this product:

- Is manufactured from new parts, or new and serviceable used parts, which perform like new parts
- Is, during normal use, free from defects in material and workmanship

If this product does not function as warranted during the warranty period, contact a Remarketer or Lexmark for repair or replacement (at Lexmark's option).

If this product is a feature or option, this statement applies only when that feature or option is used with the product for which it was intended. To obtain warranty service, you may be required to present the feature or option with the product.

If you transfer this product to another user, warranty service under the terms of this statement is available to that user for the remainder of the warranty period. You should transfer proof of original purchase and this statement to that user.

Limited warranty service

The warranty period starts on the date of original purchase as shown on the purchase receipt and ends 12 months later provided that the warranty period for any supplies and for any maintenance items included with the printer shall end earlier if it, or its original contents, are substantially used up, depleted, or consumed. Fuser Units, Transfer/Transport Units, Paper Feed items, if any, and any other items for which a Maintenance Kit is available are substantially consumed when the printer displays a “Life Warning” or “Scheduled Maintenance” message for such item.

To obtain warranty service you may be required to present proof of original purchase. You may be required to deliver your product to the Remarketer or Lexmark, or ship it prepaid and suitably packaged to a Lexmark designated location. You are responsible for loss of, or damage to, a product in transit to the Remarketer or the Lexmark designated location.

When warranty service involves the exchange of a product or part, the item replaced becomes the property of the Remarketer or Lexmark. The replacement may be a new or repaired item.

The replacement item assumes the remaining warranty period of the original product.

Replacement is not available to you if the product you present for exchange is defaced, altered, in need of a repair not included in warranty service, damaged beyond repair, or if the product is not free of all legal obligations, restrictions, liens, and encumbrances.

As part of your warranty service and/or replacement, Lexmark may update the firmware in your printer to the latest version. Firmware updates may modify printer settings and cause counterfeit and/or unauthorized products, supplies, parts, materials (such as toners and inks), software, or interfaces to stop working. Authorized use of genuine Lexmark products will not be impacted.

Before you present this product for warranty service, remove all print cartridges, programs, data, and removable storage media (unless directed otherwise by Lexmark).

For further explanation of your warranty alternatives and the nearest Lexmark authorized servicer in your area contact Lexmark on the World Wide Web.

Remote technical support is provided for this product throughout its warranty period. For products no longer covered by a Lexmark warranty, technical support may not be available or only be available for a fee.

Extent of limited warranty

Lexmark does not warrant uninterrupted or error-free operation of any product or the durability or longevity of prints produced by any product.

Warranty service does not include repair of failures caused by:

- Modification or unauthorized attachments
- Accidents, misuse, abuse or use inconsistent with Lexmark user's guides, manuals, instructions or guidance
- Unsuitable physical or operating environment
- Maintenance by anyone other than Lexmark or a Lexmark authorized servicer
- Operation of a product beyond the limit of its duty cycle
- Use of printing media outside of Lexmark specifications
- Refurbishment, repair, refilling or remanufacture by a third party of products, supplies or parts
- Products, supplies, parts, materials (such as toners and inks), software, or interfaces not furnished by Lexmark

TO THE EXTENT PERMITTED BY APPLICABLE LAW, NEITHER LEXMARK NOR ITS THIRD PARTY SUPPLIERS OR REMARKETERS MAKE ANY OTHER WARRANTY OR CONDITION OF ANY KIND, WHETHER EXPRESS OR IMPLIED, WITH RESPECT TO THIS PRODUCT, AND SPECIFICALLY DISCLAIM THE IMPLIED WARRANTIES OR CONDITIONS OF MERCHANTABILITY, FITNESS FOR A PARTICULAR PURPOSE, AND SATISFACTORY QUALITY. ANY WARRANTIES THAT MAY NOT BE DISCLAIMED UNDER APPLICABLE LAW ARE LIMITED IN DURATION TO THE WARRANTY PERIOD. NO WARRANTIES, EXPRESS OR IMPLIED, WILL APPLY AFTER THIS PERIOD. ALL INFORMATION, SPECIFICATIONS, PRICES, AND SERVICES ARE SUBJECT TO CHANGE AT ANY TIME WITHOUT NOTICE.

Limitation of liability

Your sole remedy under this limited warranty is set forth in this document. For any claim concerning performance or nonperformance of Lexmark or a Remarketer for this product under this limited warranty, you may recover actual damages up to the limit set forth in the following paragraph.

Lexmark's liability for actual damages from any cause whatsoever will be limited to the amount you paid for the product that caused the damages. This limitation of liability will not apply to claims by you for bodily injury or damage to real property or tangible personal property for which Lexmark is legally liable. **IN NO EVENT WILL**

LEXMARK BE LIABLE FOR ANY LOST PROFITS, LOST SAVINGS, INCIDENTAL DAMAGE, OR OTHER ECONOMIC OR CONSEQUENTIAL DAMAGES. This is true even if you advise Lexmark or a Remarketer of the possibility of such damages. Lexmark is not liable for any claim by you based on a third party claim.

This limitation of remedies also applies to claims against any Suppliers and Remarketers of Lexmark. Lexmark's and its Suppliers' and Remarketers' limitations of remedies are not cumulative. Such Suppliers and Remarketers are intended beneficiaries of this limitation.

Additional rights

Some states do not allow limitations on how long an implied warranty lasts, or do not allow the exclusion or limitation of incidental or consequential damages, so the limitations or exclusions contained above may not apply to you.

This limited warranty gives you specific legal rights. You may also have other rights that vary from state to state.

Index

A

- activating Voice Guidance 28
- adapter plug 38
- adding a shortcut
 - copy 111
- adding apps to home screen 23
- adding contact groups 27
- adding contacts 27
- adding hardware options
 - print driver 56
- adding internal options
 - print driver 56
- adding printers to a computer 55
- adding shortcut
 - e-mail 112
 - fax destination 114
 - FTP address 118
- Address Book
 - using 27
- ADF pick roller
 - cleaning 256
 - replacing 244
- ADF registration
 - adjusting 338
- ADF rollers
 - cleaning 256
 - replacing 244
- ADF separator roller
 - cleaning 256
 - replacing 244
- adjusting
 - scanner registration 338
- adjusting ADF registration 338
- adjusting brightness
 - of display 261
- adjusting default volume
 - headphone 33
 - speaker 33
- adjusting fax darkness 114
- adjusting speech rate
 - Voice Guidance 33
- adjusting toner darkness 108
- AirPrint
 - using 104
- analog fax
 - setting up 34
- answering machine
 - setting up 36

- assigning printer to a ring
 - pattern 40
- attaching cables 21
- avoiding paper jams 306

B

- black images 287
- black imaging unit
 - ordering 210
 - replacing 214
- blank pages 273
- blocking junk faxes 115
- bookmarks
 - creating 26
 - creating folders for 27

C

- caller ID is not shown 326
- canceling a print job 108
- cannot connect printer to
 - Wi-Fi 317
- cannot open Embedded Web
 - Server 316
- cannot receive faxes using
 - analog fax 329
- cannot scan to a computer 332
- cannot scan to a network
 - folder 333
- cannot send e-mails 326
- cannot send or receive faxes
 - using analog fax 327
- cannot send or receive faxes
 - using etherFAX 330
- cannot send the fax cover page
 - from the computer 331
- Card Copy
 - setting up 24
- card stock
 - loading 52
- cards
 - copying 111
- changing fax resolution 114
- changing the printer port settings
 - after installing ISP 77
- changing the wallpaper 25
- checking the status of parts and
 - supplies 207
- cleaning
 - exterior of the printer 249
 - interior of the printer 249
 - pick tires 252
- cleaning pick roller in the
 - multipurpose feeder 254
- cleaning the ADF pick roller 256
- cleaning the ADF rollers 256
- cleaning the ADF separator
 - roller 256
- cleaning the printer 249
- Cleaning the Scanner 206
- cleaning the scanner 250
- cleaning the touch screen 249
- clearing jam
 - behind door A 311
 - in automatic document
 - feeder 310
 - in the duplex area 311
 - in the fuser area 311
 - in the multipurpose feeder 310
 - in the standard bin 311
 - in trays 309
- collated printing does not
 - work 323
- collating copies 110
- color correction 339
- color imaging kit
 - ordering 210
 - replacing 223
- color quality, troubleshooting
 - print appears tinted 341
- colored background on print 278
- computer
 - connecting to the printer 99
 - computer, scanning to 117
 - confidential documents do not
 - print 301
 - confidential print jobs
 - configuring 106
 - printing 107
 - configuring daylight saving
 - time 40
 - configuring fax speaker
 - settings 40
 - configuring supply
 - notifications 207

- configuring the e-mail server settings 40
- configuring Wi-Fi Direct 98
- connecting a computer to the printer 99
- connecting mobile device to printer 99
- connecting printer to distinctive ring service 40
- connecting the printer to a wireless network 97
- connecting to a wireless network using PIN method 97
- connecting to a wireless network using Push Button method 97
- conserving supplies 261
- contacting customer support 341
- control panel using 11
- convenience stapler installing 81
- red indicator light 321
- copy troubleshooting
 - partial copies of documents or photos 334
 - poor copy quality 335
 - scanner does not respond 338
- copying
 - cards 111
 - on both sides of the paper 110
 - on letterhead 110
 - photos 109
 - using the automatic document feeder (ADF) 109
 - using the scanner glass 109
- copying different paper sizes 109
- copying from selected tray 109
- copying multiple pages onto a single sheet 111
- creating a shortcut copy 111
- network folder 119
- creating bookmarks 26
- creating folders for bookmarks 27
- creating shortcut e-mail 112
- fax destination 114
- FTP address 118
- creating shortcuts 24
- crooked print 286

- Customer Support using 25
- customer support contacting 341
- customizing the display 25

D

- dark print 275
- date and time fax settings 40
- daylight saving time configuring 40
- deactivating the Wi-Fi network 100
- deactivating Voice Guidance 28
- default headphone volume adjusting 33
- default speaker volume adjusting 33
- defective intelligent storage drive 320
- deleting contact groups 27
- deleting contacts 27
- Device Quotas setting up 26
- different paper sizes, copying 109
- directory list printing 108
- display brightness adjusting 261
- Display Customization using 25
- displaying apps on home screen 23
- distinctive ring service, fax enabling 40
- documents, printing from a computer 103
- from a mobile device 103
- dots on printed page 284

E

- editing contacts 27
- emission notices 344, 0
- enabling Magnification mode 32
- enabling personal identification numbers 33
- enabling spoken passwords 33
- enabling the USB port 306
- enabling Wi-Fi Direct 99

- enlarging a copy size 110
- envelope seals when printing 323
- envelopes loading 52
- environmental settings 261
- erasing printer memory 101, 102
- erasing printer storage drive 101
- error codes 264
- error message SMTP server not set up 325
- error messages 264
- etherFAX setting up fax function 35
- Ethernet cable 21
- Ethernet port 21
- exporting a configuration file using the Embedded Web Server 56
- e-mail sending 112
- e-mail alerts setting up 207
- e-mail function setting up 40
- e-mail server configuring 40
- e-mail service providers 40
- e-mail shortcut creating 112
- e-mail troubleshooting cannot send e-mails 326
- e-mailing using the automatic document feeder (ADF) 112
- using the scanner glass 112

F

- factory default settings restoring 102
- FAQ about color printing 340
- fax forwarding 115
- holding 115
- sending 113
- fax card installing 67
- fax darkness adjusting 114
- fax destination shortcut creating 114

- fax driver
 - installing 55
 - fax log
 - printing 115
 - fax resolution
 - changing 114
 - fax server, using
 - setting up the fax function 36
 - fax setup
 - country- or region-specific 38
 - standard telephone line connection 36
 - fax speaker settings
 - configuring 40
 - fax troubleshooting
 - caller ID is not shown 326
 - can send but not receive faxes
 - using analog fax 329
 - cannot send faxes using analog fax 329
 - cannot send or receive faxes
 - using analog fax 327
 - cannot send or receive faxes
 - using etherFAX 330
 - cannot send the fax cover page
 - from the computer 331
 - cannot set up etherFAX 329
 - missing information on the fax cover page 331
 - poor print quality 331
 - fax, scheduling 114
 - faxing
 - setting the date and time 40
 - using the automatic document feeder (ADF) 113
 - using the scanner glass 113
 - file types
 - supported 106
 - finding printer information 9
 - finding the printer serial number 10
 - firmware, updating
 - using the control panel 57
 - using the Embedded Web Server 58
 - flash drive
 - printing from 105
 - scanning to 120
 - flash drives
 - supported 106
 - font sample list
 - printing 108
 - forwarding fax 115
 - FTP address
 - creating shortcut 118
 - FTP server, scanning to
 - using the control panel 118
 - fuser
 - replacing 234
 - fuser maintenance kit
 - ordering 210
 - G**
 - genuine Lexmark parts and supplies 208
 - genuine parts and supplies 208
 - ghost images 277
 - gray background on print 278
 - H**
 - hard disk
 - erasing 101
 - hard disk storage drive 102
 - hardware options
 - trays 59
 - hardware options, adding
 - print driver 56
 - held documents do not print 301
 - held jobs
 - printing 107
 - setting expiration time 106
 - Hibernate mode
 - configuring 261
 - holding faxes 115
 - home screen
 - customizing 23
 - using 22
 - home screen icons
 - displaying 23
 - horizontal dark lines 292
 - horizontal white lines 294
 - humidity around the printer 348
 - I**
 - icons on the home screen
 - showing 23
 - images cut off on print 288
 - importing a configuration file
 - using the Embedded Web Server 56
 - incorrect margins 279
 - indicator light
 - understanding the status 12
 - installing internal options
 - fax card 67
 - intelligent storage drive 60
 - Trusted Platform Module 64
 - installing options
 - internal solutions port 72
 - printer hard disk 78
 - installing the convenience stapler 81
 - installing the fax driver 55
 - installing the print driver 54
 - installing the printer software 54
 - installing trays 59
 - installing wireless print server 87, 93, 95
 - intelligent storage drive 58, 102
 - erasing 101
 - installing 60
 - internal option is not detected 318
 - internal options 58
 - internal options, adding
 - print driver 56
 - internal solutions port 58
 - installing 72
 - troubleshooting 319
- J**
 - jagged image
 - scanning from the ADF 336
 - jagged text
 - scanning from the ADF 336
 - jam areas
 - locating 307
 - jam, clearing
 - in the multipurpose feeder 310
 - in the standard bin 311
 - jammed pages are not reprinted 325
 - jams, paper
 - avoiding 306
 - job prints from the wrong tray 302
 - job prints on the wrong paper 302
 - junk faxes
 - blocking 115
- L**
 - letterhead
 - copying on 110

- selecting 14
- Lexmark Mobile Print
 - using 103
- Lexmark Print
 - using 103
- Lexmark ScanBack Utility
 - using 117
- light print 279
- linking trays 54
- loading
 - card stock 52
 - envelopes 52
 - multipurpose feeder 52
- loading trays 49
- locating jam areas 307
- locating the security slot 101

M

- Magnification mode
 - enabling 32
- maintenance counter
 - resetting 248
- making copies 109
- managing screen saver 25
- manual color correction 339
- MarkNet N8370 Wireless Print Server 87
- MarkNet N8372 Wireless Print Server 93
- MarkNet N8450 Wireless Print Server 95
- menu
 - 802.1x 192
 - About this Printer 137
 - Accessibility 129
 - Anonymous Data
 - Collection 129
 - Cloud Services Enrollment 204
 - Confidential Print Setup 201
 - Configuration Menu 131
 - Copy Defaults 149
 - Custom Scan Sizes 148
 - Default Login Methods 198
 - Device 204
 - Disk Encryption 202
 - Eco-Mode 123
 - Erase Temporary Data
 - Files 202
 - Ethernet 187
 - E-mail Defaults 169
 - E-mail Setup 168
 - Fax 205

- Fax Mode 152
- Fax Server Setup 164
- Fax Setup 153
- Flash Drive Print 181
- Flash Drive Scan 178
- FTP Defaults 174
- Home Screen
 - Customization 136
- HTTP/FTP Settings 194
- Image 146
- IPSec 191
- Job Accounting 142
- Layout 138
- Local Accounts 197
- Login Restrictions 201
- LPD Configuration 193
- Manage Permissions 196
- Media Types 148
- Menu Settings Page 204
- Miscellaneous 203
- Mobile Services
 - Management 187
- Network 206
- Network Overview 183
- Notifications 125
- Out of Service Erase 136
- PCL 144
- PDF 143
- PostScript 143
- Power Management 128
- Preferences 122
- Print 205
- Quality 140
- Remote Operator Panel 124
- Restore Factory Defaults 130
- Restrict external network
 - access 195
- Schedule USB Devices 198
- Security Audit Log 199
- Setup 139
- Shortcuts 205
- SNMP 190
- Solutions LDAP Settings 203
- TCP/IP 188
- ThinPrint 194
- Tray Configuration 146
- Troubleshooting 206
- Universal Setup 147
- Update firmware 137
- USB 195
- Web Link Setup 174
- Wireless 184

- Wi-Fi Direct 186
- Menu Settings Page
 - printing 206
- missing colors 282
- missing information on the fax cover page 331
- mobile device
 - connecting to printer 99
 - printing from 103, 104
- modifying color output 339
- Mopria Print Service 104
- mottled print and dots 284
- moving the printer 20, 261
- Multiple Universal Sizes
 - enabling 49
- multipurpose feeder
 - loading 52

N

- navigating the screen
 - using gestures 28
- network folder
 - creating a shortcut 119
- network setup page
 - printing 100
- noise emission levels 344
- nonvolatile memory
 - erasing 101
- Non-Lexmark supply 322
- non-volatile memory 102
- Not enough free space in flash memory for resources 320
- notices 344, 347, 349, 350, 0

O

- on-screen keyboard
 - using 32
- ordering supplies
 - black imaging unit 210
 - color imaging kit 210
 - fuser maintenance kit 210
 - toner cartridge 208
 - waste toner bottle 210

P

- paper
 - letterhead 14
 - preprinted forms 14
 - selecting 12
 - unacceptable 13
 - Universal size setting 48

- paper characteristics 12
- paper frequently jams 324
- paper guidelines 12
- paper jam
 - behind door A 311
 - in automatic document feeder 310
 - in the duplex area 311
 - in the fuser area 311
 - in the multipurpose feeder 310
 - in the standard bin 311
 - in trays 309
- paper jams
 - avoiding 306
- paper size
 - setting 48
- paper sizes
 - supported 15
- paper type
 - setting 48
- paper types
 - supported 18
- paper weights
 - supported 19
- parallel interface card
 - troubleshooting 320
- parts status
 - checking 207
- personal identification numbers
 - enabling 33
- photos, copying 109
- pick roller
 - replacing 236
- pick roller in the multipurpose feeder
 - cleaning 254
- pick tires
 - cleaning 252
- placing separator sheets 108
- placing separator sheets between copies
 - copying 110
- poor fax print quality 331
- power cord socket 21
- power save modes
 - configuring 261
- preprinted forms
 - selecting 14
- print appears tinted 341
- print driver
 - hardware options, adding 56
 - installing 54
- print job
 - canceling 108
- print jobs not printed 300
- print quality problem
 - blank pages 273
 - images cut off on print 288
 - light print 279
 - missing colors 282
 - repeating print defects 297
 - text cut off on print 288
 - white pages 273
- Print Quality Test Pages 206
- print quality troubleshooting
 - crooked print 286
 - dark print 275
 - ghost images appear on prints 277
 - gray or colored background 278
 - horizontal dark lines 292
 - horizontal white lines 294
 - mottled print and dots 284
 - paper curl 285
 - skewed print 286
 - solid color or black images 287
 - toner easily rubs off 290
 - uneven print density 291
 - vertical dark lines appear on prints 293
 - vertical white lines 295
- print troubleshooting
 - collated printing does not work 323
 - confidential and other held documents do not print 301
 - envelope seals when printing 323
 - incorrect margins 279
 - job prints from the wrong tray 302
 - job prints on the wrong paper 302
 - paper frequently jams 324
 - print jobs do not print 300
 - slow printing 302
 - tray linking does not work 324
 - unable to read flash drive 305
- printer
 - minimum clearances 20
 - selecting a location for 20
 - shipping 262
- printer configurations 10
- printer error codes 264
- printer error messages 264
- printer hard disk 58
 - installing 78
- printer information
 - finding 9
- printer is not responding 304
- printer memory
 - erasing 101
- printer menus 121, 206
- printer messages
 - Defective flash detected 320
 - Non-Lexmark supply 322
 - Not enough free space in flash memory for resources 320
 - Replace cartridge, printer region mismatch 321
- printer options troubleshooting
 - cannot detect internal option 318
 - internal solutions port 319
 - parallel interface card 320
 - serial interface card 320
- printer port settings
 - changing 77
- printer ports 21
- printer settings
 - restoring factory default 102
- printer software
 - installing 54
- printer status 12
- printing
 - confidential print jobs 107
 - directory list 108
 - font sample list 108
 - from a computer 103
 - from a flash drive 105
 - from a mobile device 104
 - held jobs 107
 - Menu Settings Page 206
 - network setup page 100
 - using Mopria Print Service 104
 - using Wi-Fi Direct 104
- printing a directory list 108
- printing a fax log 115
- printing a font sample list 108
- printing a network setup page 100
- printing from a computer 103

R

- received faxes
 - holding 115
- recycling
 - Lexmark packaging 342
 - Lexmark products 342
- red indicator light
 - on the convenience stapler 321
- reducing a copy size 110
- removing jam
 - behind door A 311
 - in the duplex area 311
 - in the fuser area 311
- removing paper jam
 - in automatic document feeder 310
 - in trays 309
- repeat print jobs 106
- repeating print defects 297
- Replace cartridge, printer region mismatch 321
- replacing parts
 - ADF pick roller 244
 - ADF rollers 244
 - ADF separator roller 244
 - fuser 234
 - pick roller 236
 - separator bracket 240
- replacing supplies
 - black imaging unit 214
 - color imaging kit 223
 - scanner glass pad 242
 - toner cartridge 211
 - waste toner bottle 232
- reports
 - printer status 208
 - printer usage 208
- resetting
 - supply usage counters 322
- resetting supply usage counters 249
- resetting the maintenance counter 248
- resetting the supply usage counters 322
- RJ-11 adapter 38
- running a slideshow 25

S

- safety information 7, 8
- saving paper 111

- saving toner 111
- Scan Center
 - setting up 24
- scan troubleshooting
 - cannot scan to a computer 332
 - cannot scan to network folder 333
 - jagged image when scanning from the ADF 336
 - jagged text when scanning from the ADF 336
 - partial copies of documents or photos 334
 - poor copy quality 335
 - scan job was not successful 337
 - scanner does not respond 338
 - scanning freezes the computer 337
 - scanning takes too long 337
 - vertical dark streaks on output when scanning from the ADF 335
- scanner
 - cleaning 250
- scanner does not close 337
- scanner glass pad
 - replacing 242
- scanning
 - to a computer 117
 - to an FTP server 118
 - to flash drive 120
 - using the automatic document feeder (ADF) 117
 - using the scanner glass 117
- scanning from ADF
 - jagged image 336
 - jagged text 336
- scanning quality problem 335
- scanning to a network folder 119
- scanning to an FTP server
 - using the control panel 118
- scheduling a fax 114
- screen gestures 28
- securing printer data 102
- security slot
 - locating 101
- selecting location
 - for the printer 20
- sending e-mail 112
- sending fax 113
- separator bracket
 - replacing 240
- separator sheets
 - placing 108
- serial interface card
 - troubleshooting 320
- serial number, printer
 - finding 10
- serial printing
 - setting up 100
- setting paper size
 - Multiple Universal Sizes 49
- setting the paper size 48
- setting the paper type 48
- setting the Universal paper size 48
- setting up
 - analog fax 34
 - setting up Device Quotas 26
 - setting up e-mail alerts 207
 - setting up fax
 - country- or region-specific 38
 - standard telephone line connection 36
 - setting up fax function
 - using etherFAX 35
 - setting up serial printing 100
 - setting up the fax function using fax server 36
- shipping the printer 262
- shortcut
 - Copy 24
 - Email 24
 - Fax 24
 - FTP 24
- shortcut, creating
 - e-mail 112
 - fax destination 114
 - FTP address 118
- shortcut, creating a copy 111
- shortcuts
 - creating 24
- skewed print 286
- Sleep mode
 - configuring 261
- slow printing 302
- SMB
 - scanning 119
- SMTP server not set up 325
- SMTP settings
 - configuring 40

- solid color 287
- sorting multiple copies 110
- spoken passwords
 - enabling 33
- statement of volatility 102
- storage drive
 - erasing 101
- storing paper 14
- storing print jobs 106
- supplies
 - conserving 261
- supplies status
 - checking 207
- supply notifications
 - configuring 207
- supply usage counters
 - resetting 249, 322
- supported applications 23
- supported fax 33
- supported file types 106
- supported flash drives 106
- supported paper sizes 15
- supported paper types 18
- supported paper weights 19

T

- temperature around the printer 348
- text cut off on print 288
- toner cartridge
 - ordering 208
 - replacing 211
- toner darkness
 - adjusting 108
- toner easily rubs off 290
- touch screen
 - cleaning 249
- touch-screen gestures 28
- trays
 - installing 59
 - linking 54
 - loading 49
 - unlinking 54
- troubleshooting
 - cannot connect printer to Wi-Fi 317
 - cannot open Embedded Web Server 316
 - FAQ about color printing 340
 - printer is not responding 304
 - SMTP server not set up 325

- troubleshooting, color quality
 - print appears tinted 341
- troubleshooting, copy
 - partial copies of documents or photos 334
 - poor copy quality 335
 - scanner does not close 337
 - scanner does not respond 338
- troubleshooting, e-mail
 - cannot send e-mails 326
- troubleshooting, fax
 - caller ID is not shown 326
 - can send but not receive faxes
 - using analog fax 329
 - cannot send faxes using analog fax 329
 - cannot send or receive faxes
 - using analog fax 327
 - cannot send or receive faxes
 - using etherFAX 330
 - cannot send the fax cover page from the computer 331
 - cannot set up etherFAX 329
 - missing information on the fax cover page 331
 - poor print quality 331
- troubleshooting, print
 - collated printing does not work 323
 - confidential and other held documents do not print 301
 - envelope seals when printing 323
 - incorrect margins 279
 - jammed pages are not reprinted 325
 - job prints from the wrong tray 302
 - job prints on the wrong paper 302
 - paper frequently jams 324
 - print jobs do not print 300
 - slow printing 302
 - tray linking does not work 324
- troubleshooting, print quality
 - crooked print 286
 - dark print 275
 - ghost images appear on prints 277
 - gray or colored
 - background 278
 - horizontal dark lines 292

- horizontal white lines 294
- mottled print and dots 284
- paper curl 285
- skewed print 286
- solid color or black images 287
- toner easily rubs off 290
- uneven print density 291
- vertical dark lines appear on prints 293
- vertical white lines 295
- troubleshooting, printer options
 - cannot detect internal option 318
 - internal solutions port 319
- troubleshooting, scan
 - cannot scan to a computer 332
 - cannot scan to a network folder 333
 - jagged image when scanning from the ADF 336
 - jagged text when scanning from the ADF 336
 - partial copies of documents or photos 334
 - poor copy quality 335
 - scan job was not successful 337
 - scanner does not close 337
 - scanner does not respond 338
 - vertical dark streaks on output when scanning from the ADF 335
- Trusted Platform Module
 - installing 64
- two-sided copying 110

U

- unable to read flash drive
 - troubleshooting, print 305
- uneven print density 291
- Universal paper size
 - setting 48
- unlinking trays 54
- updating firmware
 - using the control panel 57
 - using the Embedded Web Server 58
- USB cable 21
- USB port 21
 - enabling 306
- using Customer Support 25
- using Display Customization 25

using genuine Lexmark parts and supplies 208
using the ADF
 copying 109
using the control panel 11
using the home screen 22
using the scanner glass
 copying 109

V

verify print jobs 106
vertical dark lines on prints 293
vertical dark streaks on output
when scanning from the
ADF 335
vertical white lines 295
viewing reports 208
Voice Guidance
 activating 28
 deactivating 28
 speech rate 33
Voice Guidance speech rate
 adjusting 33
volatile memory 102
 erasing 101

W

waste toner bottle
 ordering 210
 replacing 232
white pages 273
wireless network
 connecting the printer to 97
wireless networking 97
wireless print server 58
 installing 87, 93, 95
Wi-Fi Direct
 configuring 98
 enabling 99
 printing from a mobile
 device 104
Wi-Fi network
 deactivating 100
Wi-Fi Protected Setup
 configuring 97