



# Refrigerator

## User manual

RT18M\*/RT21M\*

Free Standing Appliance

**SAMSUNG**

# Contents

---

<b>Safety information</b>	<b>3</b>
Important safety symbols and precautions:	4
State of California Proposition 65 Warning (US only)	4
Severe warning signs for transportation and site	4
Critical installation warnings	5
Installation cautions	7
Critical usage warnings	7
Usage cautions	10
Cleaning cautions	11
Critical disposal warnings	12
Additional tips for proper usage	13
<b>Installation</b>	<b>14</b>
Refrigerator at a glance	14
Step-by-step installation	15
<b>Operations</b>	<b>28</b>
Feature panel	28
Special features	33
<b>Maintenance</b>	<b>35</b>
Door reversal (applicable models only)	35
Handle and care	50
Cleaning	52
Replacement	52
<b>Troubleshooting</b>	<b>53</b>
General	53
Do you hear abnormal sounds from the refrigerator?	56
<b>Warranty (USA)</b>	<b>58</b>
WARRANTY ON SAMSUNG REFRIGERATOR	58
<b>Warranty Information (CANADA)</b>	<b>60</b>
If your refrigerator needs service	60
Limited Warranty for Original Purchaser	60
Obligation to the Original Owner	60
Exclusions of the Warranty	60

# Safety information

- Before using your new Samsung Refrigerator, please read this manual thoroughly to ensure that you know how to operate the features and functions that your new appliance offers safely and efficiently.
- This appliance is not intended for use by persons (including children) with reduced physical, sensory, or mental capabilities, or those who lack experience and knowledge, unless they have been given supervision or instruction concerning the use of the appliance by a person responsible for their safety.
- This appliance can be used by children aged 8 years and above and persons with reduced physical, sensory or mental capabilities or lack of experience and knowledge if they have been given supervision or instruction concerning use of the appliance in a safe way and understand the hazards involved. Do not let children play with the refrigerator. Do not let children clean the refrigerator or perform user maintenance on the refrigerator without supervision.
- Warnings and Important Safety Instructions in this manual do not cover all possible conditions and situations that may occur.  
It is your responsibility to use common sense, caution, and care when installing, maintaining, and operating your appliance.
- Because the following operating instructions cover various models, the characteristics of your refrigerator may differ slightly from those described in this manual. Not all warning signs may be applicable. If you have any questions or concerns, contact your nearest Samsung service center or find help and information online at [www.samsung.com](http://www.samsung.com).
- Refrigerant squirting out of the pipes could ignite or cause an eye injury. When refrigerant leaks from the pipe, avoid any naked flames and move anything flammable away from the product and ventilate the room immediately.
  - Failing to do so may result in fire or explosion.
- It is hazardous for anyone other than an Authorised Service Person to service this appliance.

## WARNING

- R-600a is used as a refrigerant. This product contains flammable gas (Refrigerant R-600a), contact your local authority in regard to safe disposal of this product.
- In order to avoid the creation of a flammable gas-air mixture if a leak in the refrigerating circuit occurs, the size of the room in which the appliance may be sited depends on the amount of refrigerant used. The room must be 35.3 ft<sup>3</sup> in size for every 8 g of R-600a refrigerant inside the appliance.
- The installation location should not be exposed to direct sunlight and not placed near any electric appliance or heat source, e.g. stove, oven or hob, radiator, etc.
- If you use two products side by side, for safety reason, be sure to use certified products in explosive gas atmospheres.
- Never start up an appliance showing any signs of damage. If in doubt, consult your dealer.

# Safety information

---

## Important safety symbols and precautions:

---

### **WARNING**

Hazards or unsafe practices that may result in **severe personal injury or death**.

### **CAUTION**

Hazards or unsafe practices that may result in **minor personal injury or property damage**.

These warning signs are here to prevent injury to you and others.

Please follow them carefully.

After reading this section, keep it in a safe place for future reference.

## State of California Proposition 65 Warning (US only)

---

**WARNING** : This product contains chemicals known to the State of California to cause cancer and birth defects or other reproductive harm.

## Severe warning signs for transportation and site

---

### **WARNING**

- When transporting and installing the appliance, care should be taken to ensure that no parts of the refrigerating circuit are damaged.
  - Refrigerant leaking from the pipe work could ignite or cause an eye injury. If a leak is detected, avoid any naked flames or potential sources of ignition and air the room in which the appliance is standing for several minutes.
  - This appliance contains a small amount of isobutane refrigerant (R-600a), a natural gas with high environmental compatibility that is, however, also flammable. When transporting and installing the appliance, care should be taken to ensure that no parts of the refrigerating circuit are damaged.



---

## Critical installation warnings

---

### **WARNING**

- Do not install the refrigerator in a damp location or place where it may come in contact with water.
  - Deteriorated insulation on electrical parts may cause an electric shock or fire.
- Do not place this refrigerator in direct sunlight or expose it to the heat from stoves, room heaters, or other appliances.
- Do not plug several appliances into the same multiple power strip. The refrigerator should always be plugged into its own individual electrical outlet which has a voltage rating that matches the voltage listed on the refrigerator's rating plate.
  - This provides the best performance and also prevents overloading of house wiring circuits, which could cause a fire hazard from overheated wires.
- If the wall socket is loose, do not insert the power plug.
  - There is a risk of electric shock or fire.
- Do not use a power cord that has cracks or abrasion damage along its length or at either end.
- Do not bend the power cord excessively or place heavy objects on it.
- Do not pull or excessively bend the power cord.
- Do not twist or tie the power cord.
- Do not hook the power cord over a metal object, place a heavy object on the power cord, insert the power cord between objects, or push the power cord into the space behind the appliance.
- When moving the refrigerator, be careful not to roll over or damage the power cord.
  - This may result in an electric shock or fire.
- Never unplug your refrigerator by pulling on the power cord. Always grip the plug firmly and pull straight out from the outlet.
  - Damage to the cord may cause a short-circuit, fire, and/or electric shock.
- Do not store explosive substances such as aerosol cans with a flammable propellant in this appliance.
- Do not install this appliance near a heater or flammable material.
- Do not install this appliance in a location where gas may leak.
  - This may result in an electric shock or fire.
- This refrigerator must be properly located and installed in accordance with the instructions in this manual before you use it.
- Connect the power plug in the proper position with the cord hanging down.
  - If you connect the power plug upside down, the wire can get cut off and cause a fire or electric shock.
- Make sure that the power plug is not crushed or damaged by the back of the refrigerator.
- Keep the packing materials out of reach of children.
  - There is a risk of death from suffocation if a child puts the packing materials on his or her head.
- The appliance must be positioned so that the plug is accessible after installation.
  - Failing to do so may result in an electric shock or fire due to electric leakage.





# Safety information

---

- Do not install this appliance in a humid, oily or dusty location, in a location exposed to direct sunlight and water (rain drops).
  - Deteriorated insulation of electrical parts may cause an electric shock or fire.
- If any dust or water is in the refrigerator, pull out power plug and contact a Samsung Electronics service center.
  - Otherwise there is a risk of fire.
- Do not stand on top of the appliance or place objects (such as laundry, lighted candles, lighted cigarettes, dishes, chemicals, metal objects, etc.) on the appliance.
  - This may result in an electric shock, fire, problems with the product, or injury.
- You need to remove all the protective plastic film before you initially plug the product in.
- Children should be supervised to ensure that they do not play with the snap rings used for door adjustment or the water tube clips.
  - There is risk of death by suffocation if a child swallows a snap ring or water tube clip. Keep the snap rings and water tube clips out of children's reach.
- The refrigerator must be safely grounded.
  - Always make sure that you have grounded the refrigerator before attempting to investigate or repair any part of the appliance. Power leakages can cause severe electric shock.
- Never use gas pipes, telephone lines, or other potential lightning attractors as an electrical ground.
  - You must ground the refrigerator to prevent any power leakages or electric shocks caused by current leakage from the refrigerator.
  - Grounding the refrigerator improperly may result in an electric shock, fire, explosion, or problems with the product.
  - Improper use of the grounding plug can result in a risk of electric shock. If it is necessary to use an extension cord, use only a 3-wire extension cord that has a 3-blade grounding plug and a 3-slot receptacle that will accept the plug on the appliance. The marked rating of the extension cord should be AC 115-120 V, 10 A, or more. If a grounding adapter is used, make sure the receptacle box is fully grounded.
- Plug the power plug into the wall socket firmly. Do not use a damaged power plug, damaged power cord, or loose wall socket.
  - This may result in an electric shock or fire.
- If the power cord is damaged, have it replaced immediately by the manufacturer or one of its service agents.
- The fuse on the refrigerator must be changed by a qualified technician or service company.
  - Failing to do so may result in an electric shock or personal injury.



---

## Installation cautions

---

### CAUTION

- Allow sufficient space around the refrigerator and install it on a flat surface.
  - Keep the ventilation space in the appliance enclosure or mounting structure clear of obstructions.
- After the refrigerator has been installed and turned on, let it stand for 2 hours before loading it with food.
- It is strongly recommended you have a qualified technician or service company install the refrigerator.
  - Failing to do so may result in an electric shock, fire, explosion, problems with the product, or injury.
- Overloading the refrigerator door may cause the refrigerator to fall, causing physical injury.

## Critical usage warnings

---

### WARNING

- Do not insert the power plug into a wall socket with wet hands.
  - This may result in an electric shock.
- Do not store articles on the top of the appliance.
  - When you open or close the door, the articles may fall and cause personal injury and/or material damage.
- Do not insert hands, feet, or metal objects (such as chopsticks, etc.) into the bottom or into the back of the refrigerator.
  - This may result in an electric shock or injury.
  - Any sharp edges may cause a personal injury.
- Do not touch the inside walls of the freezer or products stored in the freezer with wet hands.
  - This may cause frostbite.
- Do not put a container filled with water on the refrigerator.
  - If spilled, there is a risk of fire or electric shock.
- Do not keep volatile or flammable objects or substances (benzene, thinner, propane gas, alcohol, ether, LP gas, and other such products) in the refrigerator.
  - This refrigerator is for storing food only.
  - This may result in fire or explosion.
- Children should be supervised to ensure that they do not play with the appliance.
  - Keep fingers out of "pinch point" areas. Clearances between the doors and cabinet are necessarily small. Be careful when you open the doors if children are in the area.
- Do not let children hang on the door or door bins. A serious injury may occur.
- Do not let children go inside the refrigerator. They could become trapped.
- Do not store pharmaceutical products, scientific materials, or temperature sensitive products in the refrigerator.
  - Products that require strict temperature controls must not be stored in the refrigerator.

# Safety information

---

- Do not place or use electrical appliances inside the refrigerator/freezer, unless they are of a type recommended by the manufacturer.
- If you smell a burning smell or smoke, pull out power plug immediately and contact a Samsung Electronics service center.
- If any dust or water is in Refrigerator, pull out power plug and contact your nearest Samsung Electronics service center.
  - Otherwise there is a risk of fire.
- Do not let children step on a drawer.
  - The drawer may break and cause them to slip.
- Do not leave the doors of the refrigerator open while the refrigerator is unattended and do not let children enter inside the refrigerator.
- Do not allow babies or children go inside a drawer.
  - It can cause death from suffocation by entrapment or personal injury.
- Do not overfill the refrigerator with food.
  - When you open the door, an item may fall out and cause personal injury or material damage.
- Do not spray volatile material such as insecticide onto the surface of the appliance.
  - As well as being harmful to humans, it may also result in an electric shock, fire, or problems with the product.
- Do not use or place any substances sensitive to temperature such as flammable sprays, flammable objects, dry ice, medicine, or chemicals near or inside of the refrigerator.
- Do not use a hair dryer to dry the inside of the refrigerator. Do not place a lighted candle in the refrigerator for removing bad odours.
  - This may result in an electric shock or fire.
- Fill the water tank, ice tray and water cubes with potable water only (tap water, mineral water, or purified water).
  - Do not fill the tank with tea, juice or sports drinks. This may damage the refrigerator.
- Do not stand on top of the appliance or place objects (such as laundry, lighted candles, lighted cigarettes, dishes, chemicals, metal objects, etc.) on the appliance. This may result in an electric shock, fire, problems with the product, or injury. Do not put a container filled with water on the appliance.
  - If spilled, there is a risk of fire or electric shock.
- Do not use mechanical devices or any other means to accelerate the defrosting process, other than those recommended by the manufacturer.
- Do not damage the refrigerant circuit.
- Never stare directly at the UV LED lamp for long periods of time.
  - This may result in eye strain due to the ultraviolet rays.
- Do not put fridge shelves in upside down. The shelf stopper, which prevents the shelf from falling, will not work.
  - The shelf could fall and cause a personal injury.
- Keep fingers out of "pinch point" areas. Clearances between the doors and cabinet are necessarily small. Be careful when you open the doors if children are in the area.
- If a gas leak is detected, avoid any naked flames or potential sources of ignition, and air the room in which the appliance is standing for several minutes.
  - Do not touch the appliance or power cord.
  - Do not use a ventilating fan.
  - A spark may result in explosion or fire.
- Use only the LED Lamps provided by the manufacturer or its service agents.

- 
- Bottles should be stored tightly together so that they do not fall out.
  - This product is intended only for the storage of food in a domestic environment.
  - Do not attempt to repair, disassemble, or modify the refrigerator yourself.
    - Unauthorized modifications can cause safety problems. To reverse an unauthorized modification, we will charge the full cost of parts and labor.
  - Do not use any fuse (such as cooper, steel wire, etc.) other than a standard fuse.
  - If your refrigerator needs to be repaired or reinstalled, contact your nearest Samsung service center.
    - Failing to do so may result in an electric shock, fire, problems with the product, or injury.
  - If the interior or exterior LED lamp has gone out, contact your nearest Samsung service center.
  - If the refrigerator emits a burning smell or smoke, unplug the refrigerator immediately and contact your Samsung Electronics service center.
    - Failing to do so may result in an electric or fire hazard.
  - Pull the power plug out of the socket before changing the interior lamps of the refrigerator.
    - Otherwise, there is a risk of electric shock.
  - If you experience difficulty changing a non-LED light, contact a Samsung service center.
  - If the product is equipped with LED lamps, do not disassemble the Lamp Covers and LED lamps yourself.
    - Contact a Samsung service center.
  - Plug the power plug into the wall socket firmly.
  - Do not use a damaged power plug, damaged power cord or loose wall socket.
    - This may result in an electric shock or fire.

# Safety information

---

## Usage cautions

---

### CAUTION

- Do not re-freeze frozen foods that have thawed completely. Do not place carbonated or fizzy drinks in the freezer compartment. Do not put bottles or glass containers in the freezer.
  - When the contents freeze, the glass may break and cause personal injury.
- Use only the ice maker provided with the refrigerator.
- To get the best performance from the product:
  - Do not place food too close to the vents at the rear of the refrigerator as this can obstruct free air circulation in the refrigerator compartment.
  - Wrap food up properly or place it in airtight containers before putting it into the refrigerator.
  - Do not place glass bottles or carbonated beverages into the freezer. They can freeze and break. Broken beverage containers can cause injury.
  - Please observe maximum storage times and expiration dates of frozen goods.
- Do not place carbonated or fizzy drinks in the freezer compartment. Do not put bottles or glass containers in the freezer compartment.
  - When the contents freeze, the glass may break and cause personal injury and property damage.
- Service Warranty and Modification.
  - Any changes or modifications performed by a 3rd party on this finished appliance are not covered under Samsung warranty service, nor is Samsung responsible for safety issues that result from 3rd party modifications.
- Do not block the air vents inside the refrigerator.
  - If the air vents are blocked, especially with a plastic bag, the refrigerator can be over cooled. If a cooling period lasts too long, the water filter may break and cause water leakage.
- Wipe excess moisture from the inside and leave the doors open.
  - Otherwise, odor and mold may develop.
- If the refrigerator is disconnected from the power supply, you should wait for at least five minutes before plugging it back in.
- If the refrigerator is flooded by water, there is a risk of electric shock or fire. Pull out the power plug, and then contact a Samsung Electronics service center as soon as possible.
- Do not strike or apply excessive force to any glass surface.
  - Broken glass may result in a personal injury and/or property damage.
- Fill the water tank and ice cube trays with potable water only (tap water, mineral water, or purified water).
  - Do not fill the tank with tea or a sports drink. This may damage the refrigerator.

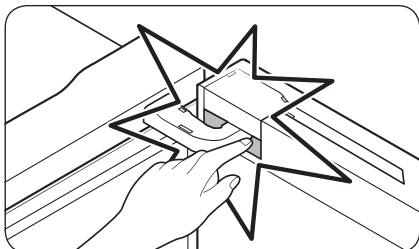

- Be careful that your fingers do not get caught in the door or the space between the door and the door hinge.

- The lamps in the freezer and refrigerator may turn off if the doors of the freezer and refrigerator are left open for 2 seconds or longer.
  - The lamps will turn back on when the doors are closed and opened again.

## Cleaning cautions

### CAUTION

- Do not spray water directly on the inside or outside the refrigerator.
  - There is a risk of fire or electric shock.
- Do not use a hair dryer to dry the inside of the refrigerator.
- Do not place a lighted candle in the refrigerator to remove bad odors.
  - This may result in an electric shock or fire.
- Do not spray cleaning products directly on the display.
  - Printed letters on the display may come off.
- If any foreign substance such as water has entered the appliance, unplug the power plug and contact your nearest Samsung service center.
  - Failing to do so may result in an electric shock or fire.
- Use a clean, dry cloth to remove any foreign matter or dust from the power plug blades. Do not use a wet or damp cloth when cleaning the plug.
  - Otherwise, there is a risk of fire or electric shock.
- Do not clean the appliance by spraying water directly onto it.
- Do not use benzene, thinner, or Clorox, Chloride for cleaning.
  - They may damage the surface of the appliance and may cause a fire.
- Never put fingers or other objects into the dispenser hole.
  - It may cause a personal injury or material damage.
- Before cleaning or performing maintenance, unplug the appliance from the wall socket.
  - Failing to do so may result in an electric shock or fire.



# Safety information

---

## Critical disposal warnings

---

### **WARNING**

- **DANGER:** Risk of child entrapment. Before you throw away your old refrigerator or freezer:
  - Take off the doors and door latch.
  - Leave the shelves in place so that children cannot easily climb inside.
  - Children trapped inside a refrigerator can hurt themselves or suffocate to death.
- Please dispose of the packaging material from this product in an environmentally friendly manner.
- Ensure that none of the pipes on the back of the refrigerator are damaged prior to disposal.
- R-600a is used as a refrigerant. This product contains flammable gas (Refrigerant R-600a), contact your local authority in regard to safe disposal of this product.
- When disposing of this refrigerator, remove the door/door seals and door latch so that small children or animals cannot become trapped inside. Children should be supervised to ensure that they do not play with the appliance. If trapped inside, a child may get hurt or suffocate to death.
  - If trapped inside, the child may get hurt or suffocate to death.
- Cyclopentane is used in the insulation. The gases in the insulation material require a special disposal procedure. Please contact your local authorities in regard to the environmentally safe disposal of this product.
- Keep all packaging materials well out of the reach of children, as packaging materials can be dangerous to children.
  - If a child places a bag over his or her head, the child could suffocate.



---

## Additional tips for proper usage

---

- In the event of a power failure, call the local office of your electric company and ask how long the failure is going to last.
  - Most power failures that are corrected in an hour or two will not affect your refrigerator temperatures. However, you should minimize the number of door openings while the power is off.
  - Should the power failure last more than 24 hours, remove and discard all frozen food.
- The refrigerator might not operate consistently (frozen contents can thaw or temperatures can become too warm in the frozen food compartment) if sited for an extended period of time in a location where ambient air temperatures are constantly below the temperatures for which the appliance is designed.
- Some foods (bananas, etc.) should not be refrigerated. Refrigeration can cause these foods to deteriorate.
- Your appliance is frost free, which means there is no need to manually defrost your appliance. This will be carried out automatically.
- Temperature rise during defrosting complies with ISO requirements. If you want to prevent an undue rise in the temperature of frozen food while the appliance defrosts, wrap the frozen food in several layers of newspaper.
- Do not re-freeze frozen foods that have thawed completely.



# Installation

Follow these instructions carefully to ensure the proper installation of this refrigerator and to prevent accidents before using it.

## WARNING

- Use the refrigerator only for its intended purpose as described in this manual.
- Any servicing must be performed by a qualified technician.
- Dispose of the product packaging material in compliance with the local regulations.

## Refrigerator at a glance

### NOTE

The illustrations of the refrigerator and its component parts shown in this manual may differ from your actual refrigerator and its component parts, depending on the model and your country.

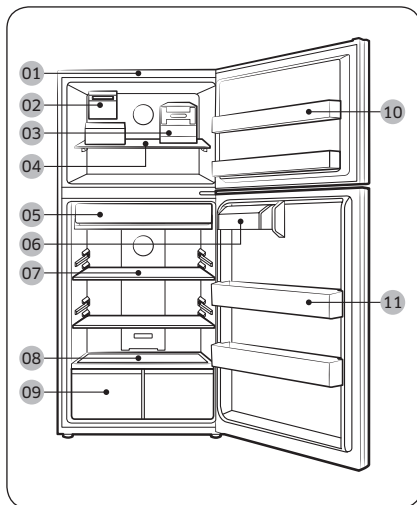

- 01 Control Panel
  - 02 Auto Ice Maker (Optional)
  - 03 Twist Ice Maker (Type A) \*
  - 04 Freezer shelf
  - 05 Slide & Reach Pantry \*
  - 06 Guard container
  - 07 Refrigerator shelves
  - 08 Vegetable shelf
  - 09 Vegetable Drawer
  - 10 Freezer Guard
  - 11 Refrigerator guard
- \* applicable models only

---

## Step-by-step installation

---

### STEP 1 Select a site

---

Select a site that:

- Has a solid, level surface without carpeting or flooring that may obstruct ventilation
- Is away from direct sunlight
- Has adequate room for opening and closing the door
- Is away from any heat sources
- Provides room for maintenance and servicing
- Has a temperature range between 50 °F (10 °C) and 109 °F (43 °C)

# Installation

## Clearance

See the pictures and table below for space requirements for installation.

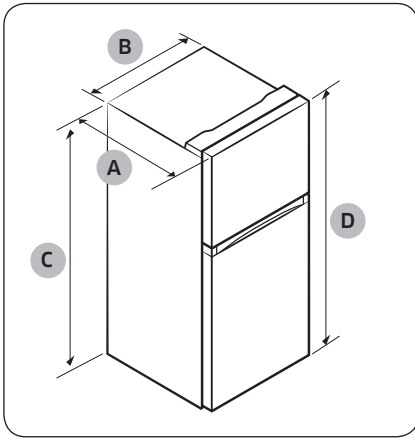

Model	RT18*	RT21*
Depth "A"	31 <sup>7</sup> / <sub>8</sub> " (810 mm)	31 <sup>7</sup> / <sub>8</sub> " (810 mm)
Width "B"	28 <sup>3</sup> / <sub>4</sub> " (729 mm)	32 <sup>7</sup> / <sub>8</sub> " (836 mm)
Height "C"	65 <sup>3</sup> / <sub>4</sub> " (1669 mm)	66 <sup>3</sup> / <sub>4</sub> " (1694 mm)
Overall Height "D"	66 <sup>3</sup> / <sub>4</sub> " (1697 mm)	67 <sup>3</sup> / <sub>4</sub> " (1722 mm)

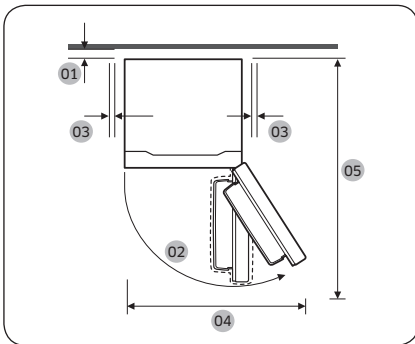

Model	RT18*	RT21*
01	2" (50 mm)	2" (50 mm)
02	121°	121°
03	at least 2" (50 mm)	at least 2" (50 mm)
04	44" (1117 mm)	50 <sup>2</sup> / <sub>5</sub> " (1280 mm)
05	57 <sup>7</sup> / <sub>8</sub> " (1470 mm)	59 <sup>7</sup> / <sub>8</sub> " (1521 mm)



## STEP 2 Flooring

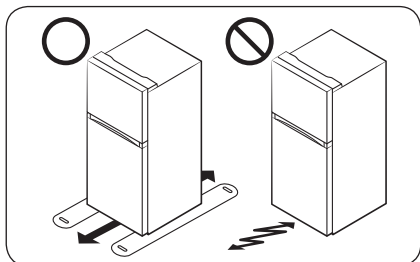

- The surface you install the refrigerator on must support a fully loaded refrigerator. (Approximately 200 lb or 90 kg.)
- To protect the floor, put a large piece of cardboard along the path to the refrigerator's final installation location.
- Once the refrigerator is in its final position, do not move it unless necessary to protect the floor. If you have to move the refrigerator, place thick paper or cloth such as old carpets along the path of movement.

## STEP 3 Adjust the levelling legs

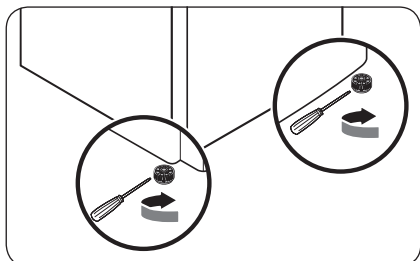

Level the refrigerator by manually adjusting the levelling legs. Turn the levelling legs clockwise to lower the position, or turn counter clockwise to raise. For safety reasons, adjust the front side a little higher than the rear side.

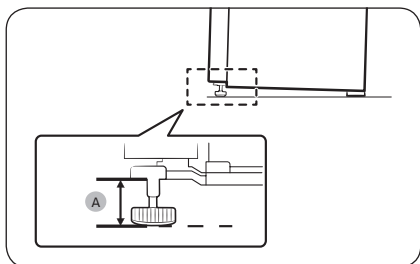

Leave the legs at least (A) mm from the floor as shown.

- (A) 39 mm for RT18\*
- (A) 43 mm for RT21\*



# Installation

## STEP 4 Connect the water line (optional)

Connect the water line to the ice maker. For the ice maker to operate properly, a water pressure of 20-125 psi is required. After you have connected the water line, make sure the water storage tank inside the refrigerator is properly filled.

### CAUTION

Do not reuse an old hose set. Use the new hose sets supplied with your refrigerator only.

- The water line installation is not covered by the Warranty of this product. Read carefully through these instructions to protect your property and prevent possible damage.
- Banging pipes (water banging in the pipes) can cause damage to the refrigerator, and lead to water leakage or flooding. If you encounter this problem, contact a plumber for professional assistance.
- To prevent burns and product damage, do not connect the water line to a hot water source.
- Do not install the water line in areas where temperatures fall below the freezing point.
- When using any electrical device (such as a motorized drill) during installation, be sure the device is insulated and properly grounded to prevent electric shock.
- All installations must be in accordance with local plumbing code requirements.
- The water filter must be replaced as instructed by the manufacturer or the retailer.
- To purchase additional water filters, contact the manufacturer or the retailer of the filter.

### NOTE

- You can purchase the water line installation kit from your retailer. We recommend using a kit that contains copper tubing and a 6 mm ( $1/4$ " ) compression nut.
- In an area with low water pressure (below 20 psi), you can install a booster pump to compensate for the low pressure.



To assemble the water line installation kit

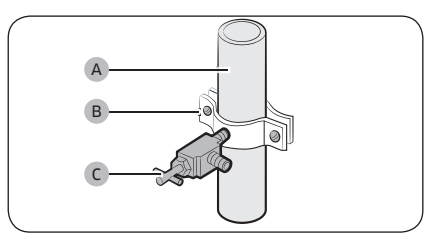

1. Shut off the main water source.
2. Insert the pipe clamp (B) and the shut-off valve (C) into the cold water line (A).

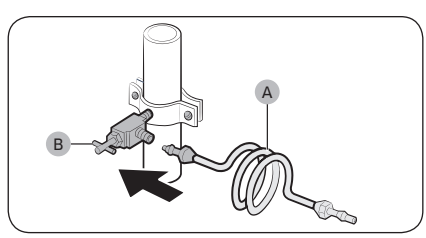

3. Connect the water line installation kit (A) to the shut-off valve (B).

Installation

To connect the water line to the refrigerator

**⚠ WARNING**

Make sure to connect the water line only to a potable water source.

There are several items you must purchase to complete this connection. You may find these items sold as a kit at your local hardware store.

Copper Tubing	<ul style="list-style-type: none"> <li>• 1/4" copper tubing</li> <li>• 1/4" compression nut (1 pc)</li> <li>• Ferrule (2 pc)</li> </ul>
Plastic Tubing	<ul style="list-style-type: none"> <li>• 1/4" plastic tubing → Molded end (Bulb)</li> <li>• 1/4" compression nut (1 pc)</li> </ul>



# Installation

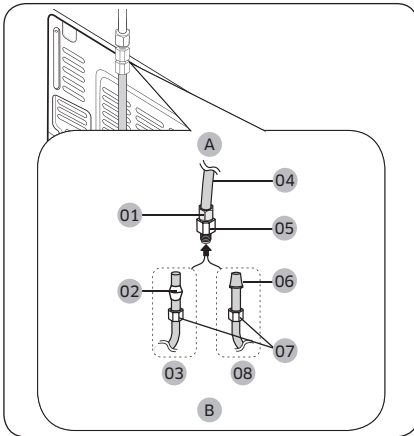

- A. Refrigerator
- B. Household water supply line
- 01 Compression nut (1/4") (Not supplied)
- 02 Ferrule (Not supplied)
- 03 Copper tubing (Not supplied)
- 04 Plastic tubing (Assembled)
- 05 Compression fitting (Not supplied)
- 06 Molded end (Bulb)
- 07 Compression nut (B) (1/4") (Not supplied)
- 08 Plastic tubing (A) (Not supplied)

1. Connect the household water line to the assembled compression fitting.
  - If you are using copper tubing, slip the **compression nut (B)** (not supplied) and **ferrule** (not supplied) on the copper tubing (not supplied) as shown.
  - If you are using plastic tubing (A), insert the molded end (Bulb) of the plastic tubing (A) into the compression fitting.

## CAUTION

If you use plastic tubing, (A) do not use it without the molded end (Bulb).

2. Tighten the **compression nut (B)** onto the **compression fitting**. Do not over-tighten the **compression nut (B)**.
3. Turn the water on and check for any leakage. If you find water drops or leakage in the connection areas, turn off the main water supply. Check the connections and, if necessary, tighten.
4. After you turn on the refrigerator, let the ice maker makes ice for 1 to 2 days. Over that period of time, throw out the first 1 or 2 buckets of ice the ice maker makes to ensure all impurities have been removed from the water line.

## NOTE

- If you have to repair or disassemble the water line, cut off 1/4" of the plastic tubing to make sure you get a snug, leak-free connection.
- Leaving the water line disconnected may cause the water valve to produce a buzzing sound over time.
- If water is not supplied to the refrigerator, make sure to turn the ice maker off.

### Installing a Water Filter (optional)

The water filter and the water filter installation kit containing necessary parts illustrated in this section are not provided. You must purchase the water filter and the water filter installation kit at a local Samsung service center.

To connect to the water supply line

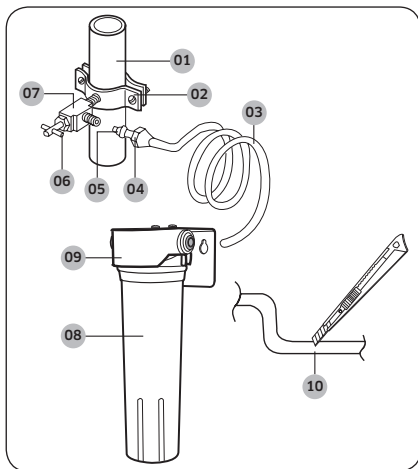

- 01 Cold water line
- 02 Pipe clamp
- 03 Plastic line
- 04 Compression nut
- 05 Compression sleeve
- 06 Packing nut
- 07 Shut off valve
- 08 Filter cartridge
- 09 Cartridge holder
- 10 Cut vertically by 90 degrees

1. Shut off the main water line and turn the ice maker off.
2. Locate the nearest cold potable water line.
3. Follow the instructions mentioned in the water filter installation kit.
4. After connecting the water line to the inlet of the cartridge holder with the plastic line fully inserted, insert and tighten the filter cartridge.
5. Turn on the water line and flush 11 liters of water (approximately 6 minutes) through the filter before use.

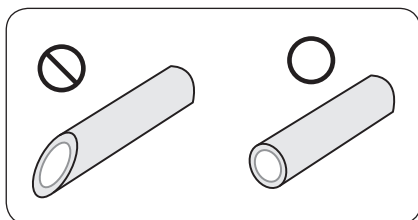

### CAUTION

- The water line must be connected outside of the refrigerator.
- Do not use copper lines.
- If cutting the tubing for resizing, make sure the ends of the tubing are vertically clean cut.

# Installation

To connect the water line to the refrigerator

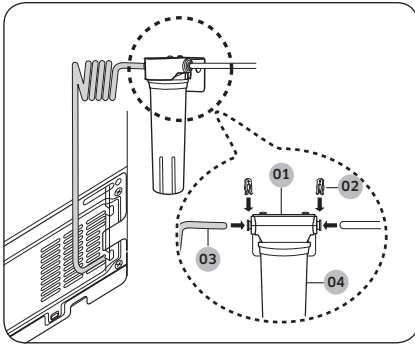

- 01 Cartridge holder
- 02 Plastic clip
- 03 Plastic line
- 04 Filter cartridge

1. Connect the plastic line from the rear of the refrigerator to the outlet of the cartridge holder until the plastic line is fully inserted.
2. Clamp both ends of the cartridge holder using the plastic clips.
3. Turn the water line on and check for leaks.

## CAUTION

- Use only potable water.
- The filter cartridge is not provided. You must purchase it at a local Samsung service center.
- When moving the refrigerator for line connection, use caution so that you don't step on the power cord or water line (for the ice maker).

---

## STEP 5 Unpack and put accessories in place

The accessories that ship with this refrigerator are properly packed for transportation and safety reasons. Unpack those accessories and put them in place.

### Door guards

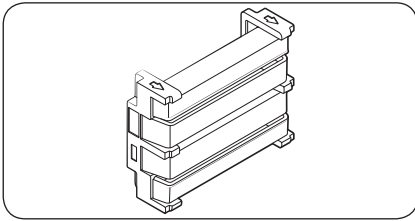
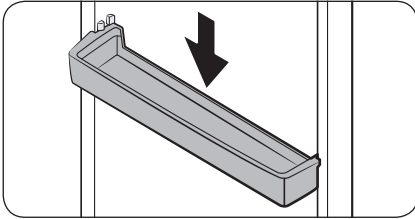

There are four door guards provided with the product. Insert two door guards each to the freezer and the fridge.

# Installation

## STEP 6 Install the Auto Ice Maker (optional)

To purchase a new auto ice maker (part type : RA-TIMO63PP/AA), visit the Samsung website ([www.samsung.com](http://www.samsung.com)) or contact your retailer.

Ice maker kit

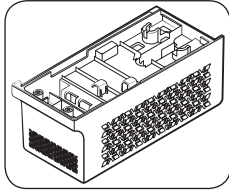

Ice maker

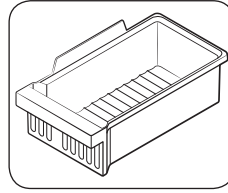

Ice bucket

Tools required (not provided)

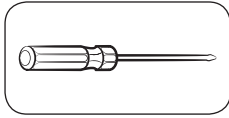

Phillips screwdriver

To install the ice maker kit

## **WARNING**

To prevent electrical shock, make sure the refrigerator is turned off before installation.

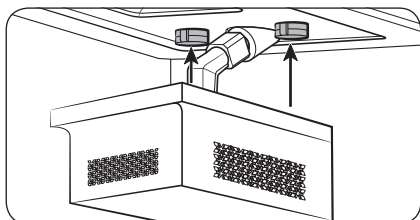
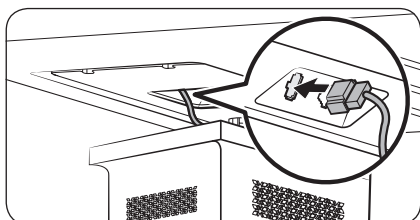
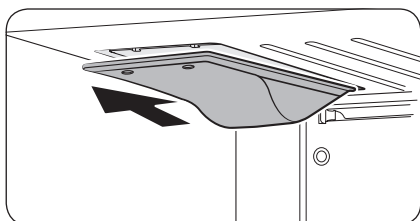
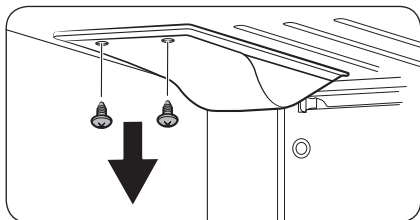

1. See the figure on the left, and then locate the cover on the inner upper corner of the main unit.
2. Remove the screws (x2) from the cover, and then remove the cover by pulling it to the front.
3. Connect the wire connector of the ice maker to the socket (marked in the figure) on the main unit. Make sure the connector is fully inserted to prevent system failure.
4. Insert the ice maker into the front side of the 2 grommets as shown. Then, push the ice maker inwards to the end. To prevent deviation of the ice maker, make sure the ice maker fits into position.

# Installation

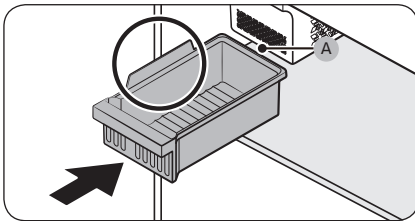
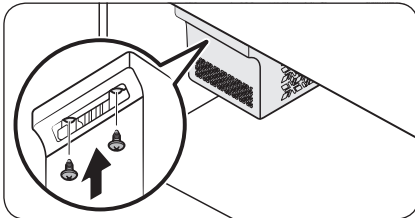
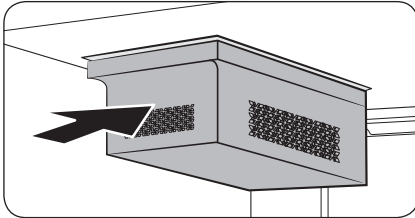

5. Tighten the provided screws (x2) to attach the ice maker firmly to the refrigerator.
  - Make sure the screw holes are aligned with each other before tightening the screws.

6. Put the **ice bucket** on the shelf as shown. By design, the **ice bucket** is supposed to sit behind the ice maker. Otherwise, the ice cubes from the ice maker will not collect in the bucket as intended.

7. When installation is complete, turn the refrigerator on, and then press **Test Switch (A)** on the ice maker to check if the ice maker operates and supplies water for the ice tray normally.

## ⚠ CAUTION

- If you don't intend to use the ice maker, or if you are going for a business trip or vacation, turn off the ice maker.
- Do not turn the ice maker on without the ice bucket in place. The ice cubes produced by the ice maker will drop into and scatter through out the freezer.
- Noises may occur when the ice maker is making ice or being supplied with water, or when ice cubes drop into the ice bucket. However, this is not a system failure. When the ice bucket is full, none of these noises will occur.
- The first time you use the ice maker, or after you have replaced the water filter, the ice made by the ice maker may have a carbon residue. If this happens, discard the first full load of ice. Note that the carbon residue is harmless to humans.



---

## STEP 7 Initial settings

---

By completing the following steps, the refrigerator should be fully functioning.

1. Plug the power cord into the wall socket to turn the refrigerator on.
2. Open the door, and check if the interior light lights up.
3. Set the temperature to the coldest setting, and wait for about an hour. Then, the freezer should be slightly chilled, and the motor should be running smoothly.
4. Wait until the refrigerator reaches the set temperature. The refrigerator is now ready for use.

## STEP 8 Final check

---

When installation is complete, confirm that:

- The refrigerator is plugged into an electrical outlet and grounded properly.
- The refrigerator is installed on a flat, level surface with a reasonable clearance from the wall or the cabinet.
- The refrigerator is level and is sitting firmly on the floor.
- The door opens and closes freely, and the interior light turns on automatically when you open the door.



# Operations

## Feature panel

### Type A

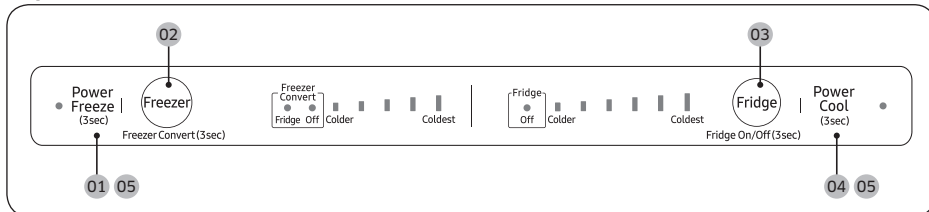

### Type B

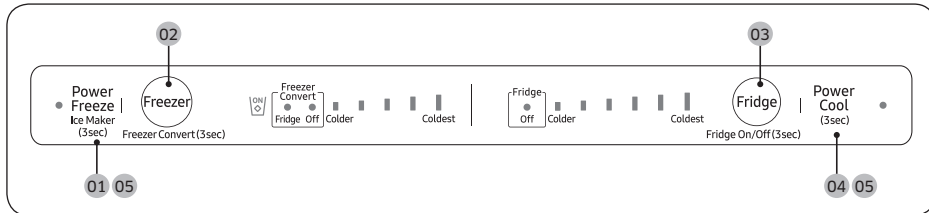

**01** Power Freeze /  
Ice Maker (applicable models only)

**02** Freezer / Freezer Convert

**03** Fridge / Fridge On/Off

**04** Power Cool

**05** Sabbath mode



## 01 Power Freeze / Ice Maker (applicable models only)

<p>Power Freeze</p>	<p>Power Freeze speeds up the freezing process at maximum fan speed. The freezer keeps running at full speed for several hours and then returns to the previous temperature.</p> <ul style="list-style-type: none"> <li>To activate Power Freeze, press and hold <b>Power Freeze</b> for 3 seconds (Type A), or press and release <b>Power Freeze</b> within 3 seconds (Type B). The corresponding indicator (❄️) lights up, and the refrigerator will speed up the freezing process for you.</li> <li>For Type B, do not hold down <b>Power Freeze</b> for 3 seconds or more. This will activate the ice maker, not Power Freeze.</li> <li>To deactivate, press and hold <b>Power Freeze</b> for 3 seconds (Type A), or press and release <b>Power Freeze</b> within 3 seconds (Type B). The freezer returns to the previous temperature setting.</li> <li>To freeze large amounts of food, activate Power Freeze for at least 20 hours before putting food in the freezer.</li> <li>The freezer keeps running at full speed for 50 hours and then returns to the previous temperature.</li> </ul> <p><b>NOTE</b></p> <p>Using Power Freeze increases power consumption. Make sure you turn it off and have the Freezer return to its previous temperature if you no longer need Power Freeze on.</p>
<p>Ice Maker (applicable models only)</p>	<p>By default, the refrigerator is set to make ice with the ice maker indicator on.</p> <p>To disable this function, press and hold <b>Ice Maker</b> for 3 seconds. We recommend disabling the function in the following cases:</p> <ul style="list-style-type: none"> <li>The ice bucket is already full of ice.</li> <li>You want to decrease power consumption.</li> <li>When removing the ice maker while it is operating, the ice maker automatically turns off, and the ice maker button (holding down <b>Power Freeze</b>) will be disabled.</li> <li>If reattaching the removed ice maker while the refrigerator is on, the ice maker automatically turns on.</li> </ul>

## 02 Freezer / Freezer Convert (3 sec)

<p>Freezer</p>	<p>The <b>Freezer</b> button can be used to set the freezer temperature.</p> <p><b>CAUTION</b></p> <ul style="list-style-type: none"> <li>To prevent system failure or food spoiling, do not set the temperature to Colder in summer (when temperatures are above 95 °F (35 °C)).</li> <li>Do not store glass bottles containing liquid in the freezer. Glass bottles will crack or break into pieces when the liquid freezes.</li> </ul>
----------------	---



# Operations

## Freezer Convert

You can use the freezer as a freezer only, set the entire refrigerator including the freezer to Fridge mode, or turn off the freezer.

To change the default freezer mode, press and hold **Freezer Convert** for 3 seconds to enter the selection mode. Then, press **Freezer Convert** to select a desired mode.

The mode changes in this sequence: Fridge → Off → Freezer, then back to Fridge.

- If you select Fridge, the fridge indicator turns on. The freezer will operate in Fridge mode with refrigerator temperatures (above freezing). Power Freeze will be deactivated if active, and Ice On will turn off if enabled.
- If you select Off, the Off indicator turns on. The freezer will be turned off.
- If you switch to Fridge or Off mode, the ice maker automatically turns off after 15 seconds. Empty the ice bucket before you select these modes.
- If you select Freezer, the freezer temperature indicators turn on and the freezer will operate as a freezer (with temperatures below freezing).
- If you switch back to Freezer mode from Fridge or Off mode, the ice maker automatically turns on.

Your changes will be set and activated after 10 seconds. To cancel or change the mode again, press and hold **Freezer Convert** again for 3 seconds. Then, follow the instructions above.

### NOTE

- If you press and hold **Freezer Convert** for 3 seconds in other modes, the refrigerator switches to selection mode where you can press **Freezer Convert** to select a different mode.
- When the fridge or the freezer is set to Off mode, the temperature of the fridge or the freezer remains under 59 °F (15 °C) to prevent mold and odors. The refrigerator will use less electricity.
- The fridge and the freezer cannot be powered off independently.
- Do not store food or beverages in the refrigerator when the refrigeration or freezer functions are set to 'Off mode'. 59 °F (15 °C) is not cool enough to prevent spoilage.

## WARNING

- Do not put glass bottles containing liquid in the freezer. When you cancel Freezer Convert and the freezer returns to freezer mode, the liquid in the glass bottles will freeze which can cause the glass bottles to break or burst in the freezer.
- Make sure to remove frozen foods from the freezer before you use Freezer Convert to convert the freezer to Fridge mode. Frozen foods will melt and spoil as the temperature increases.





- Make sure to remove chilled foods from the freezer before using Freezer Convert to change the freezer to Freezer mode. Chilled foods may freeze as the temperature decreases.



 **NOTE**

If you want to use Freezer Convert, we strongly recommend that you use plastic containers to store food, especially vegetables.

### 03 Fridge / Fridge On/Off (3 sec)

Fridge	<p>To adjust the fridge temperature, press <b>Fridge</b> to select the corresponding temperature.</p> <p> <b>CAUTION</b></p> <ul style="list-style-type: none"> <li>• In winter, do not set the temperature control to Coldest. This may cause problems with the cooling performance.</li> <li>• In summer, do not set the temperature control to Colder. This may also cause problems with the cooling performance.</li> </ul>
Fridge On/Off	<p>Press and hold <b>Fridge</b> for 3 seconds to select Fridge On/Off. The temperature indicator will turn off and the Fridge On/Off indicator will turn on.</p> <p> <b>NOTE</b></p> <ul style="list-style-type: none"> <li>• In Fridge On/Off mode, the temperature of the fridge or freezer remains under 59 °F (15 °C) to prevent mold and odors. The refrigerator uses less electricity.</li> <li>• Do not store food or beverages in the refrigerator when the refrigeration or freezer functions are set to 'Off mode'. 59 °F (15 °C) is not cool enough to prevent spoilage.</li> </ul>

### 04 Power Cool (3 sec)

Power Cool	<p>Power Cool speeds up the cooling process at maximum fan speed. The fridge keeps running at full speed for several hours and then returns to the previous temperature.</p> <ul style="list-style-type: none"> <li>• To activate Power Cool, press and hold <b>Power Cool</b> for 3 seconds. The corresponding indicator () lights up, and the refrigerator will speed up the cooling process for you.</li> <li>• To deactivate Power Cool, press and hold <b>Power Cool</b> again for 3 seconds. The fridge returns to the previous temperature setting.</li> <li>• To cool large amounts of food completely, make sure you have activated Power Cool at least 24 hours in advance.</li> </ul> <p> <b>NOTE</b></p> <p>Using Power Cool increases power consumption. Make sure you turn it off and have the Fridge return to its previous temperature if you no longer need Power Cool on.</p>
------------	---



# Operations

Cooling Off mode	<p><b>North American (US, Canada) Models Only</b></p> <p>Cooling Off mode (also called Shop mode), is designed for use by retailers when they are displaying refrigerators on the shop floor. In Cooling Off mode, the refrigerator's fan motor and lights work normally, but the compressors do not run, and the refrigerator and freezer do not get cold.</p> <ul style="list-style-type: none"><li>• To start Cooling Off mode, press and hold <b>Power Freeze</b>, <b>Freezer</b> and <b>Fridge</b> simultaneously for 5 seconds during normal operation. The refrigerator chime sounds and the temperature LEDs will light up sequentially from left LED to right LED.</li><li>• To cancel Cooling Off mode, press and hold <b>Power Freeze</b>, <b>Freezer</b> and <b>Fridge</b> simultaneously again for 5 seconds.</li></ul>
------------------	--

## 05 Sabbath mode

The Sabbath mode stays active for 85 hours once it is activated. After that, it will be deactivated automatically.

- To activate, press and hold **Power Freeze** and **Power Cool** simultaneously for 5 seconds to enter Sabbath mode. The refrigerator will operate in Sabbath mode where the buttons, display, and the room lamps are controlled by Sabbath mode.
- To deactivate, press and hold the buttons again for 5 seconds to exit Sabbath mode.

### NOTE

Even after the refrigerator powers off and restarts, the Sabbath mode remains active. To exit Sabbath mode, you must deactivate it.

---

## Special features

---

Your refrigerator and its special functions may differ from the images and functions presented in this section depending on your model and country.

### Ice making (applicable models only)

#### Twist ice maker

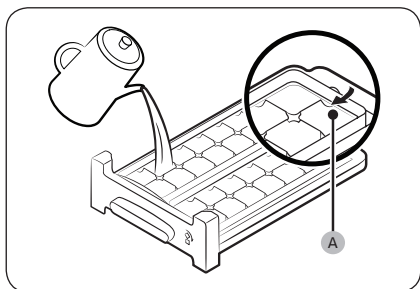

1. Open the freezer door, and slide open the ice tray.
2. Fill the tray with water up to the **maximum level (A)** marked on the inner rear of the tray.
3. Slide the tray back into position.

 **NOTE**

The ice making time depends on your temperature settings.

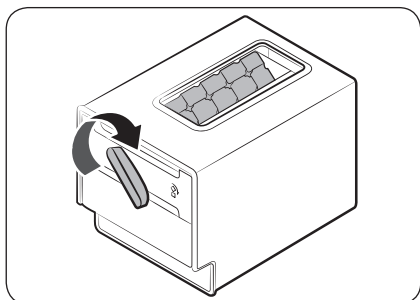

 **NOTE**

- Make sure the ice bucket is in place under the ice tray.
- To dispense the ice cubes, turn the handle of the bin to the right to empty half of the ice cubes into the bin. Then, turn it to the left to empty the other half.
- Take out the bin by slightly twisting and pulling to the front.

# Operations

## Auto ice maker (applicable models only)

For first-time use

- Let the ice maker make ice for 1-2 days.
- Discard the first 1-2 buckets of ice to remove impurities in the water supply system.
- When the upper ice tray is full, use the lower ice tray.

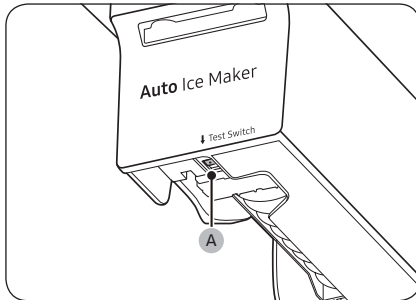

If the auto ice maker does not make ice, remove the ice bucket and press **Test Switch (A)** to check if the auto ice maker operates properly.

# Maintenance

## Door reversal (applicable models only)

The door reversal process must be performed by Samsung-approved servicing personnel at your own expense. Door reversal is not covered by your warranty.

### **WARNING**

- Door reversal failure or property damage caused by unauthorized servicers is not covered by your warranty.
- Make sure that the refrigerator is disconnected from the power source before reversing the doors.
- After reversing the door, wait at least one hour before plugging the refrigerator in. This is to prevent electric shock that could occur.

### Tools required (not provided)

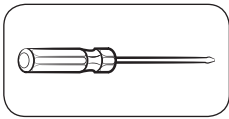

Phillips screwdriver

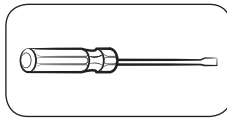

Flat-head screwdriver

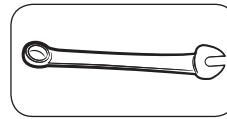

$\frac{7}{16}$ " (11 mm) spanner  
(for hinge shaft)

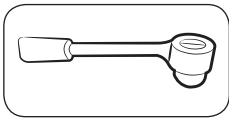

$\frac{5}{16}$ " (8 mm) socket wrench  
(for bolts)

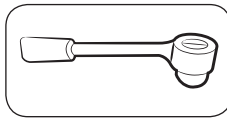

$\frac{3}{8}$ " (10 mm) socket wrench  
(for bolts)

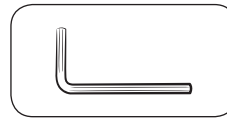

$\frac{3}{16}$ " (5 mm) Allen wrench  
(for middle hinge)

### Accessories

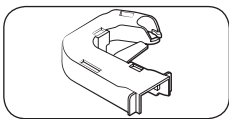

Hinge Cover (L)

### **CAUTION**

Throughout the entire reversing procedure, keep all the small parts (screws, caps, etc.) of the refrigerator away from children or infants for safety reasons.

# Maintenance

## Step-by-step instructions

### STEP 1 Remove the doors

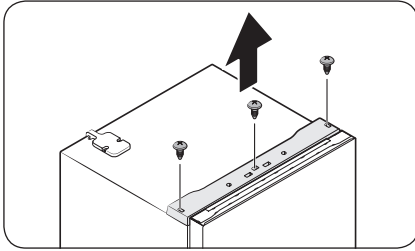

1. Use a Phillips screwdriver to loosen the screws (x3) in three holes on the top table. Then, gently pull out the top table.

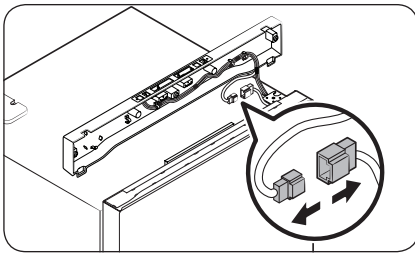

2. Decouple the wire connectors.

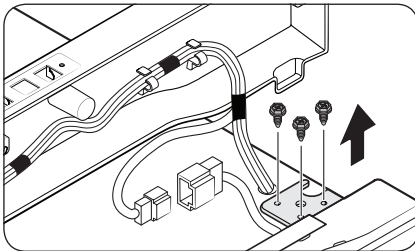

3. Loosen the bolts on the top hinge.

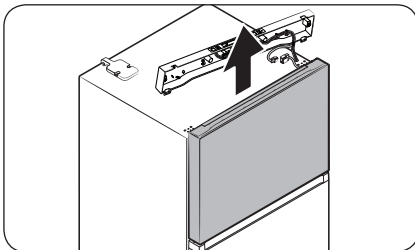

4. Gently lift up the freezer door to remove it.

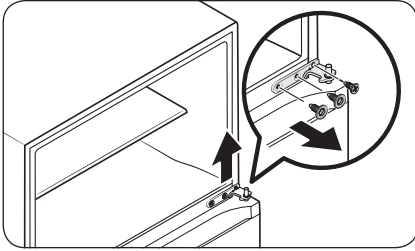

5. Use the screwdriver and the wrench to loosen the bolts and remove the **middle hinge**.

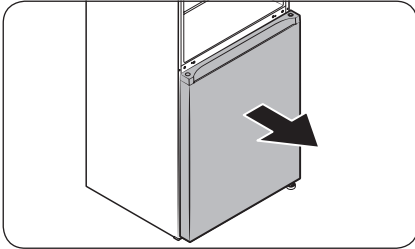

6. Gently slide the **fridge door** out of the **hinge shaft**, and then pull up to remove.

# Maintenance

## STEP 2 Remove the hinges and shafts

To facilitate the reversing process, gently lay the refrigerator down on a flat floor covered by a cushion or rug.

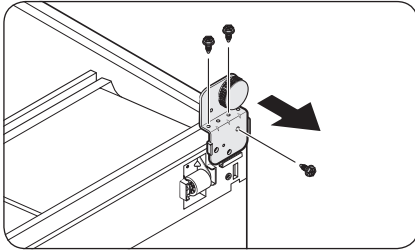

1. Use the screwdriver to remove the bottom hinge.

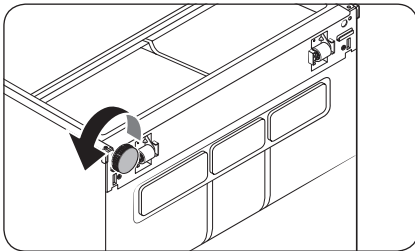

2. Remove the levelling leg on the opposite side by turning it counterclockwise.

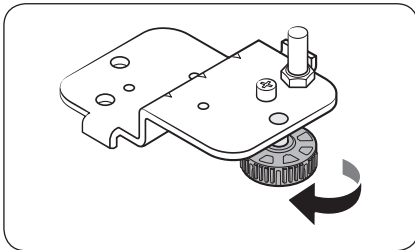

3. Remove the levelling leg from the bottom hinge by turning it clockwise.

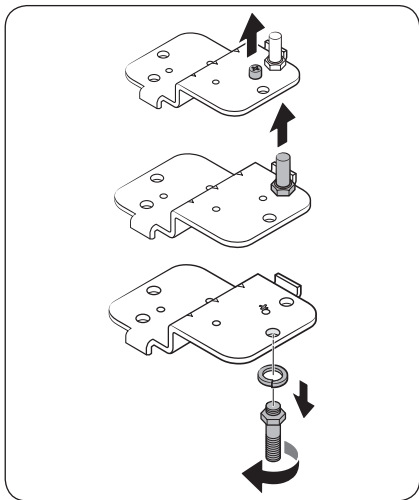

4. Use the screwdriver to remove the **hinge bolt**. Then, use the wrench to remove the **door shaft**, and then the **leg bolt** with the **spring washer**.

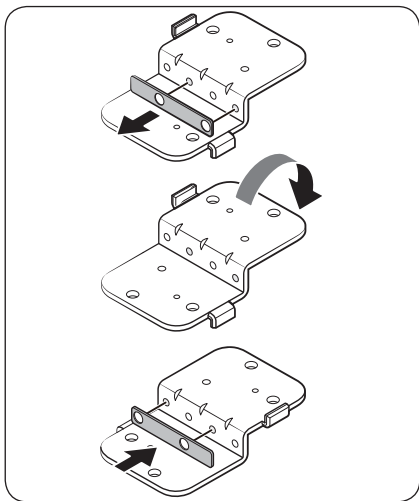

5. Detach the hinge shim manually, which has been attached using double-sided tape. Turn the bottom hinge over, and then reattach the hinge shim to the opposite side.

# Maintenance

## STEP 3 Reverse the auto closer (freezer door only)

Now stand the refrigerator back upright with care, and then do the following.

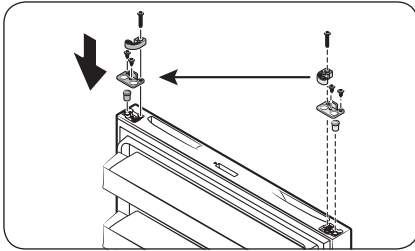

1. Remove the **auto closer** and the **stopper** from the bottom of the fridge door. Then, reinsert them on the opposite side of the fridge door as shown.

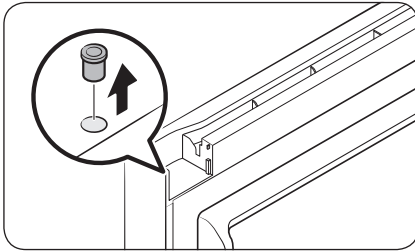

2. Use a flat-head screwdriver to remove the **hinge grommet**.

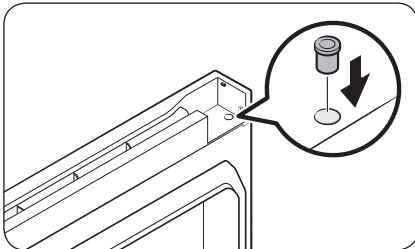

3. Reinsert the **hinge grommet** on the opposite side.

---

## STEP 4 Reverse the bar cover and the top hinge

---

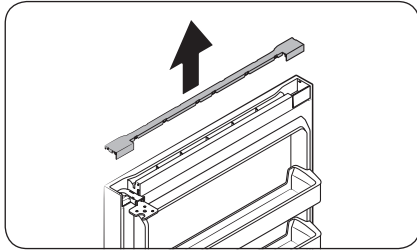

1. Pull up to remove the **bar cover** on the top of the freezer door.

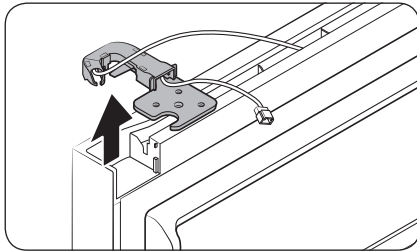

2. Remove the **top hinge** with its cover.

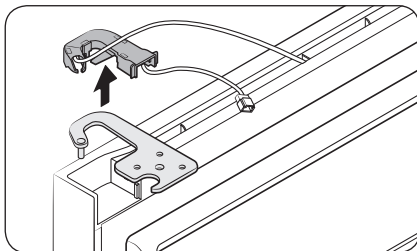

3. Separate the **top hinge** from the hinge cover.

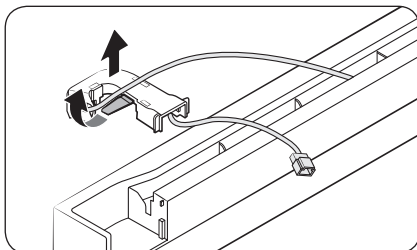

4. Arrange the door wire in the hinge cover.

# Maintenance

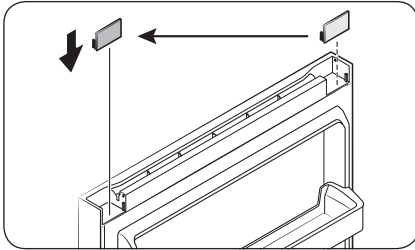

5. Remove the **cap spacer**, and then reinsert it on the opposite side.

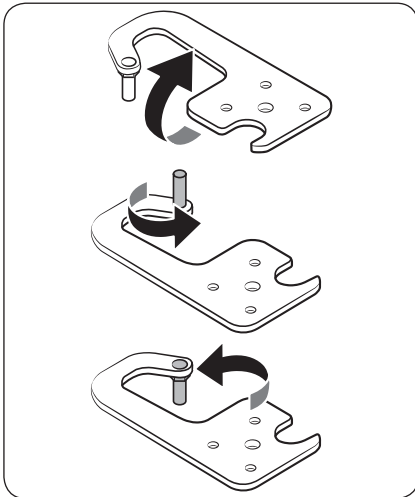

6. Remove the **door shaft** from the **top hinge**, flip it 180 degrees as shown, and then reinsert it .

---

## STEP 5 Reattach the doors on the opposite side

---

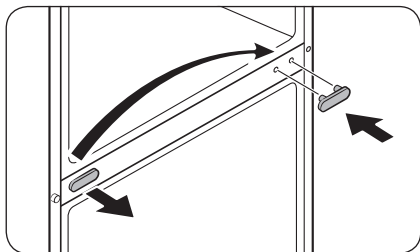

1. Use a flat-heat screwdriver to remove the **middle-hinge screw cap**, and then reinsert it on the opposite side.

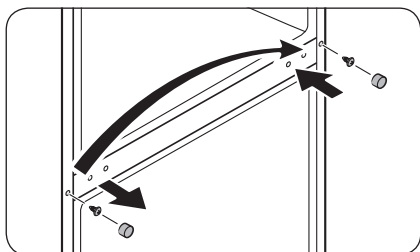

2. Use the flat-heat screwdriver to remove the **flange-screw cap** to reveal the **flange screw**. Use a Phillips screwdriver to remove the **flange screw**, and then tighten it on the opposite side. Finally, close the **flange-screw cap** on the opposite side.

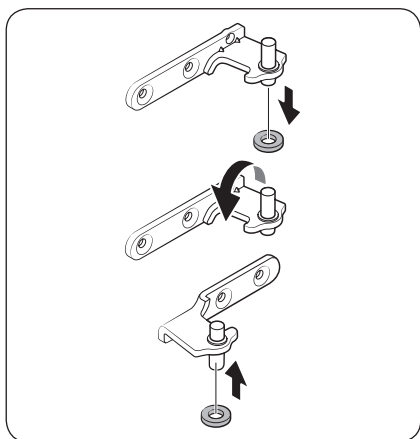

3. Remove the **grommet ring** from the **middle-hinge shaft**, and then reinsert the ring on the other side of the shaft. See the figure for visual reference.

# Maintenance

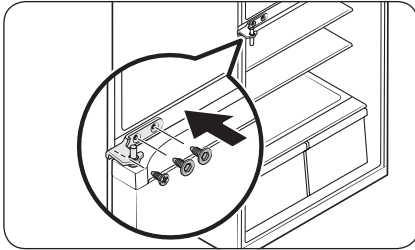

4. Reverse the **middle hinge** and insert it on the opposite side. Then, tighten the hinge with the screws.

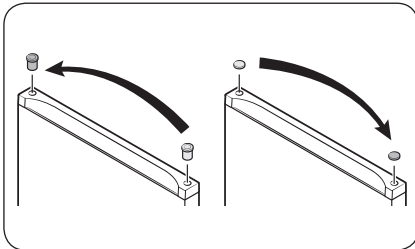

5. Use the flat-head screwdriver to remove both the **hinge grommet** on one side and the **hinge-hole cap** on the other side. Reinsert them on their respective opposite side.

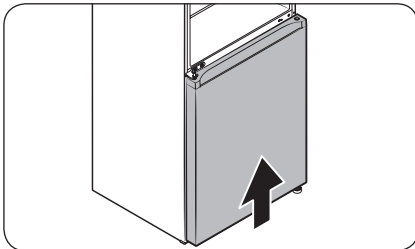

6. Gently slide the **fridge door** into the correction position so that it fits.

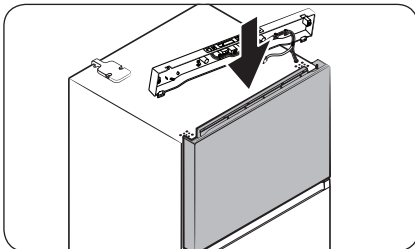

7. Gently slide the **freezer door** into the correction position so that it fits.

---

## STEP 6 Reverse the shaft and the leg

---

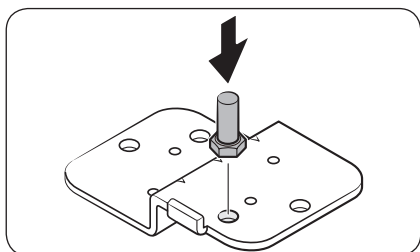

1. Reverse the **bottom hinge**, insert the **door shaft** into it, and then tighten the door shaft.

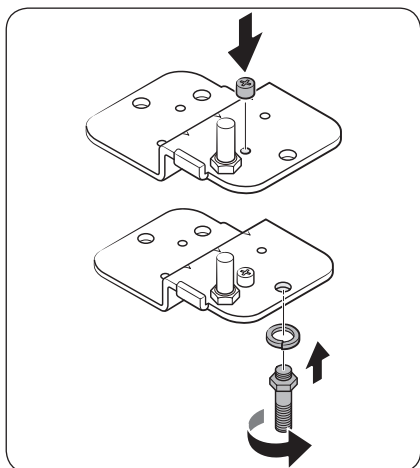

2. Insert the **hinge bolt** and the **spring washer**, and then the **leg bolt** into the **bottom hinge**. Then, tighten them by turning them clockwise.

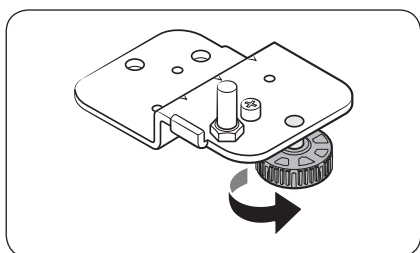

3. Insert the hinge-side **levelling leg**, and then tighten it by turning it clockwise.

# Maintenance

---

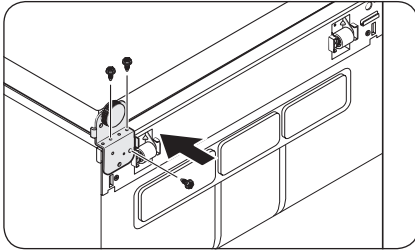

4. Insert the **bottom hinge** in the opposite side, and then tighten it.

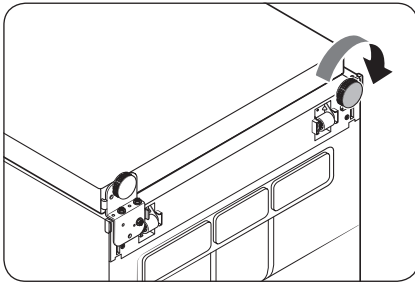

5. Insert and tighten the other **levelling leg** by turning it clockwise.

---

## STEP 7 Reattach the remaining parts

---

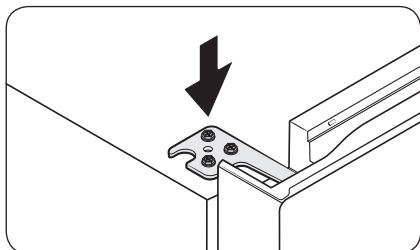

1. Insert and tighten the **top hinge** on the opposite side.

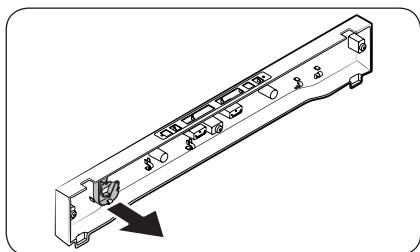

2. Detach the **hinge cover** manually from the **top table**.

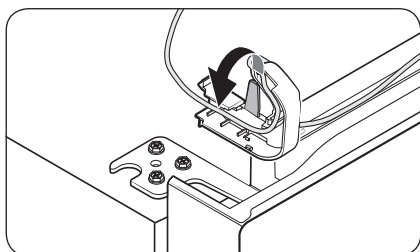

3. Arrange the **door wire** in the **hinge cover** before placing the **hinge cover** onto the **top hinge**.

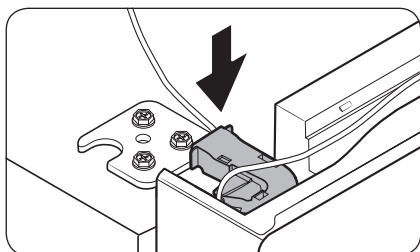

# Maintenance

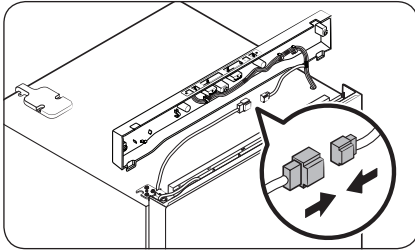

4. Connect the wire connectors.

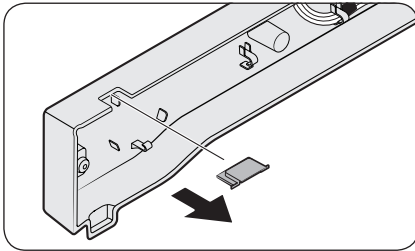

5. Remove the **hinge hole cap** from the **top table**, and then reinsert it on the opposite side.

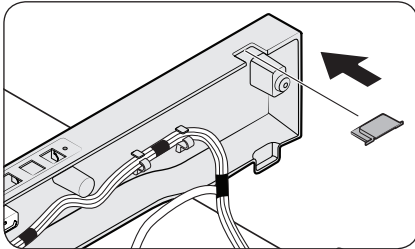

6. Insert the **top table**, and then fix it firmly to the refrigerator using the screws (x3).

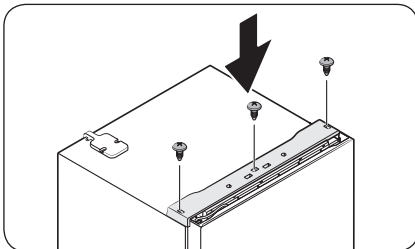

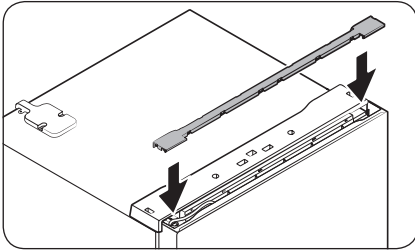

7. Insert the bar cover.

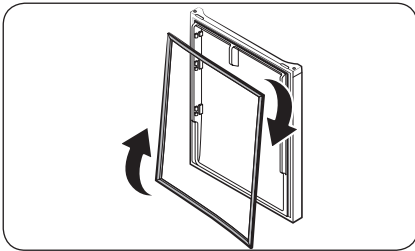

8. Remove the fridge door and freezer door gaskets. Turn them clockwise by 180 degrees, and then reattach them.

 **NOTE**

In the future, you might want to return the doors to their initial position (before the doors were reversed). In that case, refer to the instructions on the previous pages, but switch the doors, hinges, and covers back to their initial positions.

# Maintenance

## Handle and care

### Shelves (fridge/freezer)

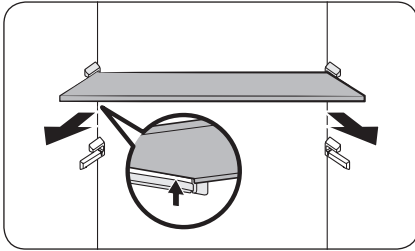

To remove the shelf, hold it with both hands and lift to release from the rear hooks. Then, pull it halfway to the front.

### Fresh room

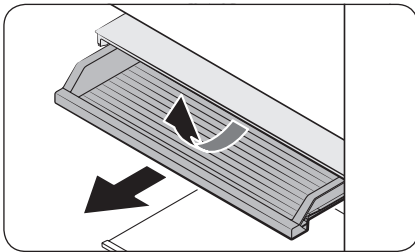

Slide out the sliding shelf of the Fresh room.

### Vegetable drawers

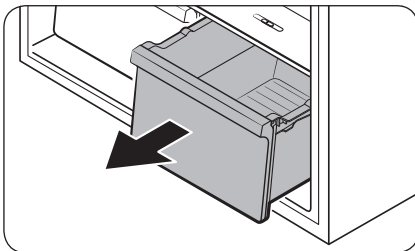

Gently lift up the front of the drawer, and then slide it out.

## Vegetable shelf

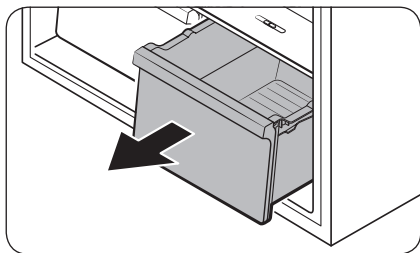

1. Gently lift up the front of the drawer, and then slide it out.

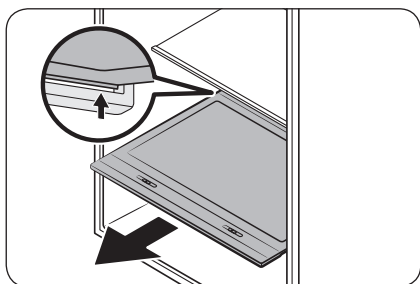

2. Hold the vegetable shelf with both hands, and then slide it out.

## Door shelves

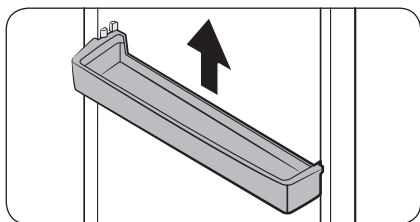

Lift up the door shelf slightly, and then pull it out .

### **CAUTION**

To prevent accidents, empty the door guards before removing.

# Maintenance

---

## Cleaning

---

Regularly use a dry cloth to remove all foreign substances such as dust or water from the power plug terminals and contact points.

1. Unplug the power cord of the refrigerator.
2. Use a moistened, soft, lint-free cloth or paper towel to clean the refrigerator's interior and exterior.
3. When done, use a dry cloth or paper towel to dry the refrigerator well.
4. Plug in the power cord of the refrigerator to turn the refrigerator on.

### NOTE

If you have removed any removable parts such as shelves for cleaning, refer to the overall layout in the **Refrigerator at a glance** section to make sure you have re-inserted them correctly.

### WARNING

- Do not use benzene, thinner, home/car detergent, or Clorox™ to clean your refrigerator. They may damage the surface of the refrigerator and cause a fire.
- Do not spray water onto the refrigerator. This may cause electric shock.

## Replacement

---

### Lamps

The lamps are not user-serviceable. To replace the lamps of the refrigerator, contact a local Samsung service center.

# Troubleshooting

If you encounter a problem with the refrigerator, first check the tables starting below, and then try the suggested solutions. If none of the suggested solutions resolve your problem, please visit our website at [www.samsung.com](http://www.samsung.com) or call Samsung Customer Care at 1-800-SAMSUNG (726-7864).

## General

### Temperature

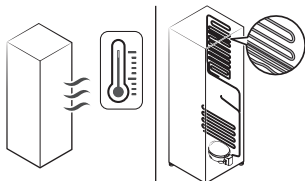
Symptom	Possible causes	Solution
Fridge/freezer does not operate. Fridge/freezer temperature is warm.	<ul style="list-style-type: none"> <li>Power cord is not plugged in properly.</li> </ul>	<ul style="list-style-type: none"> <li>Properly plug in the power cord.</li> </ul>
	<ul style="list-style-type: none"> <li>Temperature control is not set correctly.</li> </ul>	<ul style="list-style-type: none"> <li>Set the temperature lower.</li> </ul>
	<ul style="list-style-type: none"> <li>Refrigerator is located near a heat source or in direct sunlight.</li> </ul>	<ul style="list-style-type: none"> <li>Keep the refrigerator away from direct sunlight or a heat source.</li> </ul>
	<ul style="list-style-type: none"> <li>Not enough clearance between refrigerator and sides/rear.</li> </ul>	<ul style="list-style-type: none"> <li>Make sure that there is at least a 2 inch/5 cm gap between the refrigerator's rear and sides and any nearby walls.</li> </ul>
	<ul style="list-style-type: none"> <li>The refrigerator is overloaded. Food is blocking the refrigerator vents.</li> </ul>	<ul style="list-style-type: none"> <li>Do not overload the refrigerator. Do not allow food to block ventilation.</li> </ul>
Fridge/freezer is over-cooling.	<ul style="list-style-type: none"> <li>Temperature control is not set correctly.</li> </ul>	<ul style="list-style-type: none"> <li>Set the temperature higher.</li> </ul>
Interior wall is hot.	<ul style="list-style-type: none"> <li>Refrigerator has heat-proof piping in the interior wall.</li> </ul>	<ul style="list-style-type: none"> <li>To prevent condensation from forming, the refrigerator has heat-proof piping in the front corners. If the ambient temperature rises, this equipment may not work effectively. This is not a system failure.</li> </ul> 

# Troubleshooting

## Odors

Symptom	Possible causes	Solution
Refrigerator has odors.	• Spoiled food.	• Clean the refrigerator and remove any spoiled food.
	• Food with strong odors.	• Make sure strong smelling food is wrapped airtight.

## Frost

Symptom	Possible causes	Solution
Frost around the vents.	• Food is blocking the vents.	• Make sure no food blocks the refrigerator vents.
Frost on interior walls.	• Door is not closed properly.	• Make sure food does not block the door. Clean the door gasket.
Fruits or vegetables are frozen.	• Fruits or vegetables are stored in the Fresh/Chef Zone.	• The Fresh/Chef Zone is only for meat/fish.

## Condensation

Symptom	Possible causes	Solution
Condensation forms on the interior walls.	• If door is left open, moisture enters the refrigerator.	• Remove the moisture and do not leave the door open for extended periods of time or open the door frequently.
	• Food with high moisture content.	• Make sure food is wrapped airtight.

## Auto Ice Maker

Symptom	Possible causes	Solution
The ice maker does not produce ice.	<ul style="list-style-type: none"><li>• The freezer room is not cold enough.</li></ul>	<ul style="list-style-type: none"><li>• Make sure the cold air outlet is not clogged.</li></ul>
	<ul style="list-style-type: none"><li>• The ice maker is turned off.</li></ul>	<ul style="list-style-type: none"><li>• Make sure the ice maker is turned on. Press and hold <b>Power Freeze</b> for 3 seconds, and check if the corresponding indicator turns on.</li></ul>
	<ul style="list-style-type: none"><li>• The wire connector of the ice maker is not connected properly.</li></ul>	<ul style="list-style-type: none"><li>• Make sure the wire connector from the wire housing is connected properly.</li></ul>
	<ul style="list-style-type: none"><li>• The water line flowing to the ice maker is bent or kinked.</li></ul>	<ul style="list-style-type: none"><li>• Make sure the water line in the rear of the refrigerator is not bent or kinked.</li></ul>

# Troubleshooting

## Do you hear abnormal sounds from the refrigerator?

Before calling for service, review the information below. Note that you will be charged for any service calls related to normal operating sounds in which no defects were found. If you have any questions about sounds your refrigerator is making, please call Samsung Customer Care at 1-800-SAMSUNG (726-7864).

### These sounds are normal.

- When starting or ending an operation, the refrigerator may make sounds similar to a car engine ignition. As the operation stabilizes, the sounds will decrease.

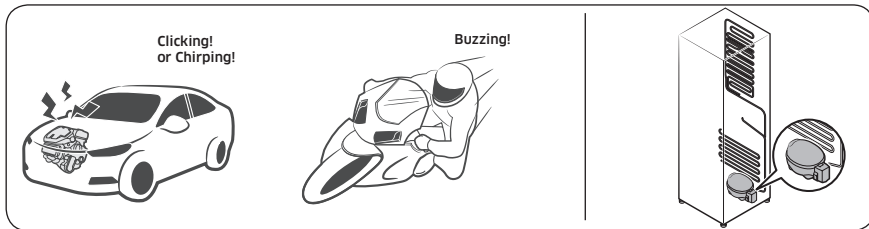

- While the fan is operating, these sounds may occur. When the refrigerator reaches the set temperature, no fan sound will occur.

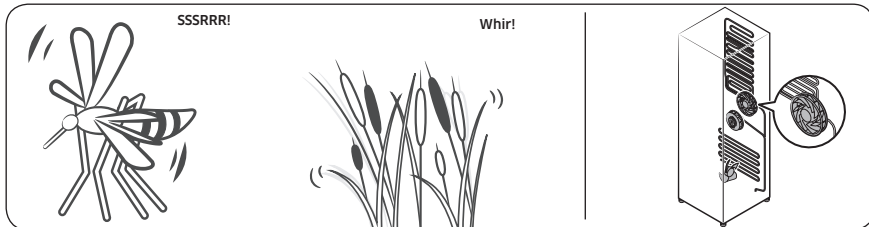



- During a defrost cycle, water may drip on the defrost heater, causing sizzling sounds.



- As the refrigerator cools or freezes, refrigerant gas moves through sealed pipes, causing bubbling sounds.

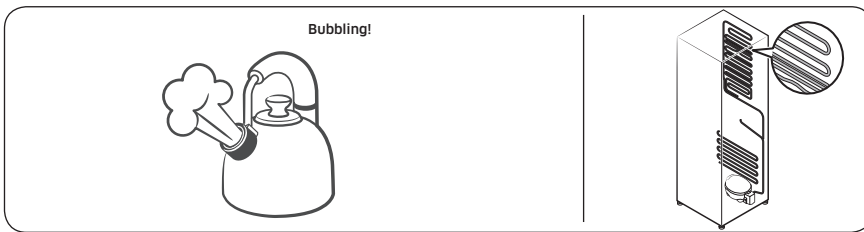

- As the refrigerator temperature increases or decreases, plastic parts contract and expand, creating knocking noises. These noises occur during the defrosting cycle or when electronic parts are working.

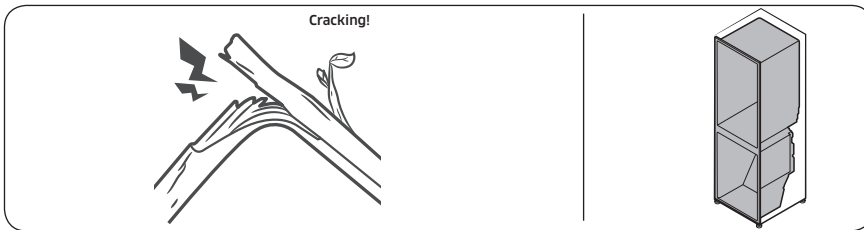

- For ice maker models: When the water valve opens to fill the ice maker, buzzing sounds may occur.
- Due to pressure equalizing when you open and close the refrigerator door, whooshing sounds may occur.



# Warranty (USA)

---

## WARRANTY ON SAMSUNG REFRIGERATOR

---

### LIMITED WARRANTY TO ORIGINAL PURCHASER

This Samsung brand product, as supplied and distributed by Samsung Electronics America, Inc. (Samsung) and delivered new, in the original carton to the original consumer purchaser, is warranted by Samsung against manufacturing defects in materials and workmanship for a limited warranty period of:

**One (1) year Parts and Labor on Refrigerator**

**Five (5) years Parts and Labor on sealed Refrigeration system only\***

**Ten (10) years Parts and Five (5) years Labor on Digital Inverter Compressor**

(\*Compressor, evaporator, condenser, drier, connecting tubing)

This limited warranty begins on the original date of purchase, and is valid only on products purchased and used in the United States. To receive warranty service, the purchaser must contact Samsung for problem determination and service procedures. Warranty service can only be performed by a Samsung authorized service center. The original dated bill of sale must be presented upon request as proof of purchase to Samsung or Samsung authorized service center.

Samsung will repair or replace any part found to be defective, at our option and at no charge as stipulated herein, with new or reconditioned parts during the limited warranty period specified above. All replaced parts and products become the property of Samsung and must be returned to Samsung. Replacement parts and products assume the remaining original warranty, or ninety (90) days, whichever is longer.

In-home service will be provided during the warranty labor period subject to availability within the contiguous United States. In-home service is not available in all areas. To receive in-home service, the product must be unobstructed and accessible from floor level to service personnel. If during in-home service repair cannot be completed, it may be necessary to remove, repair and return the product. If in-home service is unavailable, Samsung may elect, at our option, to provide for transportation of our choice to and from a Samsung authorized service center. Otherwise, transportation to and from the Samsung authorized service center is the responsibility of the purchaser.

This limited warranty covers manufacturing defects in materials and workmanship encountered in normal, noncommercial use of this product, and shall not apply to the following, including, but not limited to: damage which occurs in shipment; delivery and installation; applications and uses for which this product was not intended; altered product or serial numbers; cosmetic damage or exterior finish; accidents, abuse, neglect, fire, water, lightning or other acts of nature; use of products, equipment, systems, utilities, services, parts, supplies, accessories, applications, installations, repairs, external plumbing and leaks, external wiring, circuit breakers, fuses or connectors not supplied and authorized by Samsung, or which damage this product or result in service problems; incorrect electrical line voltage, fluctuations and surges; customer adjustments and failure to follow operating instructions, cleaning, maintenance and environmental instructions that are covered and prescribed in the instruction book; loss of food due to spoilage; consumable items including filters and light.

---

THERE ARE NO EXPRESS WARRANTIES OTHER THAN THOSE LISTED AND DESCRIBED ABOVE, AND NO WARRANTIES WHETHER EXPRESS OR IMPLIED, INCLUDING, BUT NOT LIMITED TO, ANY IMPLIED WARRANTIES OF MERCHANTABILITY OR FITNESS FOR A PARTICULAR PURPOSE, SHALL APPLY AFTER THE EXPRESS WARRANTY PERIODS STATED ABOVE, AND NO OTHER EXPRESS WARRANTY OR GUARANTY GIVEN BY ANY PERSON, FIRM OR CORPORATION WITH RESPECT TO THIS PRODUCT SHALL BE BINDING ON SAMSUNG. SAMSUNG SHALL NOT BE LIABLE FOR LOSS OF REVENUE OR PROFITS, FAILURE TO REALIZE SAVINGS OR OTHER BENEFITS, OR ANY OTHER SPECIAL, INCIDENTAL OR CONSEQUENTIAL DAMAGES CAUSED BY THE USE, MISUSE OR INABILITY TO USE THIS PRODUCT, REGARDLESS OF THE LEGAL THEORY ON WHICH THE CLAIM IS BASED, AND EVEN IF SAMSUNG HAS BEEN ADVISED OF THE POSSIBILITY OF SUCH DAMAGES. NOR SHALL RECOVERY OF ANY KIND AGAINST SAMSUNG BE GREATER IN AMOUNT THAN THE PURCHASE PRICE OF THE PRODUCT SOLD BY SAMSUNG AND CAUSING THE ALLEGED DAMAGE. WITHOUT LIMITING THE FOREGOING, PURCHASER ASSUMES ALL RISK AND LIABILITY FOR LOSS, DAMAGE OR INJURY TO PURCHASER AND PURCHASER'S PROPERTY AND TO OTHERS AND THEIR PROPERTY ARISING OUT OF THE USE, MISUSE OR INABILITY TO USE THIS PRODUCT SOLD BY SAMSUNG NOT CAUSED DIRECTLY BY THE NEGLIGENCE OF SAMSUNG. THIS LIMITED WARRANTY SHALL NOT EXTEND TO ANYONE OTHER THAN THE ORIGINAL PURCHASER OF THIS PRODUCT, IS NONTRANSFERABLE AND STATES YOUR EXCLUSIVE REMEDY.

Some states do not allow limitations on how long an implied warranty lasts, or the exclusion or limitation of incidental or consequential damages, so the above limitations or exclusions may not apply to you. This warranty gives you specific legal rights, and you may also have other rights, which vary from state to state. To obtain warranty service, please contact Samsung at:

### **SAMSUNG CUSTOMER CARE CENTER**

Samsung Electronics America, Inc.  
85 Challenger Road  
Ridgefield Park, NJ 07660  
1-800-SAMSUNG (726-7864)  
[www.samsung.com/us/support](http://www.samsung.com/us/support)

# Warranty Information (CANADA)

---

## If your refrigerator needs service

---

Do not hesitate to call any Samsung Authorized Service Center nearby giving them your name, address and telephone number if your product is not functioning properly.

## Limited Warranty for Original Purchaser

---

This Samsung product is warranted by Samsung Electronics Canada Inc. (hereafter referred to as SECA) against manufacturing defects in material or workmanship for the following periods:

Labor : 1 year (in-home)

Parts : 1 year

Inverter Compressor : 10 years (Part only)

SECA further warrants that if this product fails to operate properly within the specified warranty period and the failure is due to improper workmanship or defective material, SECA will repair or replace the product at its option. In-home service is not available in all areas. Contact us to find out if in-home service is currently available in your area by using the contact information at the back of this warranty.

All warranty repairs or part replacements must be performed by a SECA Authorized Service Center. (To find the nearest SECA Service Center, call 1-800-SAMSUNG (7267864) or visit our web site at [www.samsung.com/ca](http://www.samsung.com/ca))

## Obligation to the Original Owner

---

The original dated sales receipt must be retained by the customer and is the only acceptable proof of purchase. It must be presented to a SECA Authorized Service Center at the time service is requested before warranty services are rendered. On all carry-in models, transportation to and from the Authorized Service Center is the responsibility of the customer.

## Exclusions of the Warranty

---

This warranty does not cover damage due to accident, fire, flood, and/or other Acts of God, misuse, incorrect line voltage, improper installation, improper or unauthorized repairs, commercial use, or damage that occurs during shipping. Customer adjustments which are explained in this owners manual are not covered under the terms of this warranty. This warranty will automatically be voided for any unit found with a missing or altered serial number. This warranty is valid only on products purchased and used in the Canada.

---

## SAMSUNG CUSTOMER CARE CENTER

Samsung Electronics Canada Inc.  
2050 Derry Road West  
Mississauga, Ontario L5N 0B9  
Canada  
1-800-SAMSUNG (726-7864)  
[www.samsung.com/ca/support](http://www.samsung.com/ca/support) (English)  
[www.samsung.com/ca\\_fr/support](http://www.samsung.com/ca_fr/support) (French)



Scan this with your smartphone

Scan the QR code\* or visit  
[www.samsung.com/spsn](http://www.samsung.com/spsn)  
to view our helpful  
How-to Videos and Live Shows

\* Requires reader to be installed on your  
smartphone

## Contact SAMSUNG WORLD WIDE

If you have any questions or comments relating to Samsung products, please contact the SAMSUNG Customer Care Center.

Country	Contact Center	Web Site
U.S.A	1-800-SAMSUNG (726-7864) 1-844-SAM-PAYS (726-7297)	<a href="http://www.samsung.com/us/support">www.samsung.com/us/support</a>
CANADA	1-800-SAMSUNG(726-7864) 1-844-SAM-PAYS (726-7297)	<a href="http://www.samsung.com/ca/support">www.samsung.com/ca/support</a> (English) <a href="http://www.samsung.com/ca_fr/support">www.samsung.com/ca_fr/support</a> (French)



DA68-03570A-03

Universal Keywords: Div46 Src401 Samsung Mechtech

Document Specific Keywords: Owner's Manual

Date: 052217

Document Name: DA68-03570A-03

Subject: Samsung TM Refrigerator Owner's Manual

Models: RT18M6114SR/AA RT18M6213SG/AA RT18M6213SR/AA

RT18M6213WW/AA RT18M6215SG/AA RT18M6215SR/AA RT18M6215WW/AA

RT21M6213SG/AA RT21M6213SR/AA RT21M6213WW/AA RT21M6215SG/AA

RT21M6215SR/AA RT21M6215WW/AA RT18M6114SRAA RT18M6213SGAA

RT18M6213SRAA RT18M6213WWAA RT18M6215SGAA RT18M6215SRAA

RT18M6215WWAA RT21M6213SGAA RT21M6213SRAA RT21M6213WWAA

RT21M6215SGAA RT21M6215SRAA RT21M6215WWAA