



User manual



Single Phase 220-240V Systems:

iQool-SRC18HP	18,000 BTU Cassette unit
iQool-SRC24HP	24,000 BTU Cassette unit
iQool-SRC36HP	36,000 BTU Cassette unit

Three Phase 380-415V Systems:

iQool-SRC48HP	48,000 BTU Cassette unit
---------------	--------------------------

SMART WiFi CONTROLLED CEILING MOUNTED CASSETTE AIR CONDITIONER

Thank you for choosing an electriQ Air Conditioner
Please read this user manual before using this innovative
Air Conditioner and keep it safe for future reference.

Welcome to electriQ

We hope you're happy with your new purchase.

We'd love to see how you're getting on.

If you share any snaps on your socials,
make sure you tag us and use our hashtag.



@electriQUK
#electriQUK

We're here to help

Got a question or need help?

Get in touch with our friendly customer service team.



0330 390 3061
support@electriQ.co.uk
Mon - Fri | 9am to 5pm

**Unit 2A, Trident Business Park, Neptune Way,
Leeds Road, Huddersfield, HD2 1UA**

CONTENTS

SAFETY WARNINGS	4
ENERGY SAVING AND UNIT SAFETY PROTECTION TIPS	5
HOW SPLIT AIR CONDITIONERS WORK	6
SYSTEM DIAGRAM	7
PARTS LIST	9
INSTALLATION INFORMATION	10
HOW TO OPERATE YOUR AIR CONDITIONER	11
THE DISPLAY	11
SETTING UP THE REMOTE	11
QUICK START GUIDE	12
REMOTE CONTROL	13
UNDERSTANDING THE FUNCTIONS	15
IMPORTANT INFORMATION	18
SETTING UP THE WiFi APP	19
USING THE WiFi APP	24
CLEANING AND MAINTENANCE	29
TROUBLESHOOTING AND SELF DIAGNOSIS	31
TECHNICAL SPECIFICATION	34
SUPPORT	36

SAFETY WARNINGS

IMPORTANT!

- Carefully read the instructions before operating the unit
- This appliance comprises of an indoor cassette unit and an outdoor unit. The indoor unit is designed exclusively for indoor installations while the external condenser should be installed outside while still away from flood water or snow line.
- Always place the unit on a dry and stable surface. Install the outdoor unit on a wall with wall-mounting brackets or fix to a floor slab with special floor mounting slab bolts or brackets away from flood or snow lines.
- Rating: This unit must be only connected to a 220-240 V / 50 Hz earthed power source.
- Installation must be in accordance with the regulations of the country where the unit is used.
- This appliance is intended for permanent installation into a fixed structure, and should not be installed on vehicles.
- The outdoor part of the air conditioner unit must always be stored and transported upright, otherwise irreparable damage may be caused to the compressor; if in doubt we suggest waiting at least 24 hours before starting the unit.
- European Union regulations requires for an F-Gas trained engineer to handle any operation where non-qualified intervention could cause fluorinated gas to escape. A commissioning certificate must be issued with any installation.
- This air conditioner contains R32 which is a safe efficient refrigerant which has a lower environmental burden than traditional refrigerants.
- The refrigerant used in this air conditioner is an environmentally friendly hydrocarbon R32, which has a very low Global Warming Potential compared to traditional refrigerants.
- R32 is classed as slightly flammable and as such naked flames and sources of ignition should be kept a safe distance from the unit. If you are in any doubt about the suitability of your electrical supply have it checked and, if necessary, modified by a qualified electrician.
- This air conditioner has been tested and is safe to use. However, as with any electrical appliance - use it with care.
- Disconnect the power before dismantling, assembling or cleaning.
- Never connect the unit to an electrical outlet using an extension cord. Both the indoor cassette units and outdoor unit must be hardwired by a qualified electrician.
- Never operate this appliance if the cord is damaged. Ensure the power cord is not stretched or exposed to sharp objects or edges.
- A damaged supply cord should be replaced by the manufacturer or a qualified electrician in order to avoid a hazard.
- Avoid touching any moving parts within the appliance.
- Never insert fingers, pencils or any other objects through the guard.
- This appliance is not intended for use by persons (including children) with reduced physical, sensory or mental capabilities. It is also not intended for use by those with a lack of experience and knowledge, unless they have been given supervision or instruction concerning the use of the appliance by a person responsible for

SAFETY WARNINGS

their safety. Do not leave children unsupervised with this appliance.

- Do not clean the unit by spraying it or immersing it in water.
- Any service other than regular cleaning or filter replacement should be performed by an authorised service representative or a qualified air conditioning engineer. Failure to comply could result in a voided warranty.
- This air conditioner is intended for cooling / heating a room to a suitable level for human comfort, and should not be used for any other purpose such as cooling food.
- Avoid restarting the air conditioning unit unless 3 minutes have passed since being turned off. This prevents damage to the compressor.
- Never use the mains as a switch to start and turn off the air conditioning unit. Use the provided ON/OFF button located on the remote control.
- The indoor unit should not be installed in laundry or wet rooms.
- Diagrams and pictures provided within the manual are for guidance only. Due to continual product development, if there is any variance between the manual and the product received, the information provided on the product should be followed.



CAUTION: RISK OF FIRE



READ THE OPERATING
INSTRUCTIONS



READ THE TECHNICAL
MANUAL

ENERGY SAVING AND UNIT SAFETY PROTECTION TIPS

- Do not cover or restrict the airflow from the outlet or inlet grills.
- For maximum performance the minimum distance from a wall or objects should be 50cm.
- Keep the filters clean. Under normal conditions, filters should only need cleaning once every four weeks (approximately). Since the filters remove airborne particles, more frequent cleaning maybe necessary, depending on the air quality.
- For the initial startup set the fan speed to maximum and the thermostat to 4-5 degrees lower than the current temperature. After, set the fan switch to low and set the thermostat to your desired setting.
- To protect the unit we recommend not using the cooling mode when the ambient indoor temperature is higher than 35°C.
- To protect the unit we recommend not using the heating mode when the indoor ambient temperature is lower than 7°C. Performance will be reduced at lower temperatures.
- Note the manufacturer operating temperature ranges at the end of this user manual.

HOW SPLIT AIR CONDITIONERS WORK

COOLING MODE

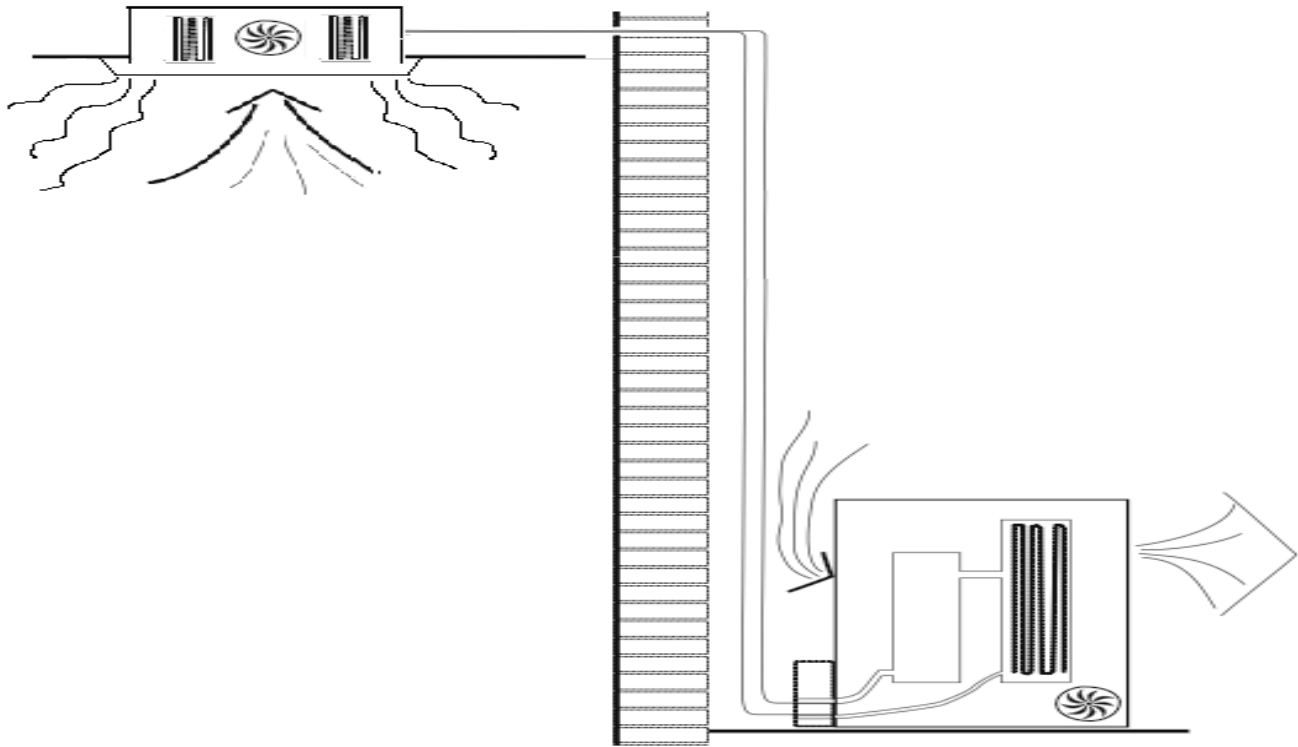

The compressor (6) in the external unit compresses the refrigerant into a high-temperature, high-pressure gas. When this gas flows along the cooling fins of the condenser (7), heat is exuded and the gas condenses into a liquid, which is then led to the evaporator (1) in the indoor unit. The liquid expands into a gas at a low temperature and low pressure. This gas absorbs the warmth of the air in the room, and a fan (3) draws the air through the filter and over the evaporator (1), blowing the cooled air back into the room. The heat is moved to the compressor along with the gas. A fan (8) draws air over the condenser and blows the warm air away.

- | | | |
|---------------|------------------|-------------------|
| 1. Evaporator | 2. Filter | 3. Evaporator Fan |
| 4. Gas Line | 5. Liquid line | 6. Compressor |
| 7. Condenser | 8. Condenser Fan | |

HEAT PUMP MODE

The system operates in reverse: the condenser works as an evaporator, the evaporator as a condenser: warm air is blown into the room. It is ideal as a maintenance heating when outside temperature is not too low and when the indoor temperature is more than 7°C.

DRY MODE

As with cooling, the moisture in the air condenses on the cold evaporator at room temperature acting as a powerful dehumidifier.

SYSTEM DIAGRAM

INDOOR

- 1 Air Outlet
- 2 Refrigerant pipes
- 3 Uplift Pump (Integrated)
- 4 Drainage Pipe
- 5 Air Return
- 6 Filter
- 7 Remote Control
- 8 Louvre for airflow
- 9 Refrigerant pipes
- 10 Interconnecting Cable
- 11 Wall Controller (Optional)

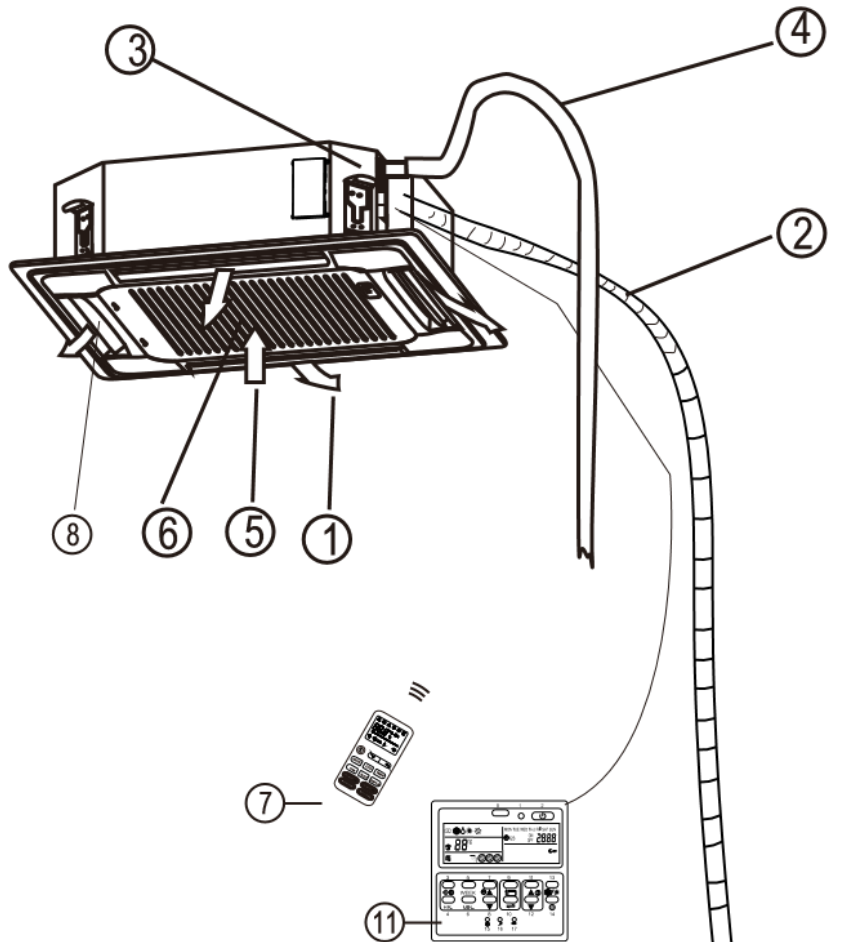

OUTDOOR UNIT

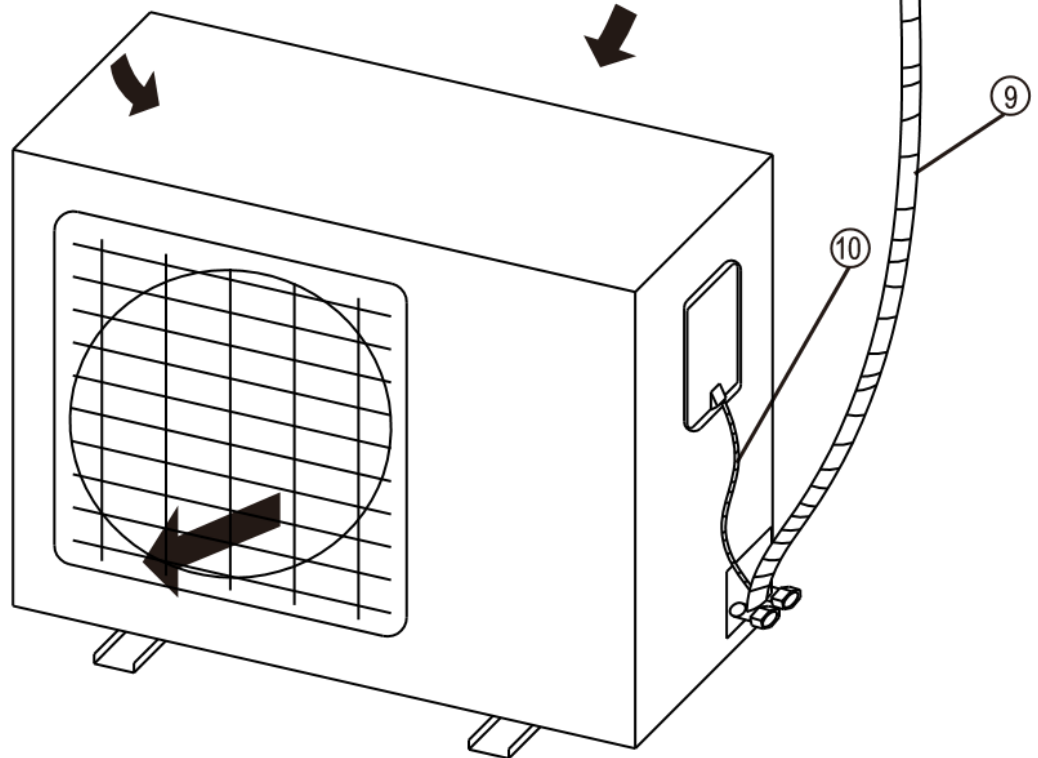

NOTE: DIAGRAMS FOR ILLUSTRATIVE PURPOSES ONLY

SYSTEM DIAGRAM

CASSETTE UNIT

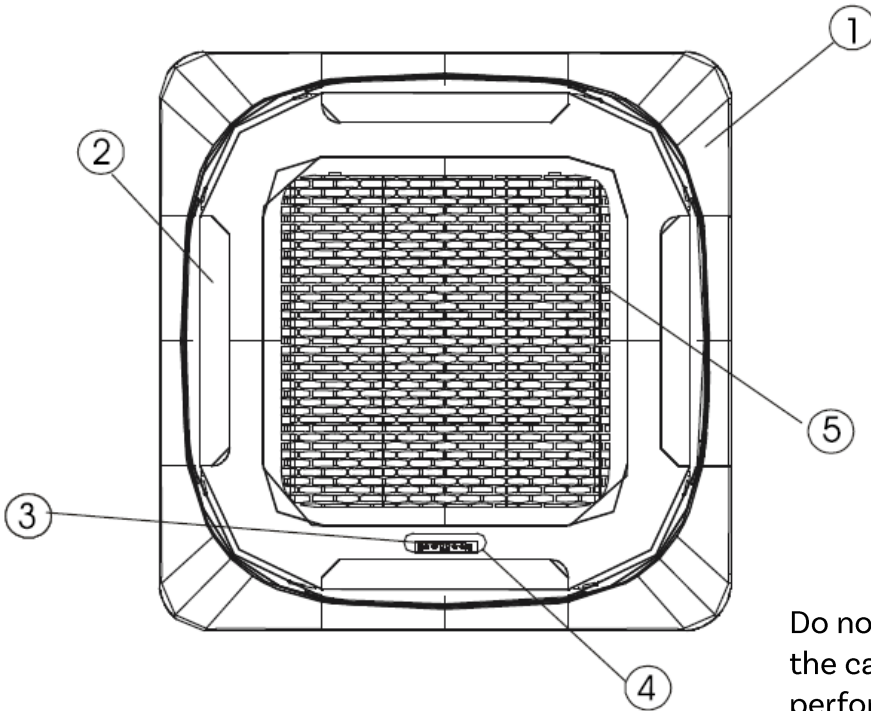

1.PANEL

2.AIR FLOW LOUVER

3.INFRARED SIGNAL RECEIVER

4.DISPLAY PANEL

5.AIR-Return GRILLE

Do not block the air inlets / outlets on the cassette, as this will reduce performance and may lead to damage.

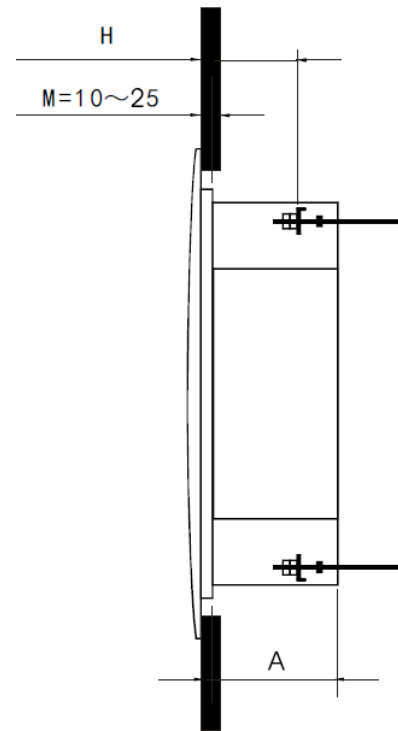
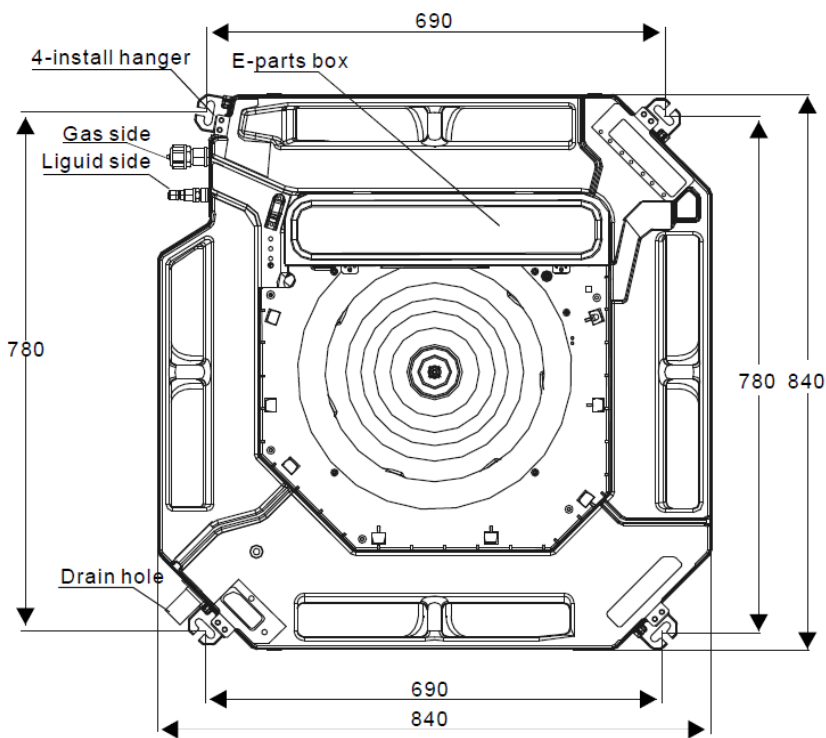

	A	H
iQool-SRC18HP	245	130-135
iQool-SRC24HP	245	130-135
iQool-SRC36HP	290	175-180
iQool-SRC48HP	290	175-180



PARTS LIST

OUTDOOR UNIT:

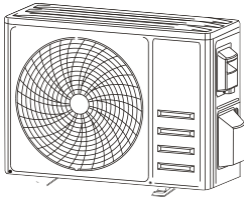

Outdoor Unit x 1



Installation Manual x 1



User Manual x 1



Drain Connector x 1



Rubber Feet Pads x 4
Not supplied with iQool-SRC48HP



Drainage pipe x 1

CASSETTE INDOOR UNIT:

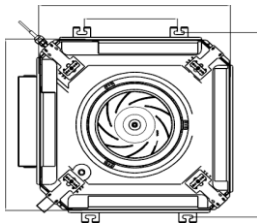

Cassette Unit x 1



Remote Control x 1



PVC Wrap x 2

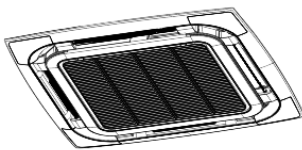

Panel x 1
(Packaged Separately)



Bolts x 4
(Packaged with Panel)
Not supplied with iQool-SRC48HP



5m Pipe kit x 1
(Packaged Separately)



5.5m Interconnecting Cable x 1
(Packaged with Pipe Kit)

NOTE: The items supplied may vary depending on the model purchased.

INSTALLATION INFORMATION

This air conditioner must be installed by qualified personnel following the requirements of the installation and service manual. Installation and servicing of the appliance must only be conducted by individuals possessing adequate backgrounds and qualifications in electrical, electronic, refrigerant and mechanical fields. Any attempt to install or repair the appliance may result in personal injury and property damage.

- Ensure you pass the service and installation manual onto the qualified engineer you have chosen to install this air conditioner.
- The manufacturer and retailer cannot be responsible for the interpretation of this information, nor can it assume any liability in connection with its use.
- The units are designed for permanent installation.
- The equipment is designed for domestic or office use and we are not making any endorsements for use in industrial or maritime environment.
- Do not place near sources of heat, vapours, industrial machine oil or other flammable gases.
- High-frequency waves generated by radio equipment, welders and medical equipment will interfere with the normal operation of the unit.
- Install this device only when it complies with local/national legislation, ordinances and standards.
- Check the mains voltage and frequency. This unit is only suitable for an earthed electrical supply,
iQool-SRC18HP, iQool-SRC24HP and iQool-SRC36HP: Connection voltage 220-240 V~ / 50 Hz.
iQool-SRC48HP: Connection voltage 380-415 V~ / 50 Hz / 3 Phase
- The information, specifications and parameter are subject to change due to technical modifications or improvement without any prior notice. The accurate specifications are presented on the nameplate label.
- Please read this installation manual completely before installing the product.
- When the power cord is damaged, replacement work shall be performed by authorised personnel only.
- Installation work must be performed in accordance with all European, national and / or local directives and standards and must be done by authorised personnel only.
- Always make sure to wear the correct personal safety protections such as protective eyewear, gloves, ear protection etc.
- This air conditioner contains a refrigerant and can be classified as pressurised equipment. Therefore always contact an authorised air conditioning engineer for installation and maintenance of the air conditioner.
- The air conditioner must be inspected and serviced on an annual basis by an authorised air conditioning engineer.







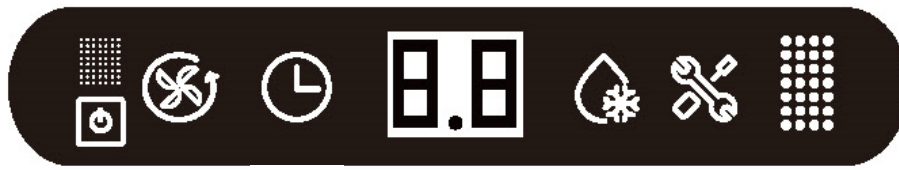

This air conditioner also supports the addition of an optional wired controller model number: IQOOL-WIREDCASCTRL

Please refer to the manual for the controller for guidance on its operation.

HOW TO OPERATE YOUR AIR CONDITIONER

THE DISPLAY



Buzzer		Nixie tube	
Manual Switch		Defrosting/preheat light	
Running Light		Warning light	
Timing Light		Infrared Signal receiver	

NOTE: All diagrams and images are for illustrational purposes only as the item is subject to continual improvement.



MANUAL SWITCH	Can be used to turn the air conditioner on and off
RUNNING LIGHT	Will illuminate when the cassette unit is operating
TIMER LIGHT	Will illuminate when the timer is set
WARNING LIGHT	Will illuminate when an error is detected
PRE-HEAT/DEFROST LIGHT	Will illuminate when the indoor unit is heating the coils, before warm air is expelled in heating mode, or to prevent frost in cooling mode.

SETTING UP THE REMOTE

Insert 2 x AAA batteries into the rear of the remote control. When batteries are first inserted or following changing the batteries, the remote must be set up for the type of air conditioner, either COOLING AND HEATING or COOLING ONLY.

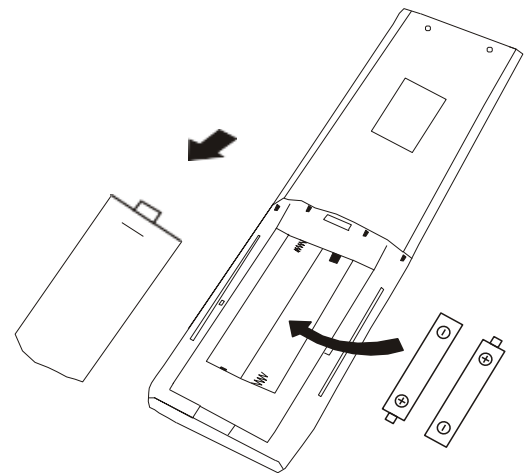
As soon as the batteries are inserted, press and hold the MODE button on the remote until the correct icon is displayed:



	COOLING ONLY
	HEATING AND COOLING

If COOLING ONLY is selected, the Heating mode will be deactivated.





If the remote is set up for the wrong type of unit, simply remove the batteries and reinsert, before following the step above.

The remote control has a range of up to 8m. Point the remote control at the receiver in the interior unit. A beep confirms that the remote-control signal has been received.

HOW TO OPERATE YOUR AIR CONDITIONER

QUICK START GUIDE

1. With the remote control pointed at the indoor cassette unit, turn the appliance on using the **ON/OFF** button on the remote control.
2. Repeatedly press the **MODE** button to select the desired mode. The display on the remote will show the symbol to indicate the currently selected mode:

	Auto Mode
	Cooling Mode
	Dry Mode
	Fan only Mode
	Heating Mode

3. Use the **FAN** button to select the fan speed. The fan speed indicator on the remote will show the currently selected fan speed (5 speeds + Auto):



4. Use the \wedge and \vee buttons to select the desired room temperature. The temperature selected will be displayed both on the remote and the front panel of the indoor unit.

HOW TO OPERATE YOUR AIR CONDITIONER

THE REMOTE CONTROL



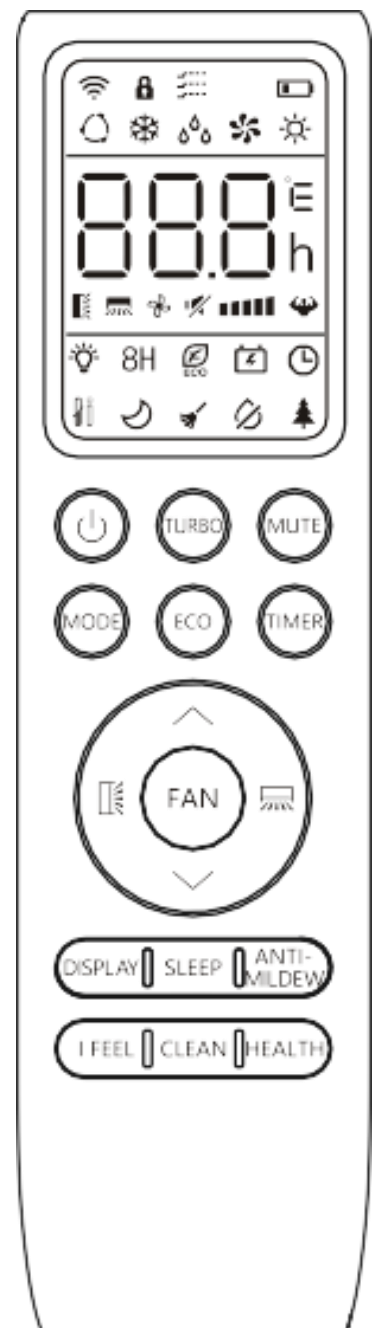

SYMBOL	MEANING
	Battery indicator
	Auto Mode
	Cooling Mode
	Dry Mode
	Fan only Mode
	Heating Mode
	ECO Mode
	Timer
	Temperature indicator
	Fan speed: Auto/low/low-mid/mid/mid-high/high
	Mute function
	TURBO function
	Vertical auto swing
	Horizontal auto swing
	SLEEP function
	Health function (Not Applicable to these models)
	I FEEL function
	8°C heating function
	Signal indicator
	Gentle breeze
	Child-Lock
	Display ON/OFF
	Self-Clean function (Not Applicable to these models)
	Anti-Mildew



*The functions available on the remote varies depending on the specification and features of the model of air conditioner purchased.

HOW TO OPERATE YOUR AIR CONDITIONER

BUTTONS



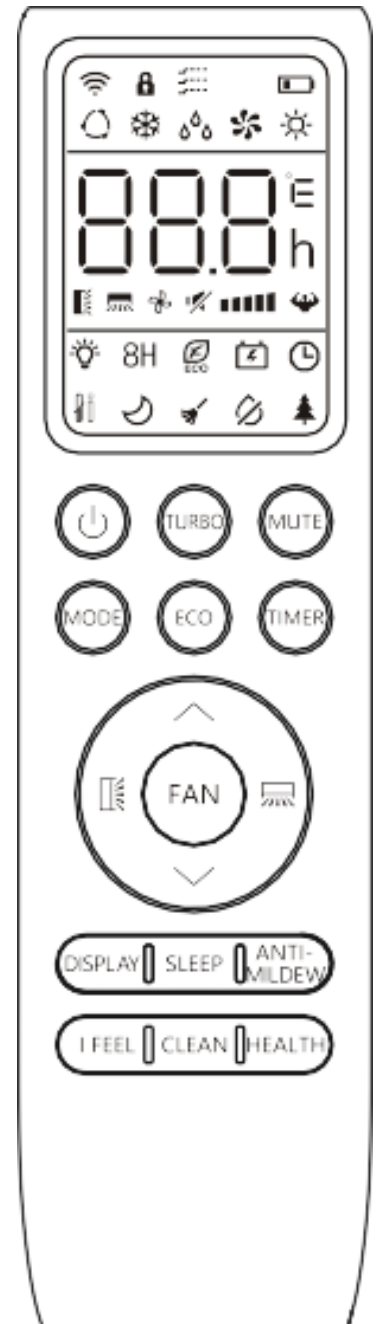



SYMBOL	FUNCTION
	Press to turn the air conditioner on and off
	Press to increase the desired temperature, or set the Timer.
	Press to decrease the desired temperature, or set the Timer.
	Press to stop or start vertical swing. Used to set the vertical airflow direction.
	Press to stop or start horizontal swing. Used to set the horizontal airflow direction.
FAN	Press to select the fan speed between: auto/mute/low/low-mid/mid/mid-high/high/turbo.
TURBO	Press to activate/deactivate the TURBO function.
	Press and hold to change between displaying temperatures in Celsius and Fahrenheit.
MUTE	Press to activate/deactivate the MUTE function.
MODE	Press to select the mode between: AUTO, COOL, DRY, FAN and HEAT.
ECO	Press to activate/deactivate the ECO function.
	Press and hold to activate/deactivate the 8°C heating function.
TIMER	Press to set an On/Off timer.
DISPLAY	Press to turn the display on and off.
SLEEP	To switch-on/off the function SLEEP.
ANTI-MILDEW	To activate/deactivate the ANTI-MILDEW function.
I FEEL	To switch-on/off the I FEEL function.
CLEAN	Not used on these models
HEALTH	Not used on these models
BUTTON COMBINATIONS	
MODE + TIMER	Press together to activate/deactivate the CHILD-LOCK function.
FAN + MUTE	To activate/deactivate the GENTLE BREEZE function.















*The functions available on the remote varies depending on the specification and features of the model of air conditioner purchased.

See the following pages for more detailed information on the functions





UNDERSTANDING THE FUNCTIONS

		MODES							
		Icon	Function						
MODES		COOLING	Cools the room when the room temperature is above the desired temperature set. It will also help reduce humidity at the same time.						
		<ol style="list-style-type: none"> 1. Press the MODE button until the COOL indicator appears. 2. Set the desired room temperature using the \wedge and \vee buttons (16 - 31°C) 3. Use the FAN button to set the fan speed. 							
		HEATING	Heats the room when the room temperature is below the desired temperature set.						
		<ol style="list-style-type: none"> 1. Press the MODE button until the HEAT indicator appears. 2. Set the desired room temperature using the \wedge and \vee buttons (16 - 31°C) 3. Use the FAN button to set the fan speed. 							
		DRY	Removes moisture from the air, by creating a cold surface within the indoor unit for moisture to condensate on.						
		<ol style="list-style-type: none"> 1. Press the MODE button until the DRY indicator appears. <p>The fan speed will always be low in this mode and the fan speed and temperature cannot be adjusted in dry mode</p>							
	FAN	Helps air circulation within the room while acting as a fan, with no heating or cooling function.							
	<ol style="list-style-type: none"> 1. Press MODE button until the FAN indicator appears. 2. Use the FAN button to set the fan speed, cycling through AUTO, MUTE, LOW, LOW-MID, MID, MID-HIGH, HIGH and TURBO 								
	AUTO	The operating mode will automatically be selected depending on the room temperature, and aims for a room temperature of 23°C.							
	<ol style="list-style-type: none"> 1. Press the MODE button until the AUTO indicator appears. 2. The room temperature determines how the air conditioner operates. It is not possible to change the temperature in this mode the unit will operate to achieve best performance. The operation logic is as below: <table border="1" data-bbox="582 1189 1270 1346"> <thead> <tr> <th>Ambient Temperature</th> <th>Operation Mode</th> </tr> </thead> <tbody> <tr> <td><20°C</td> <td>Heating</td> </tr> <tr> <td>20°C - 26°C</td> <td>Dry</td> </tr> <tr> <td>>26°C</td> <td>Cool</td> </tr> </tbody> </table> 3. Use the FAN button to set the fan speed. 		Ambient Temperature	Operation Mode	<20°C	Heating	20°C - 26°C	Dry	>26°C
Ambient Temperature	Operation Mode								
<20°C	Heating								
20°C - 26°C	Dry								
>26°C	Cool								
TIMER		OFF TIMER	Set while the air conditioner is running, so it turns off after the period of operation set.						
		<ol style="list-style-type: none"> 1. With the air conditioner running, press the TIMER button. 2. Use the \wedge and \vee buttons to set the duration (max 24 hours). 3. Press the TIMER button to confirm. <p>Once the running time has elapsed, the appliance will switch itself off. To cancel the timer function before the set time has elapsed, press the TIMER button again.</p>							
		ON TIMER	Set while the air conditioner is in standby, so it turns on after the period set and operates with the previous settings.						
		<ol style="list-style-type: none"> 1. With the air conditioner in standby, press the TIMER button. 2. Use the \wedge and \vee buttons to set the duration (max 24 hours). 3. Press the TIMER button to confirm. 4. The operating parameters can then be adjusted using the \wedge and \vee, MODE and FAN buttons. <p>Once the running time has elapsed, the appliance will start operating. To cancel the timer function before the set time has elapsed, press the TIMER button again.</p>							

UNDERSTANDING THE FUNCTIONS

SWING		VERTICAL	The outer flap on the unit will slowly move up and down to alter the vertical direction of the airflow.
			<ol style="list-style-type: none"> 1. Press the  button to start the vertical swing. 2. Press the  button again to stop the flap in its current position.
SWING		HORIZONTAL	The inner louvres on the unit will slowly twist left and right to alter the horizontal direction of the airflow.
			<ol style="list-style-type: none"> 1. Press the  button to start the horizontal swing. 2. Press the  button again to stop the internal louvres in their current position.
ADDITIONAL FUNCTIONS		TURBO	Operates at highest fan speed for 15 minutes to maximise performance, when heating or cooling a room.
			<ol style="list-style-type: none"> 1. Press the TURBO button to activate turbo mode 2. The fan and compressor will run at maximum speed for 15 minutes, before returning to their previously set levels. <p>To cancel turbo mode, press the TURBO button again.</p>
		MUTE	Operates at lowest fan speed to minimise the operating noise of the indoor unit.
			<ol style="list-style-type: none"> 1. Press the MUTE button to activate the function. 2. Press the MUTE button again to deactivate the function
		ECO	Automatically adjusts the settings to reduce energy usage.
			<ol style="list-style-type: none"> 1. Press the ECO button to activate the function. 2. Press the ECO button again to deactivate the function
		SLEEP	Operates at lowest fan speed to minimise the operating noise of the indoor unit for 10 hours, before returning to normal operation.
			<ol style="list-style-type: none"> 1. Press the SLEEP button to activate the function. <p>The function will automatically stop after 10 hours, but can be cancelled earlier by pressing the SLEEP button.</p>
	ANTI-MILDEW	The indoor unit will operate in fan mode for 15 minutes to remove any moisture, before turning off.	
		<ol style="list-style-type: none"> 1. Press the ANTI-MILDEW button to activate the function. <p>The function will automatically stop after 15 minutes.</p>	
	I FEEL	The room temperature is measured by the remote control instead of the indoor unit, allowing you to optimise the temperature to ensure comfort.	
		<ol style="list-style-type: none"> 1. Press the I FEEL button to activate the function. 2. Press the I FEEL button again to deactivate the function 	
	8°C HEATING	A 30 minute program designed to remove dirt and bacteria from within the indoor unit.	
		<ol style="list-style-type: none"> 1. Press and hold the ECO button for 3 seconds to enter the mode. <p>Press and hold the ECO button for 3 seconds to exit the mode.</p>	

UNDERSTANDING THE FUNCTIONS

ADDITIONAL SETTINGS / FEATURES		CHILD LOCK	Locks the buttons on the remote to prevent the accidental alteration of settings.
			<ol style="list-style-type: none"> 1. Press the MODE and TIMER buttons together to activate the function 2. Press them again to cancel the function.
		GENTLE BREEZE	Operates with the flap on the indoor unit closed, to provide a gentle breeze into the room.
			<ol style="list-style-type: none"> 1. Press the FAN and MUTE buttons together to activate the function 2. Press them again to cancel the function.
	°C/° F	TEMP UNIT	Change the temperature that displays on the remote and unit between Celsius and Fahrenheit.
			<ol style="list-style-type: none"> 1. Hold the TURBO button for 5 seconds to change the temperature display 2. Repeat to change back.
		WiFi SETUP	Used to connect the indoor unit to your SMART app. Each indoor should be set up separately
			There are 3 options for activating the WiFi setup, as shown below. For more detail see the WiFi connection section of this manual.
		Method 1	<ol style="list-style-type: none"> 1. Press the DISPLAY button 6 times within 8 seconds. The unit will then bleep 3 times and CF or AP will be shown on the indoor display.
		Method 2	<ol style="list-style-type: none"> 1. Press the ECO button 6 times within 8 seconds. The unit will then bleep 3 times and CF or AP will be shown on the indoor display.
	Method 3	<ol style="list-style-type: none"> 1. Press and hold the MODE and ^ buttons for 3 seconds. The unit will then bleep 3 times and CF or AP will be shown on the indoor display.	
	FAN SPEED	In most modes the fan speed can be adjusted.	
		<ol style="list-style-type: none"> 1. Press the FAN button to change between the fan speeds, the available options are: auto, mute, low, low-mid, mid, mid-high, high, turbo 	
	BATTERY LEVEL	The remote will show you the current battery level	
		When the battery level is showing as low, the batteries in the remote control should be changed, to ensure you can continue to operate the air conditioner.	

HOTEL MENU (IQOOL-SRC48HP ONLY)

The IQOOL-SRC48HP has an additional HOTEL mode, which allows features to be restricted and alteration to be made to operation. To enter the setup, within 20 seconds of inserting the batteries into the remote, press the power button, followed by holding the FAN and DOWN buttons for 5 seconds. The remote will then display E1. Within this menu use the UP and DOWN buttons to navigate/ change values, FAN to select, and MODE to confirm.

CODE	DESCRIPTION	PARAMETERS
E1	Auto Start following power failure	ON / OFF
E2	Swing Memory Function	ON / OFF
E3	Cooling and Heating Mode (Set the unit as cooling only or heating only)	CC / CH / HH
E4	Minimum temperature	16 to 25
E5	Maximum Temperature	26 to 31
E6	Dry Contact delay time (minutes)	0 to 6
E7	Dust Filter Clean Reminder	ON / OFF
E8	Heating temperature compensation	0 to 6
E9	Cooling temperature compensation	0 to 6
F1	Modbus Address Control (to allow connection to Centralized control unit)	00 to FF

UNDERSTANDING THE FUNCTIONS

IMPORTANT INFORMATION

HEATING MODE

When the air conditioner is placed in heating mode, the indoor unit will appear to be inactive while it follows its pre-heat procedure to heat the evaporator coils. Once the coils have heated, the indoor fan will start to run. This process usually takes 1 – 3 minutes, and is designed to ensure that cold air is not circulated.

During heating mode, the appliance can automatically activate a defrost cycle, which is essential to clean the frost on the condenser so as to recover its heat exchange function. This procedure usually lasts for 2-10 minutes. During defrosting, the fan in the indoor unit will stop operation. After defrosting, it will return to HEATING mode automatically.

AUTO RESTART

The air conditioner will automatically restart when electricity is restored after a power cut. If in doubt, check the settings.

RANGE OF INTERNAL THERMOSTAT

The internal thermostat can be set at a desired temperature between 16 and 31°C. Note that whether the desired value is achieved depends on the room size, temperature and insulation of the room.

RANGE OF HEAT PUMP FUNCTION

The heat function can be used when the external ambient temperature is above -20°C. The performance of the heat pump will degrade with lowering external temperatures. Please note the performance will reduce when the outdoor temperature drops below 5°C.

CAPACITY

The required cooling or heating capacity depends greatly on the location and/or use of the room where the air conditioner is installed. Strong sunlight and the presence of people, lights or equipment creates an additional heat load. Normal living spaces require about 350 Btu per square meters of floor surface. In strong sunlight or if other sources of heat are present, this may be as much as 1200 Btu per sqm.

Tip: On warm days, let the air conditioner cool the room as much as possible during the night and keep the temperature constant from night to daytime.

SETTING UP THE WiFi APP

BEFORE YOU START

- Ensure your router provides a standard 2.4ghz connection.
- If your router is dual band ensure that both networks have different network names (SSID). The provider of your router / Internet service provider will be able to provide advice specific to your router.
- Ensure the router is as close as possible to the indoor unit during setup.
- Once the app has been installed on your phone, turn off the data connection, and ensure your phone is connected to your router via WIFI.

DOWNLOAD THE APP TO YOUR PHONE

Download the "SmartLife" app, from your chosen app store, using the QR codes below, or by searching for the app in your chosen store.



Android



IOS

The unit can also be controlled using the "Tuya Smart" app which is also available in the app stores. We would advise on using the version above which is optimised for use with your air conditioner as we cannot guarantee the correct functionality of all features when other versions are used.



Android



IOS

SETTING UP THE WiFi APP

CONNECTION METHODS AVAILABLE FOR SETUP

The air conditioner has two different setup modes, Quick Connection and AP (Access Point). The quick connection is a quick and simple way to set the unit up. The AP connection uses a direct local WiFi connection between your phone and the air conditioner to upload the network details.

Please ensure your device is in the correct WiFi connection mode for the connection type you are attempting, the flashing of the WiFi light on your air conditioner will indicate this.

CONNECTION TYPE	DISPLAY OF INDOOR UNIT SHOWS
Quick Connection	CF
AP (Access Point)	AP

RESETTING THE WiFi CONNECTION ON THE INDOOR UNIT

There are 3 different methods for resetting the WiFi module on the indoor unit, which can be done using your mobile phone:

Method 1	Press the DISPLAY button 6 times within 8 seconds.
Method 2	Press the ECO button 6 times within 8 seconds.
Method 3	Press and hold the MODE and ^ buttons for 3 seconds.

Once the above has been followed, it will bleep 3 times, you should allow upto 10 seconds for the connection mode to be displayed on the indoor unit before continuing connection.

If no connection is made within 2 hours, the WiFi will automatically turn off, and the connection should be reset following the steps above to reactivate the function.

Please note: Each indoor unit is classed as a separate device within the app and as such the connection process should be repeated for each indoor unit.

CHANGING BETWEEN CONNECTION TYPES

Changing the air conditioner between the two WiFi connection modes is exactly the same process as resetting the connection:

Method 1	Press the DISPLAY button 6 times within 8 seconds.
Method 2	Press the ECO button 6 times within 8 seconds.
Method 3	Press and hold the MODE and ^ buttons for 3 seconds.

SETTING UP THE WiFi APP

REGISTER THE APP

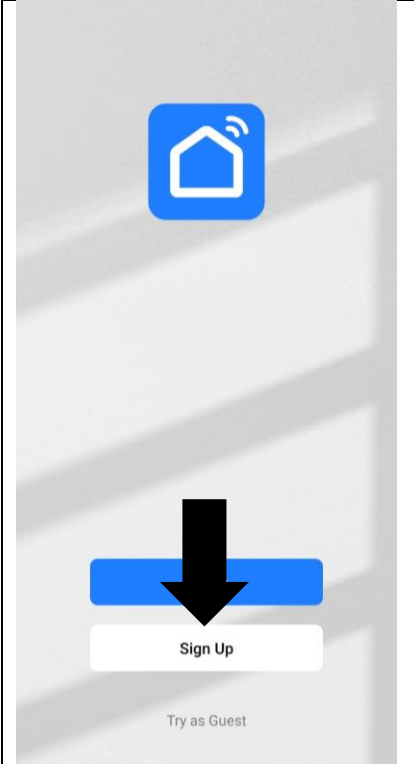
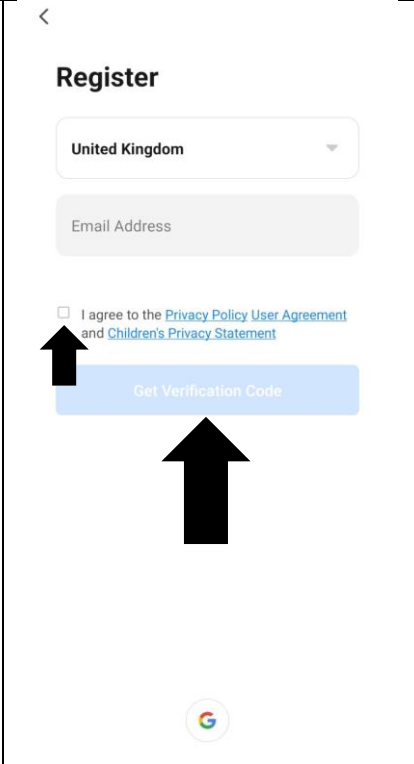
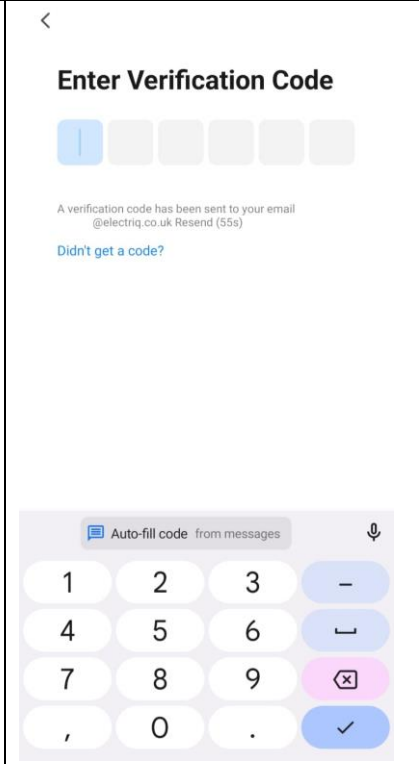
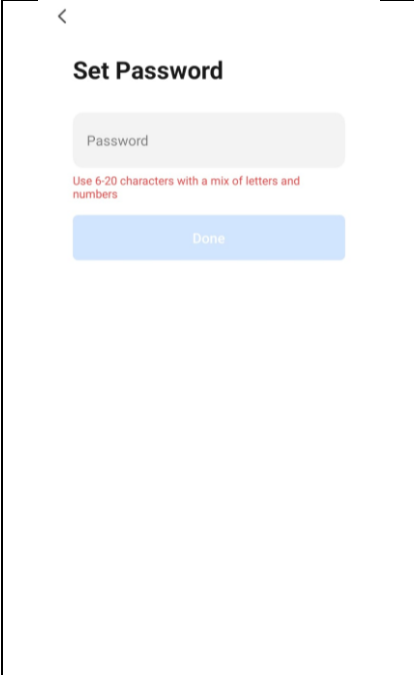
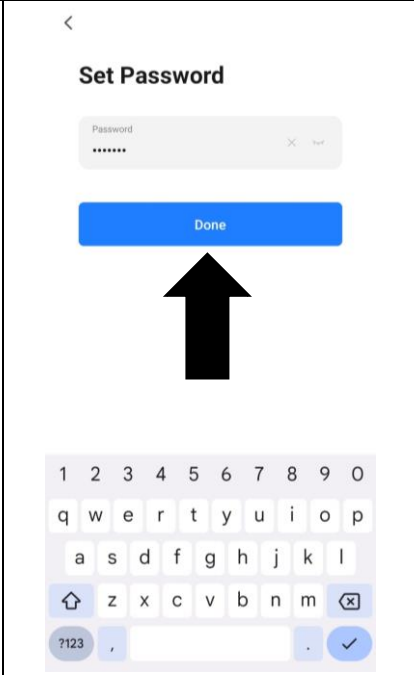
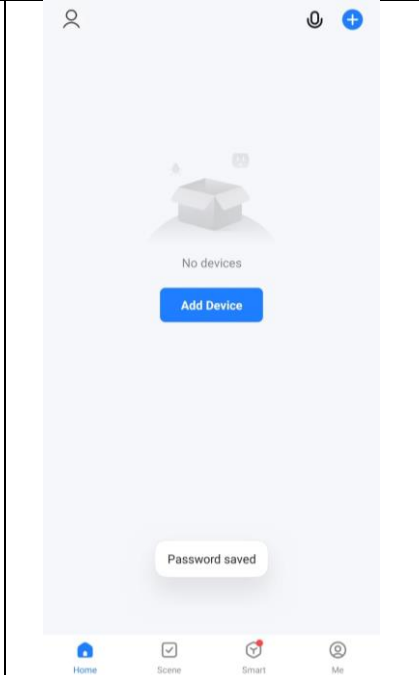

Upon the first use, an account will need to be registered which can be done as below:

<p>1 Press the Sign Up button at the bottom of the screen.</p>	<p>2 Change the country (If required) before entering your email address, ticking the checkbox, and pressing the Get Verification Code button.</p>	<p>3 A verification code will be sent to your email address. Type it into the boxes.</p>
		
<p>4 Create a password following the requirements.</p>	<p>5 Once it has been entered, press Done.</p>	<p>6 The app will then load to the main device screen.</p>
		

SETTING UP THE WiFi APP

CONNECTING USING QUICK CONNECTION MODE

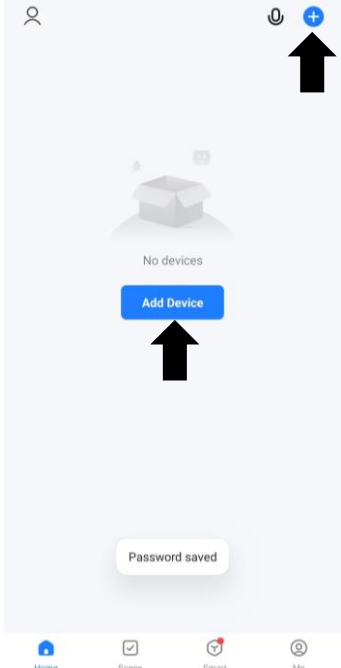
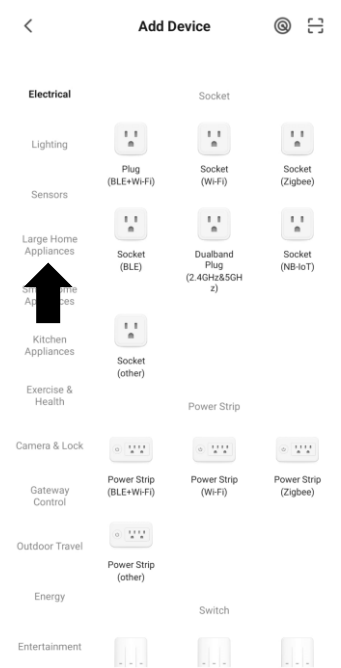

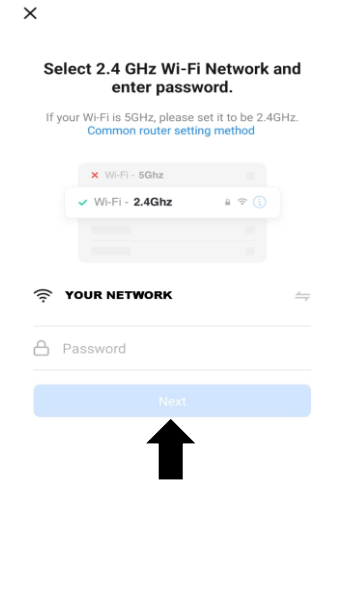
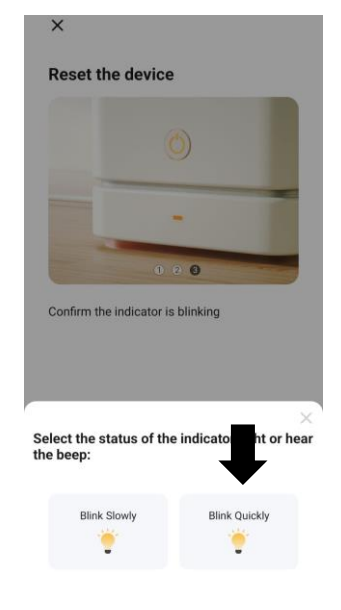
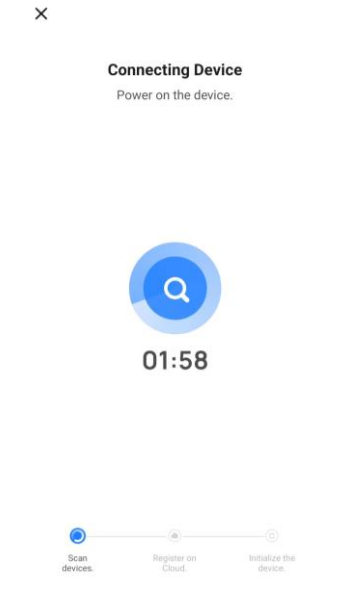
Before initiating the connection, make sure the unit is in standby mode, with the display on the indoor unit showing CF. If not follow the instructions for changing the connection mode. You should also ensure your phone is connected to the WiFi network. (We advise turning mobile data off during setup)

<p>1 Press on Add Device, or the + in the top right corner.</p>	<p>2 Press the Large Home Appliances tab on the left</p>	<p>3 Press on Air Conditioner (WiFi)</p>
		
<p>4 Ensure your WiFi network is shown before entering your password*, and pressing Next.</p>	<p>5 As you have already prepared your air conditioner, Press Next On the screens asking to Reset the device. Then select Blink Quickly.</p>	<p>6 The app will now attempt to connect your air conditioner to the internet.</p>
		
<p>7 Once successfully added the app will take you to the device screen. If connection fails, retry connection using the quick connection (CF) mode, or alternatively follow the Access Point (AP) mode connection method.</p>		

SETTING UP THE WiFi APP

CONNECTING USING ACCESS POINT (AP) MODE

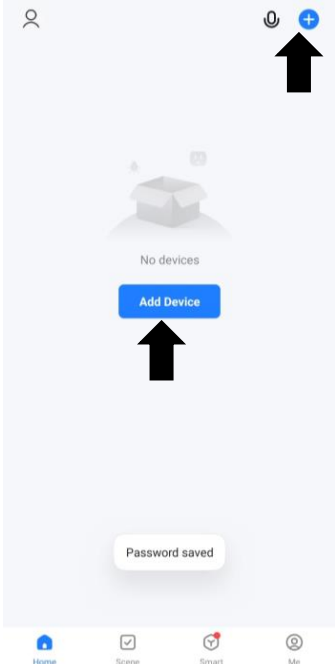
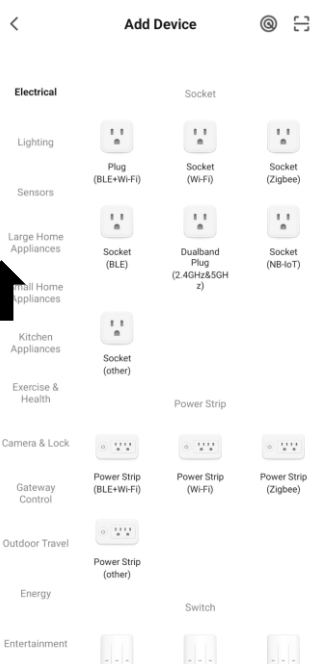
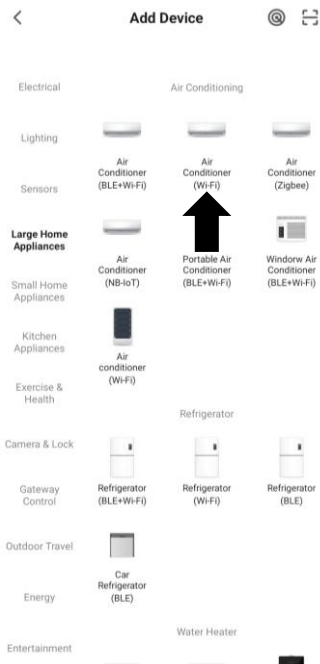
Before initiating the connection, make sure the unit is in standby mode, with the display on the indoor unit showing AP. If not follow the instructions for changing the connection mode. You should also ensure your phone is connected to the WiFi network. (We advise turning mobile data off during setup)

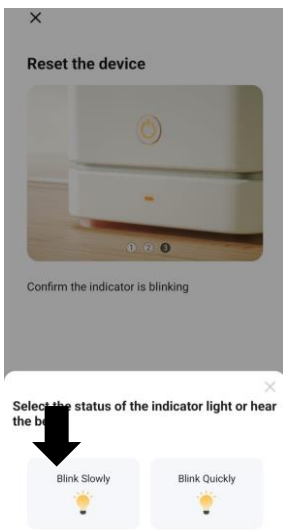
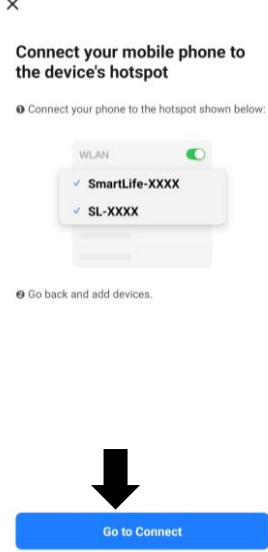
<p>1 Press on Add Device, or the + in the top right corner.</p>	<p>2 Press the Large Home Appliances tab on the left</p>	<p>3 Press on Air Conditioner (WiFi)</p>
		
<p>4 Ensure your WiFi network is shown before entering your password*, and pressing Next.</p>	<p>5 As you have already prepared your air conditioner, Press Next on the screens asking to reset the device. Then select Blink Quickly.</p>	<p>6 Use the Go to connect button to leave the app, and connect your phone to the WiFi hotspot created by the air</p>
		
<p>6</p>	<p>Return to the app and it will attempt to connect your air conditioner to the internet.</p>	
<p>7</p>	<p>Once successfully added the app will take you to the device screen. If connection fails, retry connection using the Access Point (AP) mode, or alternatively follow the Quick Connection (CF) mode connection method.</p>	

* Passwords are case sensitive, and often on a label attached to your router.

Instructions are for guidance only, due to continual development of the app, the process may differ from the above.



SETTING UP THE WiFi APP

THE HOME SCREEN

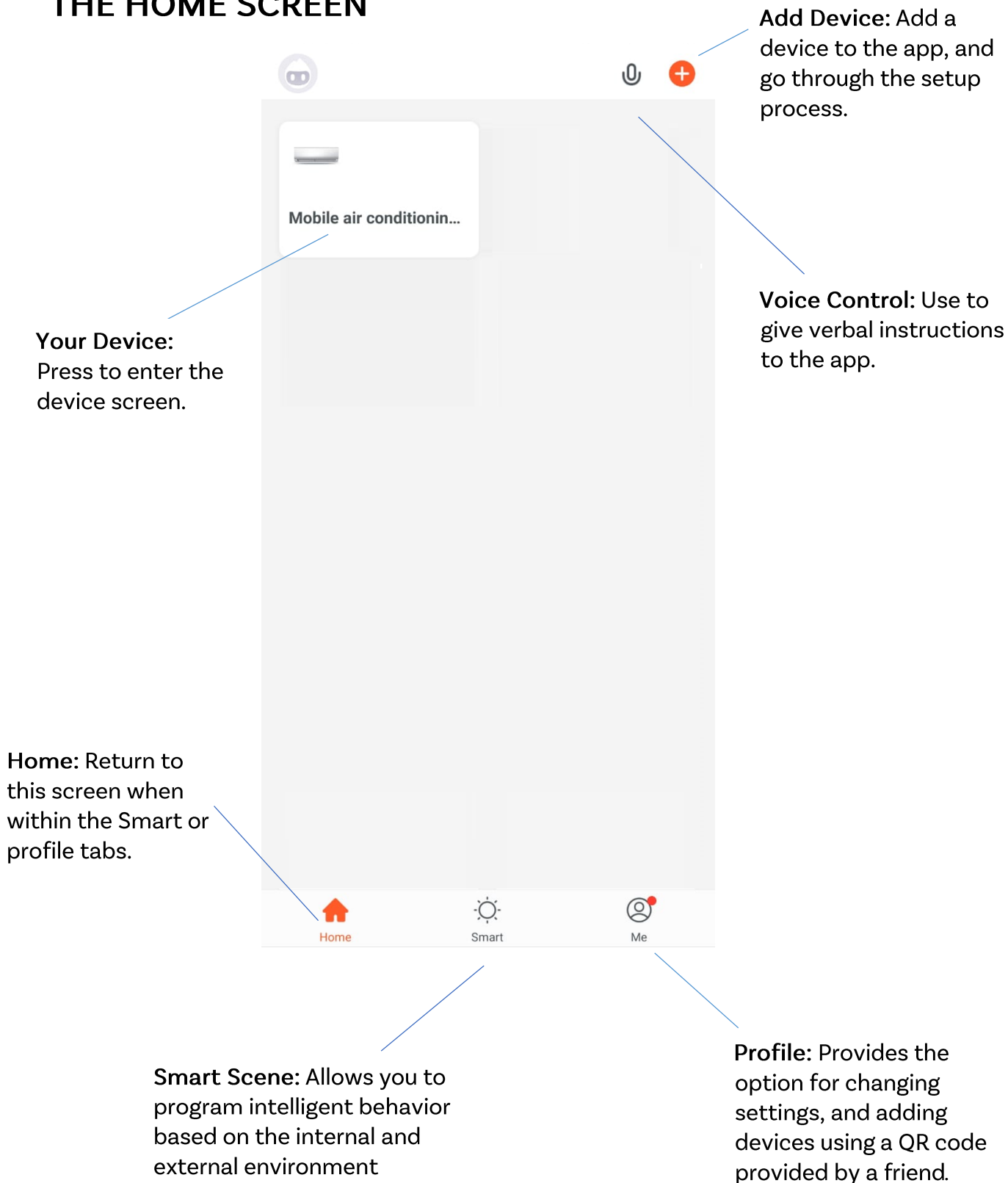

Each device has its own entry on the home screen to allow the user to either quickly turn the unit on or off, or to enter the device screen to make other changes.

SETTING UP THE WiFi APP

THE DEVICE SCREEN

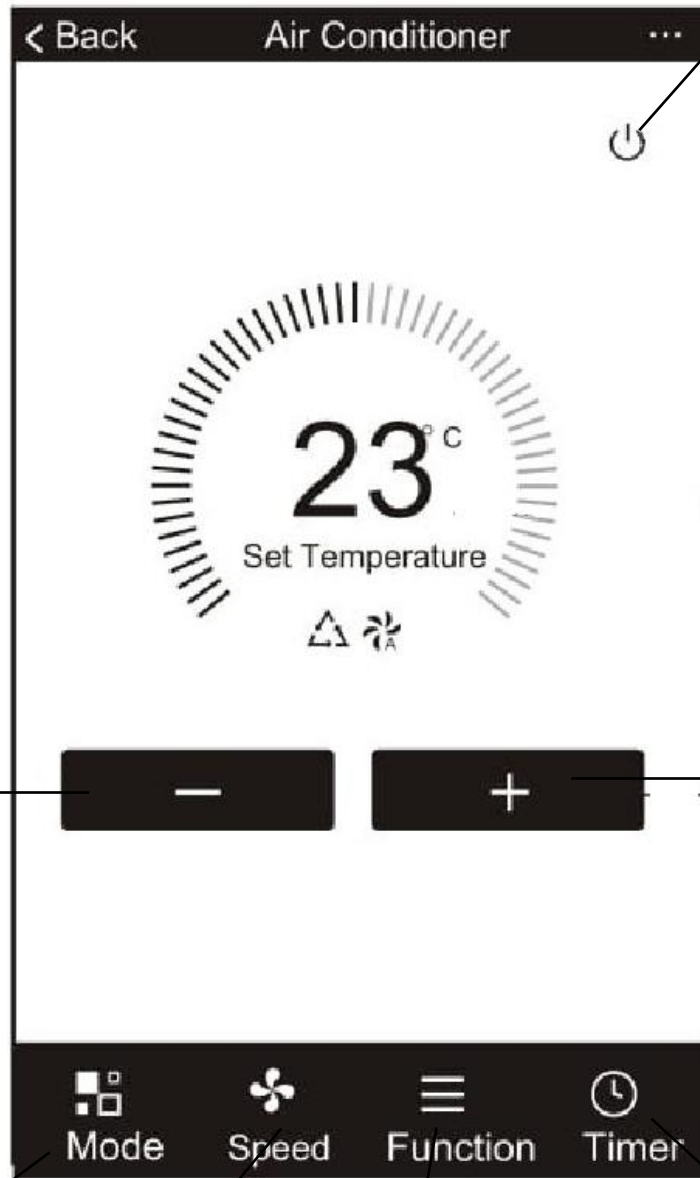

Turn Indoor unit on and off

Decrease desired room temperature

Increase desired room temperature

Change between Auto, Cool Heat, Dry and Fan modes.

Adjust the fan speed.

Activate additional functions such as Swing, Turbo, Sleep and Eco Mode

Set an off or on timer.

SETTING UP THE WiFi APP

SMART SCENES

Smart Scenes is a powerful tool providing the option to customise the operation of the air conditioner based both on conditions within the room and outside influences. This gives the user the option of specifying much more intelligent actions. These are split into two categories Scene and Automation.

SCENE

Scene allows for a one touch button to be added to the Home screen. The button can be used to change a number of settings in one go, and can change all the settings within the unit. A number of scenes can easily be setup, allowing the user to easily change between a number of preset configurations.

Below is an example of how to set up a scene:

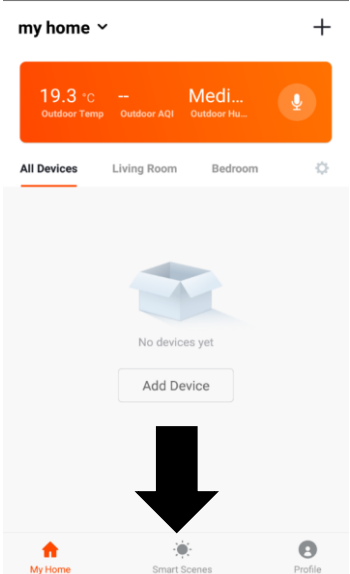
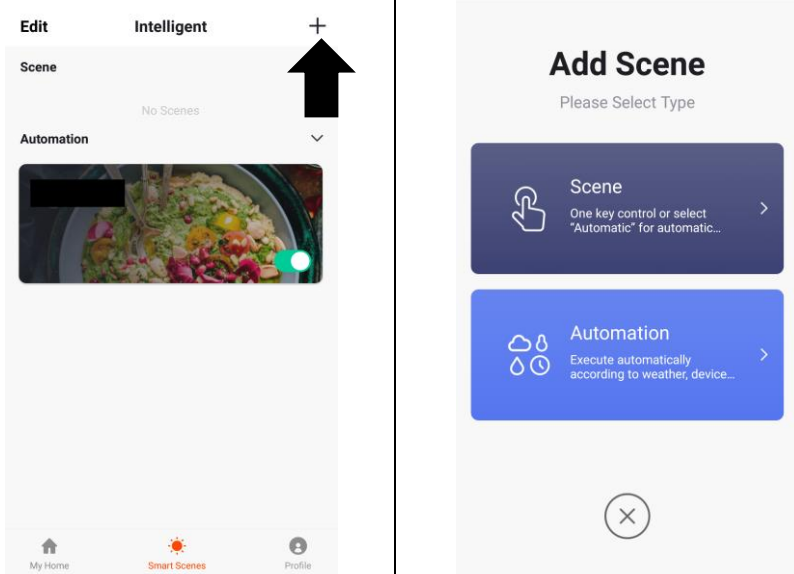
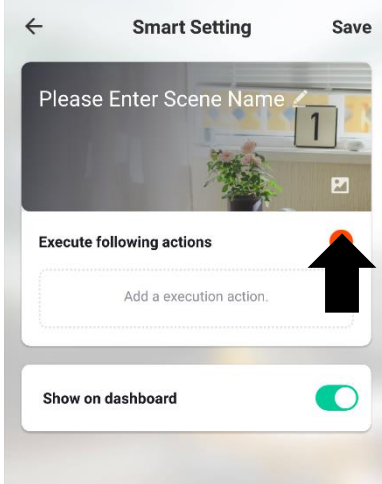
1	Press the Smart Scene tab at the bottom of the Home screen	2	Press the + in the top right corner to add a smart scene.
			
4	<p>Press the Pen next to Please Enter Scene Name to input the name for your Scene.</p> <p>Show on Dashboard: Leave this on if you require the scene to be displayed as a button on the Home Screen.</p> <p>Press the Red Plus to add the action required. Then select the air conditioner from the list of devices.</p>		
6	<p>Once all the functions required have been added, press the Save button in the top right corner to finalise and save your new Scene</p>		

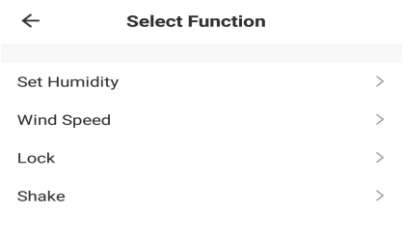
5	<p>Choose the function, set the value for the function, and then press the back button in the top right corner, to return to the previous screen.</p>
	

SETTING UP THE WiFi APP

AUTOMATION

Automation allows an automatic action to be set up for the device. This can be triggered by the Time, indoor temperature, humidity of the room, weather conditions, and a range of other influences.

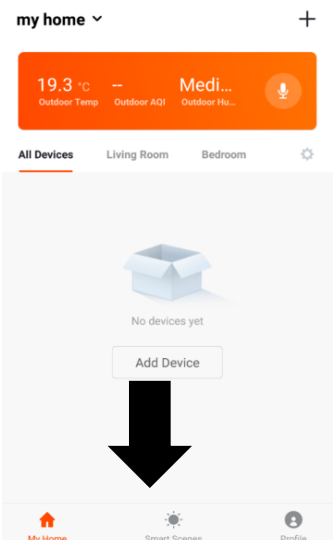
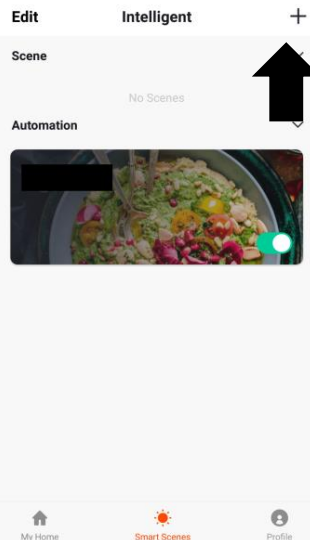
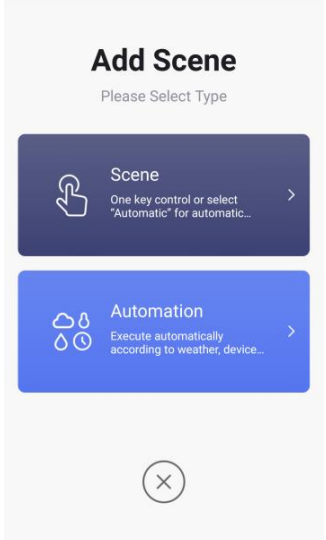
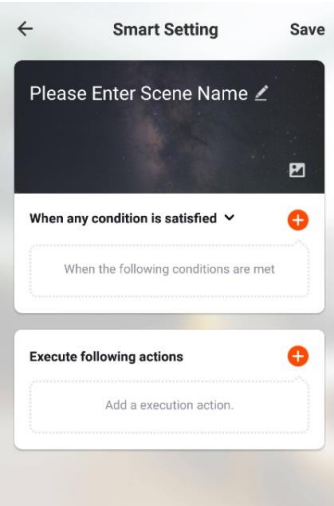
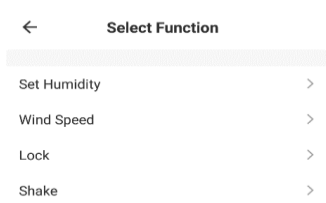
<p>1</p>	<p>Press the Smart Scene tab at the bottom of the Home screen</p>	<p>2</p>	<p>Press the + in the top right corner to add a smart scene.</p>	<p>3</p>	<p>Press Automation to create a new Automation scene</p>
					
<p>4</p>	<p>Setup is very similar to the scene setup on the previous page, and includes an extra section for specifying a trigger for the scene to start.</p> <p>Press the Pen next to Please Enter Scene Name to input the name for your Scene</p> <p>Press the Red + next to When any condition is satisfied to add the trigger</p> <p>Press the Red + next to Execute following actions to add the action required. Then select the air conditioner from the list of devices.</p>		<p>5</p> <p>Select the condition when the automation should start. A number of triggers can be combined.</p> 		
<p>6</p>	<p>Chose the function, set the value for the function, and then press the back button in the top right corner, to return to the previous screen.</p>	<p>7</p> 	<p>Once all the functions required have been added, press the Save button in the top right corner to finalise and save your new scene.</p> <p>The automation is now set up, it can be turned on and off using the toggle on the image shown on step 2.</p>		



SETTING UP THE WiFi APP

PROFILE TAB

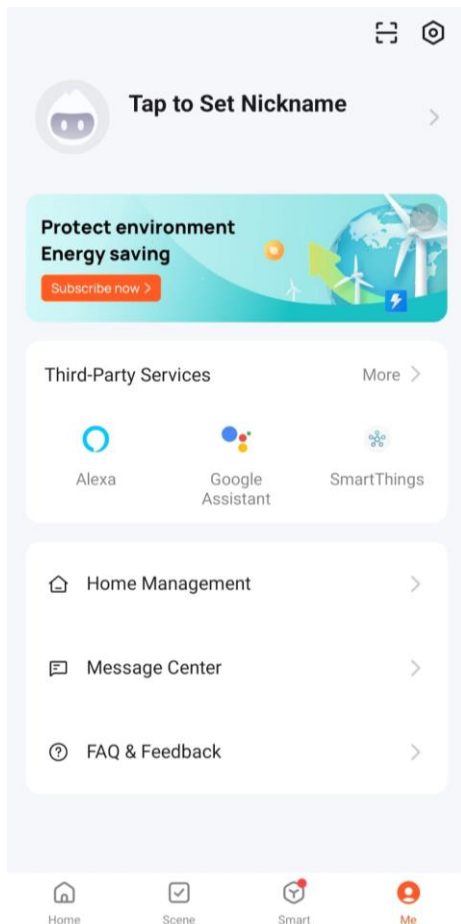

The profile tab gives you the option to edit both your detail, and use the added features of the unit, such as setting up room management, where appliances can be grouped by rooms.

This will also show you the third party support offered on the app, for linking the product up with Google Home and Amazon Alexa.

DEVICE SETTINGS

When in the device screen further settings for the device can be accessed, by pressing on the three dots in the top right hand corner.

CHANGING THE NAME OF YOUR DEVICE

The top option within this allows you to change the name of the device to something relevant to the use of the product, such as “Living Room Air Conditioner”. Within the menu, you also have the option of setting up a pattern lock or change your password.

SHARE DEVICE

This allows you to share access to the controls of your air conditioner with friends and family.

THIRD PARTY CONTROL

This will take you through step by step how to connect the device to your Amazon Alexa or Google Home device.

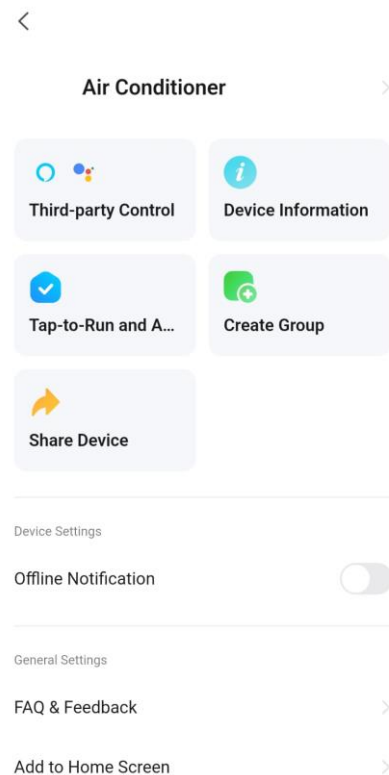

CLEANING AND MAINTENANCE

- Before cleaning, you must turn off the air conditioner and disconnect the power supply for at least 5 minutes.
- Under no circumstances should the air conditioner be flushed with water.
- Volatile liquid (e.g. thinner or gasoline) will damage the air conditioner, so only use soft dry cloth or wet cloth dipped with neutral detergent to clean the air conditioner.
- Clean the filter screen regularly to avoid it clogging with dust, which will affect the airflow to the unit. When the operating environment is dusty, the cleaning frequency should be increased appropriately.
- After removing the filter screen, do not touch the fins of the indoor unit, as these can be sharp.

REMOVING THE GRILL

It is advisable to clean the air conditioner regularly to maintain its appearance and performance.

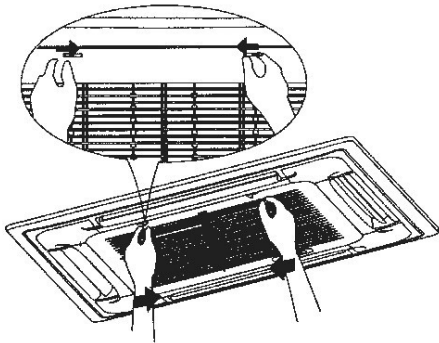

1. Push the two grill switched towards the centre to unhook the grill before pulling the centre of the panel downwards.

2. Care must be taken with the electrical connectors (connecting the panel to the main cassette) If necessary these should be disconnected.
3. Hold the grill at a 45° angle to the unit and lift to unhook from the rear of the panel.
4. The filter can then be removed from the grill for cleaning.

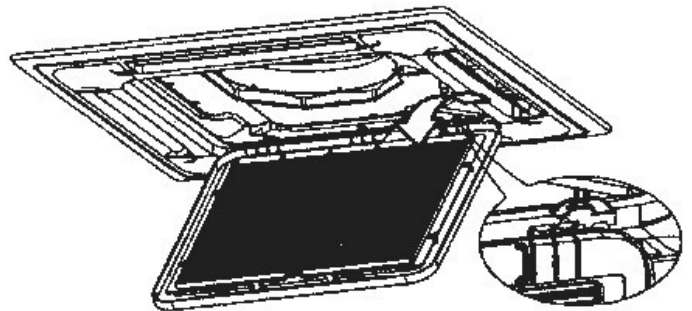

CLEANING OF THE AIR FILTER

Following removal of the air filter following the steps above, it should be cleaned in warm soapy water (<math><40^{\circ}\text{C}</math>).

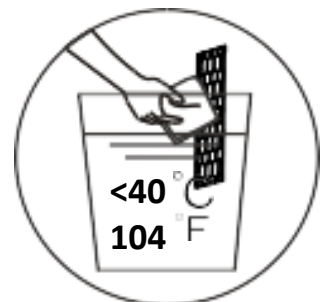

CLEANING AND MAINTENANCE

END OF SEASON MAINTENANCE

If the air conditioner is not going to be used for an extended period:

- Use the Self-Clean mode or set the air conditioner to fan mode on a slightly warm day so that the inside of the appliance dries out.
- Switch off the power at the fuse box and remove the batteries from the remote control.
- Clean the filters.

START OF SEASON PREPARATION



If the air conditioner is to be used again after an extended period:

- Check that the air intake and exhaust openings of the interior and exterior units are not blocked. Remove any dirt or debris that has accumulated.
- Check that the filter is installed within the indoor unit and is clean.
- Check that the condensation outlet drains properly and there is no dirt or organic blockage (otherwise leakage may occur).
- Install 2 AAA batteries in the remote control.
- Turn the appliance on, set the time and desired setting.

REPLACING THE BATTERIES

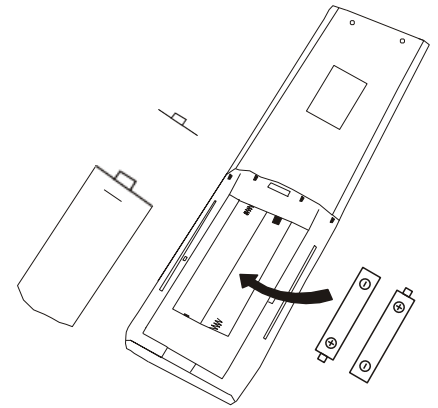
- Remove the cover from the rear of the remote control.
- Replace the AAA batteries, ensuring the correct polarity.
- Reinstall the cover on the rear of the remote control.
- As soon as the batteries are inserted, press and hold the MODE button on the remote until the correct icon is displayed:



	COOLING ONLY
	HEATING AND COOLING

PSTI STATEMENT OF COMPLIANCE

Description: Air Conditioner

Model Number: iQool-SRC18HP, iQool-SRC24HP iQool-SRC36HP iQool-SRC48HP

Manufacturer: electriQ, 2A Trident Business Park, Leeds Road, Huddersfield, HD2 1UA

PSTI Contact: TiSecurity@buyitdirect.co.uk

We have prepared this statement of compliance and can confirm that this product is compliant with the deemed compliance conditions in Schedule 2 of The Product Security and Telecommunications Infrastructure (Security Requirements for Relevant Connectable Products) Regulations 2023.

Duration of security updates: 31/12/2029. This date is correct at the time of printing, but we may extend it. Please visit www.electriQ.co.uk for the latest information and details of our PSTI compliance.

Richard Leach

Compliance and Quality Manager, Buy It Direct, Huddersfield

3rd April 2025

TROUBLESHOOTING AND SELF DIAGNOSIS

MALFUNCTION	POSSIBLE CAUSE
The appliance does not operate	Power failure
	Damaged indoor/outdoor unit fan motor
	Faulty compressor thermomagnetic circuit breaker
	Faulty protective device or fuses
	Loose connections
	Self-protection in adverse conditions
	Voltage higher / lower than the voltage range
	Active TIMER-ON function
	Damaged electronic control board
Strange odour	Air filter dirty
Noise of running water	Back flow of liquid in the refrigerant circulation
A fine mist comes from the air outlet	This occurs when the air in the room becomes very cold, for example in the COOLING or DEHUMIDIFYING modes.
A strange noise can be heard	This noise is made by the expansion or contraction of the front panel due to variations in temperature and does not indicate a problem.
Insufficient airflow, either hot or cold	Inappropriate temperature setting.
	Air inlet or outlet of indoor or outdoor unit has been blocked.
	Air filter is blocked.
	Fan speed set at minimum.
	Other sources of heat in the room.
	No refrigerant.
The appliance does not respond to commands	Remote control is not near enough to indoor unit.
	Battery in Remote controller may have been exhausted.
	Obstacles between remote control and signal receiver in indoor unit.
The display is off	DISPLAY button pressed on remote
	Power failure
Remote cannot select heating mode.	Remove the batteries from the remote and follow the guide for setting up the remote.
Switch off the air conditioner immediately and cut off the power supply in the event of:	
Strange noises during operation.	
Faulty electronic control board	
Faulty fuses or switches.	
Spraying water or objects inside the appliance.	
Overheated cables.	
Very strong smells coming from the appliance.	

TROUBLESHOOTING AND SELF DIAGNOSIS

ERROR SIGNALS ON THE DISPLAY	
In case of error, the display on the indoor unit shown the following error codes:	
Error Code	Failure type
C5	Communication error between indoor unit and wired controller
E0	Indoor and outdoor communication failure
EC	Outdoor communication failure
E1	Indoor room temperature sensor
E2	Indoor coil temperature sensor
E3	Outdoor coil temperature sensor
E4	System abnormality
E5	Model configuration wrong
E6	Indoor fan motor fault
E7	Outdoor temperature sensor
E8	Exhaust temp. sensor
E9	IPM drive and module fault
EA	Current sensor fault
Ed	Indoor EEPROM fault
EC	Outdoor Communication fault
EE	Outdoor EEPROM fault
EF	Outdoor fan motor fault (DC motor)
EH	Outdoor suction temperature sensor fault
En	Outdoor gas pipe temperature sensor fault
EP	Temp. switch fault (on top of the compressor)
EU	Voltage sensor fault
Ey	Outdoor liquid pipe temperature sensor fault
Protection Display Code List	
H1	High pressure switch protection
H2	Low pressure switch protection
H6	Insufficient of refrigerant protection
HE	Phase sequence protection
PA	Indoor run mode conflict
P1	Overvoltage /lower voltage protection
P2	Overcurrent protection
P4	Exhaust over temperature protection
P5	Too cool protection in cooling mode
P6	Overheat protection in cooling mode
P7	Overheat protection in heating mode
P8	Outdoor over temperature / lower temperature protection
P9	Drive protection (software control)
P0	Module protection (hardware control)
PH	Exhaust temperature sensor failure protection of outdoor unit
PC	Coil temperature sensor failure protection of outdoor unit

TROUBLESHOOTING AND SELF DIAGNOSIS

OUTDOOR UNIT FAULT CODES

The outdoor unit has an LED on the power board. This LED will be illuminated when the compressor is running and blink 1s on and 1s off when the compressor is in standby. If there is a fault on the outdoor unit, it will blink on and off for half a second at a time, followed by a 3s gap. The number of consecutive blinks will show the fault as per the table below:

No. of blinks	Fault
1	IPM protection
2	Over voltage /lower voltage
3	Overcurrent
4	Exhaust over temperature protection
5	Outdoor coil over temperature protection
6	Drive fault and protection (V1, VP1)
7	Communication fault with indoor unit
8	Compressor overheat fault (compressor top switch)
9	Short-circuit / open-circuit fault of outdoor temperature sensor
10	Short circuit / open-circuit fault of outdoor heat exchanger temperature sensor
11	Short-circuit / open-circuit fault of exhaust temperature sensor
12	Voltage sensor fault
13	Current sensor fault
14	IPM fault
15	Communication fault between power source board and IPM
16	No feedback from DC fan motor(outdoor unit)
17	Defrost state

WIFI CONTROL TROUBLESHOOTING

Description	Possible Cause
Air conditioner can't be configured successfully	<ol style="list-style-type: none"> 1. Check the mobile device is connected to WIFI 2. Check the AC is connected 3. Check that any firewall or other restrictions are causing problems 4. Check the router is functioning normally 5. Check that the router isn't blocking the App
Mobile device can't control the air conditioner	The app displays "Identification failed". This indicates that the AC has been reset and the mobile device has lost contact with the AC. Reconnect the device following the above instructions. If this fails, delete the AC from your devices list and start the install process from the beginning.
Mobile device can't find AC	The app displays "Air conditioner out of line". Check the below: <ol style="list-style-type: none"> 1. The AC has been reconfigured 2. The AC is not receiving power 3. The router is not powered on 4. The AC can't connect to router 5. The AC can't connect to network through the router 6. The mobile device can't connect to the router 7. The mobile device can't connect to a network (when being used remotely)

TECHNICAL SPECIFICATION

Model		iQool-SRC18HP		iQool-SRC24HP	
Rated voltage and frequency (Ph-V-Hz)		220-240V~/50HZ		220-240V~/50HZ	
Fuse Required		16A		20A	
Mode		Cooling	Heating	Cooling	Heating
Rated capacity (W)		5300 (620~5580)	5800 (760~6100)	7030 (2200~7500)	7900 (2320~8350)
Power input - outdoor (W)		1625 (395~2750)	1620 (350~2400)	2390 (710~3165)	2330 (745~2965)
Current input - Outdoor (A)		7.5 (1.8~12.0)	7.1 (1.6~11)	10.2 (3.8~14)	8.5 (4.0~13)
SEER/SCOP(W/W)		6.3 (A++)	4.0 (A+)	6.2 (A++)	4.0 (A+)
Nominal load (kW)		5.3	4.3	7.03	5.5
Balance point temperature heating (°C)		/	-10	/	-10
Min. outdoor operating temperature (°C)		-15	-15	-15	-15
Thermostat-off mode (W)		5		13.6	
Standby mode (W)		2.5		2.5	
Off mode (W)		2.5		2.5	
Annual consumption (kW)		294	1505	402	2075
Copper Pipe Type length		5m		5m	
Liquid side / Gas side (mm/inch)		6.35 (1/4") + 9.52 (3/8")		6.35 (1/4") + 12.7 (1/2")	
Max. refrigerant pipe length for each unit		30m		30m	
Max. elevation		15m		15m	
Interconnecting Cable		5x1.5mm ²		5x1.5mm ²	
Moisture Removal (L/h)		1.5		2.0	
Indoor	Air Flow (m ³ /h)	1220		1500	
	Dimensions (L*W*H) (mm)	Cassette: 840x840x245 / Panel: 950x950x45			
	Packaging (L*W*H) (mm)	Cassette: 935x935x305 / Panel: 1055x1055x90			
	Net / Gross weight (Kg)	Cassette: 23/27 / Panel: 6/9		Cassette: 24/28 / Panel: 6/9	
	Noise - Sound pressure level (dB/A)	42		46	
	Noise - Sound power level (dB/A)	52		56	
Outdoor	Dimension (L*W*H) (mm)	780x605x307		845x700x342	
	Packaging (L*W*H) (mm)	890x648x385		960x430x755	
	Net / Gross Weight (Kg)	30/33		40/44	
	Noise - Sound pressure level (dB/A)	52		54	
	Noise - Sound power level (dB/A)	62		64	
	Refrigerant type/weight	R32 / 0.95kg		R32 / 1.35Kg	
	CO2 equivalent (T)	0.642		0.911	
	Defrost mode	Automatic defrosting		Automatic defrosting	
Applicable climate types	Cooling:-15-52/Heating:-15-24		Cooling:-15-52/Heating:-15-24		

Due to continuous product development process
specification may change



TECHNICAL SPECIFICATION

Model		iQool-SRC36HP		iQool-SRC48HP	
Rated voltage and frequency (Ph-V-Hz)		220-240V~/ 50Hz		380~415V~/ 50Hz/ 3P	
Fuse Required		25A		20A	
Mode		Cooling	Cooling	Cooling	Heating
Rated capacity (W)		10550 (3080~12300)	10550 (3080~12300)	14070 (3520~15830)	16120 (4100~17290)
Power input - outdoor (W)		3180 (210~4460)	3180 (210~4460)	4400 (920~6430)	4670 (745~6830)
Current input - Outdoor (A)		14.6 (1.0~20.3)	14.6 (1.0~20.3)	5.9 (1.7~9.8)	6.4 (1.4~10.6)
SEER/SCOP(W/W)		6.2 (A++)	6.2 (A++)	6.1 (A++)	4.0 (A+)
Nominal load (kW)		10.5	10.5	14.0	11.2
Balance point temperature heating (°C)		/	/	/	-10
Min. outdoor operating temperature (°C)		-15	-15	-15	-15
Thermostat-off mode (W)		21		21	
Standby mode (W)		15		15	
Off mode (W)		15		15	
Annual consumption (kW)		596	596	830	3900
Copper Pipe Type length		5m		5m	
Liquid side / Gas side (mm/inch)		9.52 (3/8") + 15.9 (5/8")		9.52 (3/8") + 15.9 (5/8")	
Max. refrigerant pipe length for each unit		50m		75m	
Max. elevation		25m		30m	
Interconnecting Cable		3×1.5mm ² and 3×0.75mm ²		4×1.5mm ²	
Moisture Removal (L/h)		3.6		3.6	
Indoor	Air Flow (m ³ /h)	1900		2100	
	Dimensions (L*W*H) (mm)	Cassette: 840×840×290 / Panel: 950×950×45			
	Packaging (L*W*H) (mm)	Cassette: 935×935×305 / Panel: 1055×1055×90		Cassette: 920×920×315 / Panel: 1055×1055×90	
	Net / Gross weight (Kg)	Cassette: 26/31 / Panel: 6/9		Cassette: 28/33 Panel: 6/9	
	Noise - Sound pressure level (dB/A)	53		51	
	Noise - Sound power level (dB/A)	63		61	
Outdoor	Dimension (L*W*H) (mm)	910×378×804		1010×436×858	
	Packaging (L*W*H) (mm)	1022×480×835		1135×530×970	
	Net / Gross Weight (Kg)	55/60		77/89	
	Noise - Sound pressure level (dB/A)	57		60	
	Noise - Sound power level (dB/A)	67		70	
	Refrigerant type/weight	R32 / 2.1Kg		R32 / 1.9Kg	
	CO2 equivalent (T)	1.418		1.283	
	Defrost mode	Automatic defrosting		Automatic defrosting	
Applicable climate types	Cooling:-15-52/Heating:-15-24		Cooling:-15-52/Heating:-15-24		

SUPPORT

electriQ UK SUPPORT

Please, for your own convenience, check the troubleshooting guide before calling the service line.

Support@electriQ.co.uk

0330 390 3061

Office hours: 9AM - 5PM Monday to Friday

www.electriQ.co.uk

Unit 2A, Trident Business Park,

Neptune Way, Leeds Road, Huddersfield, HD2 1UA

EU DECLARATION OF CONFORMITY

Hereby, electriQ declares that these air conditioners are in compliance with Directive 2014/53/EU. The full text of the EU declaration of conformity is available at the following internet addresses:

<https://www.electriq.co.uk/DOC/EU/iQool-SRC18HP.pdf>

<https://www.electriq.co.uk/DOC/EU/iQool-SRC24HP.pdf>

<https://www.electriq.co.uk/DOC/EU/iQool-SRC36HP.pdf>

<https://www.electriq.co.uk/DOC/EU/iQool-SRC48HP.pdf>

UK DECLARATION OF CONFORMITY

Hereby, electriQ declares that these air conditioners are in compliance with Radio Equipment Regulations 2017. The full text of the UK declaration of conformity is available at the following internet addresses:

<https://www.electriq.co.uk/DOC/UK/iQool-SRC18HP.pdf>

<https://www.electriq.co.uk/DOC/UK/iQool-SRC24HP.pdf>

<https://www.electriq.co.uk/DOC/UK/iQool-SRC36HP.pdf>

<https://www.electriq.co.uk/DOC/UK/iQool-SRC48HP.pdf>



Disposal: Do not dispose this product as unsorted municipal waste. Collection of such waste must be handled separately as special treatment is necessary. Recycling facilities are now available for all customers at which you can deposit your old electrical products. Customers will be able to take any old electrical equipment to participating sites run by their local councils. Please remember that this equipment will be further handled during the recycling process, so please be considerate when depositing your equipment. Please contact the local council for details of your local household waste recycling centres.

electriQ

SUPPORT

WARRANTY INFORMATION

electriQ guarantee provides cover against material or manufacturing faults. This means that if your air conditioner develops a fault within the first 2 years, we will arrange for it to be repaired or replaced*. We will also provide replacement parts within the first 5 years.

The system must be installed and annually serviced by an F-gas registered engineer. Evidence of this must be provided when the fault is logged with our technical team. Faults arising from installation errors and/or damage are specifically excluded.

Where we are unable to confirm that a fault is related to a manufacturing fault, we reserve the right to make a charge to cover the costs of an engineer visit to assess and repair the unit. This charge will be refunded in full if the fault is confirmed to be due to a manufacturing fault.

This unit must be operated under conditions as recommended in this user manual, at voltages indicated on the unit. Any attempts made to service or modify the unit by unqualified person, will render this WARRANTY VOID.

This warranty is in addition to, and does not affect, your statutory rights.

* A replacement may be offered where electriQ deem a repair not to be viable.

We recommend that you note the details of your purchase below and retain your original proof of purchase receipt with this manual. Keep these documents safe in the event of a warranty claim.

Purchase Date:	
Retailer name:	
Model number:	
Serial number:	
Installation Date:	
Installer name:	
Engineer/ Company name:	
Engineers Registration Number	
Service Dates	

