

Manufactured by Honsun (Nantong) Co., Ltd.

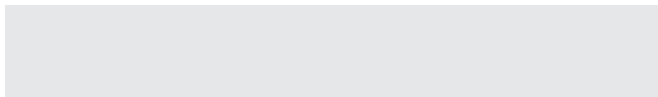

EC REP Shanghai International Holding Corp. GmbH (Europe)
Address : Eiffestrasse 80, 20537 Hamburg Germany

Made in China

Honsun (Nantong) Co., Ltd.
Address : No.8, Tongxing Road, Economic & Technical
Development Area, Nantong City, Jiangsu, P. R. China

kinetik
WELLBEING

CE 0123



Compressor Nebuliser

Instruction Manual

REF NB-222C



CE 0123



IP21



Kinetik NB-222C UK IB 20200513











TABLE OF CONTENT

INSTRUCTION	2
SYMBOLS	2
SAFETY INFORMATION	3
MAIN UNIT	7
PREPARING THE NEBULISER FOR USE	8
USING THE DEVICE	9
CLEANING AND DISINFECTING	9
CARING THE DEVICE	11
STORING THE DEVICE	12
TROUBLESHOOTING	13
WARRANTY OBLIGATIONS	14
CLASSIFICATION	14
PERIODIC SAFETY CHECKS	14
SPECIFICATIONS	15
TECHNICAL DATA FOR NB-222C	16
GUIDANCE AND MANUFACTURER'S DECLARATION	17
COMPLIANCE INFORMATION FOR EACH EMC TEST	17

INSTRUCTION

Thank you for purchasing the NB-222C Compact Compressor Nebuliser. This product was developed for the successful treatment of asthma, allergies and other respiratory disorders. The compressor forces air to the nebuliser. When the air enters the nebuliser, it converts the prescribed medication into an aerosol of microscopic droplets that can easily be inhaled. The Patient is an intended operator Contraindication: None.

SYMBOLS

Symbols	Meaning
	Manufacturer
	Authorized Representative in the European community
	Symbol for the marking of electrical and electronics devices according to Directive 2002/96/EC. The device, accessories and the packaging have to be disposed of waste correctly at the end of the usage. Please follow Local Ordinances or Regulations for disposal.
	CLASS II
	CE marking in conformity with EC directive 93/42/EEC
	Degree of protection against the Ingress of water.
	Read the instructions (actual symbol colours are white on a blue background).
	Type BF Applied Part

SAFETY INFORMATION

To assure the correct use of the product, basic safety measures should always be followed including the warnings and cautions listed in this instruction manual.

WARNING

- For regime of medication shall follow the instructions of your physician or licensed healthcare practitioner.
- Do not cover the compressor with a blanket, towel, or any other type of cover during use. This could result in the compressor overheating or malfunctioning.
- Do not use the device where the device may be exposed to flammable gas or vapors.
- Do not use mineral water in the nebuliser for nebulising purposes.
- Always dispose of any remaining medication in the medication tank after each use. Use fresh medication each time you use the device.
- Do not leave the device or its parts where it will be exposed to extreme temperatures or changes in humidity, such as leaving the device in a vehicle during warm or hot months, or where it will be exposed to direct sunlight.
- To avoid the risk of entanglement and strangulation, store cables and air lines out of the reach of small children.

CAUTION:

- Limit the use of the device to 20 minutes at a time, and wait 40 minutes before using the device again.
- Provide close supervision when this device is used by, on, or near infants, children or compromised individuals.
- Do not insert any object into the compressor.
- Make sure that the air filter is clean. If the air filter has changed color or has been used for 60 days, replace the filter.
- Make sure that the nebuliser kit is correctly assembled, the air filter is properly installed, and the air tube is correctly connected to the compressor and the nebuliser kit. Air may leak from the air tube during use if not securely connected.
- Inspect the compressor (main unit) and the nebuliser parts each time before using the device. Make sure no parts are damaged, the nozzle and air tube are not blocked and the compressor operates normally.

- Do not use the device if the air tube is bent.
- Do not block the air filter cover.
- Do not alter the baffle, the nozzle in the medication tank or any part of the nebuliser kit.
- Do not add more than 10ml of medication to the medication tank.

CAUTION:

- Do not operate the device at temperatures greater than 40°C.
- Do not tilt the nebuliser kit so the angle of the kit is greater than 45°. Medication may flow into the mouth.
- Do not shake the nebuliser kit while using the device.
- Do not subject the compressor, or any of the components to strong shocks, such as dropping on the floor.
- This device is approved for human use only.
- Do not disassemble or attempt to repair the device or components.
- Use the device only for its intended use as described in the instruction manual. Do not use attachments not recommended by the manufacturer.
- Dispose of the device, components and optional accessories according to applicable local regulations. Unlawful disposal may cause environmental pollution.
- Make sure that the air tube is securely attached to the compressor (main unit) and nebulising parts, and does not come loose. Twist the air tube slightly when inserting it into the connectors to avoid the tube disconnecting during use.

RISK OF ELECTRICAL SHOCK

- Do not use the compressor (main unit) and the power cord while they are wet.
- Do not plug or unplug the power cord into the electrical outlet with wet hands.
- Do not immerse the compressor (main unit) in water or other liquid.
- Do not spill water or other liquids on the compressor. These parts are not waterproof. If liquid spills on these parts, please unplug the power cord and wipe off the liquid with gauze or other soft absorbent material immediately.
- Do not use or store the device in humid locations or outdoors. Use the device within the operating temperature and humidity.
- Do not overload power outlets. Plug the device into the appropriate voltage outlet.

- Do not use extension cords. Plug the power cord directly into the electrical outlet.
- Unplug the power cord from the electrical outlet after using the device. Never leave this product unattended when plugged in.
- Unplug the power cord from the electrical outlet before cleaning the device. Completely read all of the instructions included the optional accessories before using them.
- Not to position the ME EQUIPMENT so that it is difficult to operate the disconnection device.
- The power switch is used to isolate the device from the supply mains.
- The direction of movement of the actuator of the supply mains switch is comply with IEC 60447.

MAINTENANCE AND STORAGE

- Keep the device out of the reach of unsupervised infants and children. The device may contain small parts that can be swallowed.
- Do not leave the cleaning solution in the nebuliser parts. Rinse the nebuliser parts with clean hot tap water after disinfecting.
- Wash the nebuliser parts after each use. Dry the parts immediately after washing.
- Do not store the air tube with moisture or medication remaining in the air tube. This could result in infection as a result of bacteria.
- Store the device and the components in a clean, safe location.
- Do not carry or leave the nebuliser with medication in the medication tank.
- Do not place or attempt to dry the device, components or any of the nebuliser parts in a microwave oven.
- Do not wrap the power cord around the compressor (main unit).

SAFETY INFORMATION

The followings are maintenance and repair which can be taken by operator, or which must be operated by manufacturer or distributor

Service and Maintenance	Responsible
Change the inhalation tube	Operator
Change the applied part	Operator
Change the air filter	Operator
Change the surface of the device	Operator
Daily cleaning and disinfecting	Operator
All components (include fuse , power cord) which need to be repaired or changed by disassembling the device	Distributor or manufacturer

WARNING

- Do not modify this equipment without authorization of the manufacturer
- Do not service of maintenance the device while in use with the patient

MAIN UNIT

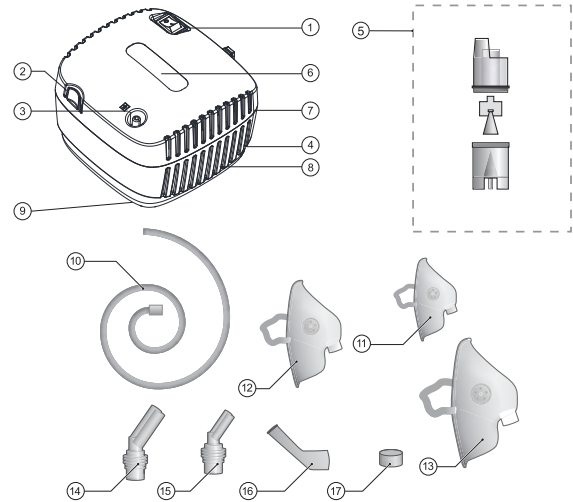

- | | |
|-------------------------|----------------------------------|
| 1. Power switch | 10. Inhalation Tube |
| 2. Holder for Nebuliser | 11. InfantMask(Optional) |
| 3. Air plug | 12. Child Mask(Optional) |
| 4. Dust Screen Cover | 13. Adult Mask(Optional) |
| 5. Nebuliser Kit | 14. Adult Nasal-piece(Optional) |
| 6. Loge | 15. Child Nasal-pieces(Optional) |
| 7. Main Unit | 16. Inhalation Mouthpiece |
| 8. thermal Via | 17. Air Filter |
| 9. Rubber Foot | |

The nebuliser kit,and mask, nasal-piece, mouthpiece are applied parts

PREPARING THE NEBULISER FOR USE

CAUTION:

- Clean and disinfect the nebuliser kit and optional masks before using them for the first time after purchase.
- If the device has not been used for a long period of time, please clean and disinfect the nebuliser kit and optional masks before using them.
- To prevent the risk of cross infection, different persons should never use the same nebuliser kit.
- If the temperature of the device storage is not at 10-40 °C, please let it stand for at least 30 minutes before using.

1. At normal use, place the device on a stable, sturdy and flat surface horizontally, such that the unit can be easily reached when you are seated.

Caution: place the device at least 10cm distance from walls.

2. Make sure that the unit is in the “off” (0) position by pressing on the right side of switch.

3. Insert the power plug into the electrical outlet.

4. Rotate the inhalation top counterclockwise to remove the inhalation top from the medication tank.

5. Add the correct amount of prescribed medication to the medication tank.

6. Turn the inhalation top clockwise until securely closed

7. Attach the desired inhalation accessory.

ATTACHING THE AIR TUBE

1. Push the Air Plug on one end of the Air Tube onto the Air Connector on the front side of the compressor.

2. Push the Air Plug on the other end of the Air Tube onto the Air Tube Connector on the bottom of the Nebuliser Kit

USING THE DEVICE

1. Switch on the power
2. Plug the inhalation tube into the air plug under cover of device.
3. Plug the other side of tube into the vent port of bottom of nebuliser kit.
4. Plug the nebuliser kit into the holder on the device.
5. Add the medicine into the nebulisation tank.
6. Open the O/I button.
7. The device begins to nebuliser.
8. Press the I/O button to safely terminate the operation of nebuliser
9. Unplug the power cord from the electrical outlet after using the device

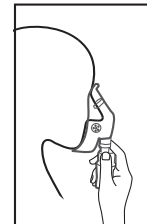

CAUTION

The patient and operator must keep a distance from the device within 20cm to 50cm in normal use

USING THE CHILD MASK or THE ADULT MASK

Place the mask over the nose and mouth. Pull the elastic strap over the head. Gently pull on the strap to securely hold the mask over the nose and mouth. Inhale the medication. Exhale normally through the mask.

NOTE: The mask is outsourcing product, it is purchased from professional manufacturers by CE certification

CLEANING AND DISINFECTING

CLEANING AFTER EACH USE

Following the cleaning instructions after each use will prevent any remaining medication in the bottle from drying resulting in the device not nebulising effectively and will help prevent infections.

WARNING:

Wash the nebuliser parts after each use. Dry the parts immediately after washing.

1. Remove the inhalation accessory (mask, mouthpiece) from the nebuliser kit.
2. Disconnect the air tubing from the nebuliser.
3. Gently twist the inhalation top counterclockwise and lift to separate the nebuliser into two sections.
4. Remove the baffle.
5. Discard remaining medication in the medication tank.
6. Rinse all the parts of the nebuliser kit, the mouthpiece or mask in warm water and a mild detergent. Rinse the mask with hot tap water.
7. Hand dry or air dry in a clean environment using a soft, clean lint-free cloth.
8. Assemble the nebuliser and store the nebuliser kit in a dry, sealed bag.

CAUTION:

The nebuliser kit should be replaced every 6 months.

DAILY DISINFECTING

You can disinfect daily by soaking the parts in a vinegar solution or using a commercially available medical disinfectant. If your physician or respiratory therapist specifies a different cleaning procedure follow their instructions.

Disinfect the nebuliser kit and the mask or mouthpiece after the last treatment of the day.

1. Disconnect the all parts according to the above 1-6 steps.
2. Make a solution of 1 part white vinegar and 3 parts distilled water. Make enough solution to submerge the parts.
3. Submerge the parts in the white vinegar and distilled water solution for 30 minutes.
4. Remove the part and discard the solution. Rinse the parts with hot tap water.
5. Hand dry or air dry in a clean environment using a soft, clean lint-free cloth.
6. Assemble the nebuliser and store the nebuliser kit in a dry, sealed bag.

CARING FOR THE DEVICE

To keep your device in the best condition and protect the unit from damage follow these directions:

CLEANING THE COMPRESSOR

Clean the casing of the main unit by using a soft cloth moistened with water or a mild detergent. Do not use abrasive cleaners. Dry the casing immediately using a soft clean cloth.

CHANGE THE AIR FILTER

Change the air filter every 60 days even if the air filter does not appear dirty. If the air filter appears dirty, or if water or medication has spilled on the air filter, replace with a new air filter immediately.

1. Pull the air filter cover to remove from the front side of the compressor.
2. Remove the dirty filter with hand.

CAUTION:

Do not attempt to wash or clean the air filter. Damp air filters can cause blockages. Do not substitute cotton or any other material for the air filter.

CAUTION:

Wash the air filter cover regularly to prevent any blockage in the cover. Do not boil. Make sure the cover is dry before inserting the new air filter.

3. Insert a new air filter into the air filter cover.

CAUTION:

Before inserting the new air filter makes sure the air filter is clean and free of dust. Do not operate the device without the air filter.

4. Put the air filter cover back on the compressor.
5. Do not maintain or service the device while it is in using.

STORING THE DEVICE

1. Put the nebuliser kit and the inhalation accessory (mouthpiece, or mask) in a dry, sealed bag. Place the bag in the storage pocket of the carrying bag.
2. Coil the air tubing and place in the storage pocket.
3. Place the compressor in the carrying bag.
4. Zipper the bag closed.
5. Store the device in a safe, clean location. Do not store the device in extreme hot or cold temperature, high humidity or in direct sunlight.

WARNING:

Do not leave the device or its parts where it will be exposed to extreme temperatures or changes in humidity, such as leaving the device in a vehicle during warm or hot months, or where it will be exposed to direct sunlight. Keep the device out of the reach of unsupervised infants and children. The device may contain small parts that can be swallowed.

CAUTION:

Do not carry or leave the nebuliser with medication in the medication tank. Do not disassemble or attempt to repair the device or components.

TROUBLESHOOTING

TROUBLESHOOTING GUIDE

PROBLEM	CAUSE	SOLUTION
No power on unit when the power switch is on.	The AC power cord is not plugged into an electrical outlet.	Turn the power switch off. Plug the power plug into an electrical outlet. Turn the device on.
No nebulisation or low nebulisation rate when the power is on.	No medication in the medication tank. Too much or too little medication in the medication tank.	Add the correct amount of prescribed medication to the medication tank.
	The nebuliser kit is not correctly assembled.	Make sure the nebuliser kit is correctly assembled and the inhalation accessory is correctly attached
	The nebuliser kit is tilted at an incorrect angle.	Hold the nebuliser kit correctly. Do not tilt the nebuliser kit so the angle of the kit is greater than 45 degrees.
	The air tube is incorrectly attached.	Make sure the air tube is correctly attached to the compressor and the nebuliser kit.
The device is very hot.	The air tube is folded or damaged. The air tube is blocked.	Make sure the air tube is not folded, kinked or bent. Inspect the air tube for any damage. Replace the air tube if damaged.
	The compressor is covered. The device has been used for longer than 20 minutes.	Do not cover the compressor with any type of cover during use. Turn the device off. Wait 40 minutes before using the device again.

WARRANTY OBLIGATIONS

1. Warranty for this compact compressor nebuliser is 12 months since the date of purchase.
2. The warranty obligations are prescribed by warranty certificate for buyer.
3. The addresses of organizations for guarantee maintenance are present in the warranty certificate.

CLASSIFICATION

Equipment Classification with respect to protection from electric shock: CLASS II
Degree of protection from electric shock: TYPE BF
Degree of protection against ingress of water is rated as IPX0.
Equipment not suitable for use in the presence of flammable anesthetic mixture with air, oxygen or nitrous oxide.
Intermittent operation: 20minutes ON, 40minutes OFF

PERIODIC SAFETY CHECKS

Preventive inspection and maintenance to be performed including the frequency of such maintenance

1. Please clean the plug of power cord at least once a year. Too much dust on plug may cause the fire.
2. The following safety checks should be performed at least every 24 months by a manufacturer's engineer who has adequate training, knowledge, and practical experience to perform these tests.
 - a) Inspect the equipment and accessories for mechanical and functional damage.
 - b) Inspect the safety relevant labels for legibility.
 - c) Inspect the fuse to verify compliance with rated current and breaking characteristics.
 - d) Verify that the device functions properly as described in the instructions for use.
 - e) Test the enclosure leakage current according to IEC 60601-1 Limit: NC 100 uA, SFC: 500uA.
 - f) Test the patient leakage current according IEC 60601-1Limit: for a.c.: 100 uA, for d.c.: 10 uA.
 - g) Test the patient leakage current under single fault condition according IEC 60601-1 Limit: for a.c.: 0.5 mA, for D.C.:50uA.

The leakage current should never exceed the limit. The data should be recorded in an equipment log. If the device is not functioning properly or fails any of the above tests, the device has to be repaired.

SPECIFICATIONS

Model	NB-222C
Rated Voltage	AC 230V, 50Hz
Extreme Pressure	>210KPa
Free Flow Range	>7L/min
Nebulising Pressure	60~180Kpa
Noise Level	≤ 65dB
Rated Power	≤ 200VA
Max capacity of nebuliser kit	10ml
Particle Size	≤5 μm & 60%
Nebulising Rate	≥0.2ml/min
Operation mode	20 minutes on, 40 minutes off
Operation Temperature and humidity atmospheric pressure	10°C ~ 40°C, 85% and below, 860~1060hPa
Transport and storage temperature and humidity/atmospheric pressure	-10°C ~ 40°C, 95% and below, 500~1060hPa
Size	140mm x 140mm x 100mm
Pollution Degrees	Degrees 2
Oversvoltage Category	Category II
High Altitudes (m)	2000m
Accessories	Nebuliser kit, inhalation mouthpiece, inhalation tube

NOTES:

- Subject to technical modification without prior notice.
- Please note that specifications may vary with medication type used.
- Do not use the device where it may be exposed to flammable gas.

- This unit conforms to EMC Standard IEC60601-1. However, if it is used together with other medical devices or electrical equipment, they may influence the operations of one of devices. Please follow any instructions in the manuals and use all devices correctly.

Compressor Nebuliser with respect to electric shock, fire and mechanical hazards only in accordance with IEC60601-1

TECHNICAL DATA FOR NB-222C

Particle Size: MMAD Appr ox. 3.4 μm (MMAD=Mass Median Aerodynamic Diameter)

Medication Tank Capacity: 10ml maximum

Approximate Medication Quantities: 2ml minimum - 10ml maximum

Aerosol Output: 1.98ml (2ml, 2.5%NaF)

Aerosol Output Rate: 0.46ml/min (2ml, 2.5%NaF)

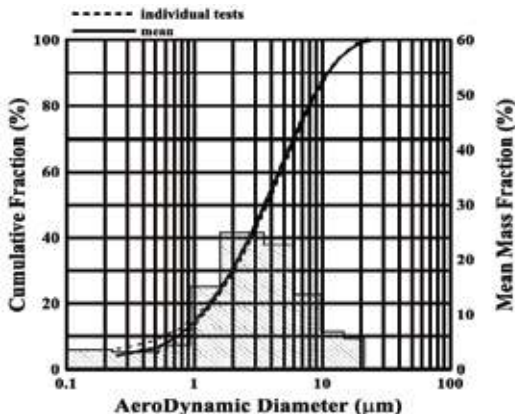

Plot of cumulative size distribution of results

Guidance and manufacture's declaration – electromagnetic emissions-for all EQUIPMENT and SYSTEMS

Warning:

- Use of this equipment adjacent to or stacked with other equipment should be avoided because it could result in improper operation. If such use is necessary, this equipment and the other equipment should be observed to verify that they are operating normally.
- Use of accessories, transducers and cables other than those specified or provided by the manufacturer of this equipment could result in increased electromagnetic emissions or decreased electromagnetic immunity of this equipment and result in improper operation."
- Portable RF communications equipment (including peripherals such as antenna cables and external antennas) should be used no closer than 30cm(12 inches) to any part of the nebuliser, including cables specified by the manufacturer. Otherwise, degradation of the performance of this equipment could result."
- Under the test conditions specified in Immunity, the product can provide the basic safety and essential performance.
- The Emissions characteristics of this equipment make it suitable for use in home healthcare environment (CISPR11 Class B).

Compliance information for each EMC test

Electromagnetic Emission (Home Healthcare Environment)	
Emission test (IEC60601-1-2:2014)	Compliance
Conducted and radiated RF emissions	CISPR 11 Group 1 Class B
Harmonic emissions IEC 61000-3-2	Class A
Voltage fluctuations/flicker emissions IEC 61000-3-3	Complies

Compliance information for each EMC test

Electromagnetic Emission (Home Healthcare Environment)	
Emission test (IEC60601-1-2:2014)	Compliance
Conducted and radiated RF emissions	CISPR 11 Group 1 Class B
Harmonic emissions IEC 61000-3-2	Class A
Voltage fluctuations/flickeremissions IEC 61000-3-3	Complies

Compliance information for each EMC test

Declaration - Electromagnetic Immunity (Home Healthcare Environment)		
Immunity test	IEC 60601 test level	Compliance level
Conducted RF IEC 61000-4-6 :2013	3V 150 kHz to 80 MHz 6 V in ISM and between 0.15 MHz and 80 MHz	3V 150 kHz to 80 MHz 6 V in ISM and between 0.15 MHz and 80 MHz
Radiated RF IEC 61000-4-3 :2006+A1:2007+A2:2010	10 V/m 80 MHz to 2.7GHz	10 V/m

Declaration - Electromagnetic Immunity (Home Healthcare Environment)		
Immunity test	IEC 60601 test level	Compliance level
Electrostatic discharge (ESD) IEC 61000-4-2 :2008	±8kV contact ±2 kV, ±4 kV, ±8 kV, ±15 kV air	±8kV contact ±2 kV, ±4 kV, ±8 kV, ±15 kV air

Compliance information for each EMC test

Declaration - Electromagnetic Immunity (Home Healthcare Environment)		
Immunity test	IEC 60601 test level	Compliance level
Electrical fast transient/burst IEC 61000-4-4 :2012	±2kV for power supply lines	±2kV for power supply lines
Surge IEC 61000-4-5 :2005	± 0.5kV, ± 1 kV line(s) to lines	± 0.5kV, ± 1 kV line(s) to lines
Voltage dips, short interruptions and voltage variations on power supply input lines IEC 61000-4-11 :2004	0% U _T , 0.5 Cycle at 0°,45°,90°, 135°,180°,225°,270° and 315° 0% U _T , 1 Cycle and 70% U _T , 25/30 cycles single phase: at 0° 0% U _T , 250/300 cycles	0% U _T , 0.5 Cycle at 0°,45°,90°, 135°,180°,225°,270° and 315° 0% U _T , 1 Cycle and 70% U _T , 25 cycles single phase: at 0° 0% U _T , 250 cycles
Power frequency (50/60Hz) magnetic field IEC 61000-4-8 :2009	30A/m	30A/m

NOTE: The EUT is the a.c. mains voltage prior to application of the test level. The following phenomenon is still fulfill the requirement of basic safety and essential performance.

* UT:230V~/50Hz, The pressure of the EUT is deviation the normal value but the value is still more than 10psi when flow is 4.5l/min.

**UT:230V~/50Hz, The EUT stop working when adding 0% UT, but the EUT can restore its normal mode automatically.