

# 13'x20' Carport

Product ID. QCS7M

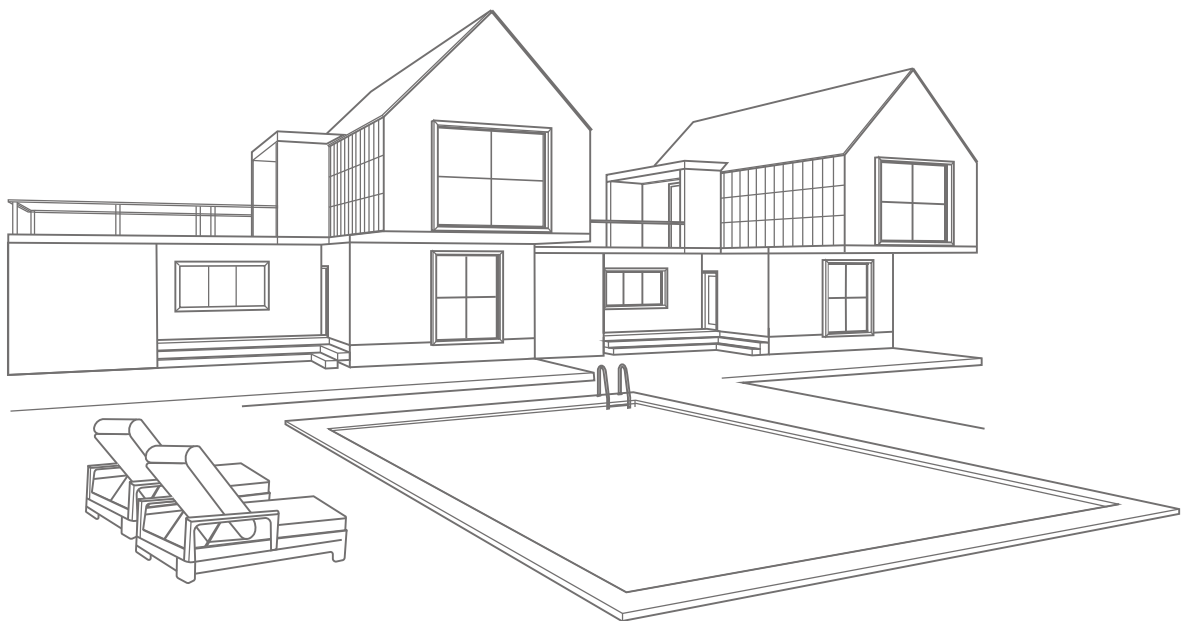

Scan for Support  
[support@garvee.com](mailto:support@garvee.com)



Distributed by  
**GARVEE**.com

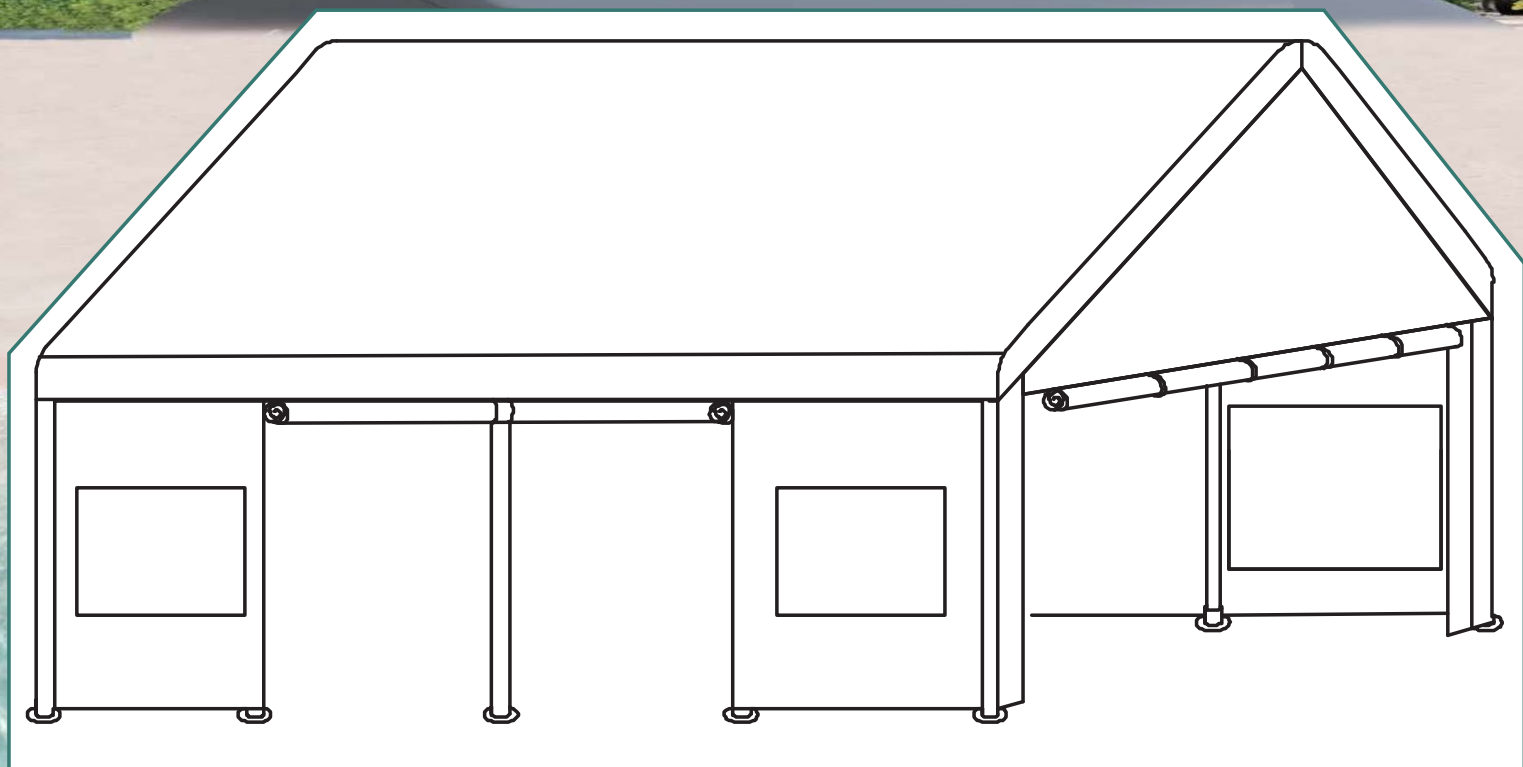

13 X 25 FT

CARPORT USER MANUAL

---

**⚠ Attention:**

**Please read the manual completely before starting the installation**(A ladder & an electric drill are recommended for the assembly.)

**1. Please confirm that the parts are complete and undamaged.**

(Corresponding part number is affixed to each part)

If any parts are missing or damaged, please contact the customer support email to reissue or contact seller.

1.1 customer support email: [dexso\\_service@outlook.com](mailto:dexso_service@outlook.com)





Please Contain: ① Order number ② Model number ③ Item Number ④ Photos of the missing/damaged parts(optional)



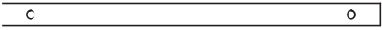
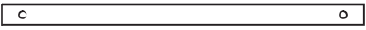
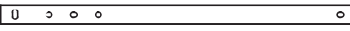

**1.2 Steps to Contact seller (amazon.com orders only):**

Step 1: Log into your Amazon account

Step 2: Go to “Your Orders” and find the purchase

Step 3: Click on “Contact Seller”

Item NO.	Item Name	Reference Image	Qty.
1	Steel Pipe		12 PCS
2	Steel Pipe		10 PCS
3	Steel Pipe		10 PCS
A	3-Way Corner Connector		6 PCS
B	4-Way Corner Connector		9 PCS
D	Foot Plate		10 PCS

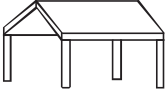
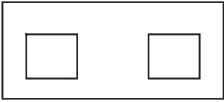
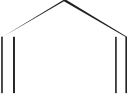
Item Name	Reference Image	Qty.
Ground Peg		30 PCS
M6 x 50MM Screw		10 PCS + 2 PCS Spares
Rope		8 PCS
Anchor		4 PCS
Bungee Cords		116 PCS + 3 PCS Spares
Top Cover		1 PCS
Sidewall		2 PCS
Zipper Door		2 PCS

## 2. Arrange and classify the parts neatly to facilitate installation.

This is the part structure diagram of our product, you can combine this diagram and follow the steps to install

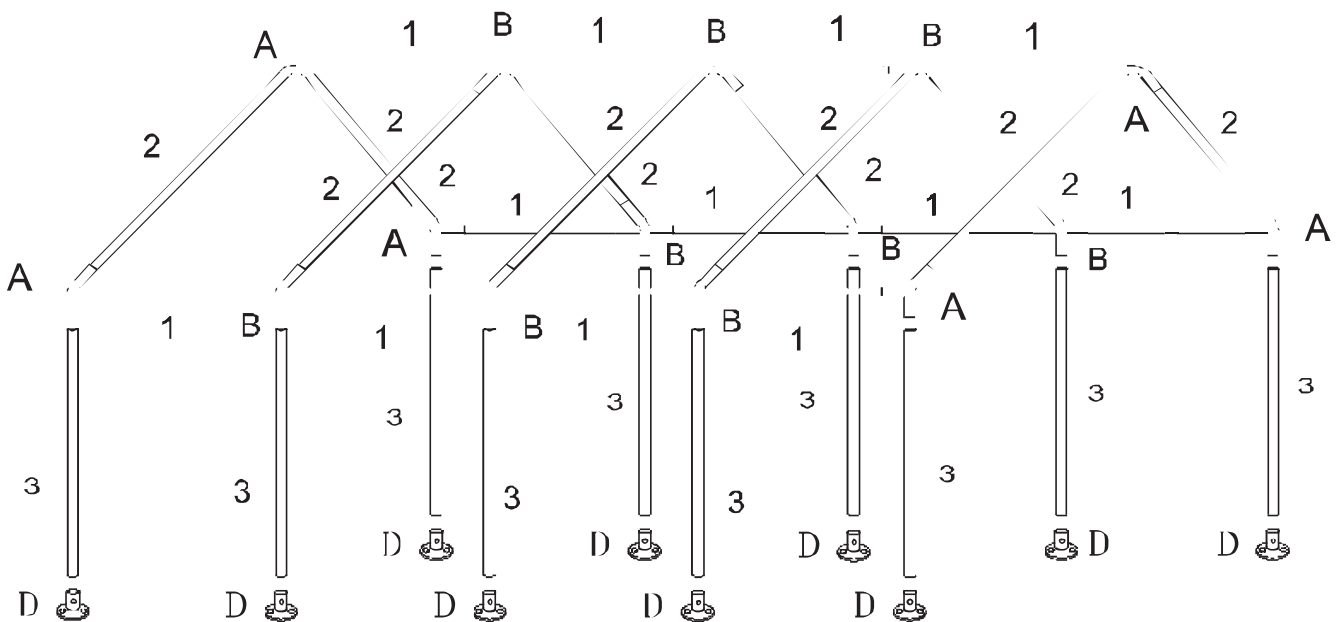

### 3.Start installation works

#### Step 1:

Assemble the long pipes required on the top of the carport (the length after connection is 20 feet), a total of three. You will use ① x 3 pcs, A x 2 pcs, B x 2 pcs for each pipe.

**Part Required**



① 12 PCS



Ⓐ 6 PCS



Ⓑ 2 PCS

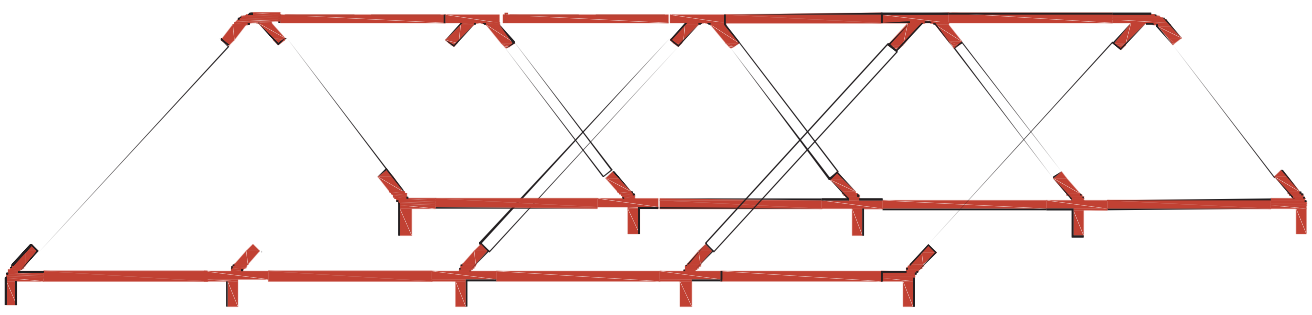
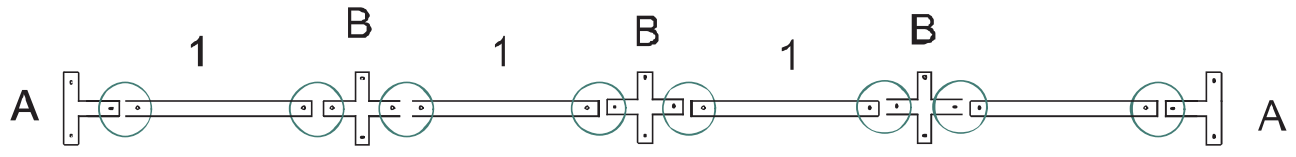

## Step 2:

Connect the obtained three 20 Feet long pipes with the pipe ② to get the carport roof frame.

### Part Required

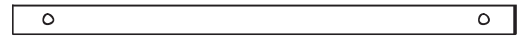

② 10PCS

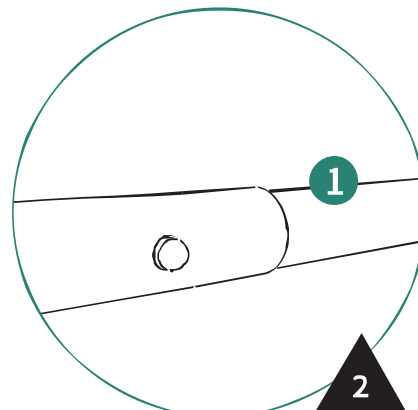
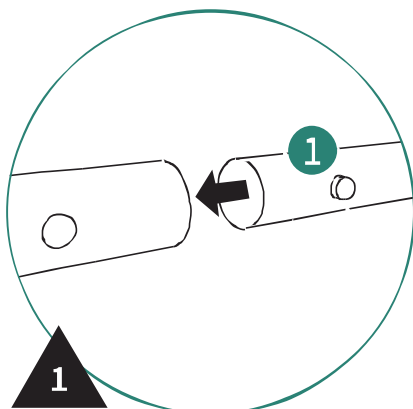
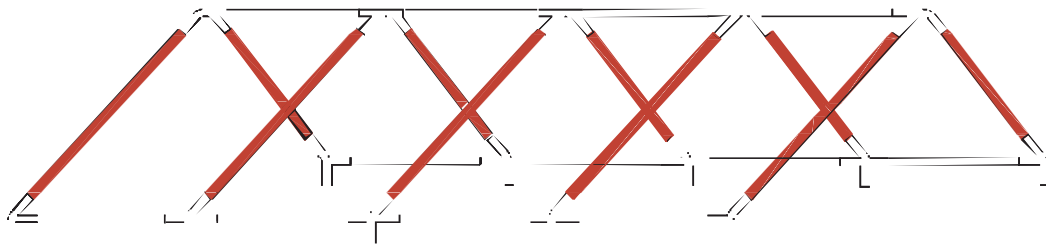

## Step 3:

Put the Top Cover on the top frame and fasten the door side with bungee cords. You will use 6 bungees for each side.

### Part Required



1 PC



12 PCS

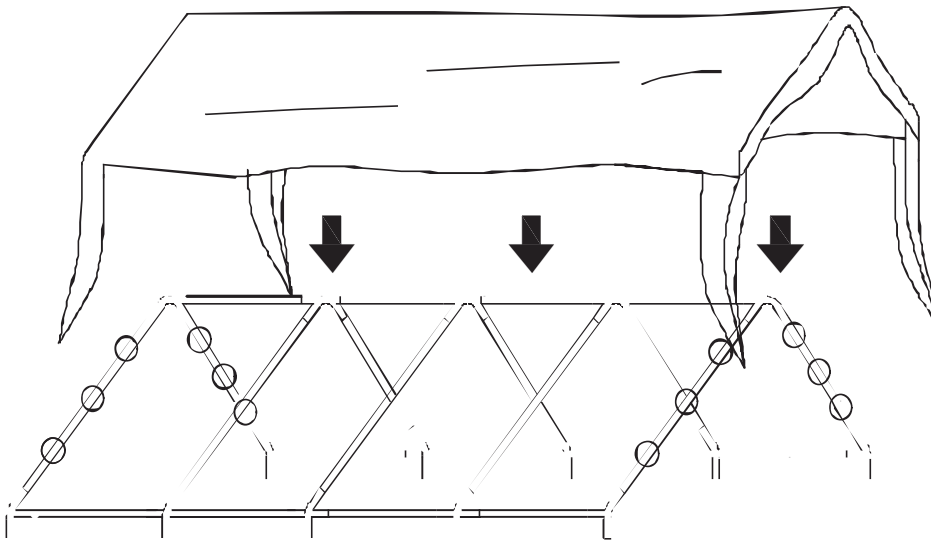

**⚠ Attention:** Be sure to cover the top cover at this time, otherwise the subsequent installation will not work normally

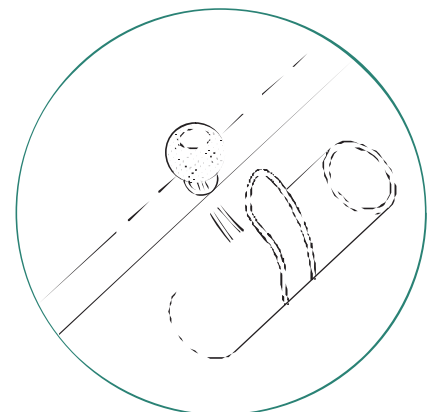

## Step 4:

Connect 2 pipe ③ with the top frame.

### Part Required

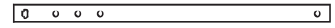

③ 2pcs

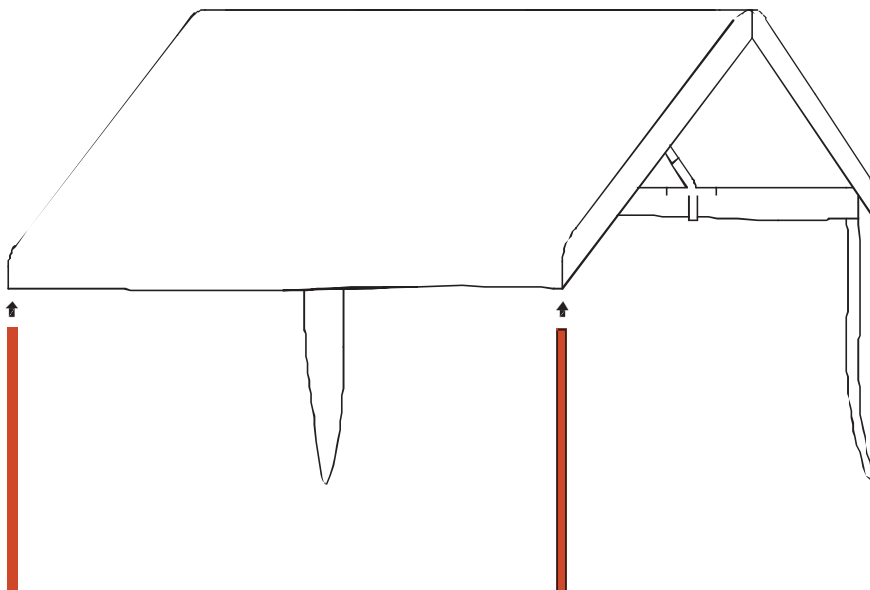
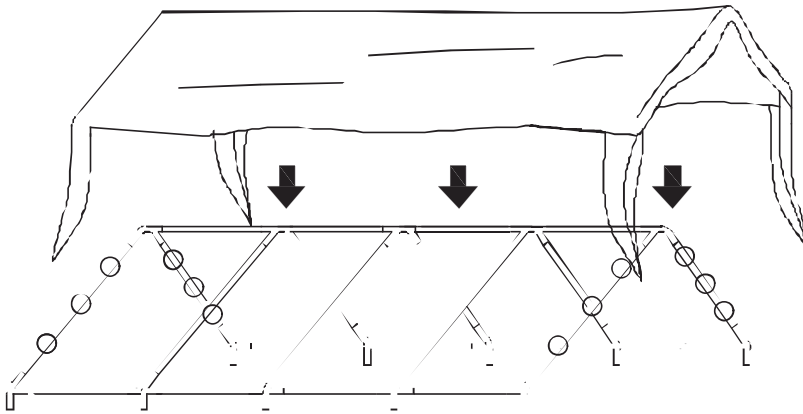

## Step 5:

Connect 3 pipe ③ with the top frame.

**Part Required**

③ 3pcs

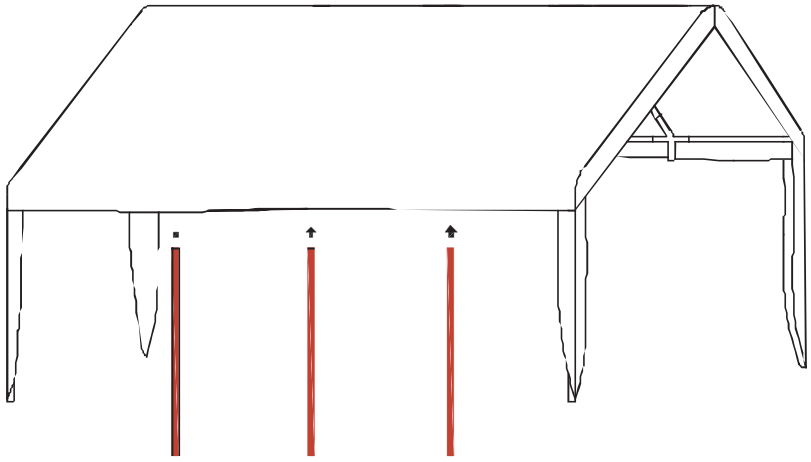

## Step 6:

Repeat the Step 4 & Step 5 to install another side.

**Part Required**

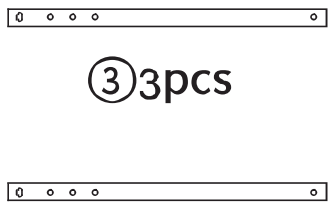

③ 3pcs

③ 2pcs



## Step 7:

Connect the pipe D with ③ pipe that already installed, at this point you will get a complete carport frame with roof.

### Part Required



10 pcs



10 pcs

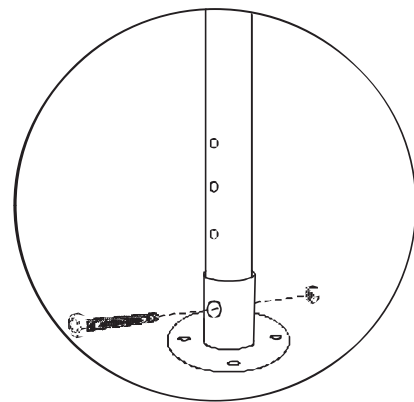
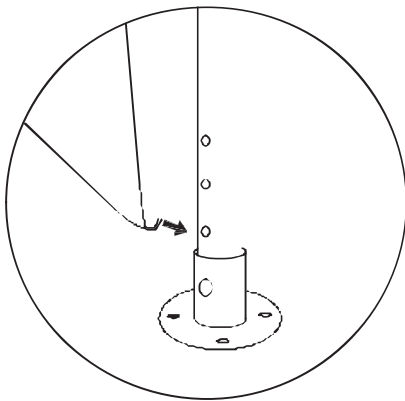
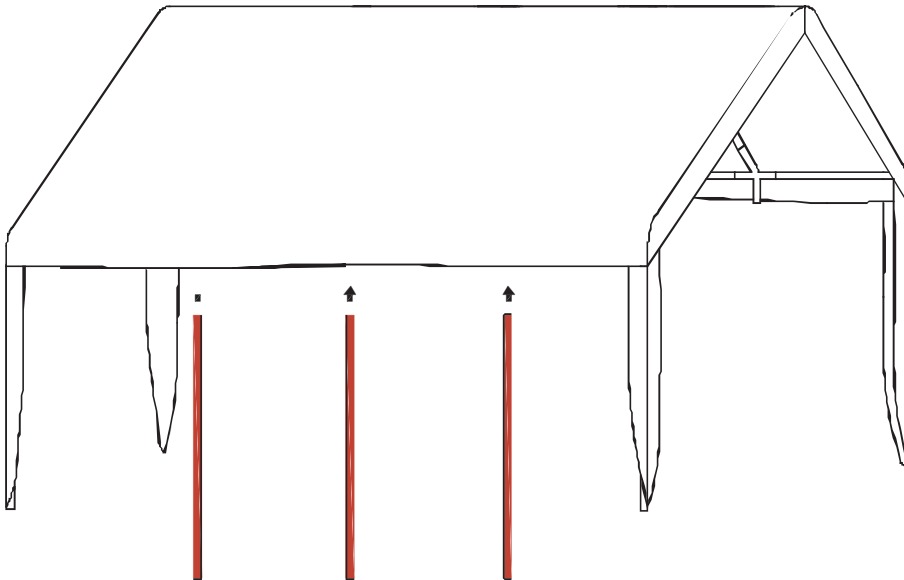

## Step 8:

Use bungee cords to install the gate and side walls.

### Part Required

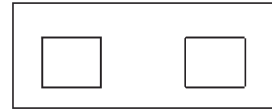

2pcs



68 PCS

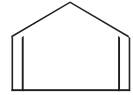

2pcs

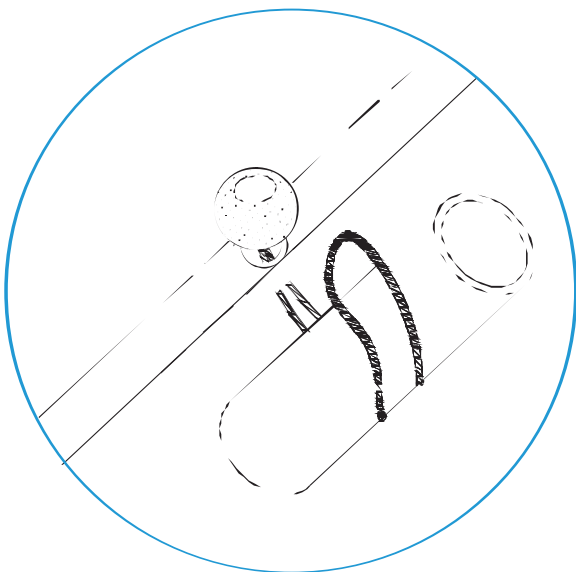
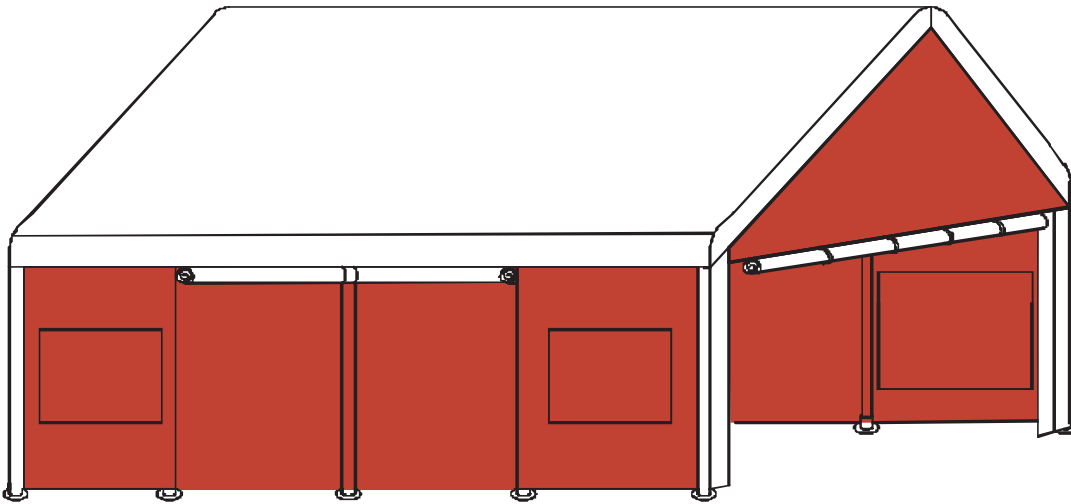

## Step 9:

Fix the drawstring and tent feet to the ground.

### Part Required

$\phi 3$

30pcs



4pcs



8pcs

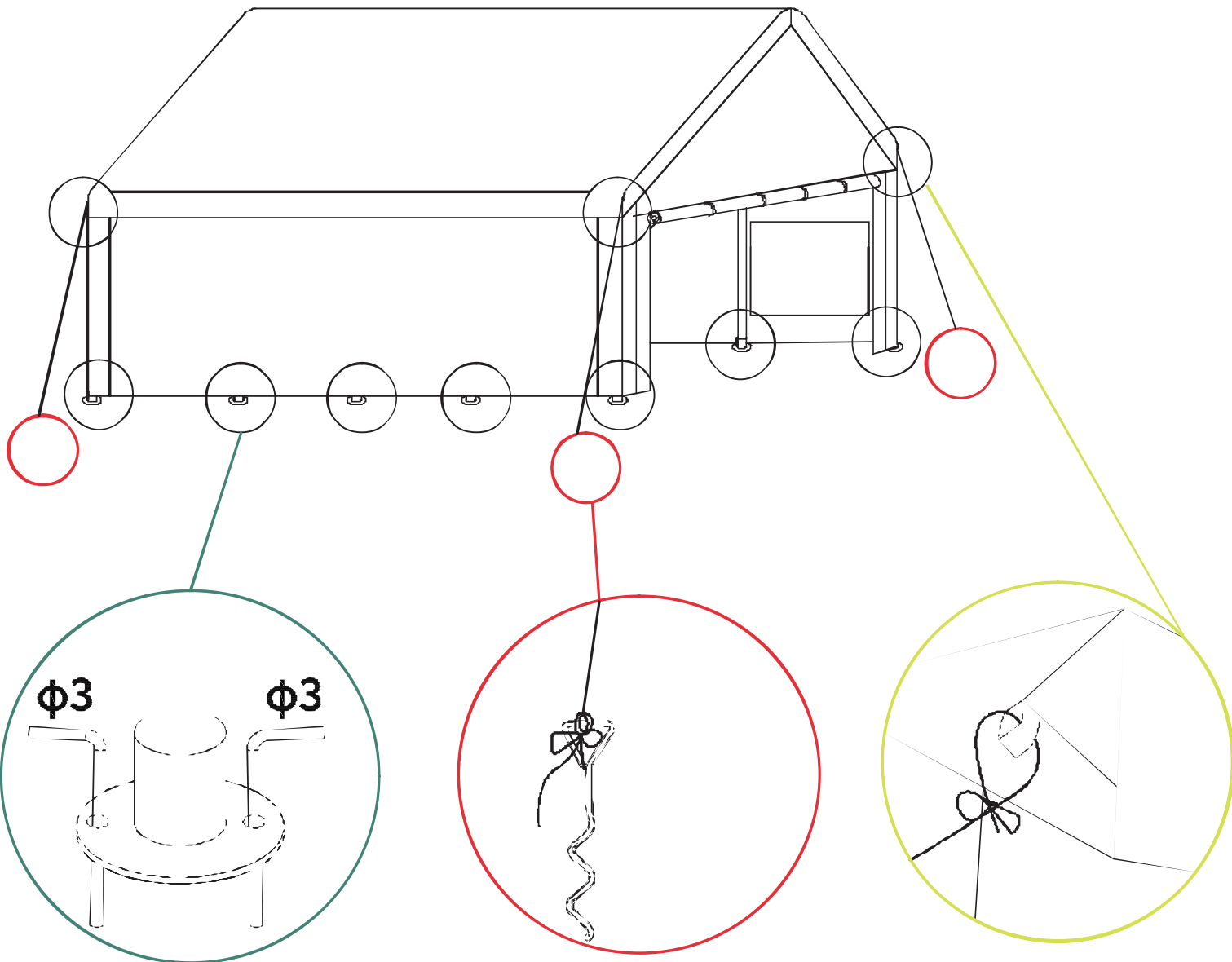

Phone: +1(888) 857-8979 Email: [info@garvee.com](mailto:info@garvee.com)