

PHOENIX GUARDIAN

H. E. P. A. SYSTEM

Therma-Stor Products

Box 8050 Madison, WI 53708

Toll Free 1-800-533-7533

Local 1-608-222-5301

PHOENIX GUARDIAN Operation & Service Instructions

Table of Contents

1. Specifications	1
2. Operation	1
2.1 Transporting the Phoenix Guardian	1
2.2 Location.....	1
2.3 Electrical Requirements	2
2.4 Limiting Amp Draw	2
2.5 Air Ducting.....	2
2.5a Inlet Ducting	2
2.5b Outlet Ducting	3
2.6 Negative Air Ducting	4
2.7 Power/Speed Switch	5
2.8 Hour Meter	5
3. Maintenance	5
3.1 Air Filters	5
3.1a Carbon/Potassium Permanganate Filter.....	5
3.2 Checking Airflow	6
4. Service	6
4.1 Warranty.....	6
4.2 Blower Motor Replacement.....	6
5. Wiring Diagram	7
6. Service Parts List.....	8

Serial No. _____

Purchase Date _____

Dealer's Name _____

Read the operation and maintenance instructions carefully before using this unit. Proper adherence to these instructions is essential to obtain maximum benefit from your Phoenix Guardian dehumidifier.

1 Specifications

Model: Phoenix Guardian

Electrical: 110-120 Vac, 12 Amps, grounded

Airflow: Hi speed: 1400 CFM w/o external ducting

Lo speed: 900 CFM w/o external ducting

Duct Connections:

Inlet: 18" diameter: 18" flex duct can be connected directly to the top; 12" dia. adapter for flex duct

Outlet: 10.5" square: (3) Rectangular wire-form collars for lay-flat plastic ducting; (1) for 14" & (2) for 10"; 12" diameter adapter for flex duct

Size: 25" wide (26.5" over axle)

28" deep w/ handle

39" tall

Weight: 121 lbs.

2 Operation

2.1 Transporting the Phoenix

The Phoenix Guardian should be upright when transported by vehicle. It may be tipped on to its back for loading and moving by hand.

2.2 Location

Note the following precautions when locating the Phoenix Guardian:

- It is designed to be used **INDOORS ONLY**.
- If used in a wet area, plug it into a **GROUND FAULT INTERRUPTER**.
- **DO NOT** use the Phoenix Guardian as a bench or table.
- It must always be used in the upright position.
- The air inlet on top & the front outlet should be at least 1 foot from walls and other obstructions to airflow.

Lit. No. TS-265-0602

2.3 Electrical Requirements

The Phoenix Guardian can be plugged into a grounded 15 Amp circuit. It draws 12 Amps or less with clean filters and no ducting (if less amperage is available, see Section 2.4). Due to the high percentage of a 15 Amp circuit's capacity that the unit uses, the circuit should be dedicated to running the Phoenix Guardian only. Amp draw decreases as filters get dirty and ducting is added.

CAUTION: The unit must always be operated with all three filters and the top in place. Operating it with one or more filters missing, the top off, and/or inferior filters will cause the amperage to increase and the motor to overload.

If an extension cord is required, it must have a minimum of 12 gauge conductors if 25 feet long or less and 10 gauge conductors if greater than 25 feet long.

2.4 Limiting Amp Draw

In certain conditions, allowing the unit to draw its normal 10 to 12 Amps may be undesirable. Limited amperage available may be needed to run other equipment. In such conditions, amp draw can be reduced by restricting the airflow at the inlet with the unit running on either speed. The 18" diameter inlet grid can be restricted by partially covering it with anything convenient and stiff enough to maintain its shape (cardboard, sheet metal, plywood). The negative air pressure at the inlet will help hold the restrictor in place.

2.5 Air Ducting

2.5a Inlet Ducting

Occasionally the area to be filtered is difficult to access and/or the unit cannot be located in the area. In such cases, the air can be ducted to the unit's inlet.

A round 18" diameter flex duct can be attached to the unit inlet on top. It connects by hooking the spiral wire of the flex duct under the four tabs inside the perimeter of the inlet opening; see figures 1, 2 and 3.

Flexible 18" ducting is available from Therma-Stor Products.



Figure 1

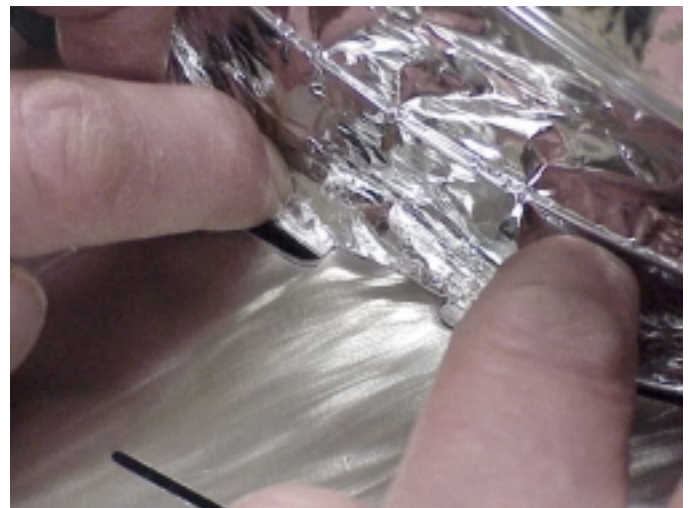

Figure 2

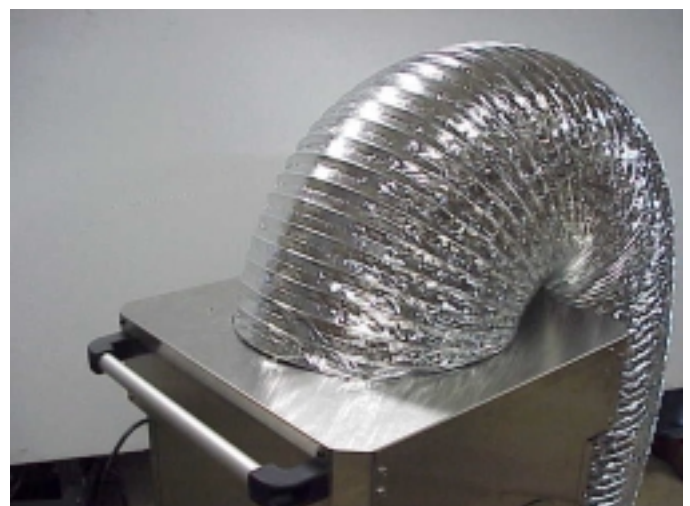

Figure 3

An adapter is included that allows 12" flexible ducting to be connected to the inlet. It is stored on the unit's side. Flex duct is pushed through the adapter center with the adapter hooking tabs facing away from duct; (see figure 4).

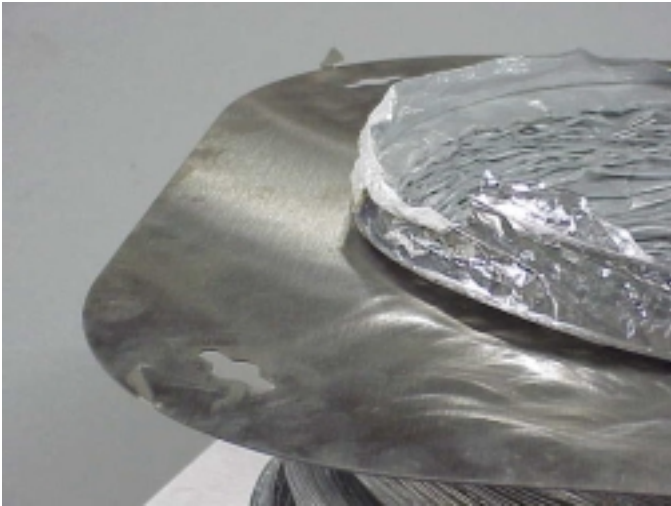

Figure 4

The spiral wire passes from one side of the adapter to the other via the notch on the hole edge; (see figure 5).



Figure 5

The adapter and duct are positioned on the unit top with the four tabs placed into the slots. The adapter is then twisted counterclockwise to lock it in place; see figures 6 and 7.



Figure 6



Figure 7

2.5b Outlet Ducting

Three rectangular wire-form collars are supplied that will allow round lay-flat plastic ducts to be attached to the Phoenix Guardian outlet. The two small collars are made for 10" lay-flat duct; the large one is for 14". Lay-flat plastic ducting is available from Therma-Stor.

To attach ducting to a collar, remove the collar from the unit by loosening the two wing knobs above the collars and sliding the collar out. Put the plastic duct end through the collar center from the front. Fold the duct end outward so that it overlaps the outside of the collar by several inches.

The same adapter that allows 12" flexible ducting to be connected to the inlet can be used to connect 12" flexible duct to the outlet. It is stored on the unit's side. Flex duct is pushed through the adapter center with the adapter hooking tabs facing toward the duct, (see figure 8 and 5).



Figure 8

The four thumb screws that hold the two outlet collar guides must be removed; set the guides aside and reinstall the thumb screws, (see figures 9 and 10).



Figure 9



Figure 10

The adapter and duct are positioned on the unit front so the four slots in the adapter fit over the thumb screws.

Rotate the adapter so the thumb screws are at the end of the slots and tighten the screws; see figure 11.

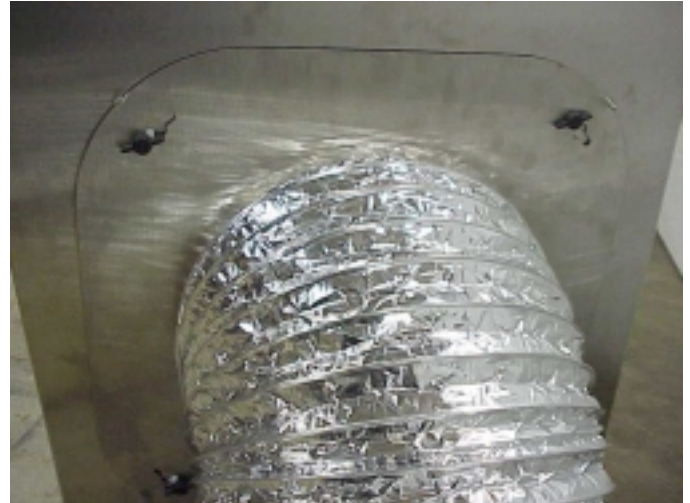

Figure 11

2.6 Negative Air Ducting

The Phoenix Guardian can be used to filter and exhaust air from a space. By exhausting to outside the space, the space will be under a slight negative pressure. This will help prevent airborne particles from leaving the space, since the negative pressure will draw air in through openings in the space's exterior.

The quantity of air exhausted depends on how the unit is ducted and which speed is used. One or two ducts can be directed outside. If all the filtered air is ducted outside, this would result in up to 1300 CFM being exhausted on high speed and an equal amount of fresh air being drawn in.

CAUTION: Exhausting too much air from a space with open combustion devices (e.g. furnace, fireplace or water heater) can cause those devices to backdraft. This can contaminate the space with potentially fatal gases. In such cases, the Phoenix Guardian must be used in one of the following three ways: (A) as a filtering unit only. Exhausting no air from the space and thus causing no negative pressure or backdrafting. (B) Exhausting a very limited amount of air which does not cause backdrafting. In case B, the open combustion devices must be thoroughly checked to guarantee that they do not backdraft while the Phoenix Guardian is running. (C) direct one or more outlet ducts from the Guardian to the room with the open combustion device(s). This will positively pressurize the room, thus preventing backdrafting. As in case B, those combustion devices must be checked after the Guardian is running to guarantee that they are not backdrafting.

One duct can be directed outside, exhausting a portion of the filtered air. The rest of the filtered air can be recirculated inside the space with or without outlet

ducting. Varying the collars' position in the guides at the outlet can control the quantity of air exhausted. To determine precisely the amount exhausted, an airflow meter is required.

2.7 Power/Speed Switch

The power/speed switch is located on the unit side. When turned on to high or low speed, it powers the blower and hour meter.

OCCASSIONALLY THE BLOWER MAY NOT START ON LOW SPEED. IF THIS OCCURS, START THE UNIT ON HIGH SPEED, THEN SWITCH IT TO LOW SPEED.

CAUTION: Do not remove the top to access the filters with the unit on. Removing the top and filters while running can: (A) damage the blower motor by causing it to overload, (B) expose potentially fatal high voltage electrical parts, (C) expose the dangerous rotating blower impeller.

2.8 Hour Meter

A digital hour meter is located near the power switch on the unit side. It measures the cumulative time that the unit is turned on to tenths of an hour. It stores its total when the unit is unplugged. The previous total will be displayed when the unit is on or off. It resets to zero after 99,999.9 hours of operation.

3 Maintenance

3.1 Air Filters

The standard Phoenix Guardian is equipped with three filters that progressively filter out smaller particles. An optional activated carbon/potassium permanganate filter can be used, giving a fourth stage of filter media (see section 3.1a). These filters must be checked regularly. Operating the unit with dirty filters will reduce the airflow and current draw, but will do no harm to the unit. The unit can be run indefinitely with dirty filters.

CAUTION: The unit must always be operated with all three filters and the top in place. Operating it with one or more filters missing, the top off, and/or inferior filters will cause amperage to increase and may cause the motor to overload. Permanent damage could result.

The three standard filters used are listed below (as installed in the unit from top to bottom):

- A. Polyester media pad pre-filter. Actual size is 23-3/8" x 23-3/8" x 1" thick. The white side faces up. This filter should be replaced when the airflow is reduced,

it is visibly dirty or when it is contaminated by a previous job.

- B. 25 to 30% efficient (per ASHRAE 52.1-1992) pleated fabric filter. Actual size is 23-3/8" x 23-3/8" x 1-3/4". This filter should be changed when airflow is reduced or it is contaminated by a previous job.
- C. 99.97% DOP efficient HEPA filter. Actual size is 23-3/8" x 23-3/8" x 12-1/2". It contains at least 175 sq. ft. of media. This filter should be changed when airflow is reduced or it is contaminated by a previous job.

3.1A Activated Carbon/ Potassium Permanganate Filters

Two optional gas phase filters are available from Therma-Stor: a disposable and a refillable. Each uses a blend of activated carbon and potassium permanganate. This blend removes the vast majority of contaminants encountered in most filtering applications. The activated carbon removes the heavier volatile organics while the potassium permanganate removes lower molecular weight contaminants. This is well suited to the smoke odors present after fire damage.

The life of the media blend depends upon both the hours used and the contamination level. Another advantage of the blended media versus activated carbon only is that part of the blend changes color as it loads up with contaminants. It starts out black, then turns pink, then brown, and finally white. It is best changed when it passes the brown stage and begins to turn white. It has lost most of its effectiveness at that point. When these filters are installed, the pad filter does not need to be installed above them. This allows the operator to check the media color through the top grill of the unit without removing the top.

These filters are the same size as the pleated fabric filter. They are installed above that pleated fabric filter. The pleated fabric filter catches carbon dust that comes off these filters before it reaches the HEPA filter.

The refillable carbon filter is metal-framed and can be refilled with carbon blend media purchased in 5-gallon buckets. The amount of carbon blend media loaded into the filter can be adjusted to the particular amount gas/odor removal required.

The disposable filter contains 7½ pounds of active media.

3.2 Checking Airflow

An inclined tube manometer is attached to the unit to determine if the filters need replacing. It measures negative static pressure between the blower inlet and the HEPA filter outlet.

To check airflow:

- Remove any inlet or outlet ducting, but leave the top and all filters in place. Make sure the unit is sitting level.
- Turn the unit on high speed for at least 15 minutes. Read the number values for the fluid levels in the upper and lower tubes. The fluid levels are slanted. Read the level at the center of both tubes.
- Subtract the lower tube number from the upper tube number. Match this difference to the chart on the manometer label to establish the percentage of clean air flow.

Calculation					
43	51	57	60	62	64
100%	90%	80%	70%	60%	50%
Percentage					

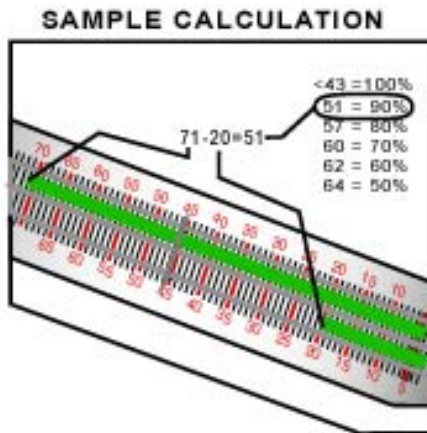

Airflow on high speed with all filters clean and no ducting is about 1400 CFM. The unit can be run with very dirty filters and virtually no flow without harming the unit. The operator's decision to change filters should be based on filter cost versus the unit's filtering effectiveness. If airflow is 700 CFM versus 1400 CFM, the unit will filter particles from a space at half the rate. The operator must judge if that is acceptable.

If the operator determines the filters should be changed due to low airflow, it is most economical to change them in the following order:

- Change the pad pre-filter (top) first. This is the least expensive filter. Recheck the airflow. If the airflow is acceptable, no other filters need to be changed.
- Change the pleated fabric filter (middle) second. It is the second least expensive filter. Recheck the airflow. If acceptable, the HEPA filter does not need changing.

- If the airflow is still too low, the HEPA filter must be changed.

4 Service

CAUTION: Servicing the Phoenix Guardian with its high voltage circuitry presents a health hazard that could result in death, serious bodily injury, and/or property damage. Only qualified service people should service this unit.

4.1 Warranty

A warranty certificate has been enclosed with this unit. Read it before any repair is initiated. If a warranty repair is required, call the factory first at 1-800-533-7533 for warranty claim authorization and technical assistance.

4.2 Blower Motor Replacement

OCCASSIONALLY THE BLOWER MAY NOT START ON LOW SPEED. IF THIS OCCURS, START THE UNIT ON HIGH SPEED, THEN SWITCH IT TO LOW SPEED.

The centrifugal blower has a PSC motor and internal thermal overload protection. Follow the steps below to change the motor:

1. Unplug the power cord.
2. Remove the top and all air filters.
3. Remove the wire nut that connects the blower's white lead to the wire harness. Disconnect the motor's green ground wire from the unit. Remove the black and red wires from the switch.
4. Remove the four nuts that fasten the blower mounting flanges to the base of the unit.
5. Lift the blower out of the unit.
6. Loosen the set screw that holds the impeller hub to the motor shaft.
7. Lay the blower on its side, motor up.
8. Remove the 3 screws that fasten the motor support brackets to the blower housing.
9. Lift out the motor with support brackets.
10. Remove the two screws (one at each motor end) that hold the support brackets to the motor end mounting rings.
11. Remove the six screws that hold the support bracket halves together. Note which holes and slots they were located in.
12. Reassembling with the new motor is the above procedure reversed.

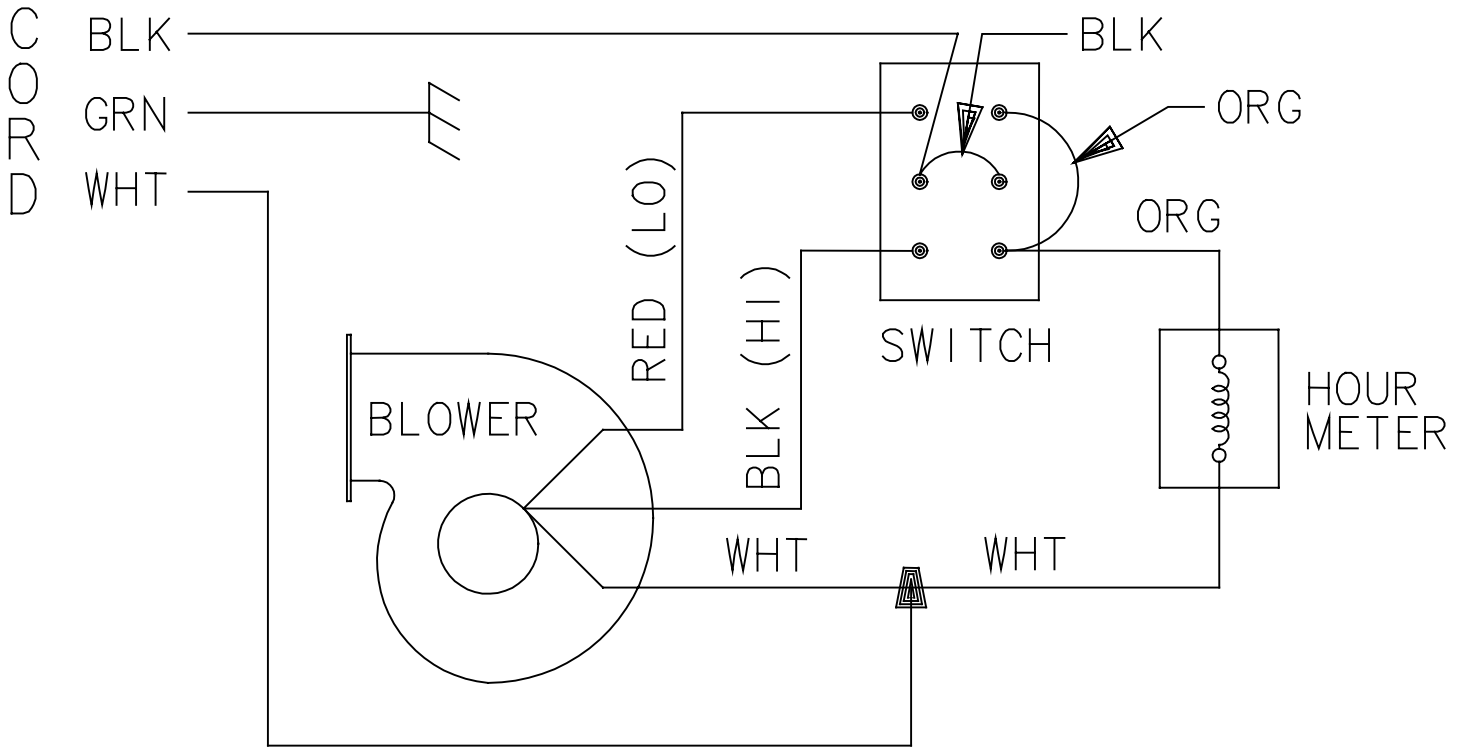

Figure 13: Electrical Schematic



SERVICE PARTS LIST: Phoenix Guardian

Item	Part No.	Qty.	Description	Item	Part No.	Qty.	Description
1	4023374	1	Air Filter, Polyester, 1" x 24" x 24"	15	4024873	1	Manometer Tubing
2	4023375	1	Air Filter, Pleated, 2" x 24" x 24"	16	4023114	1	Motor, 115V, .75Hp, 1625/1180RPM (Fasco P/N 7124-2020)
3	4024741	1	Air Filter, Hepa, 24" x 24" x 12" (99.97% DOP)	17	4023362	*	Nut, Plastic, ¼-20 (Not Shown)
4	4024845	1	Axle	18	4024083	3	Snap Button
*	4024816	2	Axle Cap	19	4024809	1	Suspension Foam Pad (Not Shown)
*	4024817	2	Axle Cap Washer	20	4024871	1	Switch, DPDT, On-Off-On
*	1242497	2	Axle Washer	21	4024827	6	Thumb Screw, ¼-20 X ½" Long
5	4023121	1	Blower (Lau DD10-8A)	22	4024868	4	Thumb Screw, ¼-20 X 1½" Long
6	4024813	1	Cord	23	4024085	1	Top
*	4024811	1	Wire Harness	24	4021591	2	Wheel, 10"
7	4024073	2	Foot				<u>Optional Parts</u>
8	4024076	1	Duct Adapter, 12" Flex Duct, Inlet/Outlet	4023487			Air Filter, Disposable Carbon Blend 2" X 24" X 24"
9	4024808	2	Duct Guide, Outlet Duct Collar	4024764			Air Filter, Refillable Carbon Blend 2" X 24" X 24"
10	4024078	2	Duct Outlet Collar 12" X 5.75" For 10" Lay-Flat Duct (Not Shown)	4024528			Carbon Blend, 5 Gal Pail
11	4024079	1	Duct Outlet Collar 12" X 10.5" For 14" Lay-Flat Duct (Not Shown)	4024750			Duct, Flex, 12" X 25'
12	4024810	1	Handle	4023643			Duct, Flex, 18" X 25'
*	4024069	2	Handle Bracket	4022537			Duct, Lay Flat, 10" X 500'
13	4021597	1	Hour Meter	4024889			Duct, Lay Flat, 14" X 500'
14	4024867	1	Manometer Label				

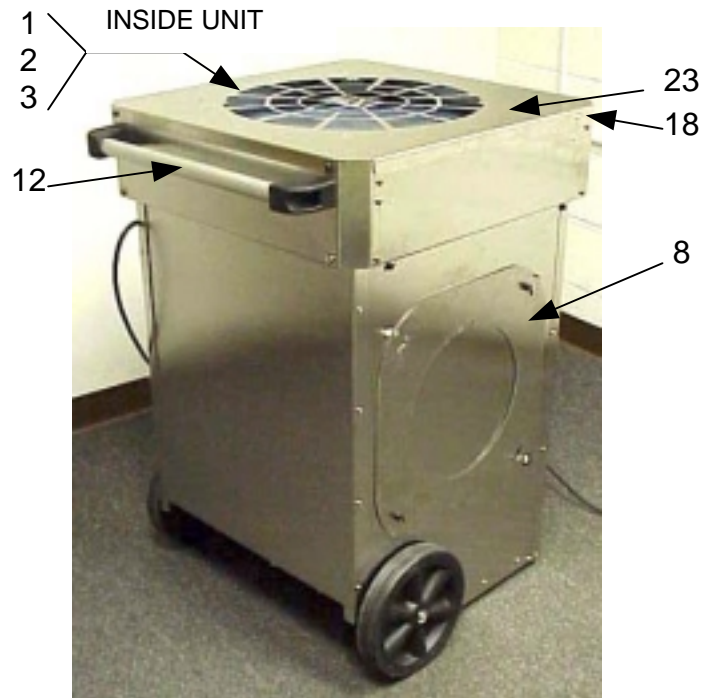
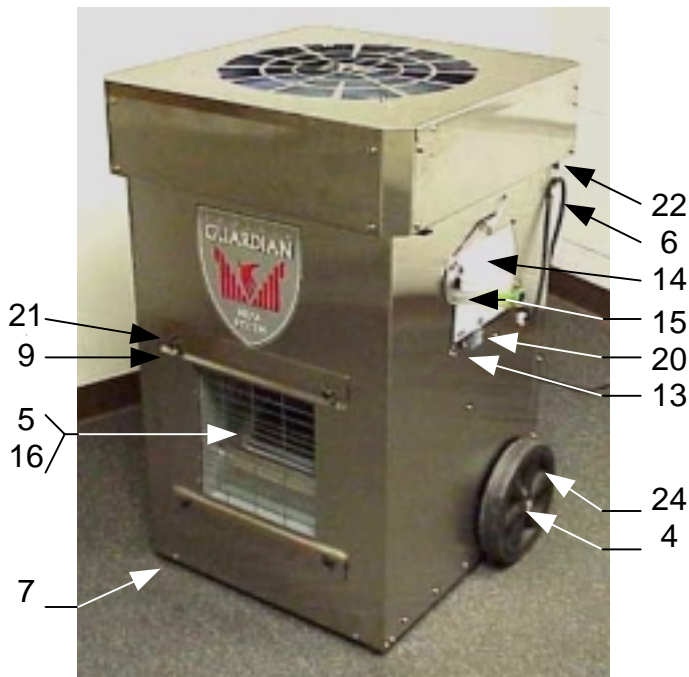

Figure 14.