

Ranein 



Glass Panel Tankless Gas Water Heater

Instruction For Installation And Use

Model: RH8KG-NG / RH8KG-LPG

RH11KG-NG / RH11KG-LPG



 ranein.net

 service@ranein.net

 business@ranein.net



⚠ DANGER

CARBON MONOXIDE HAZARD

This appliance can produce carbon monoxide, which is colorless and odorless. Using it in an enclosed space can be fatal. Never use this appliance in confined areas such as a camper, tent, car, or home.

⚠ DANGER

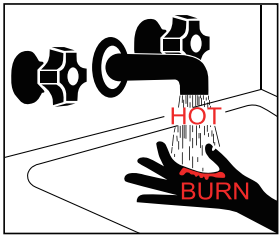

Water temperatures over 125°F (52°C) can cause severe burns or death from scalding instantly. Children, the disabled, and the elderly are at the highest risk of being scalded. Consult the instruction manual before setting the temperature on your water heater. Always feel the water before bathing or showering.

⚠ DANGER

If you smell gas:

1. Shut off the gas to the appliance.
2. Extinguish any open flames.
3. If the odor continues, keep away from the appliance and immediately call your fire department. Failure to follow these instructions could result in a fire or explosion, which could cause property damage, personal injury, or death.

⚠ DANGER

Do not store or use gasoline or other flammable vapors and liquids in the vicinity of this or any other appliance.

Keep this appliance away from all combustible materials. Minimum clearances: rear at 20 inches, two sides at 40 inches, top at 40 inches. Turn off the gas at the cylinder valve after use. Disconnect and remove the cylinder before storing this appliance indoors.

*Please retain the instruction manual for future reference.

www.ranein.net

service@ranein.net

You're All Set!

Thanks for purchasing your new Ranein RH8KG/RH11KG residential tankless water heater. This convenient, safe, and high-efficiency product will open the doors to enjoying endless hot water.

We highly suggest you take the time to read through all of the safety and installation procedures in this manual before attempting to install your new residential water heater. Always remember, we're here for you via our online helpdesk located at www.ranein.net

Read This Manual

Inside, you will find many helpful hints on how to use and maintain your water heater properly. A little preventive care on your part can save you time and money over the life of your water heater. You'll find answers to common problems in the Troubleshooting Guide. If you review the chart of Troubleshooting Tips first, you may not need to call for service.

Read the Safety Information

To ensure your safety and the safety of others, we have included important safety warnings throughout this manual. All safety messages will follow the safety symbol and the words: **"CAUTION", "DANGER", "WARNING", or "NOTICE"**.

These words mean:

⚠ CAUTION

A potentially hazardous situation that may result in minor or moderate injury.

⚠ DANGER

An imminently hazardous situation that will result in death or serious injury.

⚠ WARNING

A potentially hazardous situation that could result in death or serious injury and/or damage to property.

⚠ NOTICE

Attention is called to observe a specified procedure or maintain a specific condition.

CATALOGS

| | |
|---|-------|
| Warning & You're All Set..... | 1-2 |
| Important Safety Information..... | 4-8 |
| Read Before Operating..... | 9-11 |
| Installing the Water Heater..... | 11-19 |
| Gas Supply..... | 19-20 |
| Water Heater Installation Checklist..... | 20-21 |
| Prepare for Installation..... | 22 |
| Installing the Water Heater..... | 23 |
| Pressure Testing the Gas Supply System..... | 24 |
| Mounting the Water Heater..... | 24-25 |
| Installing the Water Heater..... | 26-27 |
| Venting Through Closed Spaces..... | 27-29 |
| Vent Termination Clearance Diagram..... | 29-31 |
| Installing the Water Heater, Continued..... | 31-32 |
| Hardwiring the Electrical Connections..... | 32 |
| Electrical Connection..... | 33-35 |
| Product features..... | 36 |
| Lighting The Water Heater..... | 36 |
| Operating The Water Heater..... | 36 |
| Operating instruction..... | 37-39 |
| Water Temperature Setting..... | 39-40 |
| Care And Cleaning Of The Water Heater..... | 41-43 |
| Not Equipped With Anti-freezing Protection..... | 43-44 |
| Care And Cleaning Of The Water Heater..... | 44-45 |
| Replacement Parts And Drawing..... | 45-49 |
| Ranein, Enjoy Life!..... | 49-50 |

Important Safety Information: Read All Instructions Before Using

Be sure to read and understand the entire Use and Care Manual before attempting to install or operate this water heater. It may save you time and money. Pay particular attention to the Safety Instructions. Failure to follow these warnings could result in serious bodily injury or death. If you have trouble understanding the instructions in this manual or have any questions, STOP, and seek help from a qualified service technician or your local gas utility.



⚠ DANGER

PrProper Installation of the Water Heater

Failure to properly install the water heater indoors, as outlined in the Installation Instructions in this manual, can result in unsafe operation. To avoid the risk of fire, explosion, or asphyxiation from carbon monoxide, never operate the water heater unless it is installed properly and has an adequate air supply for safe operation. Be sure to inspect the flue terminal for proper installation at initial start-up and at least annually thereafter. Refer to the Care and Cleaning section of this manual for more information on flue terminal inspection.

⚠ WARNING

Gasoline, along with other flammable materials and liquids (such as adhesives, solvents, paint thinners, etc.), and the vapors they produce, are extremely dangerous. Do NOT handle, use, or store gasoline or any other flammable or combustible materials near the water heater or any other appliance. Be sure to read and follow the labels on the water heater, as well as the warnings in this manual. Failure to do so can result in property damage, bodily injury, or death.

Vapors from flammable liquids can explode and ignite, causing death or severe burns.

Do not use or store flammable products, such as gasoline, solvents, or adhesives, in the same room or area as the water heater.

Keep flammable products:

1. Far away from the heater
2. In approved containers
3. Tightly closed
4. Out of children's reach

The water heater has a main burner flame. The main burner flame:

1. Can come on at any time and any where
2. Will ignite flammable vapors

Vapors:

1. Cannot be seen
2. Are heavier than air
3. Go a long way on the floor
4. Can be carried from other rooms to the main burner flame by air currents

Installation:

Do not install the water heater where flammable products will be stored or used unless the main burner flame is at least 18 inches above the floor. This will reduce, but not eliminate, the risk of vapors being ignited by the main burner flame.

Read and follow the water heater warnings and instructions. If the owner's manual is missing, contact the retailer or manufacturer.

⚠️ WARNING

California Proposition 65:

This appliance contains chemicals known to the State of California to cause cancer, birth defects, or other reproductive harm.

If the information in these instructions is not followed exactly, a fire or explosion may result, causing property damage, personal injury, or death.

Do not discard this manual. Please read carefully and keep it in a safe place for future reference.

⚠️ WARNING

- This water heater is not approved for use in manufactured (mobile) homes. Please check local code restrictions pertaining to permanent/fixed installations in manufactured homes in your area.
- Improper installation, adjustment, alteration, service, or maintenance can cause death, personal injury, or property damage. Refer to this manual. Installation and service must be performed by a qualified installer, service agency, or the gas supplier.

Read All Instructions Before Using

Be sure to read and understand the entire Use and Care Manual before attempting to install or operate this water heater. It may save you time and money. Pay particular attention to the Safety Instructions. Failure to follow these warnings could result in death or serious bodily injury.

Should you have problems understanding the instructions in this manual, or have any questions, STOP and get help from a qualified service technician or the local gas utility.

⚠️ DANGER

Properly Install the Water Heater

Failure to properly install the water heater indoor as outlined in the installation instructions in this manual can result in unsafe operation of the water heater. To avoid the risk of fire, explosion, or asphyxiation from carbon monoxide, never operate this water heater unless it is installed properly and has an adequate air supply for proper operation. Be sure to inspect the flue terminal for proper installation at initial start-up and at least annually thereafter.

- Combustible construction refers to adjacent walls and ceilings and should not be confused with combustible or flammable products and materials. Combustible materials, such as clothing, cleaning materials, or flammable liquids, should never be stored in the vicinity of this water heater or any gas appliances. Fire or explosion can occur, causing death, personal injury, and/or property damage.

⚠️ NOTICE

When this water heater is supplying general-purpose hot water requirements for use by individuals, a thermostatically controlled mixing valve for reducing point-of-use water temperature is recommended to reduce the risk of scald injury. Contact a licensed plumber or the local plumbing authority for further information.

⚠ CAUTION

This water heater must only be used with the following water supply system conditions:

- With clean, potable water free of corrosive chemicals, sand, dirt, or other contaminants.
- With inlet water temperature above 32°F (0°C), but not exceeding 118°F (48°C).
- DO NOT reverse the hot and cold water connections. The water heater will not operate.

⚠ DANGER

NATURAL GAS AND LIQUEFIED PETROLEUM MODELS SAFETY

Both propane and natural gas have odorants added to aid in detecting a gas leak. Some people may not physically be able to smell or recognize these odorants. If you are unsure or unfamiliar with the smell of propane or natural gas, ask the gas supplier.

Other conditions, such as "odorant fade," which causes the odorant to diminish in intensity, can also hide or camouflage a gas leak. Always check with commercial leak detectors or soapy water.

- Gas detectors are recommended for propane and natural gas applications, and their installation should be in accordance with the detector manufacturer's recommendations and/or local laws, rules, regulations, or customs.
- Water heaters utilizing propane gas differ from natural gas models. A natural gas water heater will not function safely on propane gas and vice versa.
- No attempt should ever be made to convert the water heater from natural gas to propane gas. To avoid possible equipment damage, personal injury, or fire, do not connect the water heater to a fuel type not in accordance with the unit data plate; propane for propane units and natural gas for natural gas units. These units are not certified for any other fuel type.
- Propane water heaters should not be installed below grade (for example, in a basement) if such installation is prohibited by federal, state, and/or local laws, rules, regulations, or customs.
- Propane or propane gas must be used with great caution. It is heavier than air and will collect first in lower areas, making it hard to detect at nose level. Before attempting to light the water heater, make sure to look and smell for gas leaks. Use a soapy solution to check all gas fittings and connections. Bubbling at a connection indicates a leak that must be corrected. When smelling to detect a gas leak, be sure to sniff near the floor as well.
- It is recommended that more than one method, such as a soapy solution, gas detectors, etc., be used to detect leaks in gas applications.

NOTICE : If a gas leak is present or suspected:

- DO NOT attempt to identify the cause yourself.
- DO NOT try to light any appliance. DO NOT touch any electrical switches.
- DO NOT use any phone within the building.
- Leave the house immediately, and ensure that your family and pets leave as well.
- Leave the doors open for ventilation and contact the gas supplier, a qualified service agency, or the fire department.
- Stay away from the house (or building) until a service call has been made, the leak has been corrected, and a qualified agency has determined the area is safe.
- Follow the steps listed under 'WHAT TO DO IF YOU SMELL GAS' on Page 9 of this manual.

⚠ WARNING

- The installation of gas piping must comply with local utility company requirements and/or, in the absence of local codes, the latest edition of the National Fuel Gas Code (NFGC), ANSI Z223.1/NFPA 54.
- If the inlet gas pressure is outside the allowable range (8.0" w.c. (2.0 kPa) to 13.0" w.c. (3.2 kPa) for propane gas), a gas pressure regulator must be installed to maintain the proper inlet gas pressure.
- In the event of overheating or if the gas supply fails to shut off, turn off the manual gas control valve to the water heater immediately.

⚠ CAUTION

- Do NOT attempt to repair electrical wiring, gas piping, burners, vent connectors, or other safety devices. Refer repairs to qualified service personnel.
- Turn off the manual gas shut-off valve if the water heater has been subjected to overheating, fire, flood, physical damage, or if the gas supply fails to shut off.
- DO NOT turn on the water heater unless both the water and gas supplies are fully opened.

For Your Safety, Read Before Operating

⚠ WARNING

Failure to follow these instructions exactly could result in a fire or explosion, causing property damage, personal injury, or loss of life.

A. This appliance does not have a pilot. It is equipped with an ignition device that automatically lights the burner. Do not attempt to light the burner by hand.

B. Before operating, check for the smell of gas around the appliance. Be sure to check near the floor, as some gases are heavier than air and will settle on the floor.

WHAT TO DO IF YOU SMELL GAS:

- DO NOT attempt to light any appliance.
- DO NOT touch any electrical switches and DO NOT use any phones within the building. Immediately call your gas supplier from a neighbor's phone and follow their instructions.
- If you cannot reach your gas supplier, call the fire department.
- DO NOT return to your home until you have been authorized to do so by the gas supplier or fire department.

C. Use only your hand to push in or turn the gas control knob. Never use tools. If the knob does not push in or turn by hand, do not attempt to repair it. Contact a qualified service technician. Forcing or attempting to repair the knob may result in a fire or explosion.

D. Do not use this appliance if any part has been submerged in water. Immediately call a qualified service technician to inspect the appliance and replace any part of the control system or gas control that has been exposed to water.

Operating Instructions

1. STOP! Read the safety information provided in this manual.
2. Turn off all electric power to the appliance.
3. Do not attempt to light the burner by hand.
4. Turn the gas shut-off valve located on the outside of the unit clockwise to the "OFF" position.

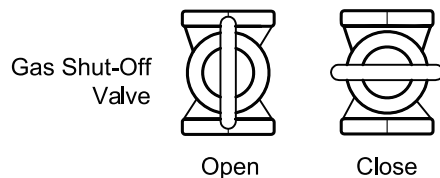

5. Turn off all electric power to the appliance (repeated for emphasis).
6. Wait five (5) minutes to clear out any gas. If you smell gas, STOP! Follow the "B" instructions in the safety information above in this manual. If you do not smell gas, proceed to the next step.
7. Turn the gas shut-off valve located on the outside of the unit counterclockwise to the "ON" position.
8. Turn on all electric power to the appliance.
9. Set the thermostat to the desired setting.
10. If the appliance does not operate, follow the instructions under "To Turn Off Gas to Appliance" and contact your service technician or gas supplier.

To Turn Off Gas to Appliance

1. Turn off all electric power to the appliance if service is to be performed.
2. Turn the gas shut-off valve located on the outside of the unit clockwise to the "OFF" position.

Electrical safety

⚠ DANGER

Shock hazard: Make sure the electrical power to the water heater is off to avoid electric shock, which could result in death or serious personal injury.

⚠ WARNING

- For your safety, the information in this manual must be followed to minimize the risk of fire, explosion, or electric shock, which can result in death, personal injury, and/or property damage.
- Field wiring connections and electrical grounding must comply with local codes or, in the absence of local codes, with the latest edition of the National Electrical Code, ANSI/NFPA 70.

⚠ CAUTION

- Label all wires prior to disconnecting for service. Wiring errors can cause dangerous and improper operation. Verify correct operation after servicing.
- For your safety, burner inspection and cleaning should only be performed by qualified service personnel.
- Ensure the power to the water heater is OFF before removing the unit cover panel. Exposed electrical components and moving parts can cause personal injury.
- For your safety, DO NOT attempt to repair electrical wiring, gas piping, burners, vent connectors, or other safety devices. Refer all repairs to qualified service personnel.

For Installations in the State of California

California law requires that residential water heaters must be braced, anchored, or strapped to resist falling or horizontal displacement due to earthquake motions.

This applies to residential water heaters with a capacity of up to 52 gallons.

However, applicable local codes shall govern the installation. For residential water heaters with a capacity greater than 52 gallons or for tankless models, consult the local building code for acceptable bracing procedures.

Safety Precautions

Have the installer show you the location of the gas shut-off valve and demonstrate how to turn it off if necessary. Turn off the manual shut-off valve if the water heater has been subjected to overheating, fire, flood, physical damage, or if the gas supply fails to shut off.

- Read this manual thoroughly before installing or operating the water heater.
- Use this appliance only for its intended purpose as described in this Use and Care Manual.
- Ensure your appliance is properly installed in accordance with local codes and the provided installation instructions.
- Do not modify any part of your water heater unless specifically recommended in this manual.
- All other servicing should be performed by a qualified technician.

Installing the Water Heater

Indoor location

- Installation distances may vary based on local codes. It is the installer's responsibility to verify installation requirements.
- Before installation, ensure that the gas type to be used matches the type listed on the data plate.
- The water heater should be installed by professionals. Improper installation may lead to failure or dangerous conditions, such as gas leaks or explosions.
- The water heater cannot be installed in an UNVENTED bathroom, bedroom, basement, living room, closet, outdoor area, stairway, or an exit area. If installed in an exit area, it must be at least 16.5 ft away from the exit.
- The vent pipe should extend at least 2" from the wall. The terminal must be at least 1.64 ft away from any obstruction and must be well-vented.
- The vent pipe should slope 3° downward to prevent water condensation and protect against rain entry.
- The vent pipe should avoid direct, strong winds, as downdrafts may cause malfunction.

- The unit should be installed away from any obstructions, with sufficient space for installation and maintenance. Adequate clearances for servicing must be provided.
- The unit should not be installed in the same room as a gas stove.
- When determining the floor clearance, a minimum of 6" must be maintained between the vent pipe and combustible materials. Additionally, a 6" clearance from the side walls and a 12" clearance from the top must be maintained.
- The vent pipe can be up to 32 feet in length, with one elbow.
- The vent pipe should be installed with a flame-retardant wall thimble. The owner must refer to the vent manufacturer's instructions and specifications.
- The power socket connecting the water heater should be properly grounded and equipped with a GFCI circuit protector.
- The water heater should not be located in an area where leakage from the heat exchanger or connections could cause damage to adjacent areas or to lower floors of the structure. If such areas cannot be avoided, it is recommended that a suitable catch pan, adequately drained, be installed under the water heater.
- The pan must not restrict combustion airflow. The water heater should be installed as close as possible to the vent termination to minimize vent length and the number of elbows required for venting.
- A gas-fired water heater or any other appliance should not be installed in a space where liquids that give off flammable vapors are used or stored. Such liquids include gasoline, propane (butane or propane), paint, adhesives, and their thinners, solvents, or removers.
- The unit should be installed away from heat sources, as well as flammable and hazardous materials. Due to natural air movement in a room or other enclosed space, flammable vapors can be carried some distance from where these liquids are being used or stored. The open flame of the water heater's main burner can ignite these vapors, causing an explosion or fire that may result in severe burns, death, or property damage.
- Raising the water heater will reduce, but not eliminate, the possibility of igniting the vapor of any flammable liquids that may be improperly stored or accidentally spilled.
- If the water heater is installed in a garage, it should be placed so that the direct ignition system and main burner are at least 18" above the garage floor.
- Hot and cold water lines should be insulated to improve water and energy conservation.
- The water heater must be located in an area where it is not subject to physical damage, such as from moving vehicles, flooding, or other hazards.
- The water heater should be installed with the proper venting materials and terminations suitable for Category III venting. Failure to properly install and vent the water heater to the outdoors, as outlined in the Venting Section of this manual, can result in unsafe operation. The owner must refer to the vent manufacturer's instructions and specifications.

- For appliances other than direct vent models, the appliance must be located as close as possible to a chimney or gas vent.
- DO NOT install the water heater where it may be subject to vibrations or on the road.
- DO NOT install the water heater in Recreational Vehicles, Mobile Homes, Boats, or other Watercraft.
- DO NOT install the water heater near vents for heating or cooling. A minimum clearance of 4 feet must be maintained.
- If the clearances are specified on the instruction/warning label located on the front panel of the heater, install the water heater according to the clearances provided in the manual.

⚠ WARNING

Combustible construction refers to adjacent walls and ceilings and should not be confused with combustible or flammable products and materials. Combustible and/or flammable products and materials should never be stored in the vicinity of this or any gas appliance.

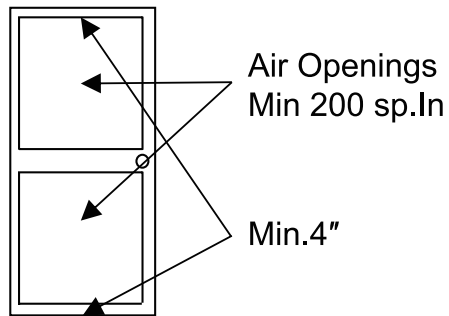

Proper operation of the water heater requires air for combustion and ventilation. Provisions for combustion and ventilation air must comply with the relevant codes.

Combustion and Ventilation Air:

A confined space is one having a volume of less than 50 cubic feet per 1,000 BTU/hr of the aggregate input of all appliances within that space.

The air must be supplied through two permanent openings of equal area. One should be located within 12 inches above the floor and the other within 12 inches below the ceiling. The minimum net free area of each opening must not be less than one square inch per 1,000 BTU/hr of the total input rating of all the appliances in the enclosure (but not less than 100 square inches), provided each opening communicates with other unconfined areas inside the building.

Buildings of unusually tight construction shall have the combustion and ventilation air

supplied from outdoors or from a freely ventilated attic or crawl space. If air is supplied from outdoors, either directly or through vertical ducts, there must be two openings located as specified above, with each having a minimum net free area of not less than one square inch per 4,000 BTU/hr of the total input rating of all the appliances in the enclosure. If horizontal ducts are used to communicate with the outdoors, each opening must have a minimum net free area of not less than one square inch per 2,000 BTU/hr of the total input rating of all the appliances in the enclosure. If ducts are used, the minimum dimensions of rectangular air ducts must not be less than 4 inches.

⚠ NOTICE

If the water heater is installed in an unconfined space within a building of conventional frame, masonry, or metal construction, infiltration air is normally adequate for proper combustion and ventilation. If the water heater is installed in a confined space, provisions for combustion and ventilation air must be made.

⚠ NOTICE

If the duct openings that supply combustion and ventilation air are to be covered with a protective screen or grill, the net free area (openings in the material) of the covering material must be used in determining the size of the openings. The protective screening for the openings must not be smaller than 1/4 inch to prevent clogging by lint or other debris.

Corrosive Atmospheres

The air in beauty shops, dry cleaning establishments, photo processing labs, and storage areas for liquid and powdered bleaches or swimming pool chemicals often contains such halogenated hydrocarbons.

An air supply containing halogenated hydrocarbons may be safe to breathe, but when it passes through a gas flame, corrosive elements are released that can shorten the life of any gas-burning appliance.

Propellants from common spray cans or gas leaks from A/C and refrigeration equipment are highly corrosive after passing through a flame.

The water heater warranty is voided if the heater fails due to operation in a corrosive atmosphere.

⚠ NOTICE

The water heater should not be installed near any air supply containing halogenated hydrocarbons.

Water Supply Connections

Plumbing should be carried out by a qualified plumber in accordance with local codes. Only approved plumbing materials and tools should be used.

Install a check valve between the water heater and the water shut-off valve.

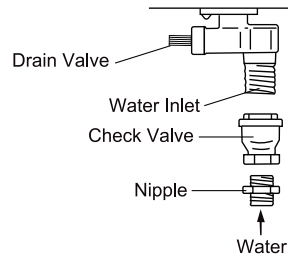

To conserve energy and prevent freezing, insulate both the cold and hot water supply lines. DO NOT cover the drain valves. Install a shut-off valve near the inlet of the water heater for servicing and draining purposes. Before connecting the water supply pipe to the water heater, open the shut-off valve and clean out any sand, debris, air, caulking material, etc., inside the pipe. Once cleaned, connect the pipe to the water inlet and check for water flow. Close the shut-off valve and clean the water filter.

If the water heater is installed in a closed water supply system, such as one that includes a backflow preventer in the cold water supply line, provisions must be made to control thermal expansion. Contact the water supplier or local plumbing inspector for guidance on how to manage this issue.

To ensure proper operation of the water heater, the following water pressure guidelines should be followed:

- The operation of the water heater requires a minimum water pressure of 14 PSI and a minimum water flow rate of 0.75 GPM.
- Additional water pressure is needed for long pipe runs and any outlet fittings where water pressure may drop.
- To maintain proper performance, ensure sufficient water supply pressure. The required water pressure should be calculated as: Required Water Pressure = Min. Operating Water Pressure (14 PSI) + Pipe Pressure Loss + Faucet and Shower Pressure Loss + Safety Margin (more than 5 PSI).
- To supply hot water to upper floors, additional water pressure (0.44 PSI per foot) must be ensured.
- The measurement should be calculated by the distance from the water inlet of the water heater (ground level) to the hot water faucet (upper floor level).
- Well water systems should be set at a range of 50-60 PSI.
- When water is supplied from a water supply tank, the height of the tank, the diameter of the pipes, and their relation to water pressure should be considered. Gravity-fed water pressure is not recommended.

IMPORTANT: Do not apply heat to the HOT or COLD water connections. Any heat applied to the water supply fittings will permanently damage the internal components of the water heater.

In regards to the hot water outlet:

- Connections between the water heater and point(s) of use should be as short and direct as possible.
- DO NOT use lead or non-approved plastic pipe.
- To conserve energy and minimize heat loss, insulation of hot water piping is recommended.

⚠ NOTICE

If using mixing valves on the outlet, choose one that prevents cold water pressure from overcoming hot water line pressure.

DO NOT use pipes with smaller diameters than the water supply connection of the water heater.

Be sure to connect the water inlet and the hot water outlet as shown on the water heater. If reversed, the water heater will not function.

Installation of unions or flexible copper connections is recommended on the HOT and COLD water lines, so that the water heater may be disconnected easily for servicing if necessary.

⚠ NOTICE

If the water flow resistance of a shower head is too high, the burner in the water heater may fail to ignite. Keep the shower head clean from debris that could cause additional pressure drop.

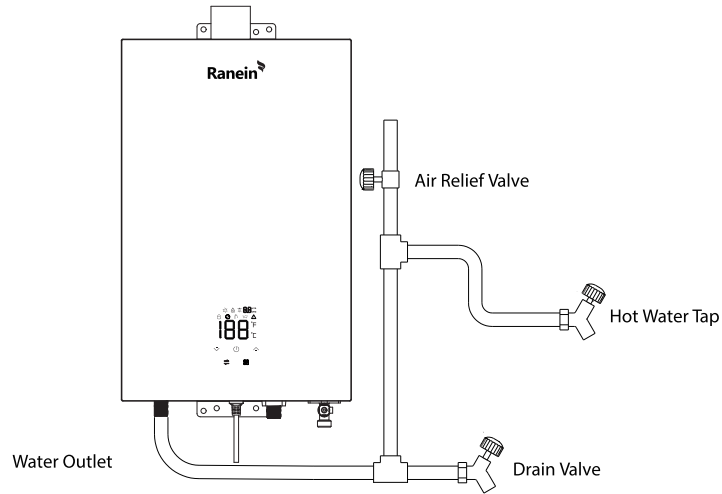

⚠ NOTICE

The flow rate of hot water may vary when more than two faucets (appliances, fixtures, etc.) are being used simultaneously.

NOTICE: The pipes **MUST** be completely drainable. If the hot water faucets are located at a point higher than the water heater, place a drain valve at the lowest point (see diagram to the left).

Relief Valve

A new pressure relief valve, complying with the Standard for relief Valves and Automatic Gas shut off Devices for hot water supply systems, ANSI Z21.22, must be installed at the hot water outlet connection of the water heater at the time of installation. Local codes shall govern the installation of relief valves.

For safe operation of the water heater, ensure that:

- The pressure rating of the relief valve must not exceed 150 PSI, the maximum working pressure of the water heater as marked on the rating plate.
- The BTU/Hr rating of the relief valve must equal or exceed the BTU/Hr input of the water heater as marked on its rating plate.
- No valve of any type should be installed between the relief valve and the water heater.
- Discharge from the relief valve should be piped to a suitable drain to eliminate potential water heater damage. Piping used should be of a type approved for the distribution of hot water.
- Hot and cold water lines should be insulated up to the water heater.

- The discharge line must be **NO SMALLER** than the outlet of the valve and must pitch downward to allow complete drainage (by gravity) of the relief valve and discharge line.
- The end of the discharge line should not be threaded

⚠ NOTICE

The diagram below illustrates a pressure-only relief valve. If local codes require a combination temperature and pressure relief valve to be installed, an extension piece may be needed.

⚠ NOTICE

Manual operation of relief valves should be performed at least once a year. Turn off the electrical power and gas shut-off valve. Lift and release the lever on the relief valve and check the manual operation of the relief valve. You should take precautions to avoid contact with the hot water coming out of the relief valve and to prevent water damage.

⚠ NOTICE

If the relief valve on the system discharges periodically, this may be due to thermal expansion in a closed water supply system. Contact the water supplier or local plumbing inspector for advice on how to correct this situation. Do not plug the relief valve.

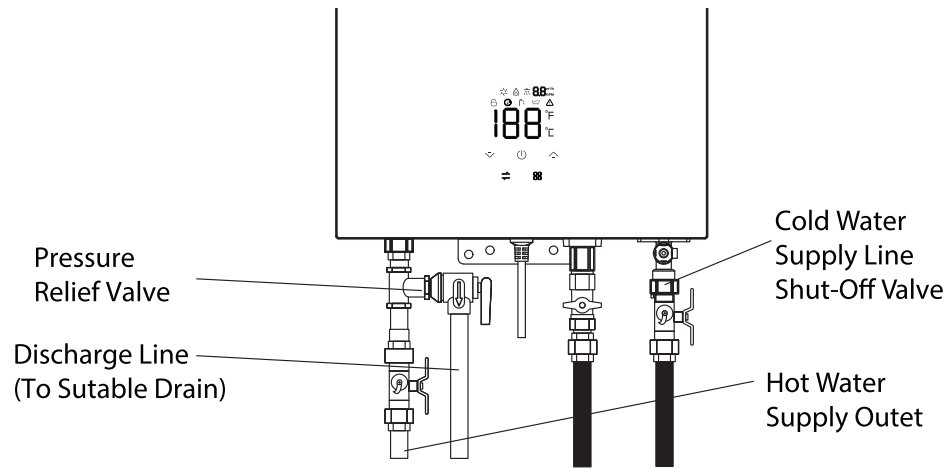

Gas Supply

⚠ WARNING

Do not attempt to convert this water heater for use with a different type of gas than the one indicated on the rating plate. Such conversion could lead to hazardous operating conditions. Please have a professional install the gas connection.

The manual gas appliance shut-off valve must be installed at the gas connection of the water heater at the time of installation.

The branch gas supply line to the water heater should be clean black steel pipe or other approved gas piping material. A ground joint union or ANSI design certified semi-rigid or flexible gas appliance connector should be installed in the gas line close to the water heater.

The National Fuel Gas Code (NFGC) mandates a manual gas shut-off valve. See NFGC for complete instructions.

DO NOT use excessive force (over 31.5 ft lbs) in tightening the pipe, particularly if pipe compound is used, as the unit may be damaged.

Compound used on the threaded joints of the gas piping must be of the type resistant to the action of propane gas. Use compound sparingly and only on male threads.

A sediment trap should be installed at the bottom of the gas line.

The inlet gas pressure to the water heater must not exceed 12.4" w.c for propane gas. For purposes of input adjustment, the minimum inlet gas pressure (with main burner on) is shown on the water heater rating plate. If high or low gas pressures are present, contact your gas supplier for correction.

The appliance and its individual shut-off valve must be disconnected from the gas supply piping system during any pressure testing of that system at test pressures in excess of 1/2 PSI (3.5 kPa).

The appliance must be isolated from the gas supply piping system by closing its individual manual shut-off valve during any pressure testing of the gas supply piping system at test pressures equal to or less than 1/2 PSI (3.5 kPa).

Water Heater Installation Checklist

- Unbox and check whether the water heater, installation manual, owner's guide, parts, and accessories bag are included in the box.
- Ensure there are no corrosive chemicals in the air intake.
- The water supply should be free of chemicals, and water hardness exceeding the allowed level may damage the water heater.
- Ensure there is enough space required for installation.
- Ensure there is enough distance between the exhaust vent and the air inlet of houses.
- Use the correct exhaust vent products and follow the installation manual provided by the supplier.
- For indoor water heater models, ensure the number of elbows used does not exceed the maximum quantity allowed, and the total length of the exhaust vent pipe (including elbows, each equivalent to 6 feet) does not exceed the maximum length allowed for the water heater.
- For indoor water heater models, ensure the exhaust vent pipe slopes outward and downward at an angle of 3 degrees.
- Turn off the hot water switch, turn on the cold water switch and the drain screw to flush debris and air out of the water pipes. Debris inside the water may damage the water heater. Use buckets or extra water pipes if needed.
- Ensure there are no water leakages.
- Turn off the cold and hot water switches before cleaning the water inlet filter. Place a bucket under the water heater's filter to catch any water. Screw out the water inlet filter, wash off debris and dust, then hand-screw the filter back in. Once done, turn on the cold and hot water switches.
- Ensure the pressure relief valve's relieving capacity exceeds that of the water heater BTU input rating. Refer to the specifications on the side of the machine for BTU input ratings.
- Install a manual gas shut-off valve between the water heater and your gas supply line.

- Confirm there is no gas leakage in the piping and fittings.
- Confirm the gas inlet pressure is within the min-max range as required.
- Ensure you are using the gas type required by the water heater.
- Confirm the power supply is 120 V/60 Hz and properly grounded.
- Confirm the thermostat works normally.
- Connect a gas manometer to the pressure port to verify the system is working normally. Turn on appliances that use high flow rate hot water and set the water heater to its maximum operation capacity; the inlet gas pressure must be higher than the minimum pressure on the specification label.
- Do not introduce poisonous chemicals into drinking water, such as those used to process broiler water.
- Drain the water from the water heater if it will not be used for an extended period.

Product Parameters

| | | |
|-------------------------------------|----------------------|----------------------|
| Model No. | RH8KG | RH11KG |
| Voltage | 120 Volts | 120 Volts |
| Frequency | 60 Hz | 60 Hz |
| Amps | Less than 12 Amperes | Less than 12 Amperes |
| Maximum Input Rating (Btu per hour) | 78,500 | 116,000 |
| Minimum Input Rating (Btu per hour) | 13,600 | 17,000 |
| Rated heat load | 23 kW | 34 kW |
| Rated hot water production capacity | 12kg/min | 18kg/min |
| Gas Supply Pressure | Natural Gas | 6.0"-8" W.C |
| | Propane | 9.8"-12.4" W.C |
| Maximum Working Pressure | 150 PSI | 150 PSI |
| Water pressure | 0.025~0.8 MPa | 0.025~0.8 MPa |
| Rated electric power | 30 W | 34 W |
| Anti-freezing heater power | 100 W | 114 W |
| Body size | 21.7"×13.8"×6.8" | 21.7"×13.8"×7.13" |

Prepare for Installation

Parts included



Ranein Tankless Water Heater



User's Manual

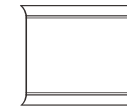

Assembly Kit

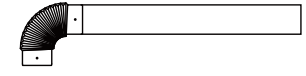

Vent pipe

Tools needed (Not included)



Screw Driver

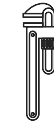

Pipe Wrench



Wrench

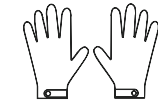

Gloves



Safety Glasses

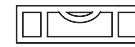

Levelling Instrument

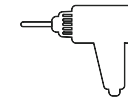

Hammer Drill With Concrete Bits

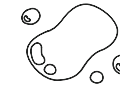

Soapy Water



Gas Leak Detector



Ruler

Materials needed (Not included)

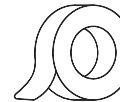

Teflon Tape

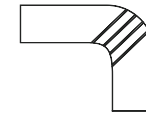

Approved Venting



Pressure Relief Valve

Materials that may be needed (Not included)

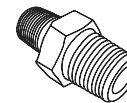

1/2" Hex Nipple

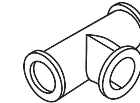

Threaded Tee Fitting (Middle 3/4")

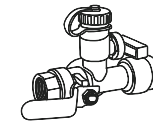

Hot Water Isolation Valve



Cold Water Isolation Valve

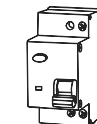

Single gang electrical box



Electrical Adhesive Tape

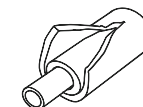

Pipe Wrap Insulation

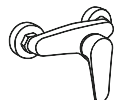

Thermostatic Mixing Valve

Installing the Water Heater

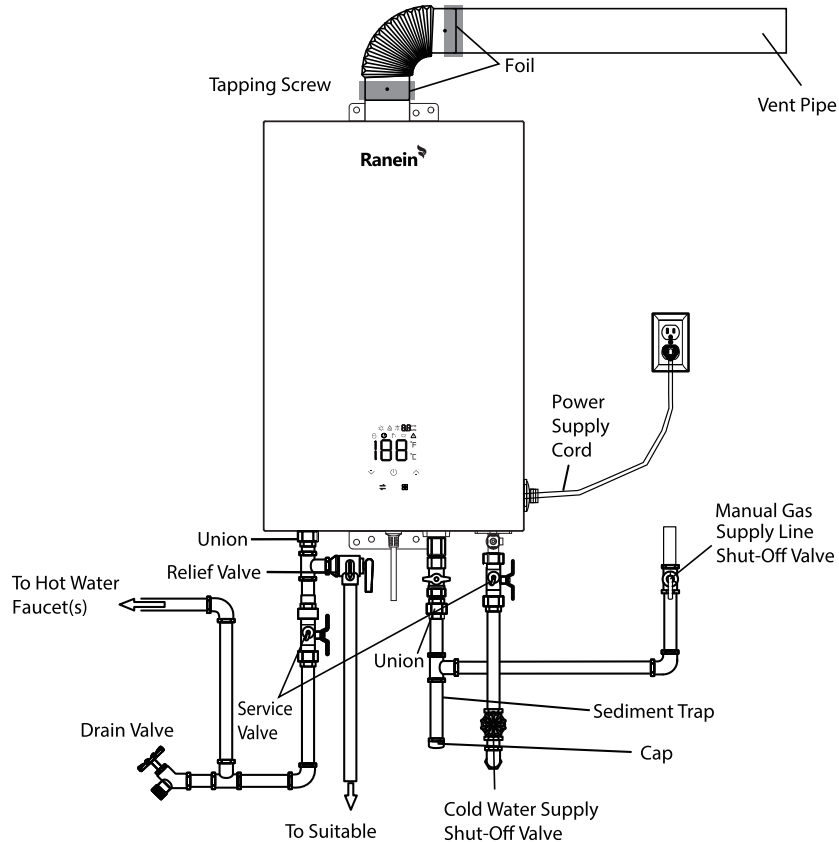

***Note: A flexible drain tube can be used**

▲ NOTICE

The National Fuel Gas Code (NFGC) mandates a manual gas shut-off valve. Refer to the NFGC for complete instructions. Local codes or plumbing authority requirements may differ from the instructions or diagrams provided and shall take precedence over these instructions.

For Use at High Altitudes

Gas appliance ratings are based on sea level operation and do not require adjustment for installations at elevations up to 2,000 feet (600 meters). The unit is not recommended for elevations exceeding 2,000 feet (600 meters).

Pressure Testing the Gas Supply System

▲ WARNING

Install a gas pressure regulator in the gas supply line that does not exceed the maximum supply pressure. DO NOT use an industrial-type gas regulator. The water heater must be isolated from the gas piping system by closing the manual gas shut-off valve during any pressure testing of the gas supply piping at pressures equal to or less than 1/2 PSI (3.5" w.c.).

Leak Testing

▲ WARNING

Never use an open flame to test for gas leaks, as it could result in property damage, personal injury, or death. The water heater and its gas connections must be leak-tested at normal operating pressures before being placed in operation. Turn on the gas shut-off valve(s) to the water heater. Use a commercial leak detector or a soapy water solution to test for leaks at all connections and fittings. Bubbles will indicate a gas leak that must be corrected. All connections should also be leak-tested after the water heater is in operation.

Mounting the Water Heater

Ensure that the location of the appliance allows for easy access and operation. For drywall or concrete walls, use drywall anchors or lag bolts. The water heater requires a 120VAC/60Hz power supply. Make sure there is a grounded receptacle near the water heater. The power supply cord is 5 feet in length. Drill holes according to the sizes indicated in the figure to the left. Insert one expansion screws into the top holes and two rubber screws into the bottom holes.

▲ CAUTION

Reinforcement of the wall is required if the wall is not strong enough to support the appliance. The indoor unit must be installed with a Category III vent pipe, in accordance with the vent supplier/manufacturer instructions and local codes.

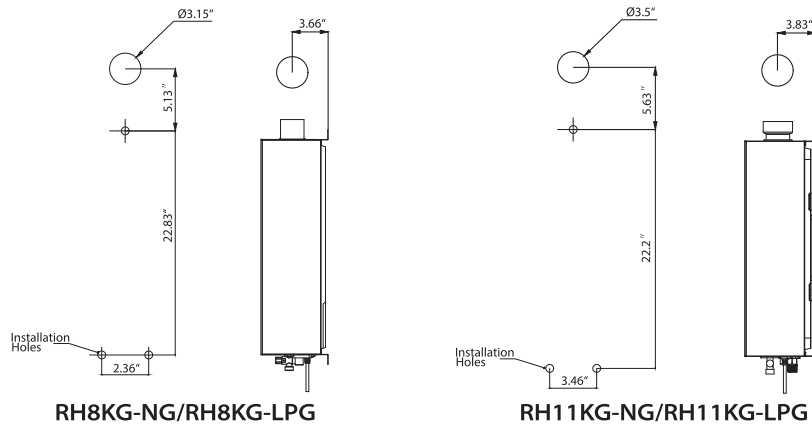

RH8KG-NG/RH8KG-LPG

RH11KG-NG/RH11KG-LPG

A. BACK INSTALLATION

1. Insert the vent pipe through the installation holes in the wall, ensuring the terminal protrudes outward.
2. Connect the elbow to the vent pipe and the water heater, moving it straight backward until the expansion screws align with the holes in the water heater. Tighten the nuts (be sure to check the direction of the elbow).

B. SIDE INSTALLATION

1. Aim the holes in the water heater at the expansion screws, hang the unit, and tighten the nuts securely.
2. Insert the vent pipe through the wall holes, then connect the elbow to both the water heater and the vent pipe.

C. VERTICAL INSTALLATION

- Please consult a local installation professional or venting manufacturer: The installation hole in the wall must be sealed with fire-retardant materials or a wall thimble, ensuring the water heater is securely mounted and will not become loose.

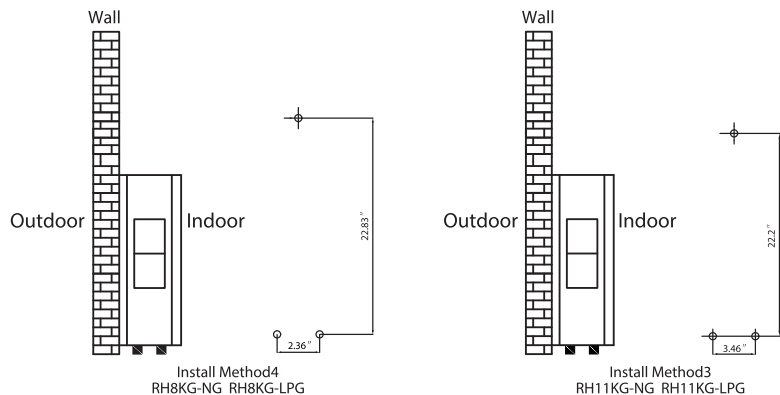

Install Method 4
RH8KG-NG RH8KG-LPG

Install Method 3
RH11KG-NG RH11KG-LPG

Installing the Water Heater

⚠ DANGER

Failure to install the vent adapter and properly vent the water heater to the outdoors, as outlined in the venting section of this manual, will result in unsafe operation, potentially causing death, serious injury, explosion, or fire. To avoid the risk of fire, explosion, or asphyxiation from carbon monoxide, NEVER operate the water heater unless it is properly vented and has an adequate air supply, as specified in the venting section of this manual.

⚠ WARNING

Use only UL-approved Category III stainless steel vent material. No other vent material is permitted.

Venting

The installation of venting must comply with national codes, local codes, and the vent manufacturer's instructions.

The water heater must be vented to the outdoors as described in these instructions.

DO NOT connect this water heater to an existing vent or chimney; it must be vented separately from all other appliances.

All vent components (adapters, pipe, elbow, terminals, etc.) should be UL 1738 Certified stainless steel venting materials (e.g., AL29-4C).

The specified vent termination must be used. The termination should be a 90-degree elbow type with a screen.

Use a vent pipe with an anti-disconnection structure.

The use of high-temperature silicone (500°F/260°C) may be required to seal vent connections. To prevent accidental gas exhaust leakage, apply a 1/4" wide bead approximately 1/4" from the end and another bead against the joint side of the stop bead.

Follow the vent manufacturer's installation instructions.

The unit can be vented either horizontally or vertically.

Vent pipe runs must be adequately supported along both horizontal and vertical runs.

The maximum recommended unsupported span should be no more than 5 feet.

Support isolation hanging bands should be used. DO NOT use wire (See diagram below).

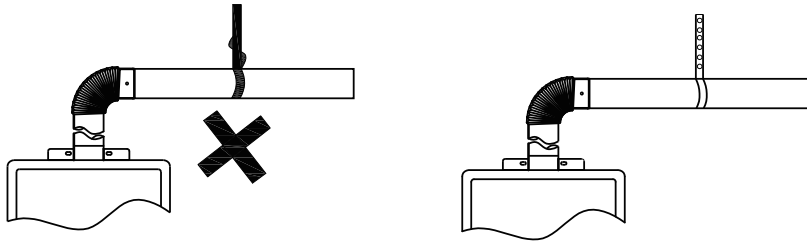

Venting Through Closed Spaces

If the vent piping passes through a closed space, wrap the vent pipe with non-combustible insulation material that is at least 3/4" thick. DO NOT allow the insulation material to come into contact with flammable materials. Maintain a minimum clearance of 6" between the vent pipe and the ceiling. Follow local codes. For maintenance and inspection purposes, the following openings must be made:

TWO (2) inspection openings to allow access to the venting system. One opening should be near where the vent pipe enters the ceiling, and the other should be near the vent termination.

A ventilation hole with a 16 sq. in. opening should be made at least every 10 feet.

▲ NOTICE

Vent pipes must be fully insulated with non-combustible material when installed in alcoves, closets, and garages, and must not come into contact with any flammable material.

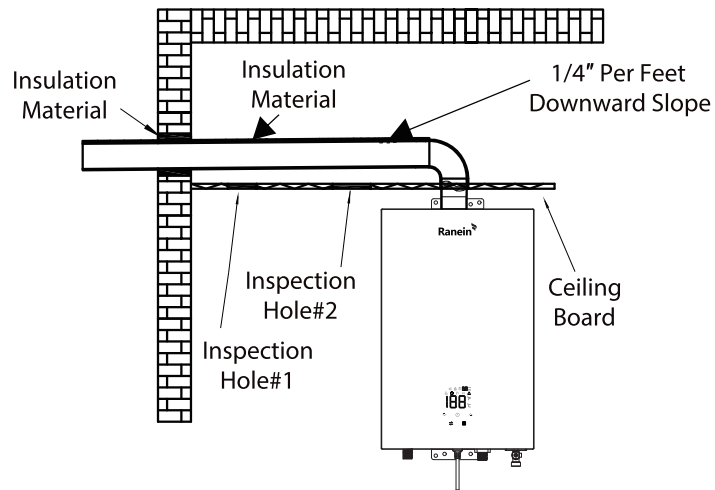

Venting Lengths

Maximum vent length

Owner must refer to vent manufacturer's instructions and specifications.

| Number of 90° elbows(Bends) | Maximum length of straight pipe |
|--|---------------------------------|
| 1 | 32" |
| 2 | 27" |
| 2 | 22" |
| One(1)90° elbow is equivalent to 5 feet of straight pipe | |

The system will not operate if there is excessive restriction (pressure drop) in the venting system. A maximum of 32 feet of vent pipe may be used, provided there is only one 90° elbow in the system. If additional elbows are required:

Two elbows can be used with 27 feet of vent pipe. Three elbows can be used with 22 feet of vent pipe. A 90° elbow is equivalent to 5 feet of straight pipe. A 45° elbow is equivalent to 2 feet 6 inches of straight pipe.

The termination elbow does not count as an elbow when determining total vent length.

The vent must be installed with a slight downward slope of 1/4" per foot of horizontal run toward the vent terminal (see diagram below). This ensures that any condensate formed during the operation of the unit is evacuated from the appliance.

An upward slope of 1/4" per foot is acceptable when a downward slope is not possible; however, a UL-approved Category III stainless steel condensate trap MUST be installed at the beginning of the horizontal run.

Minimum Vent Length

The venting may be as short as 12 inches, provided one vent termination is installed outdoors through a sidewall, one 90° elbow is included in the installation, and the wall thimble is properly installed.

▲ NOTICE

Ensure that the seam of the vent pipe in horizontal runs is positioned toward the top of the installation (see illustration below).

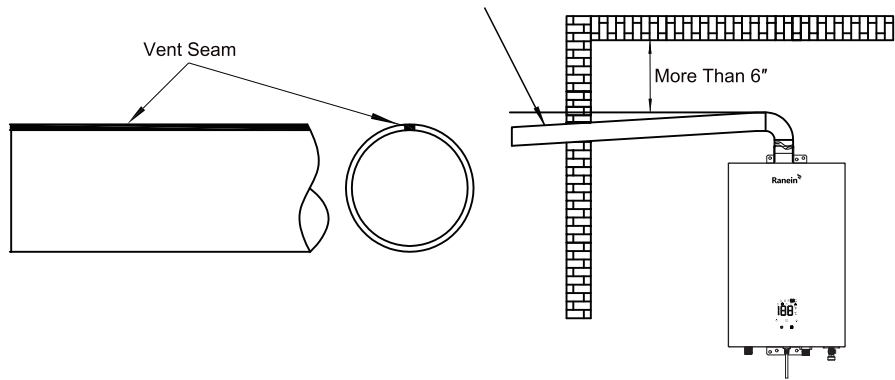

Draining the Condensate

Under certain conditions, installations in unconditioned spaces or with long horizontal or vertical runs may accumulate condensate.

Condensate is acidic; please refer to local, state (provincial), or federal codes for proper handling methods.

To prevent condensate from draining back into the water heater, we recommend installing a condensate trap and drain in the horizontal vent section, as close as possible to the water heater vent connection.

Failure to follow proper condensate procedures will void the warranty.

Vent Termination Clearance Diagram

For non-direct vent installations in the U.S. and Canada

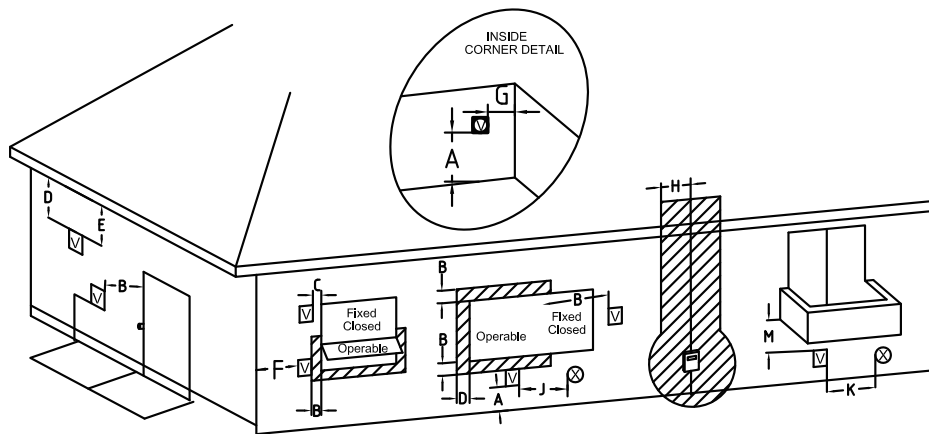

| | | US Installation 1 | Canadian Installation 2 |
|----|---|---|---|
| A= | Clearance above grade, veranda, porch, deck, on balcony | 12 in (30 cm) | 12 in (30 cm) |
| B= | Clearance to window or door that may be opened | 4ft (1.2m) below or to side of opening: 1ft (300mm) above opening | 6 in (15cm) for appliances $\leq 10,000$ Btu/Hr (3kW). 12 in (30cm) for appliances $> 10,000$ Btu/Hr (3kW) and $\leq 10,000$ Btu/Hr (30kW), 36 in (91cm) for appliance $> 10,000$ Btu/Hr (30kW) |
| C= | Clearance to permanently closed window | * | |
| D= | Vertical clearance to ventilated soffit located above the terminal within a horizontal distance of 2 feet (61cm) from the center line in terminal | * | |
| E= | Clearance to unventilated soffit | * | |
| F= | Clearance to outside corner | * | |
| G= | Clearance to inside corner | * | |
| H= | Clearance to each side of center line extended above meter/regulator assembly | * | 3ft (91cm) within a height 15ft above the meter /regulator assembly |
| I= | Clearance to service regulator vent outlet | * | 3 ft (91 cm) |
| J= | Clearance to non-mechanical air supply inlet to building or the combustion air inlet to any other appliance | 4ft (1.2m) below or to side of opening: 1ft (300mm) above opening | 6 in (15cm) for appliances $\leq 10,000$ Btu/Hr (3kW), 12 in (30cm) for appliances $> 10,000$ Btu/Hr (3kW) and $\leq 10,000$ Btu/Hr (30kW), 36 in (91cm) for appliance $> 10,000$ Btu/Hr (30kW) |
| K= | Clearance to mechanical air supply inlet | 3ft (91cm) above if within 10ft (3m) horizontally | 6 ft (1.83 m) |
| L= | Clearance above pave sidewalk or paved driveway located on public property | * | 7 ft (2.13 m) |
| M= | Clearance under veranda, porch, deck or balcony | * | 12 in (30 cm) |

For clearances not specified in ANSI Z223.1/NFPA 54 or CSA-B149.1, one of the following shall be indicated:

- A) A minimum clearance value determined by testing in accordance with Clause 5.20, or
- B) A reference to the following footnote:

Clearance in accordance with local installation codes and the requirements of the gas supplier.

- A vent shall not terminate directly above a sidewalk or paved driveway located between two single-family dwellings, serving both dwellings.
- This is permitted only if the veranda, porch, deck, or balcony is fully open on a minimum of two sides beneath the floor.

⚠ NOTICE

1. In alignment with the current CSA B129.1 propane installation code.
2. In accordance with the current ANSI Z223.1/NFPA 54 National Fuel Gas Code.

Installing the Water Heater, Continued

Pipe Installation

Inlet and Outlet Pipe Installation

Use pressure-resistant pipe to connect the inlet and outlet water pipes of the water heater to the local water supply. Ensure that the rubber ring is properly placed. Before connecting the inlet water pipe, flush the interior of the pipe to remove any debris.

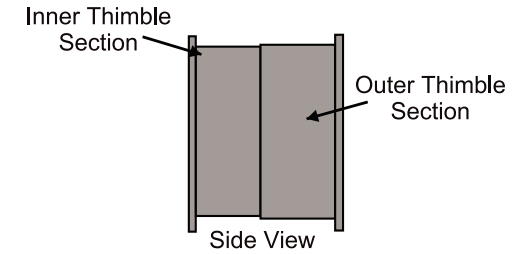
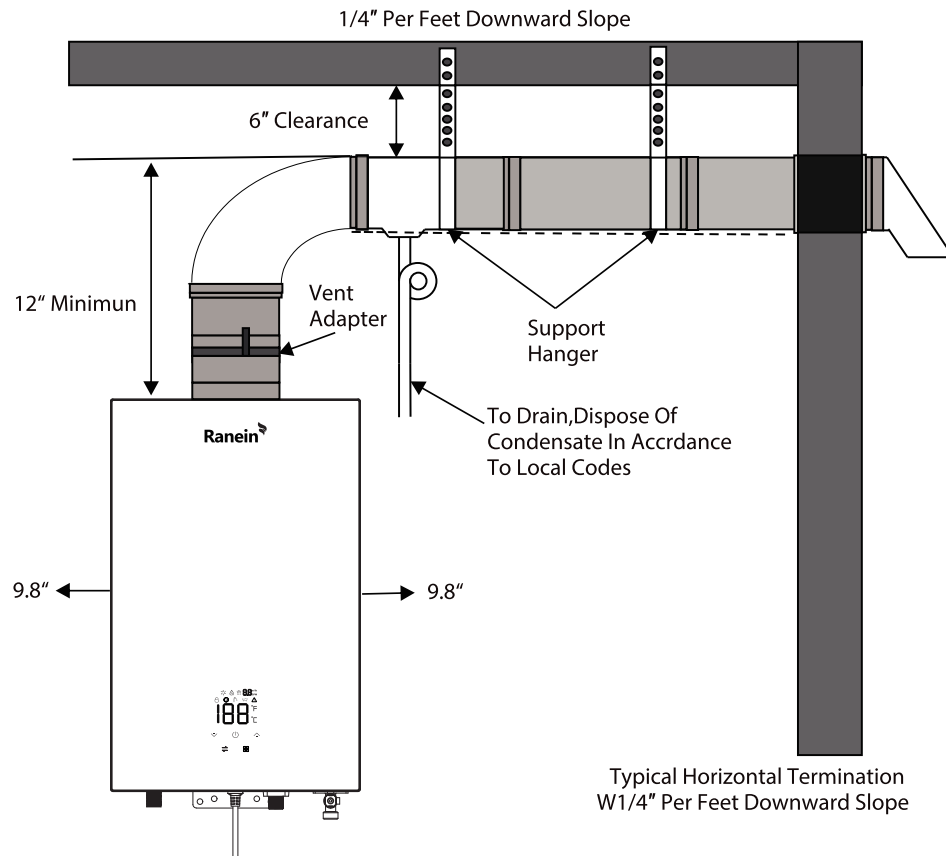

⚠ CAUTION

Follow the vent manufacturer's installation instructions, as designs may vary from one manufacturer to another.

⚠ WARNING

Field wiring connections and electrical grounding must comply with local codes, or in the absence of local codes, with the latest edition of the National Electrical Code (ANSI/NFPA 70) in the U.S., or the Canadian Electrical Code (CSA C22.1 Part 1) in Canada. Only UL-approved Category III vent material is permitted. No other vent material is allowed. The owner must refer to the vent manufacturer's instructions and specifications.

Hardwiring the Electrical Connections

- Wiring should be performed by a qualified electrician in accordance with local codes.
- The water heater requires 120VAC/60Hz power and must be properly grounded.
- DO NOT connect the grounding wire to water pipes, gas pipes, telephone cables, lightning conductor circuits, or the grounding circuit of other equipment that carries a ground-fault interrupter.
- An ON/OFF switch must be installed for the incoming 120VAC power supply.

⚠ CAUTION

Label all wires prior to disconnection when servicing the controls. Wiring errors can cause improper and dangerous operation. Verify correct operation after servicing.

Electrical Connection

Power cord

- The electric power supply requirement for this water heater is 120VAC/60Hz, 2 Amps.
- The water heater comes with a three-pin power supply cord. Use only a power outlet with a grounding terminal.
- It is recommended to install an electric leakage breaker (GFCI).
- Keep any excess of the power supply cord on the outside of the water heater.
- If local codes require hardwiring, refer to the instructions for "Hardwiring the electrical connections".

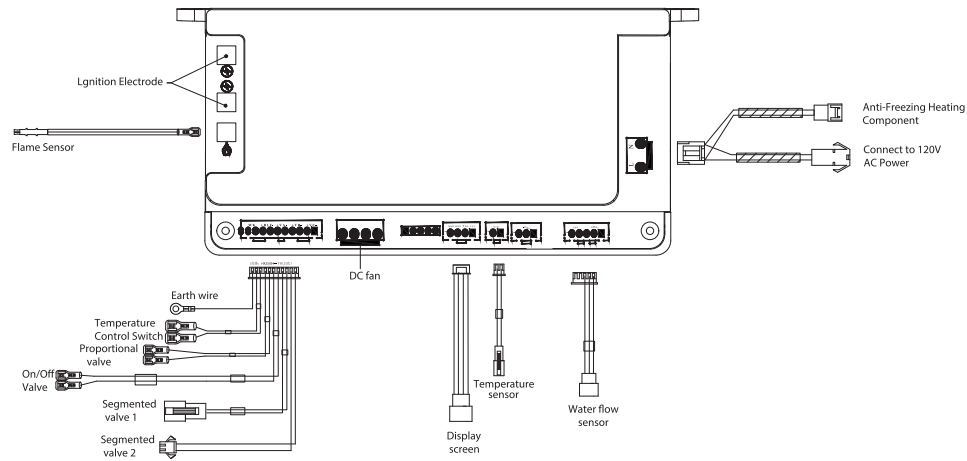

⚠ WARNING

Shock Hazard - Line voltage is present. Before servicing the water heater, turn off the electrical power at the main disconnect or circuit breaker. Failure to do so could result in severe personal injury or death.

Hot and Cold Pipe Insulation Installation

For increased energy efficiency, use pipe insulation. Install the insulation as shown in the illustrations above, ensuring it covers the pipes all the way to the top. Do not cover any drain or pressure valve(s).

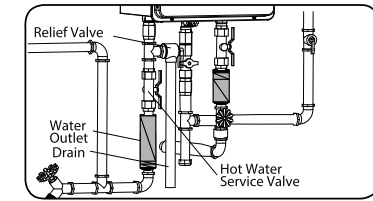
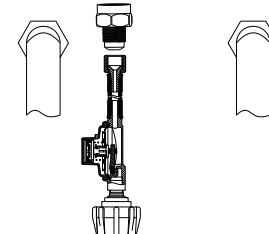
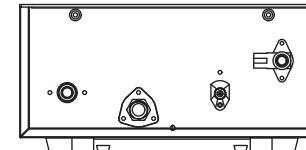
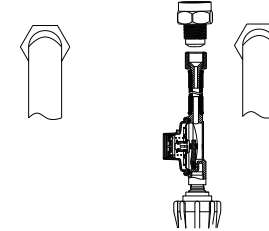
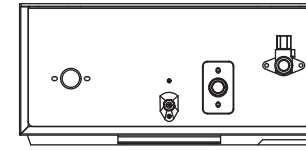

RH8KG-NG / RH8KG-LPG

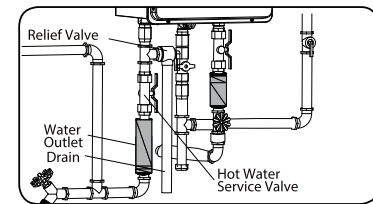

RH11KG-NG / RH11KG-LPG

During Installation of This Water Heater MUST DO

- DO check the inlet gas pressure to ensure it is within the range specified on the rating plate.
- DO provide adequate air for combustion and ventilation, as discussed in the Use and Care Manual and the National Gas Code (CAN/CGA B149 in Canada).
- DO maintain proper clearances to combustibles as specified by the applicable code.
- DO ensure the flue terminal location complies with the guidelines found in the Use and Care Manual and the National Gas Code (CAN/CGA B149 in Canada).

DO NOT

- DO NOT block or restrict the air intake opening located on the back side of the water heater.
- DO NOT remove the front cover unless absolutely necessary. This should only be done

- after inspection by a qualified service technician.
- DO NOT install this product where standing water may occur.

Installation Checklist

A. Water Heater Location

- Installed indoors.
- Close to the area of the most frequently used outlet.
- Protected from freezing temperatures.
- Proper clearance from combustible surfaces observed.
- Sufficient fresh air supply for proper operation of the water heater.
- Air supply free of corrosive elements and flammable vapors.
- Provisions made to protect the area from water damage.
- Sufficient room to service the heater.
- Combustible materials, such as clothing, cleaning materials, rags, etc., clear of the heater and vent piping.
- Water heater is properly attached to the wall.

B. Water Supply

- Water supply has sufficient pressure.
- Air purged from the water heater and piping.
- Water connections are tight and free of leaks.
- Water filter is clean and in place.
- Materials used are as instructed in this manual.
- Water pipes are insulated.

C. Gas Supply

- Gas type matches the rating plate.
- Gas supply pressure is sufficient for the water heater.
- Gas line is equipped with a shut-off valve, union, and sediment trap.
- Approved pipe joint compound used.
- Commercial leak detector or soap and water solution used to check all connections and fittings for possible gas leaks.
- Gas company inspected installation (if required).

D. Relief Valve

- Pressure relief valve is properly installed, and discharge line runs to an open drain.
- Discharge line is protected from freezing.

E. Electrical Wiring

- Voltage matches the rating plate.
- Water heater is properly grounded.
- Wiring meets all local codes.
- GFCI protection where required.

Product features

Automatic Temperature Control: The water temperature can be set within the range of 95°F to 149°F, and it automatically adjusts to ensure convenient and comfortable use.

LED Screen Display: The LED screen displays the water temperature and operating status, providing clear and visual information.

Enhanced Combustion: The product utilizes efficient and high-energy combustion, ensuring high efficiency in water heating.

Safe Exhaust: The smoke is directed outdoors, ensuring safer usage and preventing indoor air pollution.

Fault Code Display and Alarm Function: The product is equipped with a fault code display function, allowing for quick identification of issues and providing alarms for prompt resolution.

Multiple Protection Functions: The water heater includes features such as overheat protection, pressure relief protection, excessive wind pressure protection, exhaust pipe blockage protection, 40-minute timing protection, dry burn protection, freeze protection, and low water pressure startup, ensuring the safe operation of the water heater under normal conditions.

Lighting The Water Heater

Before operating this water heater, be sure to read and follow the instructions on the label pictured below, as well as all other labels on the water heater and the warnings printed in this manual. Failure to do so may result in unsafe operation of the water heater, leading to property damage, personal injury, or death. If you have any difficulty reading or following the instructions in this manual, STOP! Get help from Ranein at www.ranein.net.

Operating The Water Heater

Turning on the water heater

1. Ensure that the gas type you are using matches the type specified on the data plate.
2. Turn on the main gas valve, plug in the power cord (ensure the socket is properly grounded), and press the "ON/OFF" button on the control panel. Set the temperature to 120°F (49°C).
3. Turn on the faucet, and the fan will begin working. You will hear the ignition sound after a few seconds. The burner will ignite, and hot water will begin flowing. If the burner does not ignite successfully, the ignition sound will continue for a few seconds. If the burner still fails to ignite, turn off the faucet and wait for 10-20 seconds, then repeat the above procedures.

For first-time use and/or if the water heater has not been used for a long period, repeating the above procedures may be necessary due to accumulated air inside the gas pipe.

Operating instruction

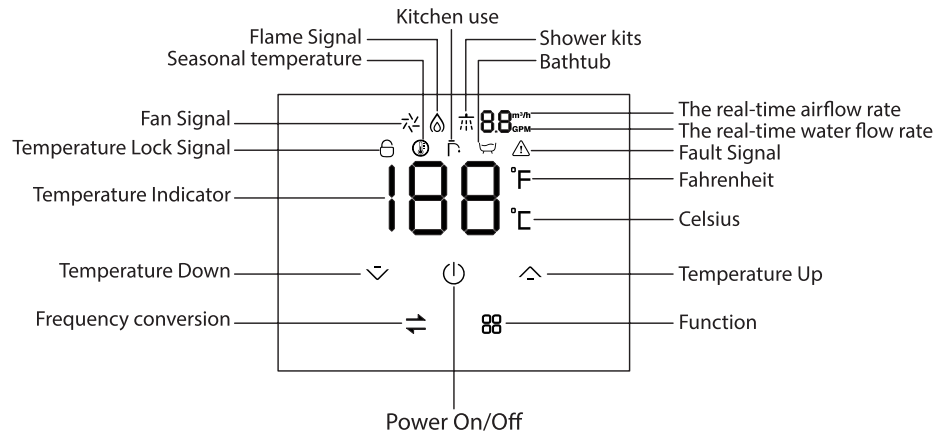

| | | |
|--|----------------------------|---|
| | Fan icon | The icon is always on when the fan is running |
| | Water flow icon | The icon is always on when water flow is detected |
| | Flame icon | Always on when a flame is sensed |
| | Fahrenheit icon | Always on when Fahrenheit is displayed |
| | Celsius icon | Always on when Celsius is displayed |
| | Digital | Display temperature, faultcode, tub fill volume, parameter adjustment value |
| | Real-Time Gas Flow | Display When Querying Real-Time Gas Flow |
| | Real-Time Water Flow Rate | Display When Querying Real-Time Water Flow Rate |
| | Power key | Switch the power button and the rest of the function confirmation keys. |
| | Temperature increase key | Temperature increase key and other function increase keys |
| | Temperature down key | Temperature down key and the rest of the function down key |
| | Temperature conversion key | Short press to convert Fahrenheit, Celsius display |
| | Function key | Short press for function selection |

| | | |
|---|---|---|
| | High-temperature lock function | 1. To prevent high-temperature water scalding, the machine is equipped with a high-temperature lock function, the machine running state when the need to set the water temperature above 122°F(50 °C), you need to long press the temperature key for 3 seconds to unlock, 5s after the completion of the adjustment automatically lock, lock the temperature can not rise after the setting, only down. If you need to continue to rise the temperature, you need to long press 3S to unlock, before you can rise to set. The whole process of setting down is not restricted. 2. No high temperature lock function in standby mode. |
| | Seasonal temperature icon, the icon lights up when the seasonal temperature mode is turned on | Four seasons temperature function: Touch the function button to select the four-season temperature icon to enter the mode, the control system will automatically match the water temperature according to the inlet water temperature, at this time can not manually adjust the temperature, you need to click this button to close the intelligent bath function before you can manually adjust the temperature. Automatic matching temperature is as follows. ① Inlet water temperature <59°F(15°C), match the outlet water temperature to 113°F(45°C); ② Inlet water temperature 60°F(16°C)-70°F(21°C), matching the outlet water temperature of 109°F(43°C); ③ Inlet water temperature 71°F(22°C)-80°F(27°C), matching the outlet water temperature of 104°F(40°C); ④ inlet water temperature ≥ 82°F(28°C), matching the outlet water temperature of 100°F(38°C). |
| | Kitchen icon, the icon lights up when the kitchen mode is turned on | Kitchen function: Touch the function button to select the kitchen icon to enter the mode, select this function after the temperature default is 100°F(38°C), short press the function button again to select the rest of the function or adjust the temperature by ascending and descending keys will exit this function. |
| | Bathtub icon, always on when the bathtub mode is turned on | Bathtub function: Touch the function button to select the bathtub icon to enter the mode, open the bathtub function after the icon "188" and "GPM" flashing display corresponding to the water injection, within 5 seconds, press the ascending and descending temperature keys to adjust the bathtub water injection, water injection adjustment range "13-195GPM", single adjustment to 13GPM change. After 5 seconds of no operation, the display temperature and according to the current setting of water injection began to run, after the completion of the water injection buzzer long warning, after the water off to lift. |
| | Fault icon: Displayed when a malfunction occurs in the entire device. | Troubleshooting: When this icon appears on the device, the issue can be cleared by either turning off the power or closing the inlet and outlet valves. If these methods do not resolve the issue, please contact after-sales service for assistance. |
| / | Automatic timing function | System default continuous operation 40min off heating, turn off the water after the water can be restarted, professionals can enter the program to adjust the timing time or timing off. |

Safety precaution

If there is any difficulty in understanding or following the operating instructions or the Care and Cleaning section, it is recommended that a qualified person or serviceman perform the work.

- DO turn off the manual gas shut-off valve if the water heater has been subjected to overheating, fire, flood, physical damage, or if the gas supply fails to shut off.
- DO NOT turn on the water heater unless both water and gas supplies are fully opened.
- DO NOT turn on the water heater if the cold water supply shut-off valve is closed.
- DO NOT allow combustible materials such as newspapers, rags, or mops to accumulate near the water heater.
- DO NOT store or use gasoline or other flammable vapors and liquids, such as adhesives or paint thinner, in the vicinity of this or any other appliance. If such flammables must be used, open doors and windows for ventilation, and ensure that all gas-burning appliances in the vicinity, including their pilot lights, are shut off to avoid igniting vapors.

⚠ NOTICE

Flammable vapors can be drawn by air currents from surrounding areas to the water heater.

Water Temperature Setting

⚠ DANGER

Water Temperature Setting

Safety and energy conservation are important factors to consider when selecting the water temperature setting. Water temperatures above 125°F (52°C) can cause severe burns or death from scalding. The thermostat is set to its lowest temperature position when shipped from the factory. Be sure to read and follow the warnings outlined on the label pictured below.

⚠ DANGER

There is a risk of scalding if the temperature is set too high. Households with small children, elderly persons, or individuals with disabilities may require a temperature setting of 120°F (49°C) or lower to prevent contact with hot water.

Be sure to read and follow all warnings outlined in this manual and on the label located on the water heater. Mixing valves are available to reduce point-of-use water temperature by blending hot and cold water in branch water lines.

Before manually operating the relief valve, ensure that no one will be exposed to the

danger of hot water released by the valve, as it may be hot enough to cause a scald hazard. The water should be released into a suitable drain to prevent injury or property damage.

For energy-efficient operation, adjust the thermostat to the minimum water temperature setting that meets the consumer's needs.

For more information on proper thermostat adjustment, contact a licensed plumber or the local plumbing authority.

| Time/Temperature Relationship in Scalds | | |
|---|------|--------------------------------|
| Water Temperature | | Time To Produce a Serious Burn |
| 120°F | 49°C | More than 5 minutes |
| 122°F | 50°C | 1 1/2 to 2 minutes |
| 130°F | 54°C | About 30 seconds |
| 135°F | 57°C | About 10 seconds |
| 140°F | 60°C | Less than 5 seconds |
| 145°F | 63°C | Less than 3 seconds |
| 150°F | 66°C | About 1 1/2 seconds |
| 155°F | 68°C | About 1 second |

Table courtesy of the Shriners Burns Institute

The chart shown above can be used as a guide to determine the appropriate water temperature for your home.

Set Temperature Memory

- This water heater is equipped with an electronically controlled thermostat. From the factory, the temperature range is set between 95°F (35°C) and 149°F (65°C).
- To adjust the temperature, press the up button on the control panel to increase the temperature by 1.8°F(1°C), or press the down button to decrease it by 1.8°F(1°C).
- When water is in use or there is water flow, the display will show the actual water temperature. To view the set temperature during operation, press the UP or DOWN button, and the set temperature will flash for 3 seconds.
- The hottest water will be at the hot water faucet closest to the water heater.
- Always supervise young children or individuals who are incapacitated when using hot water.
- If the water heater has been subjected to fire, flood, or physical damage, turn off the manual gas shut-off valve(s). Do not operate the water heater again until it has been inspected by qualified personnel.

⚠ WARNING

If overheating occurs or the gas supply fails to shut off, turn off the manual gas control valve to the appliance immediately.

Care And Cleaning Of The Water Heater

Routine Preventative Maintenance

⚠ DANGER

Before manually operating the relief valve, ensure that no one will be exposed to the danger of hot water released by the valve. The water may be hot enough to cause scalding. The water should be directed into a suitable drain to prevent injury or property damage.

⚠ DANGER

Hotter water increases the potential for hot water scalds.

⚠ DANGER

Failure to perform the recommended routine preventative maintenance can impair the proper operation of this water heater, potentially leading to carbon monoxide hazards, excessive hot water temperatures, and other dangerous conditions.

When properly maintained, your water heater will provide years of dependable, trouble-free service. It is recommended that periodic inspections of the burner, relief valve, water filter, and venting system be conducted by service personnel qualified in gas appliance repair.

It is suggested that the user establish and follow a routine preventive maintenance program.

At least once a year, lift and release the lever handle on the pressure relief valve, located on the hot outlet piping of the water heater, to ensure the valve operates freely. Allow several gallons of water to flush through the discharge line to an open drain.

Rapid closing of faucets or solenoid valves in automatic water-using appliances can cause a banging noise, often referred to as water hammer, in the water pipes. To minimize this issue, strategically placed risers or water hammer arresters in the plumbing system can be used. Additionally, inspect the area around the water heater to ensure a safe operating environment.

Keep the area around the appliance clear and free of combustible materials, gasoline, and other flammable vapors or liquids. Ensure the unit is undamaged. If there is any damage or denting, contact a qualified service technician to verify the unit's proper operation.

Listen for any unusual sounds during the normal operation of the water heater. Inspect all piping for potential gas or water leaks.

The air intake and cold water supply filters should be cleaned monthly.

DO NOT operate the water heater if you suspect something is wrong with the unit.

DO NOT allow children to operate or handle the unit.

⚠ NOTICE

If the pressure relief valve on the hot water heater discharges periodically, this may indicate a problem in the water system. Contact the water supplier or your plumbing contractor for guidance on how to resolve this issue.

DO NOT plug the relief valve outlet.

⚠ NOTICE

After inspection, maintenance, and/or cleaning, ensure proper operation by turning on a hot water faucet.

Maintenance

Before performing any maintenance tasks on this water heater, be sure to turn off the unit and disconnect the power supply.

Vacuum around the water heater regularly to remove dust, dirt, and lint. Clean the water heater and remote control by using a damp, soft cloth with a few drops of mild detergent, gently wiping the surfaces of the unit. Wipe off any remaining moisture with a dry, soft cloth.

To ensure sufficient ventilation and combustion air supply, proper clearances must be maintained. Clean the water filters on a monthly basis.

⚠ DANGER

Shock Hazard: Ensure the electrical power to the water heater is turned off to prevent potential serious injury or damage to components.

⚠ DANGER

Combustible materials, such as clothing, cleaning agents, or flammable liquids, must not be placed against or next to the water heater.

How to Clean the Water Heater

1. Ensure the unit is turned OFF, and the electrical power supply is disconnected.
2. Turn OFF the water supply to the heater.
3. Unscrew the water filter and slide it out.
4. DO NOT tap the filter, as this may deform or damage it.
5. To remove severe dust, use a soft brush and rinse the filter under running water.
6. Reinsert the filter into the water heater and screw it back in securely.
7. Turn the electrical power supply and cold water supply ON to the water heater.
8. Use only mild soapy water for cleaning; other cleaners may damage the surface of the water heater.

- DO NOT remove any labels, including the rating plate, while cleaning or servicing the unit.

▲ NOTICE

DO NOT block or obstruct the air intake opening located at the lower left corner of the water heater. A minimum clearance of 12" is required between this combustion air inlet opening and any obstruction.

Venting System Inspection

The venting system should be inspected annually to ensure all vent sections are secure and airtight.

It is recommended that qualified service personnel familiar with Category III venting inspect the system.

Check the vent connection joint sections with a solution of soapy water to confirm airtightness while the unit is operating. Bubbles around a joint connection indicate a seal leak.

DO NOT operate the unit if the vent system shows signs of leaking exhaust. Ensure that the air intake and vent terminal are not blocked or contain debris.

Vacation and Extended Shutdown

If the water heater is to remain idle for an extended period, turn off the power and water supply to the appliance.

The water heater and piping should be drained if they might be subjected to freezing temperatures.

After a long shut-down period, have the water heater's operation and controls checked by qualified service personnel.

Not Equipped With Anti-freezing Protection

Draining Procedure

When the temperature falls below 32°F (0°C), water in your plumbing system or water heater can freeze and expand, potentially causing damage to the water heater. This damage is not covered under the manufacturer's warranty. If freezing conditions are anticipated, please drain the water heater as follows to help (but not guarantee) prevent freezing:

- Shut off the main gas valve and power supply.
- Shut off the inlet water valve.
- Open all faucets.

- Remove the drain valve and allow the water to drain for 3 minutes or until the unit is empty.
- After ensuring all water has drained, replace the drain valve and close the faucets.

Care And Cleaning Of The Water Heater

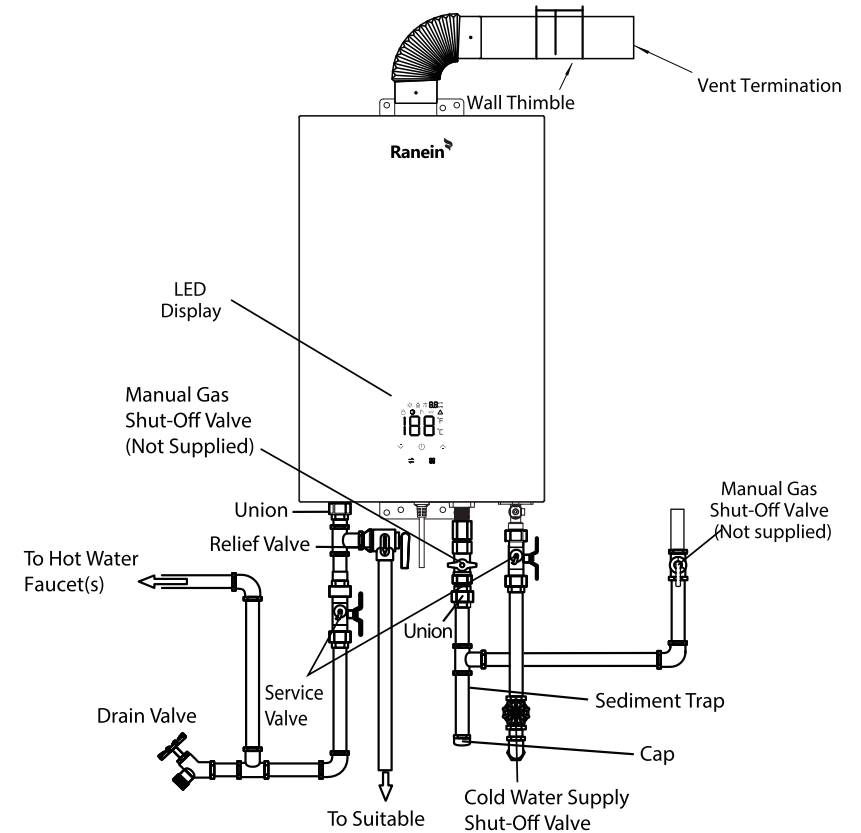

Below are the instructions for draining water from the water heater:

- Close the gas shut-off valve(s).
- Close the water shut-off valve.
- Turn the on/off switch to the OFF position and disconnect the breaker for at least 10 seconds after Step #1.
- Open the drain valve.
- Open all hot water faucets. Before proceeding to the next step, ensure that cold water is coming out of all hot water faucets.

6. To put the water heater back into operation after draining, follow the steps below.
7. Reinstall the water filter and close the hot water outlet drain valve.
8. Open the water shut-off valve and close it again after ensuring that water comes out from the hot water faucets (this step is to remove air from the water lines).
9. Reconnect the breaker and turn the on/off switch to the ON position. Fully open the gas shut-off valve and the water shut-off valve.

⚠ NOTICE

The water heater will not operate properly unless the above procedure is followed correctly.

Replacement Parts And Drawing

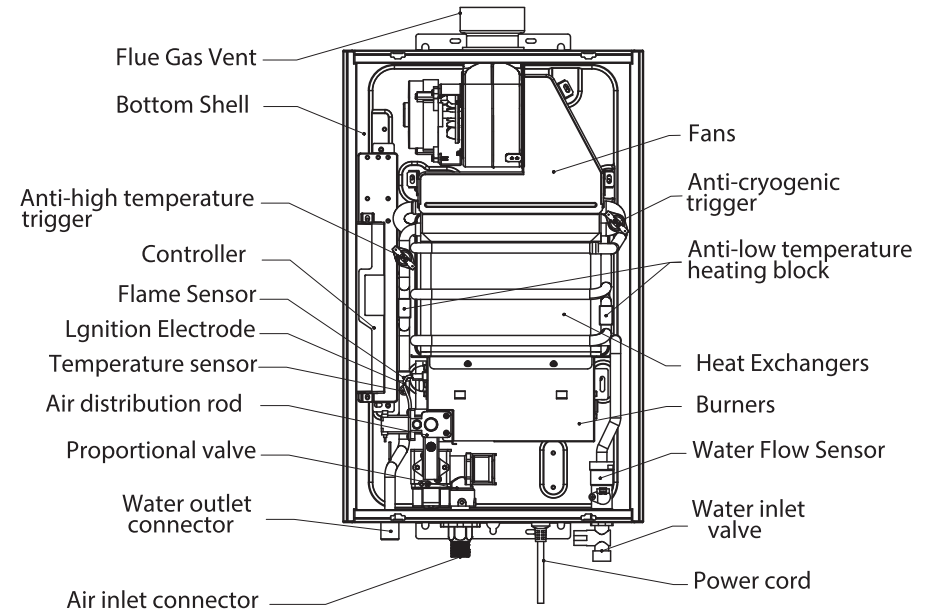
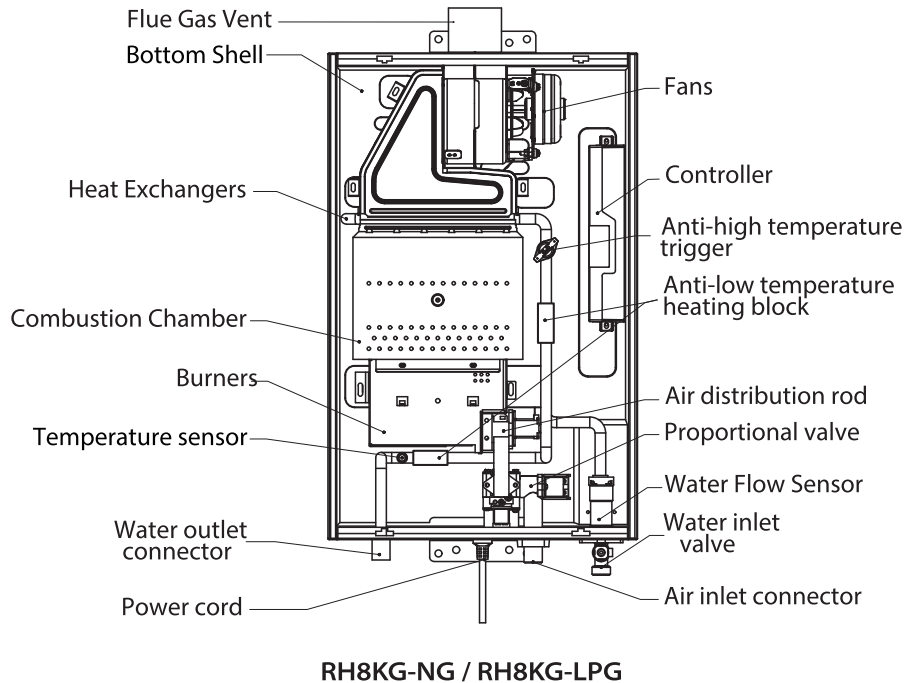

Before You Call for Service Troubleshooting Tips

Save time and money! Review the charts on the following pages first, and you may not need to call for service.

This water heater incorporates a variety of shut-off devices that prevent the operation of the water heater if undesirable combustion conditions occur.

| Phenomenon | Cause | Handling method |
|--|---|---|
| Power indicator light does not light up | Whether there is a power failure | Use after the power comes on |
| | Whether the power plug is loose | Plug in the power supply |
| | Power indicator is bad | Replace the power indicator |
| No hot water comes out even after the hot water tap is opened | Is the gas valve and water inlet valve open | Open the gas valve and air inlet valve |
| | Is there a water cut-off | Use after the water comes in |
| | Is the hot water faucet open too small | Turn up the hot water tap |
| | Whether it is frozen | Drain the freeze before use |
| | Is the gas meter (microcomputer-controlled gas meter) safe to operate | Troubleshoot before use |
| | Is the liquefied gas used up | Replace the gas cylinder |
| Can not produce hot water with high temperature | Is the gas valve fully open, is the air pressure too low, is the water volume adjustment too large | Open the gas valve fully or check the air pressure and turn down the water valve |
| No hot water at lower temperature | Is the gas pressure too high, is the water volume too small | Check the air pressure, turn up the water flow or open the inlet valve and reset the temperature to the right level |
| The hot water faucet is closed too small and becomes cold water | The hot water faucet is closed too small, and becomes cold water when the water flowing out of the hot water faucet is below 3kg/min, it will automatically turn off the fire | Turn on the water volume of the hot water faucet, the temperature of hot water will stabilize |
| Hot water does not flow out immediately after opening the hot water faucet | Since there is a certain distance between the water heater and the hot water faucet, it takes a certain amount of time for the hot water to flow out | Wait a little longer, hot water will flow automatically |
| The hot water that comes out is white and cloudy | This is due to the dissolved air in the water after the heat, the rapid decompression to atmospheric pressure when the phenomenon of small bubbles. It is harmless | Normal phenomenon |
| White smoke is discharged from the exhaust port in the cold season | In winter, the exhaust gas contains a certain amount of water vapor, so you can see white smoke. | Normal phenomenon |
| Hot water becomes cold water after about 40min of continuous use | Timer protection function is in effect, the water heater automatically turns off the fire | Normal phenomenon, restart the machine |
| There is water flowing out of the safety valve | The tap water pressure exceeds the safe water pressure of the machine and the pressure is automatically released, not abnormal | Normal phenomenon, please close the water inlet valve |
| The fan will rotate for a period of time after the machine is turned off | The fan needs to work for a period of time to exhaust the exhaust gas in the machine to reduce the temperature inside the machine | Normal phenomenon |
| The hot water temperature will change when the power is off or unplugged | When the power is off or unplugged, the hot water set temperature will be restored to the factory set temperature when the power is turned on again. | Reset and use again |

Error Code Guide

When an error code is displayed:

1. Close the hot water faucet and turn off the switch on the remote control.
2. Wait for about 5 minutes before turning the switch back on.
3. Open the hot water faucet.

If the error code persists:

1. Close the hot water faucet and turn off the switch on the remote control.
2. Take the proper action shown below and attempt to operate the appliance again.

| Error Code | Fault Names | Possible Causes of Malfunctions | Troubleshooting Steps |
|------------|--------------------------------------|--|--|
| E0 | Water Temperature Sensor Malfunction | Poor contact between the terminal connectors of the temperature sensor and flow sensor and the controller. | Connect the terminal connectors to the controller properly. |
| | | Malfunctioning temperature sensor or flow sensor. | Replace the temperature sensor or flow sensor. |
| E1 | Ignition Failure | Gas valve not opened. | Open the gas valve. |
| | | Low gas pressure. | Adjust the gas pressure to the appropriate range. |
| | | Gas type used is not compatible with the water heater. | Use gas compatible with the water heater. |
| | | Ground wire on the controller not properly connected. | Properly connect the ground wire to the water heater casing. |
| | | Positive and negative terminals of the controller and proportional valve connectors reversed. | Connect the red wire to the "+" and the black wire to the "-" as instructed. |
| E2 | Accidental Flameout | Poor or faulty connection between the flame feedback wire on the controller and the flame feedback pin. | Ensure tight contact between the flame feedback wire on the controller and the flame feedback pin. |
| E3 | Overtemperature Fault | Water temperature detected by the temperature sensor is $\geq 176^{\circ}\text{F}$. | Restart the water heater. |
| | | Malfunctioning temperature sensor. | Replace the temperature sensor. |
| E5 | Fan Failure Fan Speed Exceeds Limit | Malfunctioning fan | Replace the fan |
| | | Poor contact between the fan terminal connectors and the controller. | Connect the terminal connectors to the controller properly |
| | | Air duct is blocked | Eliminate any blockages in the air duct |
| E7 | Solenoid Valve Malfunction | Poor contact between the controller and the solenoid valve. | Properly connect the controller and the solenoid valve. |
| | | Malfunctioning solenoid valve. | Replace the valve body assembly. |
| Eb | Residual Flame Fault | Flame still present after water or power is turned off, and the solenoid valve does not release after closing. | Replace the valve body assembly. |

| | | | |
|----|------------------------------|--|--|
| Ec | Signal Communication Failure | Poor contact of the display screen cable. | Properly connect the display screen cable. |
| | | Damaged controller or display screen. | Replace the controller or display screen. |
| EE | Power Failure Protection | Water supply or power was turned off, and then power was restored without turning off the flame. | Power off and then restart. |
| En | Timer Timeout | Automatic shutdown of the main unit when the set time is reached. | Power off and then restart. |

If the error code still appears:

1. Turn off the hot water faucet and turn off the switch on the remote control.
2. Address the issue indicated by the error code and contact customer service at service@ranein.net for further assistance.

Ranein, Enjoy Life!

Limited Warranty Information

Ranein warrants this product to be free from material defects in materials and workmanship when installed and operated according to Ranein's installation and operating instructions. This Limited Warranty extends to the original purchaser and subsequent owners, but only while the product remains at the site of the original installation. This Limited Warranty terminates if the product is moved or reinstalled at a new location. There are no warranties, express or implied, other than those contained in this Limited Warranty. No agent, employee, or representative of Ranein has the authority to bind Ranein to any representation or warranty concerning the product that is not included in this Limited Warranty.

AS EXPRESSLY SET FORTH HEREIN, THERE ARE NO REPRESENTATIONS OR WARRANTIES, EXPRESS OR IMPLIED, INCLUDING, WITHOUT LIMITATION, WARRANTIES OF MERCHANTABILITY OR FITNESS FOR A PARTICULAR PURPOSE WITH RESPECT TO ANY GOODS SOLD HEREUNDER. BUYER'S EXCLUSIVE REMEDY IS LIMITED TO REPAIR OR REPLACEMENT OF THE GOODS SOLD, AT RANEIN'S DISCRETION. RANEIN SHALL NOT BE LIABLE FOR INCIDENTAL OR CONSEQUENTIAL DAMAGES.

Item Period of Coverage:

Heat Exchanger: 1 year

All other parts: 1 year

Free Accessories (showerhead, hose, regulator, etc.): 30 days

Coverages are void if the unit is used in a hot water circulation loop, in series with a circulation system, or where an on-demand recirculation system is not incorporated. The owner is responsible for all other costs incidental to repair, such as labor, shipping, delivery, and permits. Proof of purchase is required. Products that are repaired will be covered under this Limited Warranty for the remainder of the original purchase term.

This Limited Warranty becomes null and void if any of the following are determined to be a contributing factor to the failure of the product:

1. Abuse, misuse, alteration, neglect, or misapplication.
2. Improper or inadequate maintenance.
3. Inadequate water quality.
4. Installation in a corrosive or otherwise destructive environment.
5. Freeze damage.
6. Scale buildup.
7. Incorrect gas or water pressure.
8. Acts of force majeure.

This product is not to be used as a pool or spa heater.

Within the first 30 days of purchase, Ranein will cover all ground shipping costs for warranty-related issues, excluding AK, HI, Canada, and any location outside of the continental U.S. After the first 30 days of purchase, Ranein will cover all shipping costs to the customer for warranty-related issues, excluding AK, HI, Canada, and any location outside of the continental U.S. After the first 30 days of purchase, the customer is responsible for all shipping costs to Ranein, regardless of the reason or circumstance. The method for warranty-related shipping will be ground equivalent with the provider of Ranein's choosing.

For AK, HI, Canada, and any location outside of the continental U.S., the customer will be responsible for all shipping costs, regardless of reason or circumstance.

All shipments of any type of product coming to Ranein for any reason must have an RGA (Return Goods Authorization) for any repairs to be made. Please contact Ranein to obtain an RGA number prior to shipping anything to Ranein. Failure to do so could result in the loss of the product. Ranein will not be responsible for replacement due to loss or damage if these steps are not properly followed.

⚠ CAUTION

For your safety, DO NOT attempt to repair the gas piping, remote control, burners, vent connectors, or other safety devices. Refer repairs to qualified service personnel.

⚠ CAUTION

Make sure the power to the water heater is turned "OFF" before removing the protective cover FOR ANY REASON.

⚠ CAUTION

Label all wires prior to disconnection when servicing the controls. Wiring errors can cause improper and dangerous operation. VERIFY PROPER OPERATION AFTER SERVICING.