

**gorenje**

EN

GB

IE

**INSTRUCTIONS FOR USE**  
COMBINED MICROWAVE  
OVEN

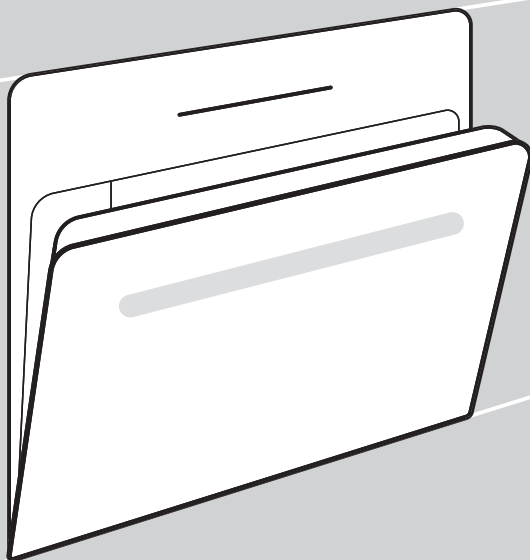

We thank you for your trust and the purchase of our appliance.

This detailed instruction manual is supplied to make the use of this product easier. The instructions should allow you to learn about your new appliance as quickly as possible.

Make sure you have received an undamaged appliance. If you do find transport damage, please contact the seller from which you purchased the appliance, or the regional warehouse from which it was supplied. The telephone number can be found on the invoice or on the delivery note.

Instructions for installation and connection are supplied on a separate sheet.

Carefully read the instructions for use before connecting the appliance. Repair or any warranty claim resulting from incorrect connection or use of the appliance shall not be covered by the warranty.



For more detailed instructions and tips, please visit <http://www.gorenje.com> or scan the QR code on the rating plate.

The following symbols are used throughout the manual and they have the following meanings:

 **INFORMATION!**  
Information, advice, tip, or recommendation

 **WARNING!**  
Warning – general danger

# Contents

<b>1. Safety precautions</b> .....	<b>4</b>
1.1 Safe use of the microwave oven .....	5
<b>2. Other important safety warnings</b> .....	<b>7</b>
<b>3. Appliance description</b> .....	<b>10</b>
3.1 Appliance equipment .....	10
3.2 Control panel .....	12
<b>4. Before first use</b> .....	<b>13</b>
4.1 Switching on for the first time .....	13
<b>5. Microwave function</b> .....	<b>15</b>
<b>6. Using the oven – selecting the baking settings</b> .....	<b>16</b>
6.1 Main menu - Manual .....	17
6.2 Timer - Timer functions .....	20
6.3 Cooking by steps ( + menu) .....	22
6.4 Microwaves .....	23
6.5 Automatic menu .....	24
6.6 Extra .....	24
<b>7. Starting the cooking process</b> .....	<b>26</b>
<b>8. End of cooking by touching</b> .....	<b>26</b>
8.1 Gratin ( + menu) .....	27
8.2 Crispy bottom .....	28
8.3 Favourites - save your own settings .....	29
<b>9. General settings</b> .....	<b>30</b>
9.1 Display lock (+ menu) .....	31
<b>10. ConnectLife</b> .....	<b>31</b>
<b>11. Wi-Fi management</b> .....	<b>32</b>
11.1 Using Wi-Fi .....	32
11.2 Managing the oven remote control .....	33
<b>12. General tips and advice for baking</b> .....	<b>35</b>
12.1 Cooking table .....	36
<b>13. Cleaning and maintenance</b> .....	<b>41</b>
13.1 Cleaning the oven (Steam Clean) .....	42
13.2 Removing and cleaning the wire guides .....	42
13.3 Replacing the bulb .....	43
<b>14. Troubleshooting</b> .....	<b>44</b>
14.1 Troubleshooting table .....	44
14.2 Label – appliance information .....	45
<b>15. Compliance information</b> .....	<b>45</b>
<b>16. Environment protection</b> .....	<b>46</b>
<b>17. Cooking test</b> .....	<b>47</b>

# 1. Safety precautions

## **IMPORTANT SAFETY PRECAUTIONS – CAREFULLY READ THE INSTRUCTIONS AND SAVE THEM FOR FUTURE REFERENCE.**

The appliance may only be connected to the power mains by an authorized service technician or expert. Tampering with the appliance or nonprofessional repair thereof may result in risk of severe injury or damage to the product.

Appliance must be connected to fixed wiring which has incorporated means of disconnection. Fixed wiring must be made in accordance with the wiring rules.

For stationary appliances permanently connected to the fixed wiring, compliance with this requirement is deemed to be met if the disconnection instruction incorporated into the fixed wiring complies with AS/NZS 3000 (Australia only).

The appliance must not be installed behind a decorative door in order to avoid overheating.

**WARNING:** A damaged power cord should only be replaced by the manufacturer or by an authorised repairer or other qualified person, otherwise it may be dangerous.

This appliance can be used by children aged 8 years and above, and by persons with reduced physical, sensory or mental capabilities or lack of experience and knowledge, if they have been given supervision or instruction concerning the use of the appliance in a safe way, and if they understand the hazards involved. Children shall not play with the appliance. Cleaning and user maintenance shall not be done by children without supervision.

**WARNING:** The appliance and its accessible parts become hot during use; avoid contact with heating elements. Children under 8 years of age must be kept away unless continuously supervised.

The appliance is not intended to be controlled by external timers or separate remote control system.

Do not use harsh abrasive cleaners or sharp metal scrapers to clean the oven door glass/ the glass of hinged lids of the hob (as appropriate), since they can scratch the surface, which may result in shattering of the glass.

Do not use steam cleaners or high-pressure cleaners to clean the appliance as this may result in an electric shock.

Never pour water directly on the bottom of the oven cavity. Temperature differences could result in damage to the enamel coating.

### **1.1 Safe use of the microwave oven**

**WARNING:** Due to the extremely high temperatures generated when the appliance is used in combination mode, it is recommended that children only use the oven under adult supervision.

**WARNING:** If the door or door seals are damaged, the oven must not be operated until it has been repaired by a competent person.

**WARNING:** It is extremely hazardous for anyone other than a competent person to carry out any service or repair operation that involves the removal of covers protecting against exposure to microwave energy.

**WARNING:** Liquids and other foods must not be heated in sealed containers since they are liable to explode.

The appliance is intended for use in households and similar environments, such as:

- staff pantries in stores and other working environments;
- family farms;
- accommodation units for guests at hotels, motels, and other accommodation or lodging establishments;
- bed and breakfast establishments.

Only use utensils suitable for use in microwave ovens.

When cooking with microwaves, do not use metal containers for food or beverages.

When heating food in plastic or paper containers, keep an eye on the oven, as such packaging may ignite.

Microwave heating of beverages can result in delayed eruptive boiling. Therefore, take care when handling the container with the heated beverage. To prevent this, place a non-metal object (e.g., a wooden, glass, or plastic spoon) into the container during the heating-up process.

To avoid burns, the contents of baby bottles and baby food jars should be shaken or stirred, and their temperature checked before feeding.

Eggs in their shell should not be heated in microwave ovens since they may explode even after microwave heating has ended.

If you observe smoke, switch off or unplug the appliance and keep the oven door closed to stifle any flames.

The microwave oven is intended for heating food and beverages. Drying food or clothing and heating of hot packs or pads, slippers, sponges, moist cloths etc. may result in injury, ignition, or fire.

The oven should be cleaned regularly, and any food deposits should be removed.

Failure to maintain the oven in a clean condition could lead to deterioration of the surface that could adversely affect the life of the appliance and possibly result in a hazardous situation.

If the appliance is integrated into a kitchen cupboard with a door, the cupboard door should be open while the appliance is in use.

## **2. Other important safety warnings**

The appliance is intended for household use. Do not use it for any other purpose, such as room heating, drying of pets or other animals, paper, fabrics, herbs etc. As this may lead to injury or fire hazard.

The appliance may only be connected to the power mains by an authorized service technician or expert. Tampering with the appliance or nonprofessional repair thereof may result in risk of severe injury or damage to the product.

We recommend that (due to appliance weight) at least two persons carry and install the appliance.

Do not lift the appliance by holding it by the door handle.

Oven door hinges may be damaged when under excessive load. Do not stand or sit on the open oven door, and do not lean against it. Also, do not place any heavy objects onto the oven door.

If the power cords of other appliances located in the vicinity of the oven become entangled in the oven door, they may get damaged, which may cause a short circuit. Therefore, make sure that the power cords of other appliances are at a safe distance.

Make sure the vents are never covered or obstructed in any other way.

Do not line the oven walls with aluminium foil and do not place baking trays or other containers on the bottom of the oven. This would reduce air circulation in the oven, obstruct and slow down the baking process and destroy the enamel coating.

We recommend you avoid opening the oven door during baking, as this increases power consumption and condensate accumulation.

At the end of the baking process, and during baking, be careful when opening the oven door, as there is danger of scalding.

To prevent limescale accumulation, leave the oven door open after baking or using the oven, to allow the oven cavity to cool down to room temperature.

Clean the oven when it has completely cooled down.

Eventual mismatches in colour shades between different appliances or components within a single design line may occur due to various factors, such as different angles under which the appliances are observed, different coloured backgrounds, materials, and room illumination.

Do not use the appliance if it is damaged. Unplug the appliance from the power mains and call an authorized service centre.

The oven can be safely used with or without baking pan guides.

Do not store items in the oven, which could cause danger when the oven is switched on.

**Heed** the minimum distance between the upper edge of the oven and the closest object above it.

The microwave oven is intended for heating food and beverages. Drying food or clothing and heating of hot packs or pads, slippers, sponges, moist cloths etc. may result in injury, ignition, or fire.

**Always use oven mitts** to remove dishes from the oven. Some pots, pans, or trays may absorb the heat from the food and thus become very hot.

Make sure to **only use the cookware** that is suitable for use in a microwave oven. Do not use steel cookware or cookware with golden or silver decorative edges or ornaments.

**Do not leave any accessories or utensils** in your oven when it is off. Do not switch on an empty oven to avoid damaging it.

**Do not use** porcelain, ceramic, or earthenware cookware if such materials are porous or if such cookware is not glazed on the inside. Once heated up, the moisture that would penetrate these pores could cause cracking. Only use cookware intended for use in a microwave oven.

**Always read** and observe the instructions for heating in a microwave oven, specified on the food packaging.

**Be careful** when heating alcohol-containing food, as a combustible mixture of alcohol and air may form inside the oven. Be careful when opening the door.

Use of metal cookware, forks, spoons, knives or staples or fasteners on frozen food packages is not recommended when **cooking or heating with microwaves** or a combination of microwaves and convection baking. After heating, stir the food or leave it to rest until the heat is evenly distributed.

Do not connect the appliance to power supply if an ELCB (earth-leakage circuit breaker) is installed in the power supply circuit.



**WARNING!**

**Carefully read the instructions for use before connecting the appliance. Repair or any warranty claim resulting from incorrect connection or use of the appliance shall not be covered by the warranty.**

### 3. Appliance description



**WARNING!**

Appliance functions and equipment depend on the model.

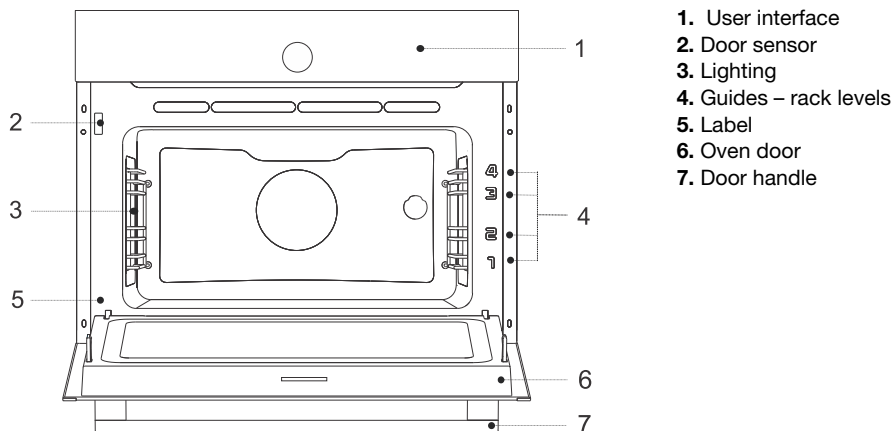

1. User interface
2. Door sensor
3. Lighting
4. Guides – rack levels
5. Label
6. Oven door
7. Door handle

#### 3.1 Appliance equipment

##### Oven door switch

If the oven door is opened during oven operation, the switch turns off the heaters, microwaves, and fan in the oven cavity. When the door is closed, the switch turns the appliance operation back on.

##### Guides

**Wire guides** – always insert the wire rack and baking tray into the guide.

NOTE: Guides – rack levels are counted from the bottom up.

##### Oven equipment and accessories



**WARNING!**

You must not use the wire rack, the shallow or deep baking tray, the silicone cooking mat or any other metal parts in microwave systems.

	<p><b>Wire rack</b>– used for grilling/broiling or as support for a pan, baking tray or baking dish. NOTE: When inserting the wire rack into the guide, always make sure its elevated part is at the back and on the top side. There is a safety latch on the wire rack. Therefore, the wire rack has to be lifted slightly at the front when pulling it out from the oven.</p>
	<p><b>Drip tray</b> – used for flatbreads and small cakes. It can also be used as a collecting tray. NOTE: A shallow baking tray may become deformed when heated in the oven. When it cools down, it returns to its original state. The deformation does not affect its functionality.</p>
	<p><b>Glass baking tray</b> – is used to cook food with all oven systems and microwaves. It can also be used as a serving tray.</p>

Table continued from last page









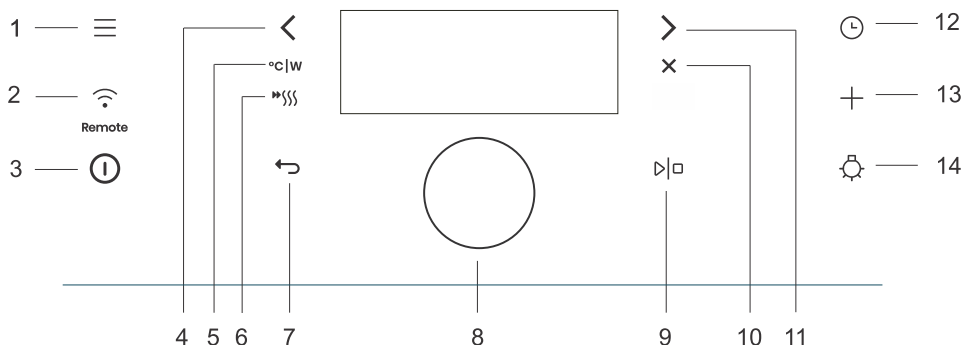







**Deep baking tray** – used for baking vegetables and moist pastries. It can also be used as a drip tray.  
NOTE: Never insert the deep all-purpose (or universal) baking tray into the first guide when baking.





NOTE: Additional equipment can be purchased from an authorised service center.





## 3.2 Control panel



Key		Use
1.		Selection of basic menus
2.		Wi-Fi connectivity settings (Remote)
3.		Switching the oven on and off
4.		Left selector key
5.		Switching between setting temperature or power
6.		Switching the fast preheat on and off
7.		Exit the current state without saving
8.		Button for selecting and confirming settings
9.		Starting and stopping the operation
10.		Cancel the current setting, delete the function
11.		Right selector key
12.		Selection of time functions
13.		Advanced settings
14.		Switching the oven light on and off

NOTE: Only the keys that are enabled in the current menu are illuminated (fully or partially) on the control panel.

Explanation of shortcuts in the manual:			
			
<b>Short press</b> – for basic selections	<b>Long press</b> – 5 sec – for additional settings or fast increase of setting	<b>Rotate</b> – to switch between settings.	<b>Press the button</b> – to confirm your selection.
 <b>INFORMATION!</b> The settings are controlled by the keys and the knob. For better key responsiveness, try touching them with as much of your fingertip as possible. Each time you press a key, this will be acknowledged by an audible signal (when this function is available).			

			
First step	Intermediate step	Passed time (exp. oven is operational)	Optional step

## 4. Before first use

1.	Remove oven utensils and any packaging (cardboard, polystyrene foam, plastic) from the oven.
2.	Wipe the oven accessories and interior with a damp cloth. Do not use abrasive or aggressive cloths or cleaners.
3.	Switch on the oven (see chapter 4.1 <i>Switching on for the first time</i> ).
4.	Preheat the oven with the top and bottom heater system for about one hour  at a temperature of 230 °C (see chapter Manual cooking mode).
NOTE: During heating, the characteristic "new smell" is released, so ventilate the room thoroughly during this time.	

### 4.1 Switching on for the first time

After connecting the appliance to the mains for the first time or after a prolonged power outage, you will need to set the language and time.



### INFORMATION!

If you do not want to set this, press ① . The default settings will be saved. You can change the settings at any time (see chapter9. *General settings*).

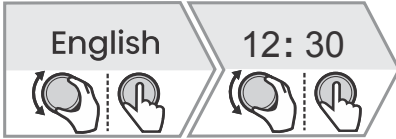

1.	<b>Setting the language:</b> The display shows the default language (English). Rotate the KNOB to change the language. Confirm by pressing the KNOB.
2.	<b>Setting the exact time:</b> You can set the exact time of day by rotating the KNOB. Confirm the selection by pressing the KNOB.
3.	<b>Setting the water hardness:</b> Rotate the KNOB to set the water hardness. Confirm the selection by pressing the KNOB.
All initial settings are set and the appliance is in standby mode.	

# 5. Microwave function

Microwaves are used for **cooking and defrosting of food**. They allow quick and efficient cooking without changing the colour or shape of the food.

Microwaves are a type of electromagnetic radiation. Such radiation is commonly found in our environment in the form of radio-electric waves, light or infrared rays. Microwave frequency is in the 2,450 MHz range.



### WARNING!

**Never use or activate a microwave system if the oven is empty.**

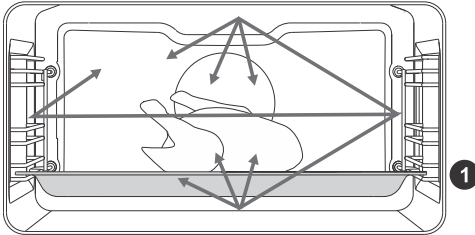

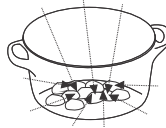
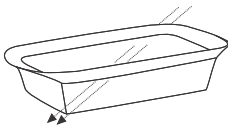
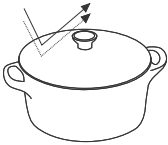

Following are their characteristics:

- microwaves are reflected by metals,
- microwaves travel through other materials,
- microwaves are absorbed by water, fat, and sugar molecules.



When food is exposed to microwaves, the molecules begin to move rapidly, thereby generating heat. The microwaves penetrate approximately 2.5 cm deep into the food. If the food is thicker, the core of the food will be cooked by conduction, as in conventional cooking.



## 6. Using the oven – selecting the baking settings

Home menu	
Switch on the appliance  and select  . By rotating the KNOB you can choose from different menus:	
<b>Manual</b>	Allows you to arbitrarily set the cooking parameters with preset values that can be changed (see chapter 6.1 <i>Main menu - Manual</i> ).
<b>Microwave</b>	Quick access to systems with Microwaves. They are used for quick reheating, defrosting and cooking of food (see chapter 6.4 <i>Microwaves</i> ).
<b>My modes</b>	Allows a large selection of preset programmes depending on the selected dish (see chapter 6.5 <i>Automatic menu</i> ).
<b>Favourites</b>	This mode allows you to select your own programmes that you have previously saved (see chapter 8.3 <i>Favourites - save your own settings</i> ).
<b>Extra</b>	Selection of additional programmes (see chapter 6.6 <i>Extra</i> ).
<b>Cleaning</b>	Oven cleaning programmes.
<b>Settings</b>	General oven settings (see chapter 9. <i>General settings</i> ).

+ menu - additional settings	
The function provides additional setting options. Menu content varies depending on the control options available at that time. To select additional settings, touch  .	
<b>Step bake</b>	Three-step cooking setting with different parameters (see chapter 6.3 <i>Cooking by steps (+ menu)</i> ). The function can be selected after setting the cooking time.
<b>Information</b>	Detailed information on the programmes and function of the oven systems.
<b>Gratin</b>	It is used for dishes to which you add dressing/topping or you want to additionally bake its surface at the end. The function can be selected after 10 minutes of cooking or at the end of cooking (see chapter 7. <i>Starting the cooking process</i> ).
<b>Favourites</b>	Saving selected custom settings (see chapter 8.3 <i>Favourites - save your own settings</i> ).
<b>Display lock</b>	Activating / deactivating the safety key lock to protect the oven from accidental use (see chapter 9.1 <i>Display lock (+ menu)</i> ).

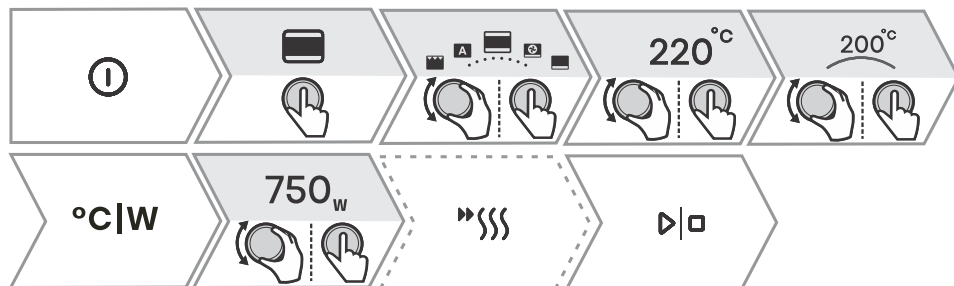
## 6.1 Main menu - Manual



1.	Switch on the appliance  .
2.	You can select the cooking system by turning the KNOB (see table Selection of cooking systems). Confirm the selection by pressing the KNOB.
3.	Rotate the KNOB to set the temperature to confirm the selection.
4.	Use quick preheating to bring the oven to the desired temperature as quickly as possible. By pressing  the symbol will light up fully. When the set temperature is reached, an acoustic signal sounds. The display will show <b>Insert the dish</b> . Open the door and insert the dish. The programme automatically resumes cooking with the selected settings.
5.	Additionally, you can set: <ul style="list-style-type: none"> <li>- Timer (see chapter 6.2 <i>Timer - Timer functions</i>)</li> <li>- Cooking by steps (see chapter 6.3 <i>Cooking by steps (+ menu)</i>)</li> </ul>
6.	To start cooking, touch  .

### Choosing the baking system





Symbol	Use
	<b>Bottom + Top heater</b> Use this system for conventional cooking on a single rack, making soufflés, and cooking at low temperatures (slow cooking).
	<b>Hot air</b> Hot air allows for better air circulation around the dish. In this way, it dries its surface more and creates a thicker crust. For roasting meat, baking cakes, cooking vegetables and for drying food at one or more levels at the same time.
	<b>Hot air + Bottom heater</b> Perfect for making pizza and pastries with a higher water content. For cooking on one level when you want your dishes cooked and crisp as quickly as possible.
	<b>Bottom + Top heater + Fan</b> For even cooking of dishes on one level and making souffles.
	<b>Large grill</b> For cooking large quantities of flat foods, such as toasted bread, canapees, grill sausages, steaks, fish, skewers, as well as for gratinating and achieving a nice crispy crust. The heaters mounted on the top of the oven cavity heat the entire surface evenly. <b>Low level</b> - suitable for cooking fish fillets, whole fish, frying cheese.

Table continued from last page













Symbol	Use
	<p><b>Medium level</b> - suitable for cooking small pieces of meat, fish cutlets, vegetables, canapees, skewers.</p> <p><b>High level</b> - suitable for cooking steaks, burgers, grill sausages, toast and cooking au gratin.</p>
	<p><b>Large grill + Fan</b> For roasting poultry and grilling large pieces of meat.</p>
	<p><b>Hot air + Top heater</b> This cooking method gives the food a crispy crust, without added fat. It is a healthy version of "fast food" with a lower calorie content. Suitable for small cuts of meat, fish, vegetables and pre-cooked frozen products (fries, chicken medallions).</p>
	<p><b>More systems</b> Confirm your selection with <b>OK</b> . Additional systems will be displayed.</p>
	<p><b>Hot air + Microwave</b> For faster cooking and reheating of food while browning the surface. It is used for all types of meat, stews, vegetables and au gratin dishes (dishes that require a longer cooking time).</p>
	<p><b>Large grill + Fan + Microwave</b> For faster grilling of poultry, fish and larger pieces of meat. Microwaves act as a supporting function of the system and speed up food preparation time.</p>
	<p><b>Microwave</b> They are used to quickly reheat, defrost and cook food.</p>
	<p><b>Large grill + Bottom heater</b> For faster cooking of dishes on one level and for a crispy pastry crust.</p>
	<p><b>Bottom heater + Grill</b> For gentle and controlled slow cooking of delicate food (soft cuts of meat) and baking pastry with a crunchy bottom.</p>
	<p><b>Bottom heater + Grill + Fan</b> For optimal preparation of yeast-leavened bakery products and all types of bread and for preservation.</p>
	<p><b>Large grill + Bottom heater + Hot air</b> For dishes where even crispiness from all sides is desirable. The function is also suitable as a first step of multi-step roasting of meat, as it allows for quick searing of the surface in the initial phase and slow roasting in the second phase. The meat will be juicy and the crust nicely browned.</p>
	<p><b>Hot Air + Grill</b> Hot air allows for better air circulation around the dish. This will dry out the surface more. In combination with the grill heater this will also result in a more intensive colour. For faster cooking of meat and vegetables.</p>
	<p><b>ECO Hot air<sup>1)</sup></b> For gentle, slow and even cooking of meat, fish and pastries on one level. This way of cooking retains a higher proportion of water in the meat, which leaves it juicier and softer, while the pastry becomes evenly browned/baked. The used temperature range is between 140 °C and 220 °C. It is the most energy-saving program.</p>

Table continued from last page



Symbol	Use
	<b>Auto</b> Shortcut to the Auto menu (see chapter Auto menu)

1) This function is used to determine the energy efficiency class according to EN 60350-1.

### Microwave power level

Power	Use
1000 W	Quickly reheating beverages, water and dishes containing a large volume of liquid.
750 W	Cooking fresh or frozen vegetables.
600 W	Melting chocolate. Cooking meat and seafood. Cooking side dishes.
360 W	Reheating and cooking of delicate egg-based dishes.
180 W	Defrosting other food, softening butter, softening ice cream.
90 W	Defrosting cream pastry, fruit, vegetables, and ground/minced meat.

## 6.2 Timer - Timer functions

To select the timer functions, touch  . By pressing  or  you can select the time function you want to set.

The time function can be set before and during cooking.



### INFORMATION!

The clock must be set to day time.





### INFORMATION!

You can reset the selected time function by touching **0:00** .

Description / time function	Use
<b>Duration</b>	In this mode, you can specify the duration of operation for the oven.
<b>Egg timer</b>	The independent alarm operates independently of the oven operation. After the set time has expired, the appliance does not turn on or off automatically.
<b>End baking at</b>	Use this mode when you want the food in the oven to start cooking with a time delay. Enter the duration and desired end time of cooking. The appliance starts automatically and ends its operation at the desired time.

### Setting duration



1. Rotate the KNOB to set the desired cooking time. Confirm the selection by pressing the KNOB. The selected oven operating time will appear on the display unit.
2. To start cooking, touch   .

### Setting the timer





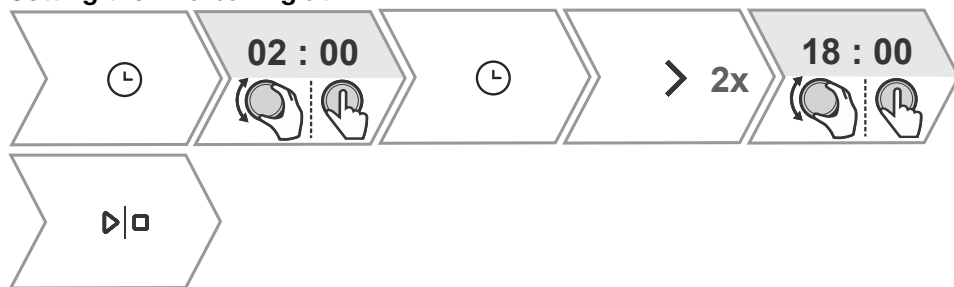

1. Rotate the KNOB to set the timer duration. Confirm the selection by pressing the KNOB.
- The maximum possible setting is 24 hours.  
NOTE: If the appliance is switched off, the timer is still active.

## Setting the End baking at



### **INFORMATION!**

Delayed start is not possible if you select a system with microwaves or when you select the preheat function.

1.	First set the cooking time. Rotate the KNOB to set the desired cooking time. Confirm the selection by pressing the KNOB. The selected oven operating time will appear on the display unit. <i>Example: cooking time is 2 hours</i>
2.	Delayed cooking switch-off is selected by pressing  and then double-clicking on  . Rotate the KNOB to set the time at which you want the dish to be ready. Confirm the selection by pressing the KNOB. The desired end time is shown on the display. <i>Example: cooking ends at 18:00</i> 
3.	To start cooking, touch   . The oven switches to partial standby mode while waiting for switch-on. The selected settings are automatically switched on and off at the selected time. <i>Example: cooking starts at 16:00, cooking ends at 18:00</i>

After the set time has expired, the oven stops working automatically. A short beep will be emitted.

### **WARNING!**

**This function is not suitable for food that requires quick preheating. Perishable food should not be kept in the oven for a long time. Before using this mode, check whether the clock on the appliance is accurately set.**

## 6.3 Cooking by steps ( + menu)

This function allows you to set the cooking in three steps (combine three consecutive cooking steps in one cooking process).



### INFORMATION!

The function can be set in the Main Menu - manual cooking mode (see chapter 6.1 Main menu - Manual).

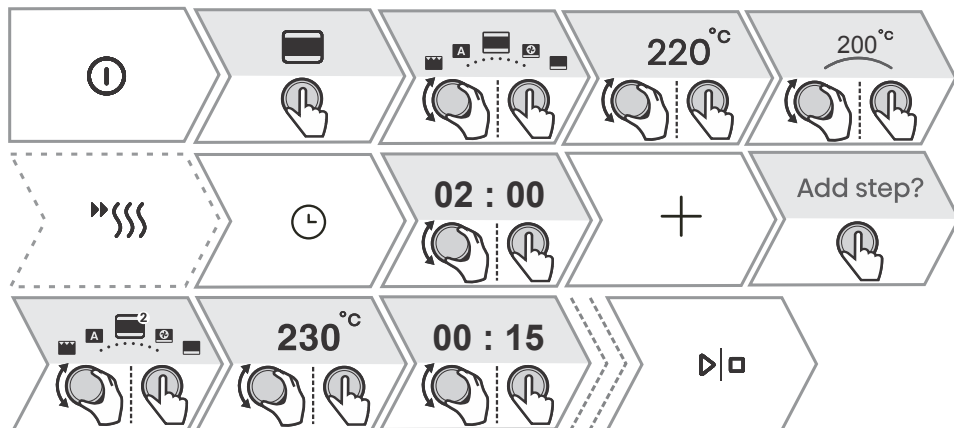

1.	Switch on the appliance  .
2.	<b>Step 1</b> By turning the KNOB, you can select the cooking system, temperature and cooking duration as the first step. Confirm the selection by pressing the KNOB. You can also choose quick preheating.
3.	Select additional settings. Touch  . The display will show <b>Add step</b> . Confirm by pressing the KNOB.
4.	<b>Step 2</b> Select the settings for the second cooking step (see setting under point 2). Confirm the selection by pressing the KNOB. NOTE: Do the same for <b>Step 3</b> .
5.	You can also change all three steps before starting cooking. By pressing  or  you can select the step you want to change.
6.	To start cooking, touch  . The oven first starts working with the settings for the first step.
NOTE: You can remove an individual step by touching  .	

## 6.4 Microwaves

Used to quickly reheat, defrost and cook food.

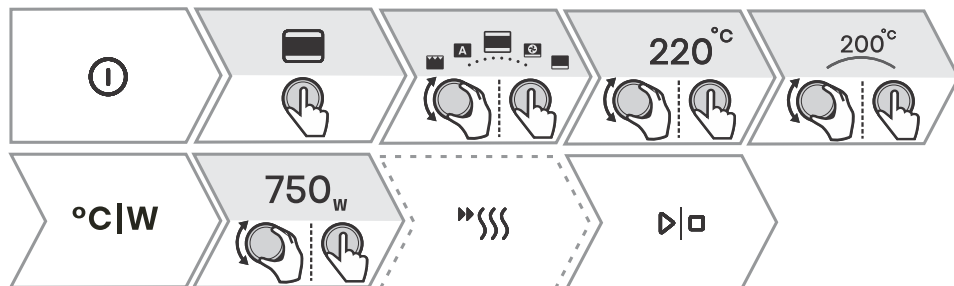

1.	Switch on the appliance and select  . By touching < or > select <b>Microwave</b> . Confirm by pressing the KNOB to enter the submenu.
2.	Rotate the KNOB to select the system: (see table Choosing the cooking system and Microwave operation power) Hot air + Microwaves Large grill + Fan + Microwaves Microwaves
3.	Rotate the KNOB to set the temperature and confirm the selection. If you selected the combined microwave system, touch °C W to set the operating power ( W ) by rotating the KNOB.
4.	Use quick preheating to bring the oven to the desired temperature as quickly as possible. By pressing  the symbol will light up fully. When the set temperature is reached, an acoustic signal sounds. The display will show <b>Insert the dish</b> . Open the door and insert the dish. The programme automatically resumes cooking with the selected settings.
5.	Additionally, you can set: - Timer - you can set the duration of operation and the alert (see chapter 6.2 <i>Timer - Timer functions</i> ) - Cooking by steps (see chapter 6.3 <i>Cooking by steps ( + menu)</i> ) - Au gratin function (see chapter 8.1 <i>Gratin ( + menu)</i> )
6.	To start cooking, touch  .

## 6.5 Automatic menu

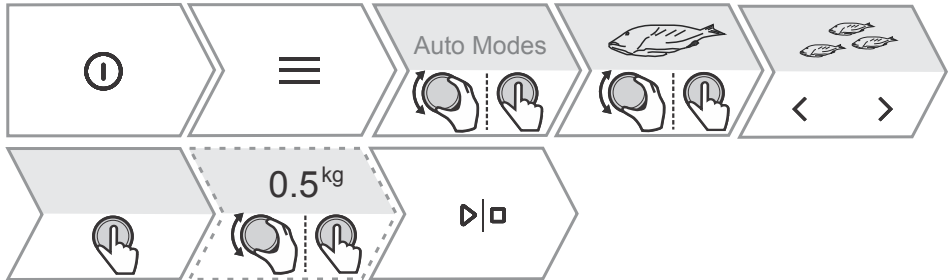

The programme offers you a large selection of preset recipes that were approved by chefs and nutritionists.



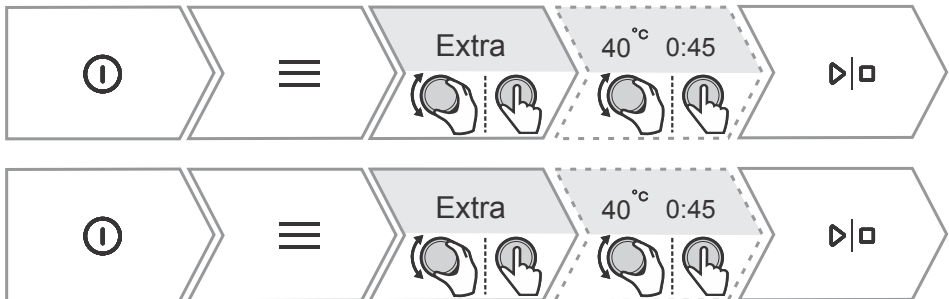

- |    |   |
|----|---|
| 1. | Switch on the appliance and select  . Rotate the KNOB to select <b>Auto</b> . Confirm by pressing the KNOB to enter the submenu.  |
| 2. | Rotate the KNOB to select the desired category and confirm the selection by pressing the KNOB. By pressing  or  select a subcategory, then rotate the KNOB to specify the type of dish and confirm the selection by pressing the KNOB again.<br>The recipes have a predetermined system, temperature and cooking time.<br>NOTE: For some dishes, you can change the weight and degree of cooking. |
| 3. | To start cooking, touch  .  |
| 4. | Some dishes also include the quick preheating function. When the set temperature is reached, an acoustic signal will sound. The display will show <b>Insert the dish</b> . Open the door and insert the dish. The programme automatically resumes cooking with the selected settings.   |
- NOTE: By touching you can see a detailed description of the current selection.

## 6.6 Extra



1.	Switch on the appliance and select  . By pressing the KNOB, select <b>Extra</b> . By pressing the KNOB again, confirm the selection to enter the submenu.
2.	Rotate the KNOB to select a function (see table below). Confirm by pressing the KNOB. Preset values are displayed. Some functions allow you to set the temperature and cooking duration.
3.	To start cooking, touch   .

Programme	Use
<b>Air Fry</b>	Frying food with hot air, without added fat. Faster and healthier version of "fast food". This cooking method gives the food a crispy crust, without added fat. It is a healthy version of "fast food" with a lower calorie content.
<b>Proofing</b>	The dough will rise faster and more evenly without drying out the surface. While the dough is rising, do not open the door.
<b>Dehydrate</b>	With the help of air, you reduce the amount of moisture in the food and thus prolong its durability.
<b>Defrost</b>	Used for the slow defrosting of frozen food (cakes, pastries, bread and fruit). Halfway through defrosting, turn the food over and separate the pieces if they are stuck to each other.
<b>Reheat</b>	This mode allows you to gently reheat ready-made dishes. Do not open the door unnecessarily during operation.
<b>Keep warm</b>	It is used to keep already prepared dishes warm. Do not open the door during operation.
<b>Plate warming</b>	Useful if you want to preheat the plates or cups so that the food stays warm for a long time. You can set the temperature range.
<b>Preserving</b>	The process by which we prolong the durability of the food. Use jars with a rubber sealing ring and lid. Do not use jars with threaded or metal caps or metal tins. Pour 1 litre of hot water (approximately 70 °C) into the deep tray and place 6 identical jars into the tray. Place the baking tray in the oven on the second guide.
<b>Sterilise bottles</b>	Suitable for sterilisation of all types of bottles. Sterilisation is a process that destroys all types of microorganisms.
<b>Sabbath</b>	The Sabbath function allows the food in the oven to stay warm without having to turn the oven on and off. Set the duration of operation (between 24 and 72 hours) and temperature. By pressing   , the countdown begins. All sounds and operations are switched off except for the key  . NOTE: In case of a power outage, Sabbath mode will be deactivated and the oven will return to its initial state.

## 7. Starting the cooking process

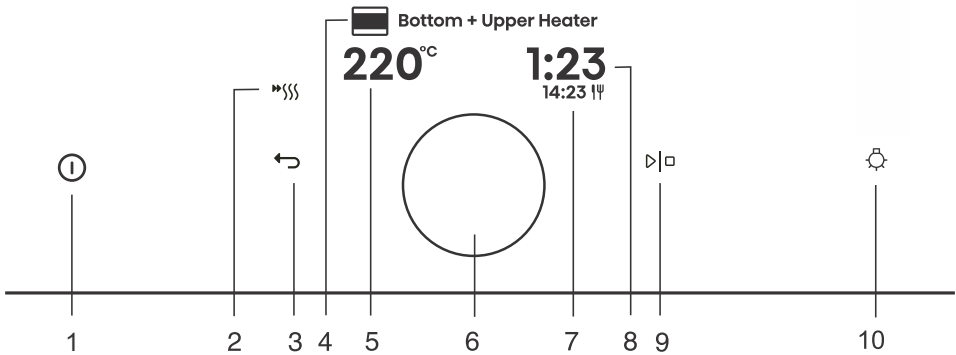

Key		Use
1.		Switching the oven on and off
2.		Switching the fast preheat on and off
3.		Exit the current state without saving
4.		Selected cooking system
5.	<b>220°C</b>	Selecting the temperature
6.		Button for selecting and confirming settings
7.	14:23	End time
8.	<b>1:23</b>	Elapsed cooking time
9.		Starting and stopping the operation
10.		Switching the oven light on and off

NOTE: Only the keys that are enabled in the current menu are illuminated (fully or partially) on the control panel.



### INFORMATION!

During the cooking process, you can change the system, temperature and timer functions.

## 8. End of cooking by touching

After cooking is completed, the display shows **Baking finished**.

You can also stop the operation by touching **Baking finished**.



By turning the KNOB, you can select a new setting. Confirm by pressing the KNOB. Menu content varies depending on the control options available at that time.	
<b>Baking finished</b>	Select End to finish cooking. The main menu appears on the display.
<b>Add extra time</b>	By selecting this, you extend the cooking with the same system and temperature settings. NOTE: If you had a cooking duration set, the time is counted forward from where it was stopped.
<b>Gratin</b>	Select to cook the top of the dish even more (see chapter 8.1 <i>Gratin (+ menu)</i> ).
<b>Crispy bottom</b>	Select to further brown the underside of the dish (see chapter 8.2 <i>Crispy bottom</i> ).
<b>Add to favorite?</b>	This mode allows you to save the selected settings to your favourites and use them again later (8.3 <i>Favourites - save your own settings</i> ).

### INFORMATION!

After the operation is completed, all timer settings are also stopped and deleted, except for the egg timer. Time of day (clock) will be displayed. The cooling fan will continue to operate for a while.

After the use of the oven, some water may be left in the condensate channel (underneath the door). Wipe the channel with a sponge or a cloth.

## 8.1 Gratin (+ menu)

This function is used in the last phase of cooking, when we add dressing/topping to the dish or we want to crispen its surface. When using the gratin function, a crispy golden yellow crust is formed on the dish, which protects it from drying, and at the same time gives the dish a nicer appearance and better taste.



1.	Press <b>+</b> and rotate the KNOB to select <b>Au gratin</b> . The function is available after 10 minutes of operation.
2.	The display shows the preset system (large grill) and the temperature 250 °C. Set the operating time (max 10 min) and confirm the selection by touching <b>▷ ◻</b> .
3.	The function can also be switched off during operation. Switch off the cooking by touching <b>▷ ◻</b> .

Table continued from last page



**WARNING!**

Control the cooking. When using the au gratin function, the oven reaches high temperatures.

The au gratin function works for a maximum of 10 minutes, then the oven switches off automatically.

## 8.2 Crispy bottom

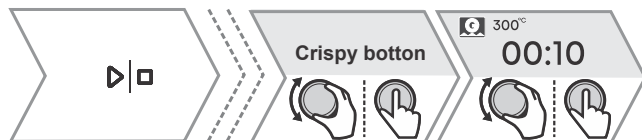







This function is available only at the end of cooking and can be activated for 10 min.

- |    |  |
|----|--|
| 1. | In the final menu, rotate the KNOB to select <b>Crispy bottom</b> . Confirm your selection by touching ▷ ◻ . |
| 2. | Switch off the cooking by touching ▷ ◻ .   |

## 8.3 Favourites - save your own settings

Add to favourites is a feature that allows you to save your favourite and most frequently used settings and use them again in the future. Up to 12 recipes can be stored.



1.	<p><b>Saving recipes in settings.</b> Press  and rotate the KNOB to select <b>Add to favorite?</b>. Confirm by pressing the KNOB.</p>
2.	<p><b>Saving the setting after cooking is completed.</b> In the final menu, rotate the KNOB to select <b>Add to favorite?</b>. Confirm by pressing the KNOB.</p>
<p>You can also change the name of a saved setting. Rotate the KNOB to select the letter and confirm it by pressing the KNOB. If necessary, delete the character with . Confirm with  to save your favourite recipe.</p>	
3.	<p><b>Displaying already saved recipes.</b> Press . Rotate the KNOB to select <b>My modes</b>. Confirm by pressing the KNOB to enter the submenu. Saved recipes are displayed. NOTE: You can also change the preset values for already saved recipes and save them under a new name after cooking.</p>
4.	<p><b>Deleting already saved recipes</b> Switch on the appliance and select . Rotate the KNOB to select <b>My modes</b>. Confirm by pressing the KNOB to display already saved recipes. Select a recipe and delete it by pressing .</p>

## 9. General settings



### WARNING!

After a power outage or after the appliance is switched off, additional function settings will remain stored for no more than a few minutes. Then, all settings, except for the acoustic signal volume and display dimmer will be reset to factory defaults.











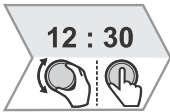
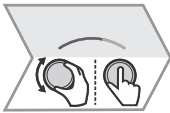
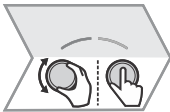

<p>Press  . Rotate the KNOB to select <b>Settings</b>. Confirm by pressing the KNOB to enter the submenu.</p> <p>Rotate the KNOB to edit the individual settings. Confirm the selection by pressing the KNOB.</p>	
1.	 <p><b>Clock</b> Set the hours and minutes. You can select the 12h or 24h display by touching  .</p>
2.	 <p><b>Volume</b> You can choose between four levels of volume (no sound, low, medium, high).</p>
3.	 <p><b>Touch Sound</b> Enable or disable key sound.</p>
4.	 <p><b>Night mode</b> This feature automatically reduces display brightness between 19:00 and 7:00 and turns off the clock display as well as the acoustic signals. To activate night mode, specify the start time and end time of operation. Turn off the night mode by pressing  .</p>
5.	 <p><b>Display</b> The function allows you to turn the daytime display on or off. It is deactivated by default (OFF). If the function is turned on (ON), electricity consumption may increase.</p>
6.	 <p><b>Fast preheat settings</b> The function activates automatic preheating to cooking systems that allow it. Turn it on (ON) or off (OFF).</p>
7.	 <p><b>Heating systems</b> The function activates the display of all cooking systems on the display unit. Turn it on (ON) or off (OFF).</p>

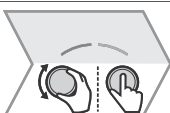
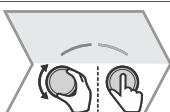
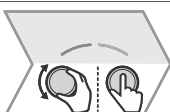
Table continued from last page

8.		<p><b>Resets - Factory reset</b> This function resets the appliance to factory settings. The display will show <b>Reset</b>, which is confirmed by long pressing  .</p>
9.		<p><b>Language</b> The display shows the default language (English). If the language in which the texts are displayed on the display does not suit you, choose another one.</p>
<p>To exit the general settings menu, touch  or .</p>		

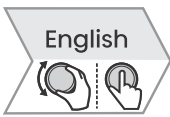
## 9.1 Display lock (+ menu)

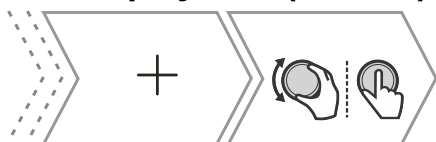

1.	<p>Press  and rotate the KNOB to select <b>Display locked</b>. Confirm the selection by pressing the KNOB. The screen is now locked. To unlock the screen, touch .</p>
----	--

- If the lock is activated with no timer function engaged (only clock is displayed), then the oven will not operate.
- If the lock is activated after a timer function has been set, then the oven will operate normally; however, it will not be possible to change the settings.
- When the keys are locked, you cannot change the cooking systems or additional functions. You can only turn off the cooking.
- The keys remain locked even after the oven is switched off. To select a new system, you must deactivate the lock.

## 10. ConnectLife

Connecting the appliance to the ConnectLife application

**ConnectLife** is a smart home platform that connects people, devices and services. The **ConnectLife** application includes advanced digital services and carefree solutions that allow users to monitor and control appliances, receive notifications from a smartphone, and update software (supported features may vary depending on your appliance and the region/country in which you are located).

To connect your smart device, you need a home Wi-Fi network (only 2.4 GHz networks are supported) and a smartphone equipped with the application **ConnectLife**.



To download the **ConnectLife**, application, scan the QR code or search for **ConnectLife** in your favourite app store.

1. Install the **ConnectLife** application and create an account.
2. In the **ConnectLife** application, go to the "Add device" menu and select the appropriate type of device. Then scan the QR code (it can be found on the nameplate of the appliance; you can also enter the AUID/MV number manually).
3. The application then guides you through the entire process of connecting the appliance to your smartphone.
4. After a successful connection, the appliance can be operated remotely via the mobile application.

## 11. Wi-Fi management

### INFORMATION!



If this setting is not available, then your oven is not fitted with a Wi-Fi module and does not support internet connectivity.

When the Wi-Fi module is enabled and connections are successfully set up and synchronized, then the oven can be controlled and operated via a mobile device and the **ConnectLife** app.



The Wi-Fi connection works in the same frequency range as some other devices (e.g. microwave ovens and remote-controlled toys). Consequently, temporary or permanent disruption of the connection is possible. In such cases, the availability of the offered functions cannot be guaranteed.

Ensuring the quality of the functions offered depends heavily on the signal strength. If the router is far away from the appliance, there may be problems with the reliability of the connection.

### 11.1 Using Wi-Fi

Switch on the appliance , then press  to activate the Wi-Fi function settings.

To enter different Wi-Fi module settings, press .

If you touched  inadvertently, the setting can be cancelled by repeatedly long tapping (for 18 seconds) .











1.		<p><b>Switching on the Wi-Fi module:</b> After long-pressing (up to 3 seconds) , the display will show <b>Wifi On</b> to indicate that the module is switched on. The symbol <b>Wifi On</b> will start blinking.</p>
2.		<p><b>Connecting the appliance:</b> After long-pressing (between 3 to 6 seconds) , the display will show <b>Connection setup</b>. NOTE: For further settings, follow the instructions in the ConnectLife app..</p>

Table continued from last page

3.		<p><b>Connecting additional users:</b> After long-pressing (between 6 to 9 seconds) , the display will show <b>Pairing</b>. Use this setting to connect additional users to the appliance using the ConnectLife app.. NOTE: For further settings, follow the instructions in the ConnectLife app..</p>
4.		<p><b>Removing all connected users:</b> After long-pressing (between 9 and 12 seconds) , the display will show <b>Unpair all</b>. Use this setting to remove all connected users from the ConnectLife app..</p>
5.		<p><b>Switching off the Wi-Fi module:</b> Switch off the Wi-Fi connection by long tapping (between 15 and 18 seconds) . The display will show <b>Wifi Off</b>.</p>

## 11.2 Managing the oven remote control

### **WARNING!**

The remote monitoring function via a mobile device should not be used to replace direct personal supervision of the cooking process in the oven. Always regularly check, in person, what is actually going on in the oven.

Press . The display shows **Remote** to indicate the possibility of remote control via the ConnectLife app.,

### **INFORMATION!**

For safety reasons, some functions are not available via remote access.

- If the oven is in standby mode and you open the oven door, the remote control option has to be enabled again.
- If oven door is opened during the baking process, the remote control option on the oven is disabled.
- Any user activity on the control unit will automatically disable the remote control option on the oven.
- Cancellation or completion of the baking program or process is the only option that remains available regardless of whether remote control is enabled or not.
- Remote control is disabled when using a microwave system (not applicable to combined microwave systems).
- 

### **WARNING!**

Always make sure the oven is used correctly and in compliance with the instructions, especially when using remote control. Do not run the oven via remote access unless you are certain about what exactly is in the oven.

Wi-Fi status	Wi-Fi symbol on the display unit
Wi-Fi is disabled.	Wi-Fi is constantly dimly lit.
Wi-Fi is enabled and it is successfully connected to the server.	The Wi-Fi symbol is constantly fully lit.

Table continued from last page

<b>Wi-Fi status</b>	<b>Wi-Fi symbol on the display unit</b>
Wi-Fi is enabled and: <ul style="list-style-type: none"><li>• a connection to the server is being established,</li><li>• is in the state of setting up or establishing connections,</li><li>• there is no connection to the server.</li></ul>	Wi-Fi icon is fully lit and flashes.
Remote control of the oven is not enabled.	REMOTE symbol is not lit on the display unit.
Remote control of the oven is enabled.	REMOTE sign is fully lit on the display unit.

## 12. General tips and advice for baking

### Equipment:

- Use equipment made of heat-resistant non-reflective materials (supplied baking trays and dishes, enamel-coated cookware, tempered glass cookware). Bright-coloured materials (stainless steel or aluminium) materials reflect heat. As a result, thermal processing of food in them is less effective.
- Always insert the baking sheets and trays to the end of the guides. When baking on the wire rack, place the baking dishes or trays in the middle of the rack.
- Do not place the baking trays directly onto the oven cavity bottom.
- Do not use the all-purpose deep baking tray on the 1st guide level while the appliance is operating.
- Do not cover the oven cavity bottom or the wire rack with aluminium foil.
- Always place the baking dishes onto the wire rack.
- When cooking on several levels at the same time, insert the deep all-purpose baking tray into the lower level.
- If you are using parchment paper, make sure it is resistant to high-temperatures. Always trim it accordingly. Parchment paper prevents the food from sticking to the baking tray and makes it easier to remove the food from the baking tray.
- When baking directly on the wire rack, insert the all-purpose deep tray one level lower to serve as a drip tray.

### Food preparation:

- For optimum food preparation, we recommend observing the guidelines specified in the cooking table. Choose the lower specified temperature and the shortest specified cooking time. When this time expires, check the results and then adjust the settings as necessary.
- When cooking according to recipes from older cookbooks, use the bottom and top heater system (as in conventional ovens) and set the temperature 10 °C lower than specified in the recipe.
- When cooking larger cuts of meat or pastry with higher water content, a lot of steam will be generated inside the oven, which in turn may condense on the oven door. This is a normal phenomenon which will not affect the operation of the appliance. After the cooking process, wipe the door and the door glass dry.

### Efficient use of energy

- Preheat the oven only if indicated in the recipe or in the tables in this instruction manual. If you are using quick preheating, do not put food in the oven until the oven is fully heated, unless otherwise recommended. When heating an empty oven, a lot of energy is consumed, so if possible, we recommend that you prepare several dishes in a row or several dishes at the same time.
- Remove all unnecessary equipment from the oven during baking
- Unless it is absolutely necessary, do not open the oven door during baking.
- With longer cooking programs, you can switch off the oven approximately 10 minutes before the end of cooking time to make use of the accumulated heat.

### Use of microwaves

- Use suitable cookware (glass, ceramic etc.).
- Use cookware with a lid for cooking vegetables. Add 1 tablespoon of water per 100 g of food.
- Turn or stir the food during the defrosting process.

## 12.1 Cooking table

NOTE: Dishes requiring a fully pre-heated oven are indicated with a single asterisk in the table. \* Dishes that only require a 5-minute preheating of the oven are indicated with two asterisks. \*\*. In this case, do not use the quick preheating mode.























Dish			 °C/W	 min
<b>PASTRY AND BAKERY PRODUCTS</b>				
<b>pastry/cakes in moulds</b>				
sponge cake	1		190-210	30-50
pie with filling	1		170-180	60-80
marble cake	1		160-170	30-40
cake with leavened dough, Gugelhupf (Bundt cake, pound cake)	1		170-180	50-60
open pie, tart	1		180-190	40-50
brownies	2		170-180 *	25-35
<b>pastry on baking trays and dishes</b>				
strudel	2		170-180	55-65
strudel, frozen	2		200-210	45-60
sponge roll	2		170-180	15-25
buchteln	1		180-190	30-40
<b>biscuits, cookies</b>				
cupcakes	2		160-170 *	20-35
cupcakes, 2 levels	2, 3		140-150 *	25-45
yeast-leavened small pastry	2		190-200	20-30
yeast-leavened small pastry, 2 levels	2, 3		170-180	20-30
puff pastry	2		200-220	25-45
puff pastry, 2 levels	2, 3		160-170	20-30
<b>cookies/biscuits</b>				
pipéd cookies	2		140-150 *	25-40
pipéd cookies, 2 levels	2, 3		140-150 *	30-45

Table continued from last page

























Dish			 °C/W	 min
cookies/biscuits	2		180-190	20-30
biscuits, 2 levels	2, 3		160-170 *	15-25
meringue	2		80	120-140
meringue, 2 levels	2, 3		70	120-140
macarons	2		140	13-18
macarons, 2 levels	2, 3		140	15-20
<b>bread</b>				
rising and proofing	2		35-40	30
bread on a baking tray	1		190-200	50-60
bread in a tin	1		190-200	30-45
flatbread (focaccia)	2		210-220 *	25-35
fresh bread rolls (Semmel/morning rolls)	2		190-200 *	20-30
toast	4		High*	0.5-3
open sandwiches	3		Medium	6-10
<b>pizza and other dishes</b>				
homemade pizza	1		275 *	10-17
homemade pizza, 2 rack levels	2, 3		210-220 *	30-40
frozen pizza	2		210-230	10-20
frozen pizza, 2 levels	2, 3		200-220	15-25
savoury pie, quiche	1		190-210	50-60
burek	1		180-200	30-40
<b>MEAT</b>				
<b>beef and veal</b>				
beef roast (loin, rump), 1.5 kg	1		160-180	130-160
braised beef, 1.5 kg	1		190-210	90-110

Table continued from last page

























Dish			 °C/W	 min
sirloin, medium done, 1 kg	2		170-190 *	40-60
beef roast, slow cooked	1		120-140 *	250-300
beef steaks, well done, thickness 4 cm	3		High	25-35
burgers, thickness 3 cm	3		High	20-35
veal roast, 1.5 kg	2		180-200	100-120
<b>pork</b>				
pork roast, rump, 1.5 kg	1		200-210	120-170
pork roast, shoulder, 1.5 kg	1		180-200	140-170
pork loin, 400 g	1		80-100 *	80-100
pork roast, slow cooked	1		100-120 *	200-230
pork ribs, slow cooked	1		120-140 *	210-240
pork chops, thickness 3 cm	3		Medium	20-30
<b>poultry</b>				
poultry, 1.2–2.0 kg	1		200-210/360	45-60
poultry with stuffing, 1.5 kg	1		170-190	100-120
poultry, breast	2		190-210	50-60
chicken thighs	1		190-200/600	20-30
chicken wings	2		210-220	20-35
poultry, breast, slow cooked	2		100-120 *	60-90
<b>meat dishes</b>				
meat loaf, 1 kg	2		170-190	75-90
grill sausages, bratwurst	3		High	8-15
<b>FISH AND SEAFOOD</b>				
whole fish, 350 g	3		230-240/360	12-17
fish fillet, thickness 1 cm	3		Low	8-12

Table continued from last page







































Dish			 °C/W	 min
fish steak, thickness 2cm	3		Medium	10-15
scallops	3		230 *	5-10
shrimps	3		Low	3-10
<b>VEGETABLES</b>				
baked potatoes, wedges	2		210-220 *	35-45
baked potatoes, halved	2		210-220	30-40
stuffed potato (jacket potato)	3		190-200	30-40
French fries, home-made	2		210-220	25-35
mixed vegetables, wedges	3		190-200	30-40
stuffed vegetables	3		190-200	30-40
steamed vegetables	1		600-750	10-20
<b>CONVENTIONAL PRODUCTS – FROZEN</b>				
French fries	3		200-210	25-35
french fries, 2 levels	2, 3		200-210	35-45
chicken medallions	2		210-220 *	15-20
fish fingers	2		210-220	15-25
lasagne, 400 g	2		200-210	30-40
diced vegetables	2		190-200	20-30
croissants	2		170-180	18-23
<b>BAKED PUDDINGS, SOUFFLÉS AND DISHES AU GRATIN</b>				
potato moussaka	1		180-200/360	35-45
lasagne	1		180-200/360	30-40
sweet baked pudding	1		750	15-25
sweet soufflé	2		180 *	15-20

Table continued from last page

Dish			 °C/W	 min
dishes au gratin	2		170-190	30-40
stuffed tortillas, enchiladas	2		180-200	20-35
grilling cheese	3		Low**	5-7/5-7
<b>OTHER</b>				
popcorn	1		1000	3-4
preservation	2		180	30
sterilization	2		1000	2
cooking in a bain-marie (double boiler)	1		150-170 *	/
reheating	1		300-600	/
plate warming	2		75	15
defrosting	1		90-180	/

# 13. Cleaning and maintenance



**WARNING!**

Before manual cleaning, unplug the appliance from the power mains and wait for it to cool down.

**Children should not clean the appliance or perform maintenance tasks without proper supervision.**

- For easier cleaning, oven cavity and baking tray are coated with special enamel for a smooth and resistant surface.
- Regularly clean the appliance and use warm water and hand dishwashing liquid to remove larger impurities and limescale. Use a clean soft cloth or sponge cloth.
- Never use aggressive or abrasive cleaners and accessories (abrasive sponges and detergents, stain and rust removers, scrapers for glass ceramic plates).
- Food residue (fat, sugar, protein) can ignite during the use of the appliance. Therefore, remove larger chunks of dirt from the oven interior and accessories before each use.
- Oven equipment is dishwasher-safe. Pull-out guides are not suitable for this type of cleaning.

<b>Exterior of the appliance</b>	Use hot soapy water and a soft cloth to remove impurities and wipe the surfaces dry.
<b>Interior of the appliance</b>	For stubborn dirt or grime, use conventional oven cleaners. After using such agents, wipe the appliance thoroughly with a wet cloth to remove any residual cleaning agents.
<b>Utensils and guides</b>	Clean with hot soapy water and a damp cloth. In case of persistent dirt, we recommend prior soaking and the use of a brush.
If the cleaning results are not satisfactory, repeat the cleaning process.	



**WARNING!**

Do not use corrosive, abrasive, or aggressive cleaning agents when cleaning the oven's front panel. Such agents may damage the surface, cause scratches, or permanently alter its appearance.

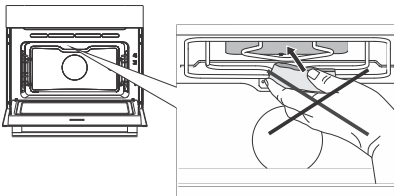

Never use aggressive cleaners, abrasive cleaners or sponges, stain and rust removers etc. on the oven cavity ceiling cover.

## 13.1 Cleaning the oven (Steam Clean)

This program makes it easier to remove any stains from inside the oven.

The function is the most effective if used regularly, after each use.

Before running the cleaning program, remove all large visible chunks of dirt and food residues from the oven cavity.

### **WARNING!**

Use the Steam Clean system when the oven has fully cooled down.

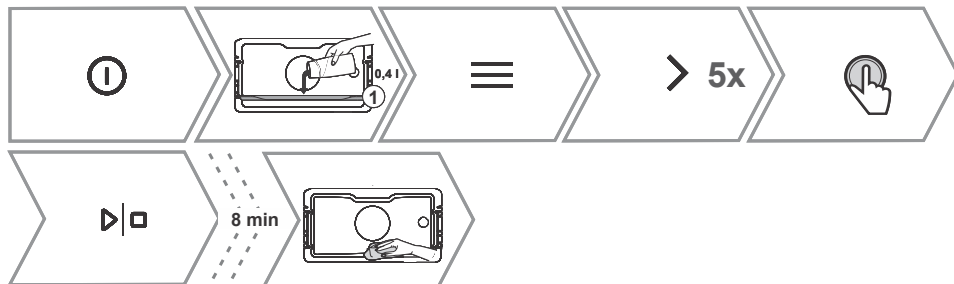

1.	Insert the glass baking tray into the first guide level and pour 0.4 l of warm water into it.
2.	Switch on the appliance and select  . Rotate the KNOB to select <b>Cleaning</b> . Confirm by pressing the KNOB to enter the submenu.
3.	Confirm with <b>OK</b> . The programme operates for 8 minutes. After the end of the programme, the display shows <b>End</b> .
4.	When the program is completed, carefully remove the baking tray, using oven mitts (there can still be some water on the baking tray). Wipe down the stains with damp cloth and soapsuds. Thoroughly wipe the appliance with a wet cloth to remove all cleaner residue. If the cleaning process is not successful (in case of particularly stubborn dirt), repeat it.

## 13.2 Removing and cleaning the wire guides

### **INFORMATION!**

When removing the guides, take care not to damage the enamel coating.

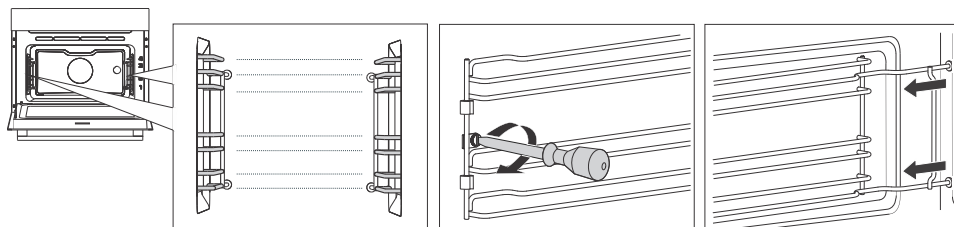

1.	Undo the screw. Use a screwdriver.
2.	Remove the guides from the holes in the back wall.

Table continued from last page

NOTE: Take care not to lose the spacers fitted on the wire guides. Replace the spacers after cleaning; otherwise, sparks may appear.  
After cleaning, re-tighten the screws on the guides with a screwdriver. When replacing the wire guides, make sure you mount them on the same side they were installed on prior to removal.

## 13.3 Replacing the bulb

The light bulb is a consumable and is not covered by warranty. Before changing the bulb, remove any utensils from the oven.

Halogen lamp: G9, 230 V, 25 W

The oven is fitted with a halogen lamp.

This product contains a light source of energy efficiency class (G).



### WARNING!

**Only replace the light bulb when the appliance is disconnected from the power supply. Be careful not to damage the enamel. Use protection to avoid burns.**

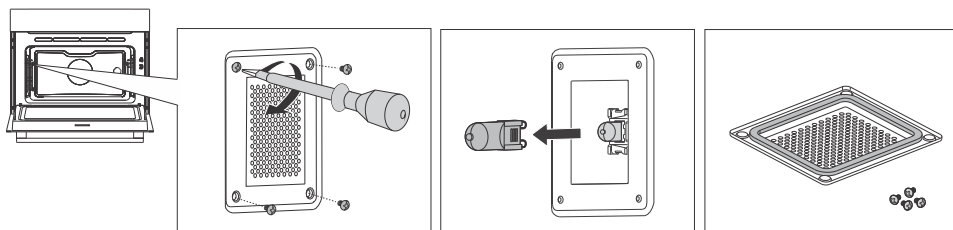

- |    |  |
|----|--|
| 1. | Undo the four screws. Remove the cover and the glass.        |
| 2. | Remove the halogen light bulb and replace it with a new one. |

NOTE: There is a gasket on the lid that should not be removed from the lid. The gasket must fit on the wall of the oven space.

# 14. Troubleshooting

During the warranty period, only a service center authorized by the manufacturer may carry out any repairs.

- Before making any repairs, make sure the appliance is disconnected from the power mains either by removing the fuse or by disconnecting the power plug from the wall outlet.
- Any unauthorized repairs of the appliance may result in electric shock and short circuit hazard; therefore, do not perform them. Leave such work to an expert or a service technician.
- In case of minor problems with appliance operation, check this manual to see if you can fix the problem yourself.
- If the appliance is not operating properly or at all due to inappropriate operation or handling, a visit from a service technician shall not be free of charge, even during the warranty period.
- Save the instructions for future reference and pass them on to any subsequent owners or users of the appliance.
- Following is some advice on rectifying some common problems.

## 14.1 Troubleshooting table

Problem/error	Cause
<b>The main fuse in your home trips often.</b>	Call a service technician.
<b>The oven lighting does not work.</b>	The process of changing the light bulb in the oven is described in the chapter Replacing the bulb.
<b>Control unit is not responding, the screen is frozen.</b>	Disconnect the appliance from the power mains for a few minutes (undo the fuse or switch off the main switch); then, reconnect the appliance and switch it on.
<b>The display shows the error Err X. In case of a double-digit error code, the display will show Err XX.</b>	There is an error in the electronic module operation. Disconnect the appliance from the power mains for a few minutes. If the error is still indicated, call a service technician.
<b>Sparks appear in the oven.</b>	Make sure all lamp covers are securely fastened and that all spacers are fitted on the wire guides. Make sure the guides in the oven are correctly placed.
<b>Insufficient roasting on the bottom side.</b>	Make sure that the correct cooking programme has been selected.
<b>Steam accumulating on the display when opening the door.</b>	Open the oven door completely, do not keep it somewhat closed.
<b>Large amount of steam when cooking.</b>	Certain foods contain a lot of water, so a large amount of steam is normal.
<b>Meat probe appears on the screen, although it is not in use.</b>	The cause of the error may be drops or dirt in the socket of the meat probe. We recommend inserting and removing the meat probe several times to clean the socket.
If the problems persist despite observing the above advice, call an authorized service technician. Repair or any warranty claim resulting from incorrect connection or use of the appliance shall not be covered by the warranty. In this case, the user will cover the cost of repair.	

## 14.2 Label – appliance information

A rating plate with basic information about the appliance is attached to the edge of the oven. Precise information on appliance type and model can also be found on the warranty sheet.

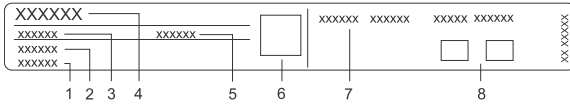

- |                  |                              |
|------------------|------------------------------|
| 1. Serial number | 5. ID/code                   |
| 2. Model         | 6. QR code                   |
| 3. Type          | 7. Technical information     |
| 4. Brand         | 8. Compliance labels/symbols |

## 15. Compliance information

Radio equipment type:	Built-in WiFi/BLE module
<b>Wi-Fi indicator</b>	
Operating frequency range:	2412 ~ 2472 MHz
Maximum output power:	19.99 dBm EIRP
Maximum antenna gain:	3.26 dBi
<b>Bluetooth indicator</b>	
Frequency range:	2402 ~ 2480 MHz
Carrier Output:	10.00 dBm
Emission type:	F1D

The company declares that the device with the function Connectlife complies with the essential requirements and other relevant provisions of Directive 2014/53/EU. The detailed Declaration of Conformity can be found at the web address <https://auid.connectlife.io> on the page of your device among the additional documents.



### INFORMATION!

The project uses the LVGL graphics library as its graphical user interface.

## 16. Environment protection



Our product packaging is made of environmentally friendly materials that can be recycled, disposed of, or destroyed without any hazard to the environment. To this end, packaging materials are labelled appropriately.

**The symbol** on the product or its packaging indicates that the product should not be treated as normal household waste. Take the product to an authorized collection centre for waste electric and electronic equipment processing.

Correct **disposal** of the product will help prevent any negative effects on the environment and health of people, which could occur in case of incorrect product removal. For detailed information on removal and processing of the product, please contact the relevant municipal body in charge of waste management, your waste disposal service, or the store where you bought the product.

We reserve the right to any changes and errors in the instructions for use.

# 17. Cooking test

EN60350-1: Only use equipment supplied by the manufacturer.

Always insert the baking tray all the way to the end position on the wire guide. Place pastry or cakes baked in moulds as shown in the image.

\* Preheat the appliance until it reaches the set temperature. Do not use the rapid preheat mode.

\*\* Preheat the appliance for 10 minutes. Do not use the rapid preheat mode.

\*\*\* Turn after 2/3 of cooking time.





























BAKING					
Dish	Equipment		 °C/w	 min	
shortbread – single rack	shallow baking tray	2	140-150*	25-40	
shortbread – single rack	shallow baking tray	2	140-150*	25-40	
shortbread – two racks/levels	shallow baking tray	2, 3	140-150*	30-45	
small cakes – single rack	shallow baking tray	2	160-170*	20-35	
small cakes – single rack	shallow baking tray	2	160-170*	20-35	
small cakes – two racks/levels	shallow baking tray	2, 3	140-150*	25-40	
sponge cake	round metal mould, diameter 26 cm/wire rack	1	160-170*	20-35	
sponge cake	round metal mould, diameter 26 cm/wire rack	2	160-170*	20-35	
apple pie	2 × round metal mould, diameter 20cm/wire rack	1	170-180	60-80	
apple pie	2 × round metal mould, diameter 20cm/wire rack	2	170-180	60-80	
BROILING					
toast	wire rack	4	High**	0.5–3	
beef burgers	wire rack + shallow baking sheet as drip tray	3	High	20-35**	
THERMAL PROCESSING WITH MICROWAVES					
custard cream, 1000 g	glass baking dish, 25 × 25 cm, uncovered + glass baking tray	1	360	25-35	
sponge cake	round glass baking dish, diameter 22 cm, uncovered + glass baking tray	1	360	15-25	
meat loaf, 900 g	glass baking dish, 25 × 12.5 cm, uncovered + glass baking tray	1	600 360	10 10-15	
defrosting ground meat, 500 g	glass baking tray	1	180 90	8 13-18	

Table continued from last page

BAKING						
defrosting raspberries, 250 g	glass baking dish, uncovered + glass baking tray	1	180	6-9		

BAKING WITH COMBINED SYSTEMS						
Dish	Equipment		 °C	 W	 min	<input type="checkbox"/>
potatoes au gratin	round glass baking dish, diameter 22 cm, uncovered + glass baking tray	1	180-190	600	25-40	
cake	round glass baking dish, diameter 22 cm, uncovered + glass baking tray	1	180-190	180	17-25	
chicken, 1.2 kg	glass baking dish, uncovered + glass baking tray	1	210-220	360	45-55	

# **gorenje**



941055-a10

CE