



## Safety precautions

### SAFETY PRECAUTIONS

- This product must be installed by an installation professional from an LG authorised service center.
- Any issues stemming from an installation by an unauthorised person is the responsibility of the user and will not be covered by warranty.
- The following safety precautions are to prevent any unforeseen contingencies.
- This product has been designed for commercial purposes. This product has successfully cleared the EMI test.

#### WARNING

It can result in serious injury or death when the directions are ignored.

#### CAUTION

It can result in minor injury or product damage when the directions are ignored.

#### WARNING

##### Installation

- To reinstall the product, please contact the dealer from where you purchased the product, or a service center.
  - Installation of the product by an unauthorised person may result in fire, electric shock, explosion, injury, or a malfunctioning of the product.
- Do NOT twist or damage the power cord.
  - Follow the below precautions properly; else it might result in a fire disaster, risk of incurring electric shock injuries or product malfunctioning.
- For electrical work, please contact the dealer from where you purchased the product, or a service center.
  - Follow the below precautions properly; else it might result in a fire disaster, risk of incurring electric shock injuries or product malfunctioning.
- Install the product in an area shielded from rain.
  - Follow the below precautions properly; else it might result in a fire disaster, risk of incurring electric shock injuries or product malfunctioning.
- Do NOT install the product in a humid area.
  - Follow the below precautions properly; else it might result in a fire disaster, risk of incurring electric shock injuries or product malfunctioning.
- For installation of the product, please contact the dealer from where you purchased the product, or a service center.
  - Installation of the product by an unauthorised person may result in fire, electric shock, explosion, injury, or a malfunctioning of the product.
- For electrical work, it is advisable for the electrician to refer the installation manual and specified circuit diagram.
  - Using an unsuitable cord, or having a non-professional work on the electricals may result in fire or electrical shock.
- Do NOT place the product near a fire source.
  - It may result in combustion.
- If the product is installed in a hospital or a communication base station, shield the product from electrical noise by providing sufficient protective equipment.
  - Protective equipment prevents the product from malfunctioning.
- Securely install the product.

- If the product is not secured during installation, it may fall or malfunction.
- Read the manual thoroughly to correctly install the product.
  - Follow the below precautions properly; else it might result in a fire disaster, risk of incurring electric shock injuries or product malfunctioning.
- When wiring the product, do not use a non-standard cable, nor extend the cable excessively.
  - Follow the below precautions properly; else it might result in a fire disaster, risk of incurring electric shock injuries or product malfunctioning.
- Securely install the power cord and communication cable.
  - Follow the below precautions properly; else it might result in a fire disaster, risk of incurring electric shock injuries or product malfunctioning.
- Do NOT connect the power cord to the communication terminal.
  - Follow the below precautions properly; else it might result in a fire disaster, risk of incurring electric shock injuries or product malfunctioning.
- Do NOT install the product in an area near combustible gases.
  - Follow the below precautions properly; else it might result in a fire disaster, risk of incurring electric shock injuries or product malfunctioning.

## Use

- Do NOT place a heavy object on the power cord.
  - Follow the below precautions properly; else it might result in a fire disaster, risk of incurring electric shock injuries, product malfunctioning or damage to property.
- Do NOT change or extend the power cord arbitrarily.
  - Follow the below precautions properly; else it might result in a fire disaster, risk of incurring electric shock injuries, product malfunctioning or damage to property.
- Use the cord specific to the product.
  - Using an unauthorised non-standard cord may result in a fire or electric shock.
- Do NOT use a heat device near the power cord.
  - Follow the below precautions properly; else it might result in a fire disaster, risk of incurring electric shock injuries, product malfunctioning or damage to property.
- Ensure that water never gets into the product.
  - Follow the below precautions properly; else it might result in a fire disaster, risk of incurring electric shock injuries, product malfunctioning or damage to property.
- Do NOT place any container with liquid on the product.
  - Follow the below precautions properly; else it might result in a fire disaster, risk of incurring electric shock injuries, product malfunctioning or damage to property.
- Do NOT touch the product with wet hands.
  - Follow the below precautions properly; else it might result in a fire disaster, risk of incurring electric shock injuries, product malfunctioning or damage to property.
- Use standard components.
  - Follow the below precautions properly; else it might result in a fire disaster, risk of incurring electric shock injuries, product malfunctioning or damage to property.
- If the product has been submerged in water, you should contact a service center.
  - Follow the below precautions properly; else it might result in a fire disaster, risk of incurring electric shock injuries, product malfunctioning or damage to property.
- Do NOT shock the product.
  - Follow the below precautions properly; else it might result in a fire disaster, risk of incurring electric shock injuries, product malfunctioning or damage to property.
- Do NOT store or use any combustible gas or flammable substances near the product.
  - Follow the below precautions properly; else it might result in a fire disaster, risk of incurring electric shock injuries, product malfunctioning or damage to property.

- Do NOT disassemble, repair, or revamp the product arbitrarily.
  - Follow the below precautions properly; else it might result in a fire disaster, risk of incurring electric shock injuries, product malfunctioning or damage to property.
- Children and the elderly should use the product under the supervision of a guardian.
  - Follow the below precautions properly; else it might result in a fire disaster, risk of incurring electric shock injuries, product malfunctioning or damage to property.
- The guardian should prevent children from accessing the product.
  - The product can be damaged or it may fall, causing injury to children.
- Note that the operating temperature range of the product is between 0 and 40 °C (32 and 104 °F).
  - If the product is used outside this range, the product may be severely damaged.
- Do NOT depress the switch or button using a sharp object.
  - Follow the below precautions properly; else it might result in a fire disaster, risk of incurring electric shock injuries, product malfunctioning or damage to property.
- Do NOT wire the product while it is turned ON.
  - It may cause a fire or electric shock.
- If the product sounds different or emanates an unpleasant odor, stop using the product.
  - Follow the below precautions properly; else it might result in a fire disaster, risk of incurring electric shock injuries, product malfunctioning or damage to property.
- Do NOT place a heavy object on the product.
  - Follow the below precautions properly; else it might result in a fire disaster, risk of incurring electric shock injuries, product malfunctioning or damage to property.
- Do NOT spray water on the product, or clean it with a water-soaked cloth.
  - Follow the below precautions properly; else it might result in a fire disaster, risk of incurring electric shock injuries, product malfunctioning or damage to property.
- Do NOT use the product for the preservation of animals and plants, precision instruments, art pieces, or for other special purposes.
  - Follow the below precautions properly; else it might result in a fire disaster, risk of incurring electric shock injuries, product malfunctioning or damage to property.
- Dispose the packing material safely.
  - Follow the below precautions properly; else it might result in a fire disaster, risk of incurring electric shock injuries, product malfunctioning or damage to property.

## CAUTION

### Installation

- Securely install the product in an area where the weight of the product can be supported.
  - The product may fall and be destroyed.
- Do NOT use the product where there is oil, steam, or sulfuric gas.
  - It may affect the product's performance, or damage it.
- Check the rated power capacity.
  - It may cause a fire, or a product malfunction.
- Be careful not to drop or damage the product when moving it.
  - The product may malfunction or the person may sustain an injury.
- Ensure that the cord is connected securely to protect the product from dew, water, or insects.
  - If a foreign substance gets inside, it may cause an electric shock or the product may malfunction.
- This appliance is not intended for use by persons (including children) with reduced physical, sensory or mental capabilities or lack of experience and knowledge, unless they have been given supervision or instruction concerning use of the appliance by a person responsible for their safety. Children should be supervised to ensure that they do not play with the appliance.

- Installation work must be performed in accordance with the national wiring standards by authorized personnel only. This equipment shall be provided with a supply conductor complying with the national regulation.

### Use

- Do NOT clean the product with solvent based detergents; instead use cloth.
  - The use of a solvent-based detergent may cause a fire or deform the product.
- Do NOT touch the panel using a pointed or sharp object.
  - It can result in an electric shock, or the product may malfunction.
- Do NOT expose the product to a metal substance.
  - The product may malfunction.
- When sterilizing or disinfecting, stop using the product.
  - The product may work abnormally.
- Do NOT touch internal components of the product.
  - The product may malfunction.
- Check whether the product is in a proper condition after using the product for an extended period of time.
  - Deteriorating condition of the product, may cause injury to the user.
- Do NOT leave the product near a flower base, water bottle, or any other liquids.
  - It may cause a fire or electric shock.
- If the liquid crystal of the product is broken, please do NOT allow the product to come in contact with your skin (hands, face).
  - This may result in personal injury or property damage.
- This appliance can be used by children aged from 8 years and above and persons with reduced physical, sensory or mental capabilities or lack of experience and knowledge if they have been given supervision or instruction concerning use of the appliance in a safe way and understand the hazards involved. Children shall not play with the appliance. Cleaning and user maintenance shall not be made by children without supervision.
- The appliance shall be disconnected from its power source during service and when replacing parts.

## Class A device

### NOTE

This equipment has been tested and identified as complying with the limits for a Class A digital device, and acts in accordance with part 15 of the FCC Rules. These rules are designed to provide protection for the equipment from any detrimental damages while operating in a commercial environment. This equipment generates, uses, and can emit radio frequency energy.

If it is not installed and used according to the instruction manual, it may cause detrimental damage to the radio communications. Ensure that this product is NOT operated within residential premises as it might emit dangerous radiations. In such a scenario, the user is responsible for damage repair.

### CAUTION

Changes or modifications that are not approved by the manufacturer responsible for compliance could render the user authority as invalid.



#### Disposal of your old appliance

1. This crossed-out wheeled bin symbol indicates that waste electrical and electronic products (WEEE) should be disposed of separately from the municipal waste stream.
2. Old electrical products can contain hazardous substances so correct disposal of your old appliance will help prevent potential negative consequences for the environment and human health. Your old appliance may contain reusable parts that could be used to repair other products, and other valuable materials that can be recycled to conserve limited resources.
3. You can take your appliance either to the shop where you purchased the product, or contact your local government waste office for details of your nearest authorised WEEE collection point. For the most up to date information for your country please see [www.lg.com/global/recycling](http://www.lg.com/global/recycling)



#### Disposal of waste batteries/accumulators

1. This symbol may be combined with chemical symbols for mercury (Hg), cadmium (Cd) or lead (Pb) if the battery contains more than 0.0005% of mercury, 0.002% of cadmium or 0.004% of lead.
2. All batteries/accumulators should be disposed separately from the municipal waste stream via designated collection facilities appointed by the government or the local authorities.
3. The correct disposal of your old batteries/accumulators will help to prevent potential negative consequences for the environment, animal and human health.
4. For more detailed information about disposal of your old batteries/accumulators, please contact your city office, waste disposal service or the shop where you purchased the product. (<http://www.lg.com/global/sustainability/environment/take-back-recycling/global-network-europe>)



## Functions and Specification

### AC Smart 5

AC Smart 5 is a central controller that can manage individual or group of maximum of 128 units in one space.

AC Smart 5 can monitor or control the units installed in each room of a building from a place such as building management office or school administration office.

#### [AC Smart 5 Functions]

- Web Server Embedded Function
- Devices that can be interfaced

#### [AC Smart 5 Components]

- Components

#### [Name of Each Part of AC Smart 5]

- Name of Each Part

#### [AC Smart 5 Hardware Specification]

- Hardware Specification



## Web Server Embedded Function

Without installing a separate program, you can use web browser to input IP address of AC Smart 5 in the address window to access AC Smart 5 web server for device control and monitoring.

- Control of Max. of 128 air conditioner units
- Error and Operation Status Monitoring
- Peak/Demand Power Control
- System Setting Function



## Devices that can be interfaced

The devices of AC Smart 5 that can be interfaced are as follows.

Device	AC Smart 5
AC Ez(Touch)	o
Simple Central Controller	o
AC Manager 5	o
Air conditioner	o
HRV	o
AWHP	o
AHU	o
Chiller	o (with chiller option S/W applied)
EXP. I/O	o

## Components

The components of the following figure are included in AC Smart 5 package box.

Open the package box, and check if all corresponding components are included.

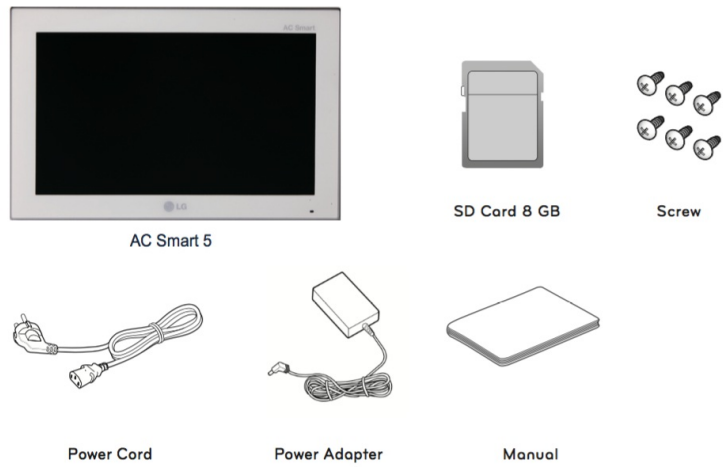

### Note

Components or options may differ from the actual product picture.

### Caution

The SD card provided by our company is for backup and restoration of data when service is provided by qualified service engineer. Do not use on other purpose.



## Name of Each Part

AC Smart 5 is composed as the following form.

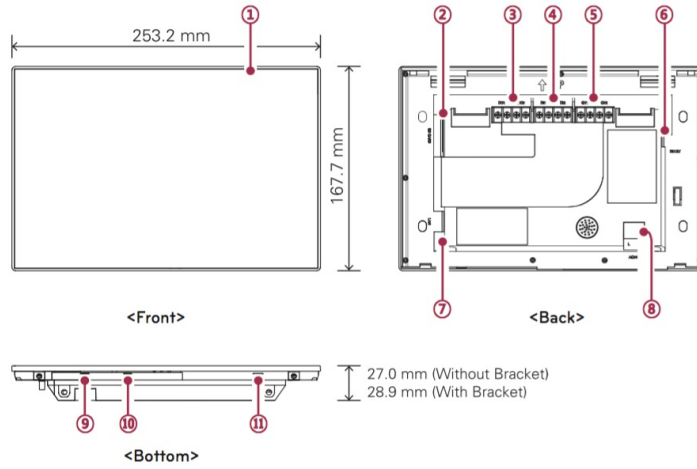

No.	Category	Contents
①	Touch Screen	<ul style="list-style-type: none"> <li>• 10.2 inch LCD control panel</li> <li>• AC Smart 5 control and information display</li> </ul>
②	SD Memory Slot	SD card memory slot
③	DO Port	2CH DO port
④	DI Port	2CH DI port
⑤	RS-485 Port	<ul style="list-style-type: none"> <li>• 2CH 485 port (CH1: AHU, CH2: devices other than AHU)</li> <li>• CH1 default setting : LGAP_AHU / CH2 default setting : LGAP I</li> <li>• To change default setting, refer to the contents of 'Device Setting - AC Smart 5 Editing' in the user manual provided in [Help] category.</li> </ul>
⑥	12 V  Input Port	12 V  power input port
⑦	LAN Port	LAN cable port for Ethernet connection (100Mbps/10Mbps)
⑧	24 V~ Input Port	24 V~ power input port
⑨	Micro USB Port (for service)	Port for upgrading software and storing floor plans, reports, statistics, etc. (It needs cable to connect USB memory sticks, supporting USB 2.0 or later)
⑩	Mini USB Port	PC port for debugging software
⑪	Power ON/OFF	<ul style="list-style-type: none"> <li>• If you press less than 9 seconds, AC Smart 5 LCD backlight control</li> <li>• Push 10 seconds or more to reset AC Smart 5.</li> <li>• If you are not going to use AC Smart 5 for a long time, it is recommended that the product be turned off to prolong the LCD backlight's life.</li> </ul>



## Hardware Specification

AC Smart 5 hardware specification is as follows.

Category	Contents
CPU	<ul style="list-style-type: none"><li>• ARM Cortex A9 1 GHz</li><li>• Dual Core</li></ul>
MEMORY	2 GB
Storage	16 GB
LCD	10.2 inch(1024 x 600) TFT LCD
Speaker	Mono
RS-485	2 Port
USB/SD	<ul style="list-style-type: none"><li>• Micro USB 1EA (for external USB memory connection, for service)</li><li>• Mini USB 1EA</li><li>• SD Card 1EA</li></ul>
Ethernet	10 / 100 BASE-T
DI	2 Port
DO	2 Port
Touch Screen	C-Type Touch Panel
Button Key	Less than 9 seconds (LCD Power On/Off), 10 seconds (System reset)
POWER	12 V (3.33 A), 24 V~
Operating temperature	0 °C ~ 40 °C
Protection class	IP20



## Installation and Setting

It describes AC Smart 5 Installation and Setting Method.

### [Installation Order]

- Order of AC Smart 5 Installation

### [Connect AC Smart 5]

- Connect AC Smart 5



## Order of Installation

To use AC Smart 5, you need to establish environment for mutual communication between AC Smart 5 and devices (indoor unit, ventilation, DI/DO, DOKIT, system boiler, AHU, I/O module) and register the corresponding devices through the functions of AC Smart 5.

To use AC Smart 5, it shall be installed in the following order.

### STEP 1. Installation environment inspection and device address setting

Before installing AC Smart 5, check network composition with interfacing devices and assign non-overlapping address to the connected devices.

### STEP 2. PI485 setting

Install PI485 and set DIP switch.

### STEP 3. PI485 and AC Smart 5 connection

Connect PI485 and AC Smart 5 through RS-485 cable.

### STEP 4. Log-in and device registration

Log in to AC Smart 5 and register device with address set.

### CAUTION

**The installation of AC Smart 5 must be done by a professional. Be sure to contact a qualified engineer for the installation. If you have a question or request regarding the installation, contact an installation professional at an authorized LG service center or LG Electronics.**

### NOTE

**Maximum node numbers which can be connected to RS485 communication line.**

• Multi V

**Maximum of 16 nodes can be connected to 1 RS485 line.**

• Multi/Single

**Maximum of 32 nodes can be connected to 1 RS485 line.**

• ERV

**Maximum of 32 nodes can be connected to 1 RS485 line.**

## Connect AC Smart 5

You can install AC Smart 5 and its cables as follows.

1. Choose a space for AC Smart 5.  
- Prior to securing AC Smart 5, check if the space is suitable for installing AC Smart 5, an RS485 cable, power cord, and an Ethernet cable.
2. Secure the back panel of AC Smart 5 to the wall under which the RS485 cable is located.

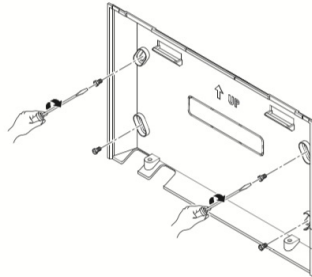

3. Extend the RS485 cable through the top opening of the back panel.

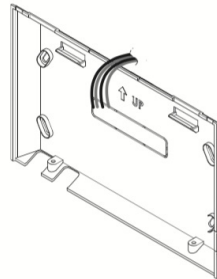

4. Connect the RS485 cable, which is located behind the AC Smart 5, to the RS485 terminal.

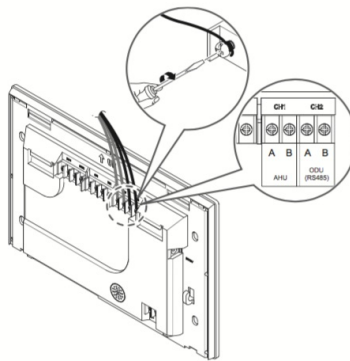

### CAUTION

The RS485 cable has polarity, so be careful about keeping polarity when connecting the cables.

5. To use the network functions (email transmission and web control) provided by AC Smart 5, connect an Ethernet cable to the LAN port on the back of AC Smart 5.

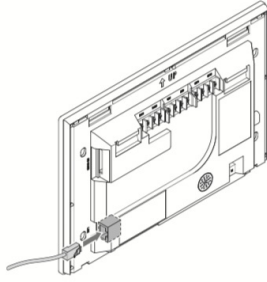

6. Connect the power.

- For global models
- On the back of AC Smart 5, connect the power adapter to the power port.

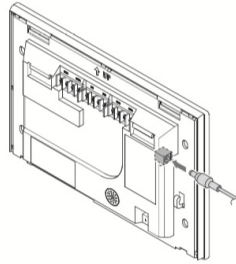

The adaptor is not provided with the AC Smart 5 package sold in the U.S.

#### NOTE

**You can hang the power cord on the power cord hanger located below the power port.**

- For US models
- At the bottom of AC Smart 5, connect the power cord to the power port.

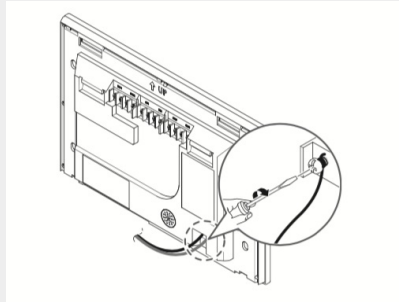

#### NOTE

**In some countries, except for the U.S, you can connect the DC 12 V power to the AC Smart 5 by using the provided adapter. If necessary, connect the AC 24 V power to the AC Smart 5.**

7. After attaching the hook on the top of the main body to the top of the rear panel installed on the wall, please push the top of the main body unit forward for firm attachment.

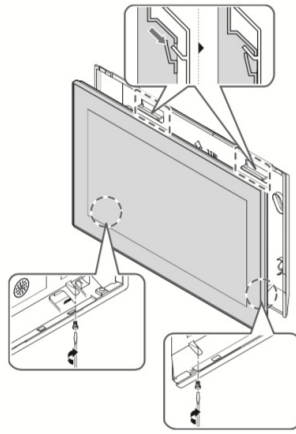

### CAUTION

Please screws 2 points from the bottom of the unit to prevent from falling.

### NOTE

#### Product removal

After removing 2 screws from the bottom of the body, slightly pull the body using the flatblade screwdriver and lift up the body to remove the product.



## Usage (PC)

- LogIn / LogOut
- Account
- Dashboard

## [Control]

- Device Control
- Schedule Control
- InterLocking
- Time limit control

## [Energy]

- Energy Usage
- Energy Navigation
- Peak control

## [History]

- Operation History
- Energy Navigation History
- Operation Trend
- Cycle

## [Setting]

- Device setting
- Group Setting
- System Setting
- Network Setting
- Error Notice Setting
- Administrator Setting
- Additional User Setting
- Screen Setting
- Advance Setting
- TMS Setting
- BACnet/Modbus setting

## Note

- AC Smart 5 may have different features on the web and devices.



You can access to the product with IP address in internet address window to use various central control functions.

## Note

- **Chrome browser is recommended for web control.**
- **For access to web, IP address needs to be set.**
- **At the time of the first access, you need to set password of the manager account.**
- **On every 90 days, popup is provided to change password.**  
**For personal information protection and safe service usage, please change password periodically.**

## Login

Login method is as follows.

1. Please input IP address of the product in the internet address window.
2. Input ID and password in the login window and click **[Login]** button.

## LogOut

Logout method is as follows.

1. In menu, click **[Account]** menu.
2. In Account information window, click **[Logout]** button.

## Account

You can check the information of the currently logged in account.

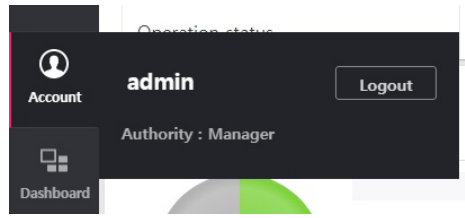

You can check the current operation status and energy usage trend of the equipment installed in the product.

## Operation status

It describes the dash board's current operation status tab composition and functions.

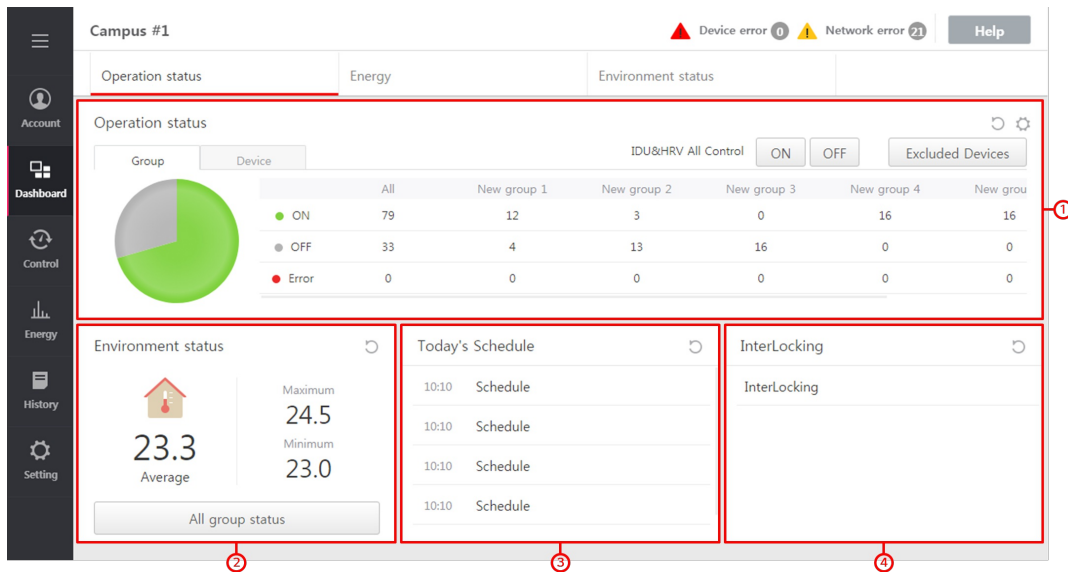

No.	Category	Contents
①	Operation status	Check operation status (ON/OFF/Error) of the equipment installed in the product [group] <ul style="list-style-type: none"> <li>Checking of operation status of each management group designated by user</li> </ul> [device] <ul style="list-style-type: none"> <li>Check operation status of each device designated by the user</li> </ul> All indoor units and ventilation ON / OFF control <ul style="list-style-type: none"> <li>All indoor units and ventilation ON / OFF control</li> <li>When exception device is registered, it is excluded from overall control</li> </ul>
②	Environment status	Checking of average indoor temperature, Max./Min. indoor temperature and group
③	Today's Schedule	Checking today's schedule list
④	InterLocking	Checking of InterLocking list

### [Widget setting]

You can select the monitoring setting through each widget of the dash board.

➔ Operation status Widget

## Energy

It describes the dash board's energy tab composition and functions.

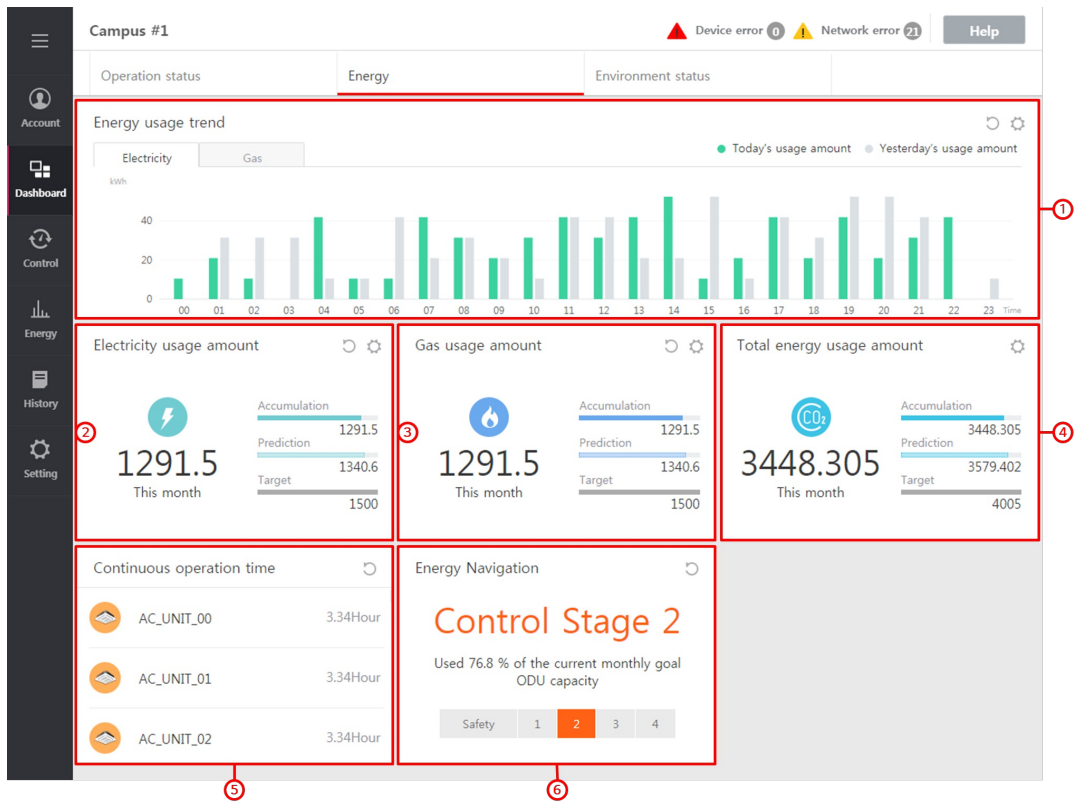

No.	Category	Contents
①	Energy usage trend	Checking of daily, monthly, and yearly trend of electricity/gas usage amount
②	Electricity usage amount	Checking of electricity usage amount accumulation, forecast, and goal
③	Gas usage amount	Checking of gas usage amount accumulation, forecast, and goal
④	Total energy usage amount	Checking of total energy usage amount accumulation, forecast, and goal
⑤	Continuous operation time	Check continuous operation time ranking of indoor unit
⑥	Energy Navigation	Check energy navigation status

### [Widget setting]

You can select the monitoring setting through each widget of the dash board.

- ➔ Energy usage trend Widget
- ➔ Electricity usage amount Widget
- ➔ Gas usage amount Widget
- ➔ Total energy usage amount Widget

## Environment status

It describes the composition and functions of dash board environment status tab

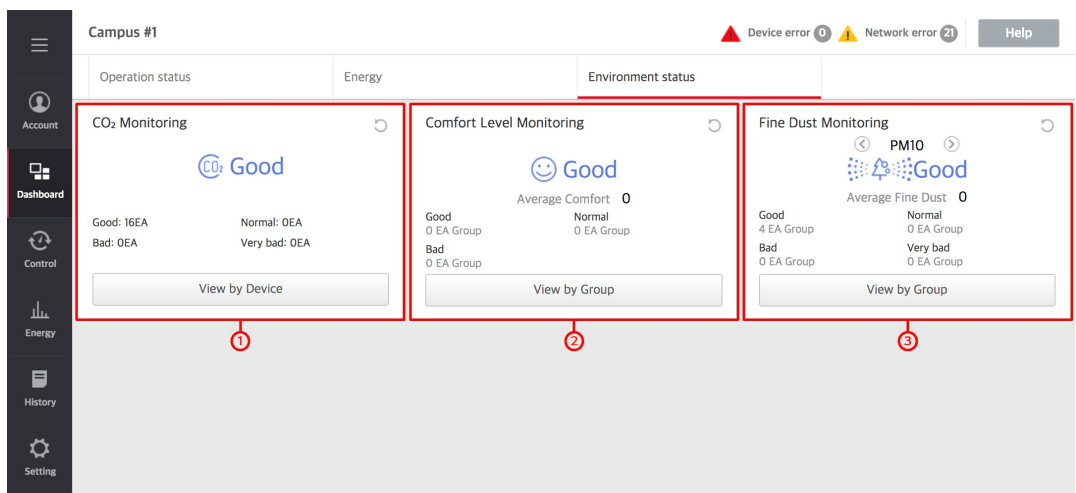

<b>No.</b>	<b>Category</b>	<b>Contents</b>
①	CO <sub>2</sub> monitoring	Check CO <sub>2</sub> status of registered ventilation
②	Comfort Level Monitoring	Check registered indoor unit's pleasantness status
③	Fine dust monitoring	Check registered indoor unit's fine dust status Fine dust is classified to PM10, PM2.5, and PM1.0, and it indicates each status and concentration

## Operation status Widget

You can set the group to monitor the operation status.

1. In the left menu tab, click **[Dashboard] > [Operation status]** menu.
  - The current operation status screen is displayed.
2. Click the current operation status screen's  button.
  - The Widget setting screen is displayed.

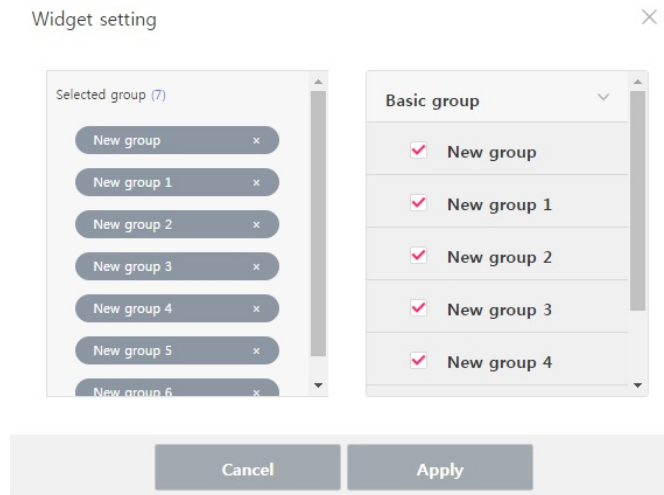

3. Select the group to monitor the operation status.
4. When selection is completed, click **[Apply]** button.

## Energy usage trend Widget

You can select the standard for energy usage amount trend monitoring collection.

1. In the left menu tab, click **[Dashboard] > [Energy]** menu.
  - The energy screen is displayed.
2. Click the energy usage trend screen's  button.
  - The Widget setting screen is displayed.

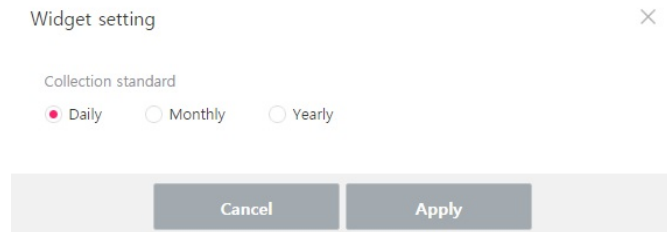

3. Select the collection standard(**Daily/Monthly/Yearly**).
4. When selection is completed, click **[Apply]** button.

## Electricity usage amount Widget

You can select the standard for the electricity usage amount collection standard.

1. In the left menu tab, click **[Dashboard] > [Energy]** menu.
  - The energy screen is displayed.
2. Click the electricity usage amount screen's  button.
  - The Widget setting screen is displayed.

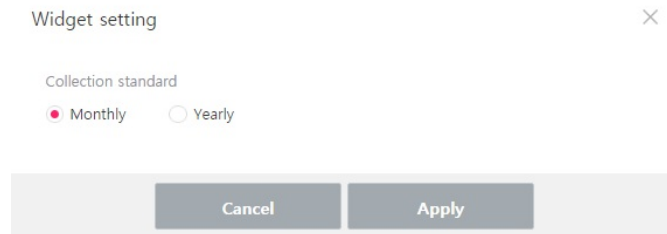

3. Select the collection standard(**Monthly/Yearly**).
4. When selection is completed, click **[Apply]** button.

## Gas usage amount Widget

You can select the standard for gas usage amount collection.

1. In the left menu tab, click **[Dashboard] > [Energy]** menu.
  - The energy screen is displayed.
2. Click the gas usage amount screen's  button.
  - The Widget setting screen is displayed.

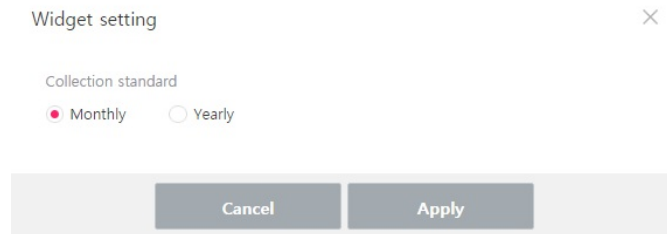

3. Select the collection standard(**Monthly/Yearly**).
4. When selection is completed, click **[Apply]** button.

## Total energy usage amount Widget

You can select the display and collection standard for the total energy usage amount.

1. In the left menu tab, click **[Dashboard] > [Energy]** menu.
  - The energy screen is displayed.
2. Click the total energy usage amount screen's  button.
  - The Widget setting screen is displayed.

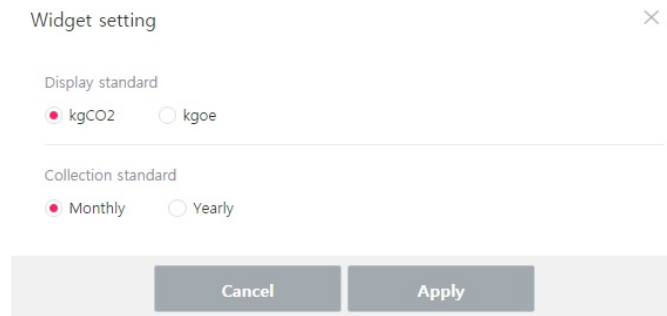

Widget setting ×

Display standard

kgCO2     kgoe

---

Collection standard

Monthly     Yearly

Cancel Apply

3. Select the display standard(**kgCO<sub>2</sub>/kgoe**) and the collection standard(**Monthly/Yearly**).
4. When selection is completed, click **[Apply]** button.



## Device Control

It describes the method to control the device and to monitor the device status.

### [Screen and Icon]

- Screen Structure and Function
- Device Icon

### [Control Window]

- Control of Each Device
- Device Information

### [Control/Monitoring]

- Control
- Monitoring

### [Drawing]

- Edit Drawing
- Delete Drawing

## Screen Structure and Function

1. In the left menu tab, click **[Control] > [Device control]** menu.

- The device control screen is displayed.

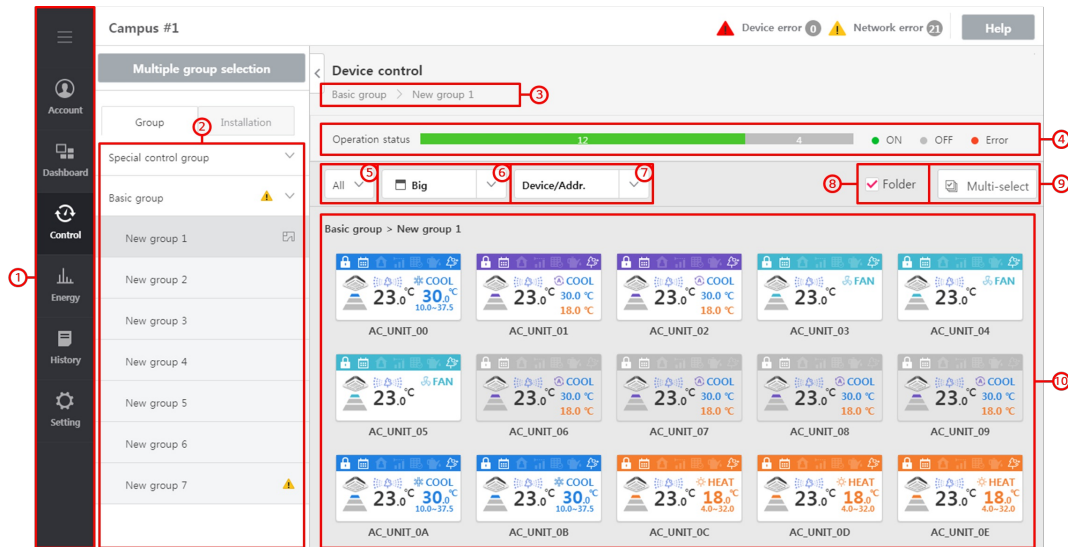

No.	Category	Contents
①	Main Menu	Main Menu Tab
②	Group List	Check control group
③	Group Information	Group name and group location
④	Operation status	Check the devices' current operation status (ON/OFF/Error)
⑤	Filtering	Device category and device status filtering
⑥	Viewing method	Select viewing method of device icon <ul style="list-style-type: none"> <li>☐ : Big</li> <li>■ : Small</li> <li>☰ : List</li> <li>📐 : Drawing</li> </ul>
⑦	Sorting device	Select the sorting method of the device <ul style="list-style-type: none"> <li>• Name</li> <li>• Device/Name</li> <li>• Device/Addr.</li> <li>• Operation</li> </ul>
⑧	View folder	Check the lower level group category of the current group when it is checked
⑨	Multi-select	Select multiple devices when it is clicked
⑩	Device section	Check the information of the devices set in the group

## Management/installation group

1. Group

- management group set for convenience

2. Installation

- Provides the information of actually connected device

## Device Icon





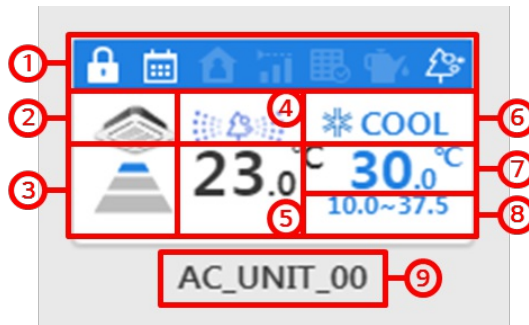

You can check important information of individual devices with icon.

### 1. Big icon



No.	Category	Contents
①	Device status indicating icon	Lock status, schedule, occupied, peak control, filter replacement, oil alarm, air cleaning
②	Device Icon	Check device icon
③	Fan speed	Check device's Fan speed
④	Fine dust status	Check fine dust status Blue (good), Green (normal), Orange (bad), Red (very bad)
⑤	Current temperature	Check current temperature
⑥	Mode	Check mode
⑦	Set temperature	Check set temperature
⑧	Set temp range	Check upper limit/lower limit temperature
⑨	Device name	Check device name

#### Device status indicating icon

Icon	Contents
	Lock
	Schedule
	Occupied
	Peak control
	Filter replacement
	Oil alarm
	Air cleaning

### 2. Small icon

- Check device icon/operation/mode/device name

### 3. View list

- indication of attribute of the device in the group (device name, operation status, operation mode, current temperature, set temperature, error code, ACP address, outdoor unit address, device address, etc.).

When a devices selected in the device section, control window is created in the right side as in the following screen. You can control the selected device through the control window.

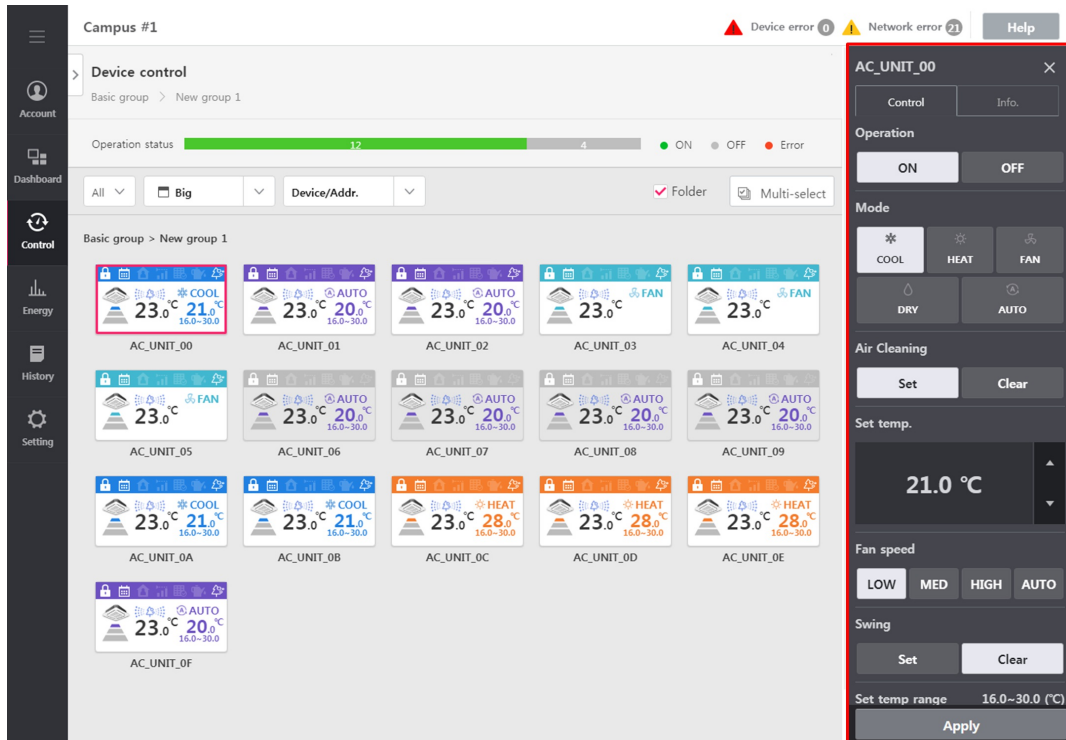

## Note

- The detail control boundary for each device may be different from the actual device, so make sure to refer to the corresponding device's manual.
- Chiller interface is an optional function, and you need to separately purchase the option for chiller interface.
- ACS I/O devices may have different control tool name, unit, upper limit, lower limit, etc. according to the setting.

## Control of Each Device

- ➔ Outdoor Unit
- ➔ IDU
  - IDU (2Set)
- ➔ HRV
- ➔ DXHRV
- ➔ AWHP
- ➔ AHU
- ➔ Scroll chiller
- ➔ Screw chiller
- ➔ Turbo chiller
- ➔ Absorption Chiller
- ➔ DOKIT
- ➔ DO
- ➔ AO

**Outdoor Unit**

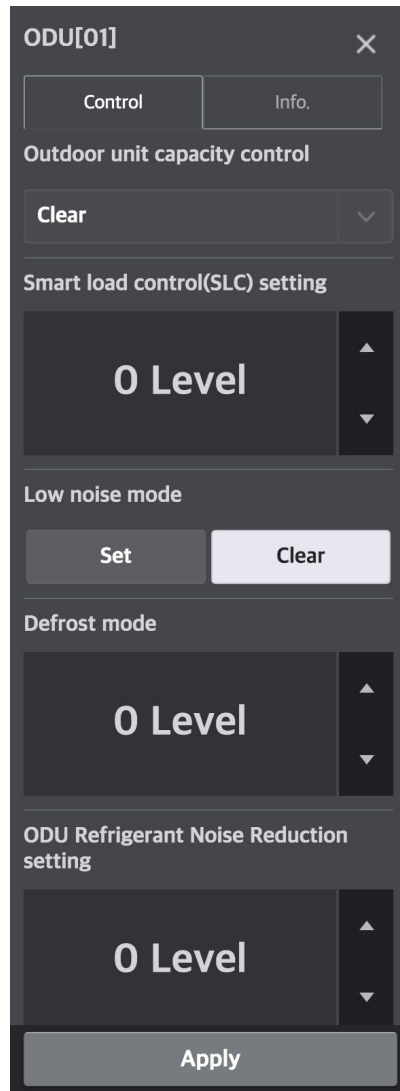

Category	Contents
Outdoor unit capacity control	<ul style="list-style-type: none"> <li>Press [▼] button to set operation rate (%)</li> </ul>
Smart load control function	<ul style="list-style-type: none"> <li>Press [▲]/[▼] button to set smart load control stage (0stage, 1stage, 2stage, 3stage, 4stage)</li> </ul>
Low noise operation	<ul style="list-style-type: none"> <li>[Set/Clear] button: outdoor unit low noise operation Set/Clear</li> </ul>
Defrost mode	<ul style="list-style-type: none"> <li>Press [▲]/[▼] button to set defrost mode stage (0stage, 1stage, 2stage, 3stage)</li> </ul>
ODU Refrigerant Noise Reduction setting	<ul style="list-style-type: none"> <li>Press [▲]/[▼] button to set outdoor unit refrigerant noise reduction stage (0stage, 1stage, 2stage)</li> </ul>

**Note**

In the central controller, if 'outdoor unit low noise operation' is used, in the installed indoor unit's remote controller, you need to set [Installer setting] > [Low noise mode] to 'ODU'. (Default value 'ODU')



Category	Contents
Operation	<ul style="list-style-type: none"> <li>• <b>[ON]</b> button: starts the device operation</li> <li>• <b>[OFF]</b> button: Stops the device operation</li> </ul>
Mode	<ul style="list-style-type: none"> <li>• <b>[COOL]</b> button: Switches to cooling mode</li> <li>• <b>[HEAT]</b> button: Switches to heating mode</li> <li>• <b>[FAN]</b> button: Air purification operation. When FAN is selected, set temperature is not applied to the device</li> <li>• <b>[DRY]</b> button: Removes moisture during rainy season or when humidity is high. When DRY is selected, set temperature is not applied to the device</li> <li>• <b>[AUTO]</b> button: Switches to automatic mode</li> </ul>
Air cleaning	<p>Air cleaning control only for air cleaning function supporting indoor unit</p> <ul style="list-style-type: none"> <li>• Air cleaning single operation <ol style="list-style-type: none"> <li>1) In indoor unit stop state, in case of air cleaning <b>[Set]</b>, air cleaning single operation with wind only (automatic wind) (During air cleaning single operation, mode lock and wind amount lock are not checked)</li> <li>2) During air cleaning single operation, in case of operation <b>[OFF]</b> or air cleaning <b>[Clear]</b>, air cleaning is cancelled to previous mode and previous wind amount (But, in case of mode or wind amount control together, control is done with controlled mode and wind amount)</li> </ol> </li> <li>• Air cleaning additional operation <ol style="list-style-type: none"> <li>1) In indoor unit stop state, in case of operation status <b>[ON]</b> and air cleaning <b>[Set]</b>, in current mode, air cleaning additional operation</li> <li>2) In indoor unit operation state, in case of air cleaning <b>[Set]</b>, in current mode, air cleaning additional operation</li> <li>3) During air cleaning additional operation, in case of operation <b>[OFF]</b>, operation stops</li> <li>4) During air cleaning additional operation, in case of air cleaning <b>[Clear]</b>, air cleaning is cancelled</li> </ol> </li> </ul>

Set temperature	Press <b>[▲]/[▼]</b> button to set the desired temperature
Fan speed	Wind strength setting <ul style="list-style-type: none"> <li>• <b>[LOW]</b> button: Set the fan speed to slow</li> <li>• <b>[MED]</b> button: Set the fan speed to normal</li> <li>• <b>[HIGH]</b> button: Set the fan speed to fast</li> <li>• <b>[AUTO]</b> button: <b>[LOW]-[MED]-[HIGH]</b> automatic switching</li> </ul>
Swing	<ul style="list-style-type: none"> <li>• <b>[Set/Clear]</b> button: Set/Clear the Swing function</li> </ul>
Set temp range	When user set the desired temperature individually, the desired temperature outside the designated temperature boundary cannot be set
Human detection mode - ON/OFF power saving	Only for human detection mode - supporting indoor unit, human detection mode - control <ul style="list-style-type: none"> <li>• <b>[Set/Clear]</b> button: human detection mode - ON/OFF power saving Set/Clear</li> </ul>
Human detection mode - Temperature power saving	Only for human detection mode - supporting indoor unit, human detection mode - control <ul style="list-style-type: none"> <li>• <b>[Set/Clear]</b> button: human detection mode - temperature power saving Set/Clear</li> </ul>
Human detection mode - Unoccupied time setting(minute)	Only for human detection mode - supporting indoor unit, human detection mode - control Set empty decision time to 5, 10, 15, 30, 60, or 90 min.
Human detection mode - Direct wind	Only for human detection mode - supporting indoor unit, human detection mode - control <ul style="list-style-type: none"> <li>• <b>[Set/Clear]</b> button: human detection mode - direct wind Set/Clear</li> </ul>
Human detection mode - Indirect wind	Only for human detection mode - supporting indoor unit, human detection mode - control <ul style="list-style-type: none"> <li>• <b>[Set/Clear]</b> button: human detection mode - indirect wind Set/Clear</li> </ul>
Comfortable Power Saving	<ul style="list-style-type: none"> <li>• <b>[Set/Clear]</b> button: Comfortable Power Saving function Set/Clear</li> <li>• You can press <b>[▲]/[▼]</b> button to set stage</li> </ul> Only when indoor unit is in cooling operation, Comfortable Power Saving control is possible
Filter replacement alarm	<ul style="list-style-type: none"> <li>• <b>[Clear]</b> button: in case of filter replacement alarm, it cancels filter replacement alarm</li> </ul>
HardLock	<ul style="list-style-type: none"> <li>• <b>[Set/Clear]</b> button: Set/clear HardLock so that user cannot control any function with individual remote controller</li> </ul>
Mode lock	<ul style="list-style-type: none"> <li>• <b>[Set/Clear]</b> button: Set/clear lock so that user cannot control mode setting with individual remote controller</li> </ul>
Fan lock	<ul style="list-style-type: none"> <li>• <b>[Set/Clear]</b> button: Set/clear lock so that user cannot control Fan speed setting with individual remote controller</li> </ul>
TempLock	<ul style="list-style-type: none"> <li>• <b>[Set/Clear]</b> button: Set/clear lock so that user cannot control temperature setting with individual remote controller</li> </ul>
Auto change over(Occupied)	It is a function to automatically switch to cooling operation if indoor temperature exceeds upper limit temperature, to heating operation if it is less than lower limit temperature, and to wind only operation if it is between upper limit temperature and lower limit temperature (supported only in outdoor unit with both cooling/heating) <ul style="list-style-type: none"> <li>• <b>[Set/Clear]</b> button: Set/clear Auto change over(Occupied)</li> </ul>
Lower /Upper temp.	Auto change over(Occupied)'s lower limit temperature and upper limit temperature setting
Auto change over(Occupied) Fan speed	Select the Fan speed value to set in the indoor unit during Auto change over(Occupied) operation <ul style="list-style-type: none"> <li>• <b>[LOW]</b> button: Set the fan speed to slow</li> <li>• <b>[MED]</b> button: Set the fan speed to normal</li> <li>• <b>[HIGH]</b> button: Set the fan speed to fast</li> <li>• <b>[AUTO]</b> button: <b>[LOW]-[MED]-[HIGH]</b> automatic switching</li> </ul>
Setback(UnOccupied)	Function to maintain the temperature of the space where the device is installed in certain boundary (Only supported by cooling/heating simultaneous type outdoor unit) <ul style="list-style-type: none"> <li>• <b>[Set/Clear]</b> button: Set/clear the Setback(UnOccupied)</li> </ul>
Cool start	Press <b>[▲]/[▼]</b> button to set the cooling operation start temperature(21°C~40°C)
Heat start	Press <b>[▲]/[▼]</b> button to set the heating operation start temperature(1°C~20°C)

## IDU (2Set)

When 2Set function supporting outdoor unit/indoor unit/remote controller are used and in **[Setting] > [Installing]**, if ACP's 2Set automatic mode is selected as **IDU**, indoor unit 2Set control window is generated on the right side as in the following screen.



Category	Contents
Operation	<ul style="list-style-type: none"> <li>• <b>[ON]</b> button: starts the device operation</li> <li>• <b>[OFF]</b> button: Stops the device operation</li> </ul>
Mode	<ul style="list-style-type: none"> <li>• <b>[COOL]</b> button: Switches to cooling mode</li> <li>• <b>[HEAT]</b> button: Switches to heating mode</li> <li>• <b>[FAN]</b> button: Air purification operation. When FAN is selected, set temperature is not applied to the device</li> <li>• <b>[DRY]</b> button: Removes moisture during rainy season or when humidity is high. When DRY is selected, set temperature is not applied to the device</li> <li>• <b>[AUTO]</b> button: Switches to automatic mode</li> </ul>
Air cleaning	<p>Air cleaning control only for air cleaning function supporting indoor unit</p> <ul style="list-style-type: none"> <li>• Air cleaning single operation                             <ol style="list-style-type: none"> <li>1) In indoor unit stop state, in case of air cleaning <b>[Set]</b>, air cleaning single operation with wind only (automatic wind) (During air cleaning single operation, mode lock and wind amount lock are not checked)</li> <li>2) During air cleaning single operation, in case of operation <b>[OFF]</b> or air cleaning <b>[Clear]</b>, air cleaning is cancelled to previous mode and previous wind amount (But, in case of mode or wind amount control together, control is done with controlled mode and wind amount)</li> </ol> </li> <li>• Air cleaning additional operation                             <ol style="list-style-type: none"> <li>1) In indoor unit stop state, in case of operation status <b>[ON]</b> and air cleaning <b>[Set]</b>, in current mode, air cleaning additional operation</li> <li>2) In indoor unit operation state, in case of air cleaning <b>[Set]</b>, in current mode, air cleaning additional operation</li> <li>3) During air cleaning additional operation, in case of operation <b>[OFF]</b>, operation stops</li> </ol> </li> </ul>

	4) During air cleaning additional operation, in case of air cleaning <b>[Clear]</b> , air cleaning is cancelled
Occupancy	Function to set the space with the corresponding indoor unit as occupied or empty <ul style="list-style-type: none"> <li>• <b>[Occupied]</b> button: occupied setting</li> <li>• <b>[Unoccupied]</b> button: empty setting</li> </ul>
Cooling set temperature	Press <b>[▲]/[▼]</b> button to set cooling set temperature
Heating setting temperature	Press <b>[▲]/[▼]</b> button to set heating set temperature
Cooling lower limit/upper limit temperature	Cooling lower limit temperature and upper limit temperature setting
Heating lower limit/upper limit temperature	Heating lower limit temperature and upper limit temperature setting
Fan speed	Wind strength setting <ul style="list-style-type: none"> <li>• <b>[LOW]</b> button: Set the fan speed to slow</li> <li>• <b>[MED]</b> button: Set the fan speed to normal</li> <li>• <b>[HIGH]</b> button: Set the fan speed to fast</li> <li>• <b>[AUTO]</b> button: <b>[LOW]-[MED]-[HIGH]</b> automatic switching</li> </ul>
Swing	<ul style="list-style-type: none"> <li>• <b>[Set/Clear]</b> button: Set/Clear the Swing function</li> </ul>
Human detection mode - ON/OFF power saving	Only for human detection mode - supporting indoor unit, human detection mode - control <ul style="list-style-type: none"> <li>• <b>[Set/Clear]</b> button: human detection mode - ON/OFF power saving Set/Clear</li> </ul>
Human detection mode - Temperature power saving	Only for human detection mode - supporting indoor unit, human detection mode - control <ul style="list-style-type: none"> <li>• <b>[Set/Clear]</b> button: human detection mode - temperature power saving Set/Clear</li> </ul>
Human detection mode - Unoccupied time setting(minute)	Only for human detection mode - supporting indoor unit, human detection mode - control Set empty decision time to 5, 10, 15, 30, 60, or 90 min.
Human detection mode - Direct wind	Only for human detection mode - supporting indoor unit, human detection mode - control <ul style="list-style-type: none"> <li>• <b>[Set/Clear]</b> button: human detection mode - direct wind Set/Clear</li> </ul>
Human detection mode - Indirect wind	Only for human detection mode - supporting indoor unit, human detection mode - control <ul style="list-style-type: none"> <li>• <b>[Set/Clear]</b> button: human detection mode - indirect wind Set/Clear</li> </ul>
Comfortable Power Saving	<ul style="list-style-type: none"> <li>• <b>[Set/Clear]</b> button: Comfortable Power Saving function Set/Clear</li> <li>• You can press <b>[▲]/[▼]</b> button to set stage</li> </ul> <p>Only when indoor unit is in cooling operation, Comfortable Power Saving control is possible</p>
Filter replacement alarm	<ul style="list-style-type: none"> <li>• <b>[Clear]</b> button: in case of filter replacement alarm, it cancels filter replacement alarm</li> </ul>
HardLock	<ul style="list-style-type: none"> <li>• <b>[Set/Clear]</b> button: Set/clear HardLock so that user cannot control any function with individual remote controller</li> </ul>
Mode lock	<ul style="list-style-type: none"> <li>• <b>[Set/Clear]</b> button: Set/clear lock so that user cannot control mode setting with individual remote controller</li> </ul>
Fan lock	<ul style="list-style-type: none"> <li>• <b>[Set/Clear]</b> button: Set/clear lock so that user cannot control Fan speed setting with individual remote controller</li> </ul>
TempLock	<ul style="list-style-type: none"> <li>• <b>[Set/Clear]</b> button: Set/clear lock so that user cannot control temperature setting with individual remote controller</li> </ul>

## Note

### 2set automatic mode

- Only with 2Set automatic mode supporting indoor/outdoor air, the corresponding function can be used. (For whether each device supports 2Set, please refer to the manual of the corresponding device.)
- Override is a function that can be set from remote controller. For override function related contents, please refer to remote controller manual.
- In 2Set automatic mode, along with Auto icon, product's actual operation mode (cooling, heating) status is displayed.

### Occupancy

- If occupancy sensor is interlinked to indoor unit, setting from the central control has priority over the corresponding occupancy sensor. For occupancy sensor related contents, please refer to indoor unit or Dry Contact manual.
- When occupied setting is changed, automatically set cooling set temperature and heating set temperature are the most recently run schedule's cooling set temperature and heating set temperature, and if there is no previously run schedule, it is set to default value.

#### (Example)

09:00 - 12:00: occupied / cooling set temperature 27°C / heating set temperature 18°C

12:00 - 13:00: occupied / cooling set temperature 29°C / heating set temperature 16°C

13:00 - 15:00: occupied / cooling set temperature 26°C / heating set temperature 19°C

**If it is empty without schedule after 15:00, cooling set temperature is 29°C and heating set temperature is 16°C, and if it is occupied, cooling set temperature becomes 26°C and heating set temperature becomes 19°C.**



HRV

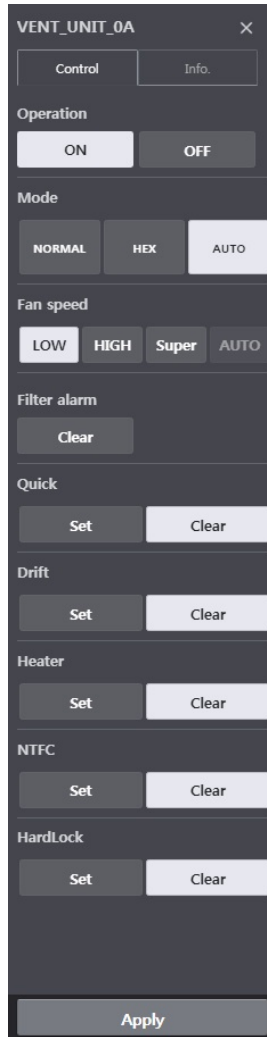

Category	Contents
Operation	<ul style="list-style-type: none"> <li>• <b>[ON]</b> button: starts the device operation</li> <li>• <b>[OFF]</b> button: Stops the device operation</li> </ul>
Mode	<ul style="list-style-type: none"> <li>• <b>[NORMAL]</b> button: Discharged air ventilates without going trough the electric heat exchanger</li> <li>• <b>[HEX]</b> button: Both air supply/discharge ventilates through the electric heat exchanger</li> <li>• <b>[AUTO]</b> button: Switches to four seasons mode</li> </ul>
Fan speed	<p>Wind strength setting</p> <ul style="list-style-type: none"> <li>• <b>[LOW]</b> button: Set the fan speed to slow</li> <li>• <b>[HIGH]</b> button: Set the fan speed to fast</li> <li>• <b>[SUPER]</b> button: Set the fan speed to Max. speed</li> <li>• <b>[AUTO]</b> button: <b>[LOW]-[HIGH]-[SUPER]</b> automatic switching <ul style="list-style-type: none"> <li>- User setting is impossible</li> <li>- When Drift/Quick is set, <b>[AUTO]</b> Fan speed is selected</li> <li>- When Drift/Quick is cleared, <b>[HIGH]</b> Fan speed is selected</li> <li>- During <b>[AUTO]</b> operation, when <b>[LOW]/[HIGH]/[SUPER]</b> is selected, Drift/Quick function in operation is cleared</li> </ul> </li> </ul>
Filter replacement alarm	<ul style="list-style-type: none"> <li>• <b>[Clear]</b> button: in case of filter replacement alarm, it cancels filter replacement alarm</li> </ul>
Additional function	<ul style="list-style-type: none"> <li>• Quick <b>[Set/Clear]</b> button: Set/clear Quick function (When Quick function is selected, Drift function is cleared)</li> <li>• Drift <b>[Set/Clear]</b> button: Set/clear Drift function (When Drift function is selected, Quick function is cleared)</li> <li>• Heater <b>[Set/Clear]</b> button: Set/clear heater function</li> </ul>
Midnight air cooling(NTFC)	<ul style="list-style-type: none"> <li>• <b>[Set/Clear]</b> button: Set/Clear Midnight air cooling(NTFC) function that can outdoor unit cooling when outdoor temperature is lower than the base temperature at night time</li> </ul>
HardLock	<ul style="list-style-type: none"> <li>• <b>[Set/Clear]</b> button: Set/clear HardLock so that user cannot control any function with individual remote controller</li> </ul>

**DXHRV**



Category	Contents
Operation	<ul style="list-style-type: none"> <li>• <b>[ON]</b> button: starts the device operation</li> <li>• <b>[OFF]</b> button: Stops the device operation</li> </ul>
Mode	<ul style="list-style-type: none"> <li>• <b>[NORMAL]</b> button: Discharged air ventilates without going through the electric heat exchanger</li> <li>• <b>[HEX]</b> button: Both air supply/discharge ventilates through the electric heat exchanger</li> <li>• <b>[AUTO]</b> button: Switches to four seasons mode</li> </ul>
Set temperature	Press <b>[▲]</b> / <b>[▼]</b> button to set the desired temperature
Fan speed	Wind strength setting <ul style="list-style-type: none"> <li>• <b>[LOW]</b> button: Set the fan speed to slow</li> <li>• <b>[HIGH]</b> button: Set the fan speed to fast</li> <li>• <b>[SUPER]</b> button: Set the fan speed to Max. speed</li> <li>• <b>[AUTO]</b> button: <b>[LOW]-[HIGH]-[SUPER]</b> automatic switching                             <ul style="list-style-type: none"> <li>- User setting is impossible</li> <li>- When Drift/Quick is set, <b>[AUTO]</b> Fan speed is selected</li> <li>- When Drift/Quick is cleared, <b>[HIGH]</b> Fan speed is selected</li> <li>- During <b>[AUTO]</b> operation, when <b>[LOW]/[HIGH]/[SUPER]</b> is selected, Drift/Quick function in operation is cleared</li> </ul> </li> </ul>
Air conditioner	<ul style="list-style-type: none"> <li>• <b>[COOL]</b> button: Operates the direct cooling type ventilation in cooling mode</li> <li>• <b>[AUTO]</b> button: Automatically operates the direct cooling type ventilation by deciding the indoor condition</li> <li>• <b>[HEAT]</b> button: Operates the direct cooling type ventilation as heating mode</li> <li>• <b>[OFF]</b> button: Stops the air conditioner of the direct cooling type ventilation</li> </ul>
Set temp range	When user set the desired temperature individually, the desired temperature outside the designated temperature boundary cannot be set
Filter replacement alarm	<ul style="list-style-type: none"> <li>• <b>[Clear]</b> button: in case of filter replacement alarm, it cancels filter replacement alarm</li> </ul>

Additional function	<ul style="list-style-type: none"> <li>• Quick <b>[Set/Clear]</b> button: Set/clear Quick function (When Quick function is selected, Drift function is cleared)</li> <li>• Drift <b>[Set/Clear]</b> button: Set/clear Drift function (When Drift function is selected, Quick function is cleared)</li> <li>• Heater <b>[Set/Clear]</b> button: Set/clear heater function</li> <li>• Humidify <b>[Set]</b> button: Set Humidify function (only for air conditioner heating mode)</li> </ul>
Midnight air cooling(NTFC)	<ul style="list-style-type: none"> <li>• <b>[Set/Clear]</b> button: Set/Clear Midnight air cooling(NTFC) function that can outdoor unit cooling when outdoor temperature is lower than the base temperature at night time</li> </ul>
HardLock	<ul style="list-style-type: none"> <li>• <b>[Set/Clear]</b> button: Set/clear HardLock so that user cannot control any function with individual remote controller</li> </ul>
Mode lock	<ul style="list-style-type: none"> <li>• <b>[Set/Clear]</b> button: Set/clear lock so that user cannot control mode setting with individual remote controller</li> </ul>
Fan lock	<ul style="list-style-type: none"> <li>• <b>[Set/Clear]</b> button: Set/clear lock so that user cannot control Fan speed setting with individual remote controller</li> </ul>
TempLock	<ul style="list-style-type: none"> <li>• <b>[Set/Clear]</b> button: Set/clear lock so that user cannot control temperature setting with individual remote controller</li> </ul>
Midnight air cooling(NTFC) lock	<ul style="list-style-type: none"> <li>• <b>[Set/Clear]</b> button: Set/Clear Midnight air cooling(NTFC) schedule set in the remote controller</li> </ul>

**AWHP**

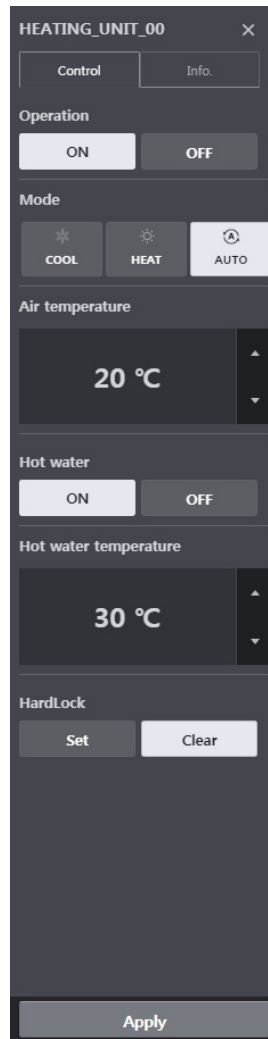

Category	Contents
Operation	<ul style="list-style-type: none"> <li>• <b>[ON]</b> button: starts the device operation</li> <li>• <b>[OFF]</b> button: Stops the device operation</li> </ul>
Mode	<ul style="list-style-type: none"> <li>• <b>[COOL]</b> button: Swtiches to cooling mode</li> <li>• <b>[HEAT]</b> button: Switches to heating mode</li> <li>• <b>[AUTO]</b> button: Switches to automatic mode</li> </ul>
Air/Water in/out temperature	<p>Press <b>[▲]/[▼]</b> button to set Air/Water in/out temperature</p> <p>It is displayed based on the set temperature selected in <b>[Setting]-[Installing]</b></p> <ul style="list-style-type: none"> <li>• When <b>[Water in/out]</b> is selected, it is displayed as water in/out temperature</li> <li>• When <b>[indoor]</b> is selected, it is displayed as air temperature</li> </ul>
Hot water	<ul style="list-style-type: none"> <li>• <b>[ON]</b> button: Starts hot water operation <ul style="list-style-type: none"> <li>- If hot water is operated while the device is in automatic/cooling operation, the corresponding mode and hot water are displayed in the icon of the contents display section</li> <li>- If hot water is operated while the device is stopped, the icon in the contents display section is enabled, and hot water is displayed</li> </ul> </li> <li>• <b>[OFF]</b> button: Stops hot water operation</li> </ul>
Hot water temperature	<p>Press <b>[▲]/[▼]</b> button to set hot water temperature</p>
HardLock	<ul style="list-style-type: none"> <li>• <b>[Set/Clear]</b> button: Set/clear HardLock so that user cannot control any function with individual remote controller</li> </ul>



AHU

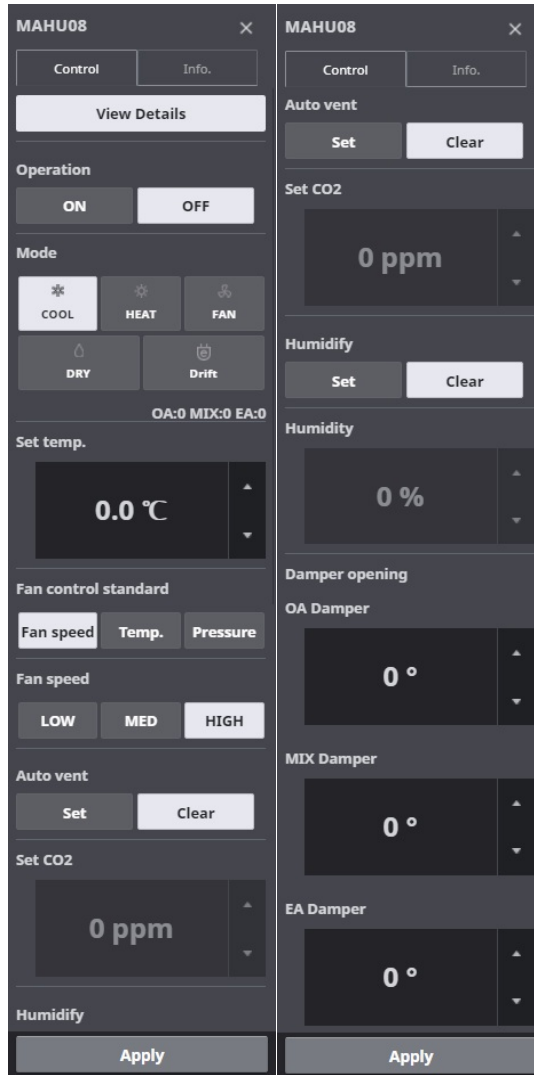

Category	Contents
View Details	Press <b>[View Details]</b> button to check detail information (But, mobile is excluded)
Operation	<ul style="list-style-type: none"> <li>• <b>[ON]</b> button: starts the device operation</li> <li>• <b>[OFF]</b> button: Stops the device operation</li> </ul>
Mode	<ul style="list-style-type: none"> <li>• <b>[COOL]</b> button: Switches to cooling mode</li> <li>• <b>[HEAT]</b> button: Switches to heating mode</li> <li>• <b>[FAN]</b> button: Air purification operation. When FAN is selected, you cannot set the desired temperature</li> <li>• <b>[DRY]</b> button: Removes moisture in rainy season or when humidity is high. When DRY is selected, you cannot set the desired temperature</li> <li>• <b>[Drift]</b> button: Operation to find the operation point with the best ventilation system efficiency to save power consumption. It fluently discharges the contaminated indoor air by having bigger discharger Fan speed than air supply</li> </ul>
Set temperature	Press <b>[▲]/[▼]</b> button to set the temperature
Fan control standard	<ul style="list-style-type: none"> <li>• <b>[Fan speed]</b> button: Controls the fan based on Fan speed status</li> <li>• <b>[Temp]</b> button: Controls the fan based on temperature status</li> <li>• <b>[Pressure]</b> button: Controls the fan based on Pressure status</li> </ul>
Fan speed	It is displayed only when fan control standard is Fan speed <ul style="list-style-type: none"> <li>• <b>[LOW]</b> button: Set the fan speed to slow</li> <li>• <b>[MED]</b> button: Set the fan speed to normal</li> <li>• <b>[HIGH]</b> button: Set the fan speed to fast</li> </ul>
Automatic ventilation	It is displayed only when the additional function's automatic ventilation or automatic ventilation and Humidify are selected during AHU device registration <ul style="list-style-type: none"> <li>• Automatic ventilation <b>[Set/Clear]</b> button: Starts/stops automatic ventilation</li> </ul>

Set CO <sub>2</sub>	It is enabled only when automatic ventilation function is set Press <b>[▲]/[▼]</b> button to set in the unit of 100ppm within 100 ppm ~ 2 000 ppm range
Humidify	It is displayed only when the additional function's Humidify or automatic ventilation and Humidify are selected during AHU device registration <ul style="list-style-type: none"> <li>Humidify <b>[Set/Clear]</b> button: Starts/stops Humidify function</li> </ul>
Humidity	It is enabled only when Humidify function is set Press <b>[▲]/[▼]</b> button to set the target humidity
Damper opening	<ul style="list-style-type: none"> <li>Press <b>[OA Damper]</b> : <b>[▲]/[▼]</b> button to set the outdoor unit air damper opening value in the unit of 1 ° within 0 ° ~ 90 ° range</li> <li>Press <b>[MIX Damper]</b> : <b>[▲]/[▼]</b> button to set the mixer damper opening value in the unit of 1 ° within 0 ° ~ 90 ° range</li> <li>Press <b>[EA Damper]</b> : <b>[▲]/[▼]</b> button to set the air discharge damper opening value in the unit of 1 ° within 0 ° ~ 90 ° range</li> </ul> <p>When you set <b>[Setting]-[system setting]'s Apply damper opening formula</b> as <b>set</b>, it operates as OA Damper = EA Damper, OA Damper = MIX Damper = 90</p>
HardLock	<ul style="list-style-type: none"> <li><b>[Set/Clear]</b> button: Set/clear HardLock so that user cannot control any function with individual remote controller</li> </ul>

## View AHU in detail

In AHU's control screen, you can press **[View Details]** button to check detail information.

The screenshot displays the AHU control interface for 'Campus #1'. At the top, there is a status bar with 'Operation status' (3 ON, 21 OFF, Error) and indicators for 'Device error 0' and 'Network error 21'. A 'Help' button is also present.

The main area features a 3D schematic of the AHU unit with various components labeled:

- EA (Exhaust Air)**: Top left section with a damper set to 0°.
- RA (Return Air)**: Top right section with a damper set to 0°.
- OA (Outdoor Air)**: Bottom left section with a damper set to 0°.
- SA (Supply Air)**: Bottom right section with a damper set to 0°.

Key parameters shown in the schematic include:

- Temperature 30.0°C, Humidity 0%, CO<sub>2</sub> 0ppm (RA)
- Temperature 30.0°C, Humidity 0% (EA)
- Temperature 30.0°C, Humidity 0% (OA)
- SA static pressure 0Pa, Temperature 30.0°C, Humidity 0% (SA)
- Temperature 30.0°C (bottom center)

On the right side, a control panel for 'MAHU\_Fresh' is visible, featuring:

- Buttons for 'Control' and 'Info'.
- A 'View Details' button.
- 'Operation' status: ON (selected) and OFF.
- 'Mode' selection: COOL, HEAT, FAN, DRY, and Drift.
- 'Set temp.' display: 18.0 °C.
- 'Fan control standard' buttons: Fan speed, Temp., and Pressure.
- 'Fan speed' control.
- An 'Apply' button at the bottom.

Scroll chiller

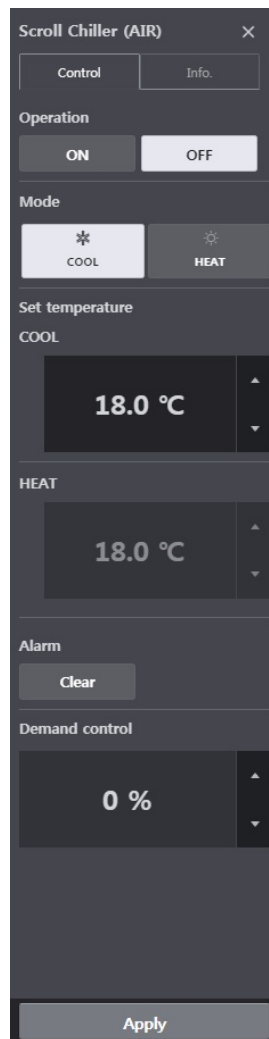

Category	Contents
Operation	<ul style="list-style-type: none"> <li>• <b>[ON]</b> button: starts the device operation</li> <li>• <b>[OFF]</b> button: Stops the device operation</li> </ul>
Mode	(It is displayed only when device supports the corresponding mode) <ul style="list-style-type: none"> <li>• <b>[COOL]</b> button: Switches to cooling mode</li> <li>• <b>[HEAT]</b> button: Switches to heating mode</li> </ul>
Set temperature	Set the load water out temperature for indoor cooling/heating Press <b>[▲]/[▼]</b> button to set the temperature of cooling mode and heating mode
Alarm	<b>[Clear]</b> button: Clears Chiller alarm in case of Chiller alarm
Demand control	Press <b>[▲]/[▼]</b> button to set demand limit ratio

Screw chiller

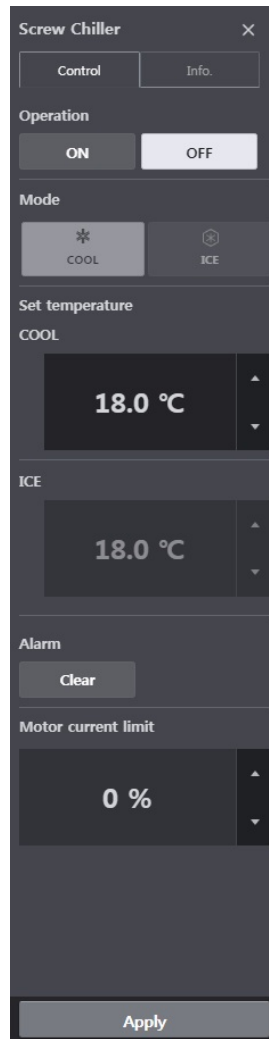

Category	Contents
Operation	<ul style="list-style-type: none"> <li>• <b>[ON]</b> button: starts the device operation</li> <li>• <b>[OFF]</b> button: Stops the device operation</li> </ul>
Mode	Mode control is impossible. Controls monitored operation mode's set temperature
Set temperature	Set the load water out temperature for indoor cooling/ice making Press <b>[▲]/[▼]</b> button to set the temperature of cooling mode and ice making mode
Alarm	<b>[Clear]</b> button: Clears Chiller alarm in case of Chiller alarm
Motor current limit	Press <b>[▲]/[▼]</b> button to set motor current limit ratio

**Turbo chiller**

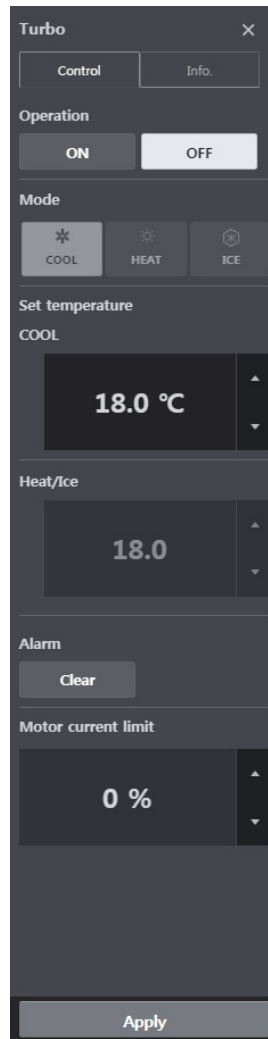

Category	Contents
Operation	<ul style="list-style-type: none"> <li>• <b>[ON]</b> button: starts the device operation</li> <li>• <b>[OFF]</b> button: Stops the device operation</li> </ul>
Mode	Mode control is impossible. Controls monitored operation mode's set temperature
Set temperature	Set the load water out temperature for indoor cooling/heating/ice making Press <b>[▲]/[▼]</b> button to set the temperature of cooling mode and heating/ice making mode
Alarm	<b>[Clear]</b> button: Clears Chiller alarm in case of Chiller alarm
Motor current limit	Press <b>[▲]/[▼]</b> button to set motor current limit ratio

## Absorption Chiller

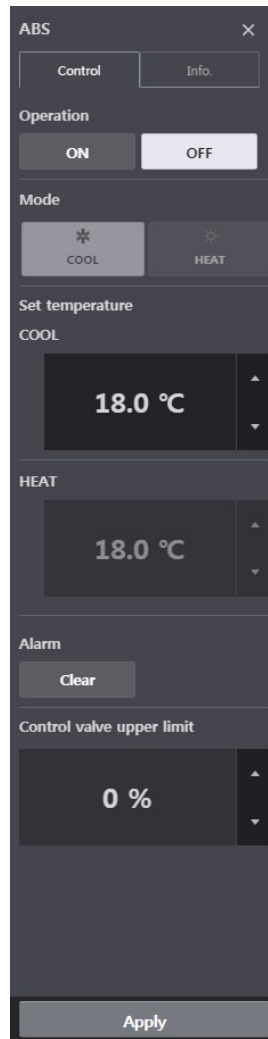

Category	Contents
Operation	<ul style="list-style-type: none"> <li>• <b>[ON]</b> button: starts the device operation</li> <li>• <b>[OFF]</b> button: Stops the device operation</li> </ul>
Mode	Mode control is impossible. Controls monitored operation mode's set temperature
Set temperature	Set the load water out temperature for indoor cooling/heating Press <b>[▲]</b> / <b>[▼]</b> button to set the temperature of cooling mode and heating mode
Alarm	<b>[Clear]</b> button: Clears Chiller alarm in case of Chiller alarm
Control valve upper limit	Press <b>[▲]</b> / <b>[▼]</b> button to set the control valve upper limit ratio

**DOKIT**

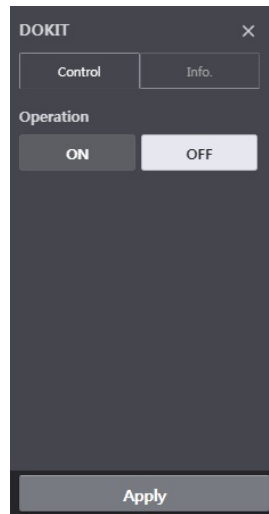

Category	Contents
Operation	<ul style="list-style-type: none"><li>• <b>[ON]</b> button: starts the device operation</li><li>• <b>[OFF]</b> button: Stops the device operation</li></ul>



DO

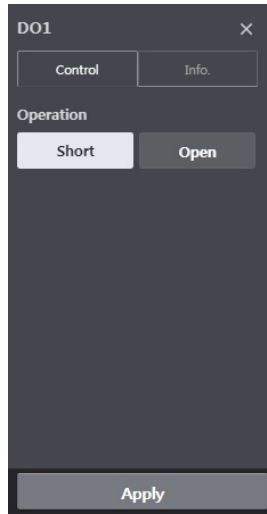

Category	Contents
Operation	<ul style="list-style-type: none"><li>• <b>[Short]</b> button: Short signal output</li><li>• <b>[Open]</b> button: Open signal output</li></ul>



AO



Category	Contents
Temperature	Set temperature value

**Note**

Unit symbol may change according to the usage set during device registration.



## Device Information

When you click device information tab in the device's control screen, you can check the device information.

You can check device's basic information, operation information, schedule information, error information, and today's history.

The image displays five sequential screenshots of the AC\_UNIT\_00 control interface, each showing a different information tab selected. The interface is dark-themed with white text and includes a 'Control' and 'Info.' tab at the top of each screen.

- Basic information:** Shows Name (AC\_UNIT\_00), Address (00), Group (New group 1), ODU (ODU[00]), Model (AC), Capacity (3), ODU model (MULTIV), and ODU capa. (100).
- Operation information:** Shows Operation (ON), Mode (AUTO), Air Cleaning (Set), Current temperature (23.0 °C), Fine dust (PM10) (0µg/m³ (Good)), Ultra fine dust (PM2.5) (0µg/m³ (Good)), Super ultra fine dust (PM1.0) (0µg/m³ (Good)), Occupancy (Unoccupied), Cool set temperature (30.0 °C), Heating set temperature (18.0 °C), and temperature limits for cooling and heating.
- Schedule information (5):** Shows a table with columns 'Time' and 'Description', listing five '10:10 Schedule' entries.
- Error information:** Shows Error (No error) and Error code (0).
- History:** Shows a table with columns 'Time' and 'Contents', listing a single entry: '2018-02-01 10:11 Control Mode: AUTO by Schedule'.

## Control

You can set the registered device to the desired status and control.

1. In the left side menu tab, click **[Control] > [Device control]** menu.
2. In the device list tab section, click the desired tab.

Category	Description
Group	List of group set for convenience
Installation	Provides actually connected device information

3. In the filter section, click the filter button of the device type or status to control.
  - All filter buttons can be selected in multiple.
  - Only the corresponding information are selected and displayed.

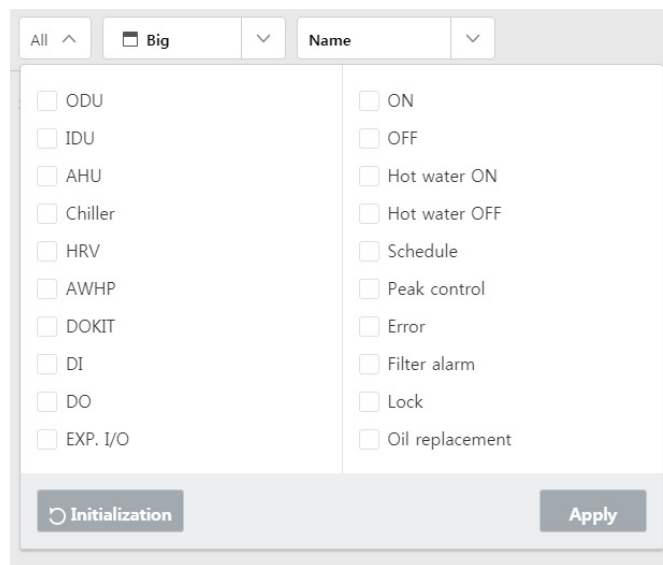

Filter type	Detail category
Device	Outdoor unit, indoor unit, AHU, chiller, ventilation, system boiler, ON/OFF device, DI, DO, Exp.I/O
Status	ON, OFF, Hot water ON, Hot water OFF, Schedule, Peak control, Error, Filter alarm, Lock, Oil replacement

4. In the device section, select the device to control.
  - You can select several devices at once to control. To select all devices in certain group, click **[Multi-select]** button, and click **[Select All]** button. According to the multiple selected device types, the category to control is limited.

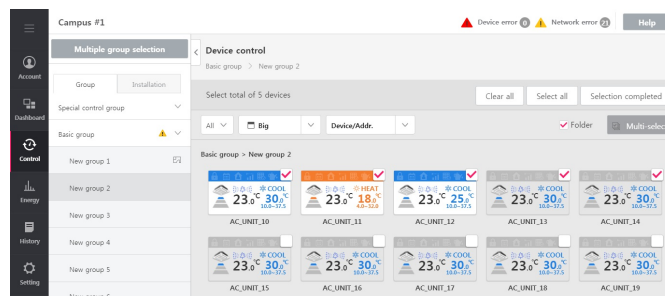

5. In the control window, set the corresponding equipment's control status.
6. When setting is completed, click **[Apply]** button.

## Monitoring

You can check the registered device's control status.

1. In the left side menu tab, click **[Control] > [Device control]** menu.
2. In the device list tab section, click the desired tab.

Category	Description
Group	List of group set for convenience
Installation	Provides actually connected device information

3. In the filter section, click the filter button of the device type or status to check.
  - All filter buttons can be selected in multiple.
  - Only the corresponding information are selected and displayed.

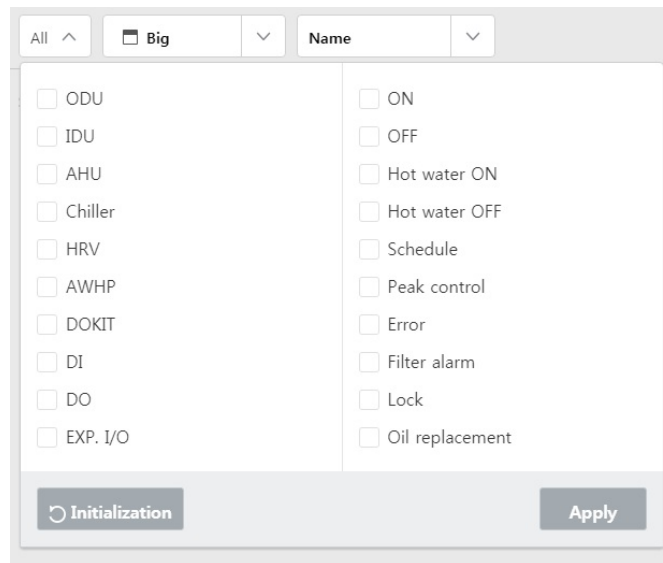

Filter type	Detail category
Device	Outdoor unit, indoor unit, AHU, chiller, ventilation, system boiler, ON/OFF device, DI, DO, Exp.I/O
Status	ON, OFF, Hot water ON, Hot water OFF, Schedule, Peak control, Error, Filter alarm, Lock, Oil replacement

4. In the device section, check the device information.
5. To check the device's detail control status, click the corresponding device icon.
  - The corresponding device's control window is displayed.

## Edit Drawing

When **[Setting] > [System setting]**'s **Use 'Drawing'** is selected as **Set**, you can edit the drawing.

1. In the left side menu tab, click **[Control] > [Device control]** menu.
2. In device group tab area, click **[Group]** tab.
  - When you select **[Installation]** tab, the viewing method's **[Drawing]** is disabled.
3. In the viewing method, click **[View Drawing]**.

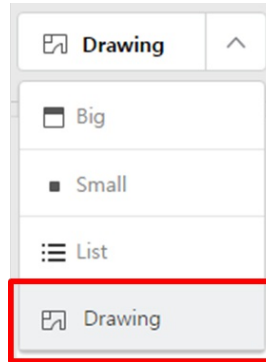

4. Click **[Edit]** button.

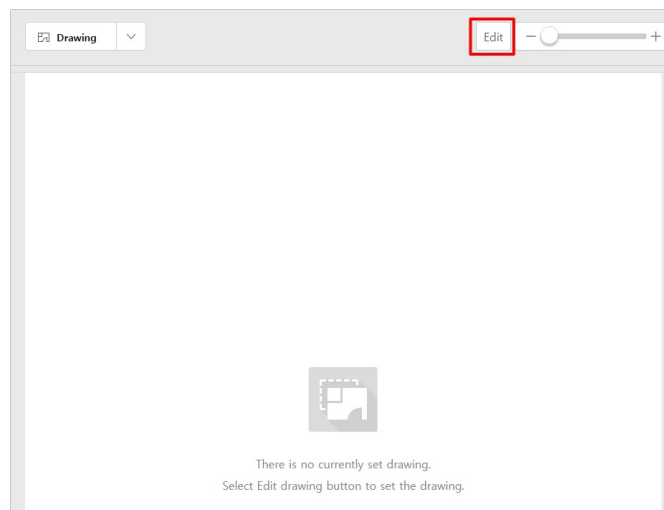

5. When you add or change drawing, click **[Add Drawing]** button.

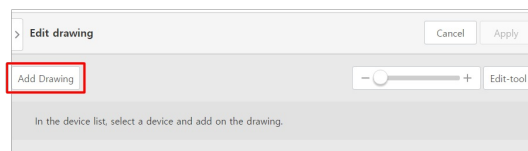

6. When file load window is displayed, select the drawing file to add and click **[Open]** button.
  - The selected drawing is displayed in the Edit drawing screen.

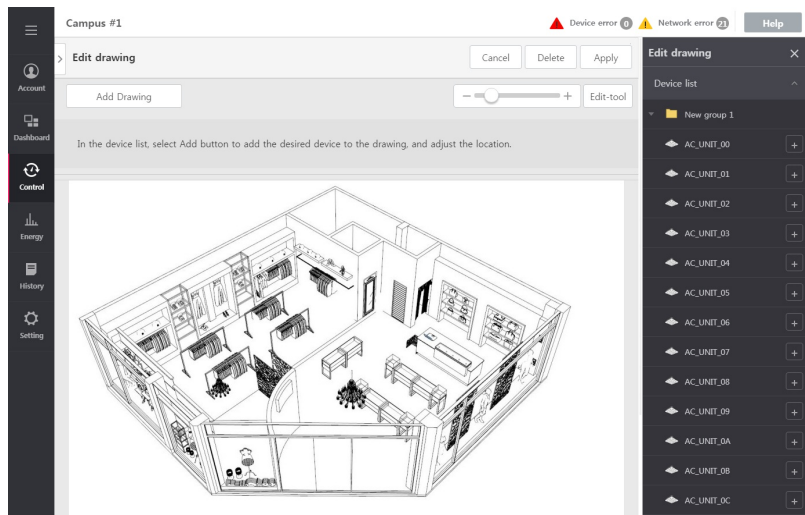



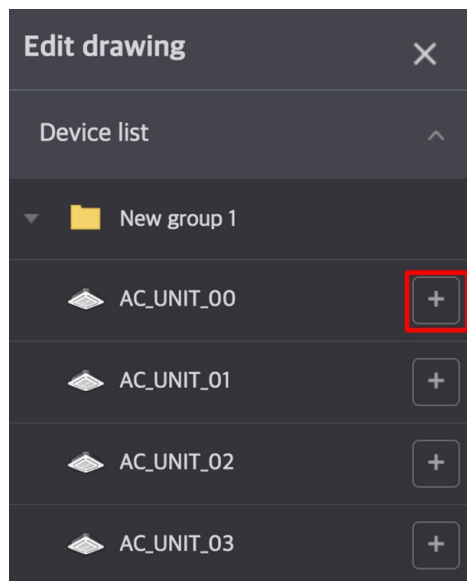



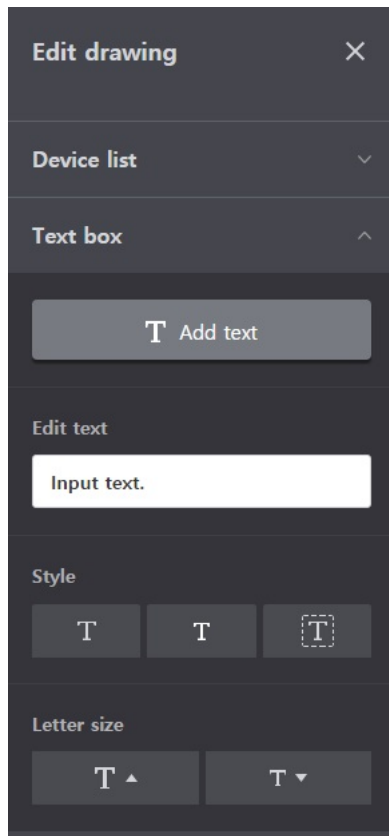

- To add device in the drawing, select the desired device in the device list in the right side Edit drawing window, and click **[+]** button. The device is added in the drawing section.



- To add text or change text in the drawing, use text box.



Category	Description
Add text	Add text box in drawing section
Edit text	Edit text in text box
Style	<ul style="list-style-type: none"> <li> : Normal letter, thick, Italic, underline</li> <li>•  : Display in normal letter</li> <li>•  : Display in thick letter</li> <li>•  : Display in Italic letter</li> <li>•  : Display with underlined letter</li> <li> : Change letter color</li> <li> : Change letter background color</li> </ul>
Letter size	<ul style="list-style-type: none"> <li> : Larger letter</li> <li> : Smaller letter</li> </ul>

9. When setting is completed, click **[Apply]** button.

**Note**

- **Part of drawing image with vertical resolution of 1000px or more may not be displayed, and please use image of adequate resolution according to the display resolution.  
In environment with display resolution of 1920x1080, image of 1478x1000 or less is recommended.**
- **During text add / edit, special symbol (^, ", \) may not be used.**

## Delete Drawing

You can delete the added drawing.

1. In the left side menu tab, click **[Control]** > **[Device control]** menu.
2. In device group tab area, click **[Group]** tab.
3. In the viewing method, click **[View Drawing]**.

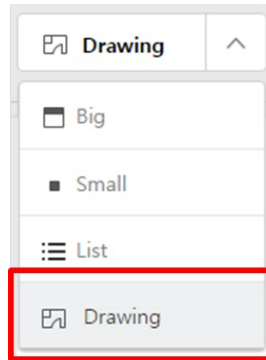

4. Click **[Edit]** button.
  - The Edit drawing screen is displayed.

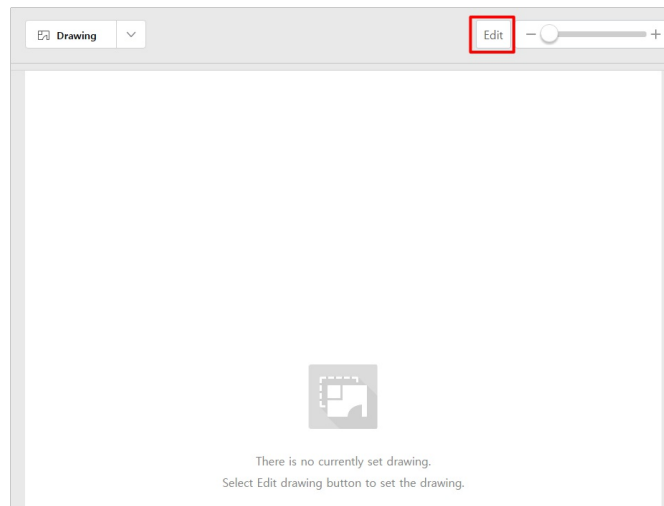

5. Click **[Delete]** button at the top.
  - The drawing is deleted.

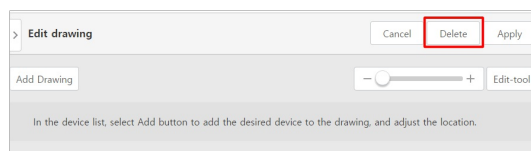



## Schedule Control

Schedule is the function to designate the device operation in advance and let the device perform the operation reserved at certain time. When you use this function, you can efficiently manage the device operation in time unit for excellent energy saving effect.

### [Schedule]

- View entire schedule
- Add Schedule
- Delete schedule
- Copy schedule
- Edit schedule

### [Exception Date]

- Load exception date
- Add exception date
- Delete exception date

### Note

#### Recommended specification

- **Schedule: No. of all events included in entire schedule is 50**
- **If it is set to be over the recommended specification, performance degradation may occur.**

## View entire schedule

You can see the list of schedule in the set period.

You can check whether the set schedule is applied, name, whether to repeat, start date, end date, and device list, and directly **[Set]** or **[Clear]** the desired schedule.

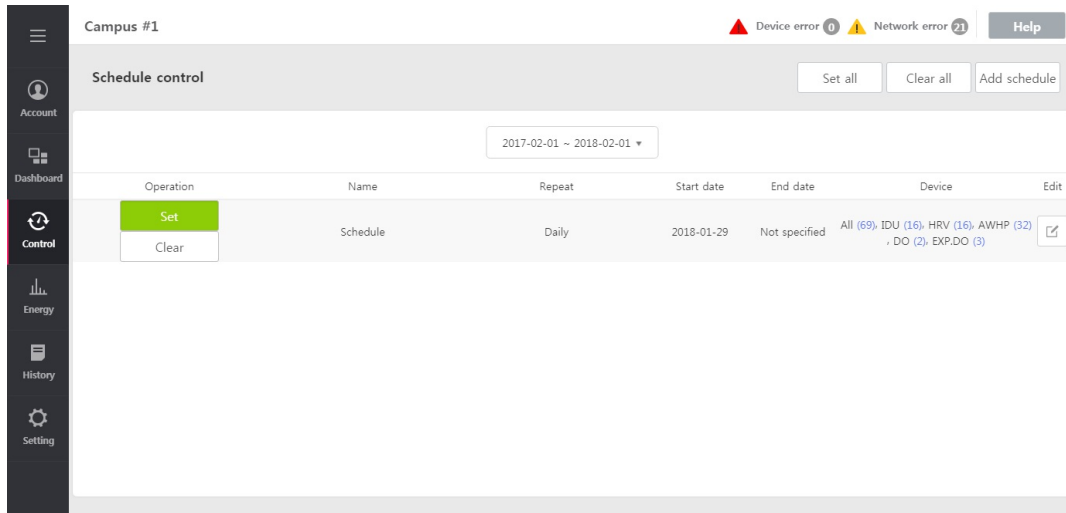

**Campus #1** ▲ Device error 0 ▲ Network error 21 Help

**Schedule control** Set all Clear all Add schedule

2017-02-01 ~ 2018-02-01 ▾

Operation	Name	Repeat	Start date	End date	Device	Edit
<span style="background-color: #90EE90; padding: 2px 5px;">Set</span> <span style="padding: 2px 5px;">Clear</span>	Schedule	Daily	2018-01-29	Not specified	All (69), IDU (16), HRV (16), AWHP (32), DO (2), EXP.DO (3)	

**Control** | Energy | History | Setting

## Add Schedule

You can add schedule category.

1. In the left menu tab, click **[Control] > [Schedule Control]** menu.
  - The schedule control screen is displayed.
2. In the schedule list, click **[Add Schedule]** button.
  - The Add schedule screen is displayed.
3. In the schedule name input field, input the desired schedule name.
4. Set whether to repeat the schedule.

Category	Description
Once	Apply the corresponding schedule only to one day designated in <b>[Period]</b>
Day of week selection	Select the desired day of week, and apply the schedule only to the corresponding day of week from the start date to the end date

5. Set the desired period.
  - When repetition is selected as **[Once]**, select only 1 day
  - When repetition is selected as **[select day of week]**, select start and end date

Category	Description
Start Date	<ul style="list-style-type: none"> <li>• Select the desired start date in mini calendar</li> <li>• Initial start date is selected as today's date</li> </ul>
End date	<ul style="list-style-type: none"> <li>• Select the desired end date in mini calendar</li> <li>• You cannot set the end date before the start date</li> </ul>
End date not specified	<ul style="list-style-type: none"> <li>• Apply the schedule repeatedly without designating the end date</li> </ul>

6. To apply the set exception date, click **[Load]** button.
  - The exception date set in **[Setting]-[system setting]'s schedule exception date setting** is updated and displayed.
7. To apply the new exception date, click **[Add Exception Date]** button to set the exception date name and date to add.
8. In the device setting section, click **[Edit Unit]** button.
  - The Edit Unit window is displayed.

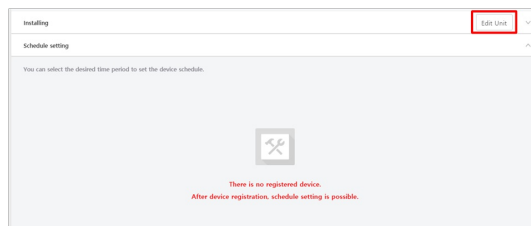

9. In the unregistered device list, click the checkbox of the device to register and click **[◀]** button.
  - To register several groups at once, click the checkbox of the group to register and click **[◀]** button.
  - The selected devices are added to the registered device list.

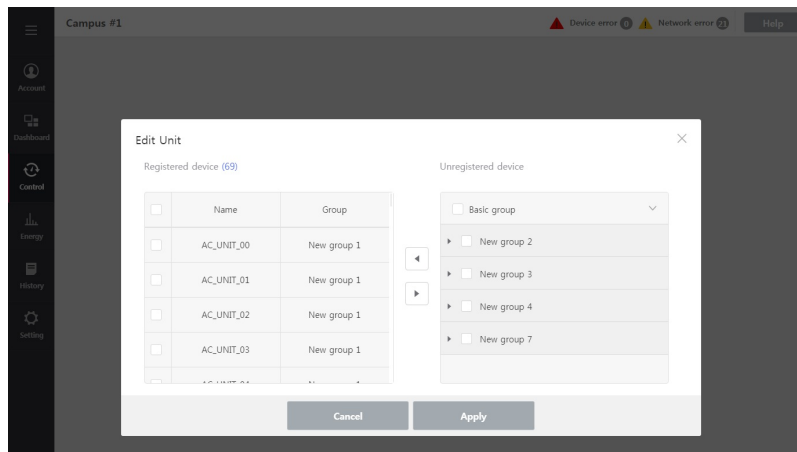

10. When device registration is completed, click **[Apply]** button.

11. To add schedule event, in **Schedule setting**, select device type tab, and click **[Add event]** button or edit button to set control status of the device in the right side control area.

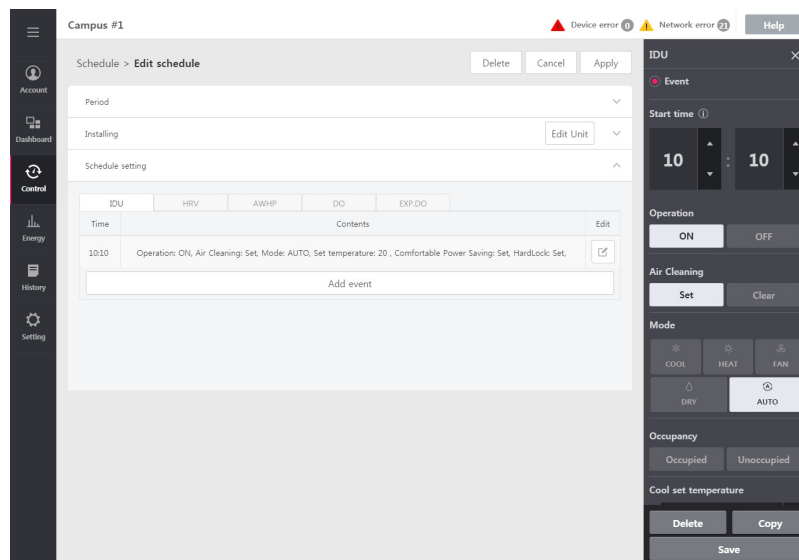

12. When control setting is completed, click **[Save]** button.

13. When all settings are completed, click **[Apply]** button.

## Delete schedule

You can delete already registered schedule.

1. In the left menu tab, click **[Control] > [Schedule Control]** menu.
  - The schedule control screen is displayed.
2. In the schedule list, click the Edit button of the schedule to delete.

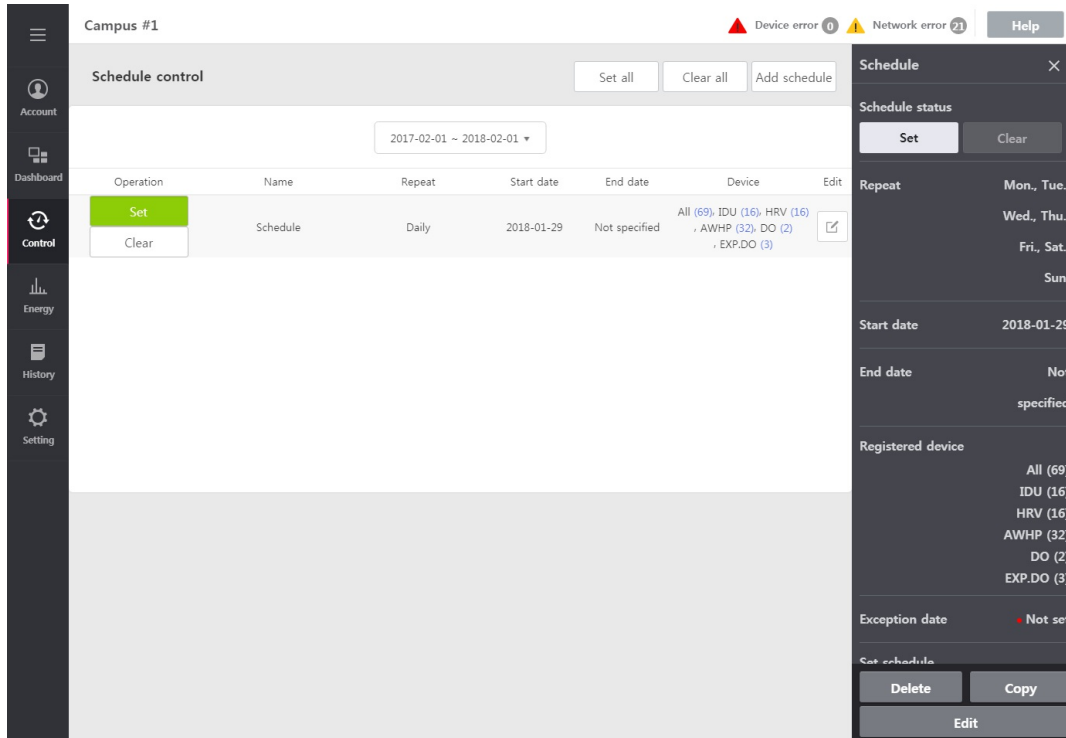

3. In the right side Edit window screen, click **[Delete]** button.
4. When notice popup window is created, click **[Check]** button.

## Copy schedule

You can copy and use registered schedule.

1. In the left menu tab, click [**Control**] > [**Schedule Control**] menu.
  - The schedule control screen is displayed.
2. In schedule list, click edit button of the schedule to copy.

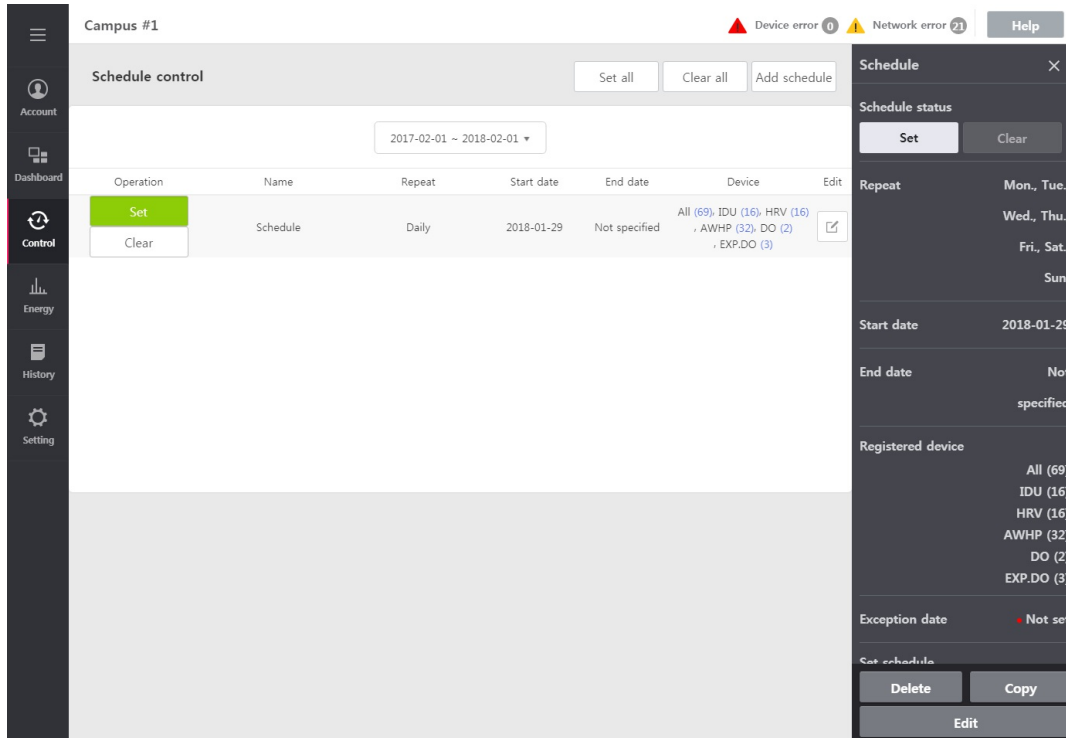

The screenshot shows the 'Schedule control' interface for 'Campus #1'. At the top, there are status indicators for 'Device error' (0) and 'Network error' (21), along with a 'Help' button. Below these are buttons for 'Set all', 'Clear all', and 'Add schedule'. A date range selector shows '2017-02-01 ~ 2018-02-01'. The main table has columns for 'Operation', 'Name', 'Repeat', 'Start date', 'End date', 'Device', and 'Edit'. One row is visible with 'Set' in the 'Operation' column, 'Schedule' in 'Name', 'Daily' in 'Repeat', '2018-01-29' in 'Start date', 'Not specified' in 'End date', and 'All (69), IDU (16), HRV (16), AWHP (32), DO (2), EXP.DO (3)' in 'Device'. An 'Edit' button is in the 'Edit' column. A right-side 'Schedule' edit window is open, showing 'Schedule status' with 'Set' and 'Clear' buttons. The 'Repeat' section shows 'Mon., Tue., Wed., Thu., Fri., Sat., Sun.'. 'Start date' is '2018-01-29' and 'End date' is 'Not specified'. 'Registered device' lists 'All (69), IDU (16), HRV (16), AWHP (32), DO (2), EXP.DO (3)'. 'Exception date' is 'Not set'. At the bottom of the window are 'Delete', 'Copy', and 'Edit' buttons.

3. In the right side edit window screen, click [**Copy**] button.
4. When notice popup window is created, click [**Check**] button.

## Edit schedule

You can change the set contents of the already registered schedule.

1. In the left menu tab, click [**Control**] > [**Schedule Control**] menu.
  - The schedule control screen is displayed.
2. In the schedule list, click Edit button of the schedule to edit.

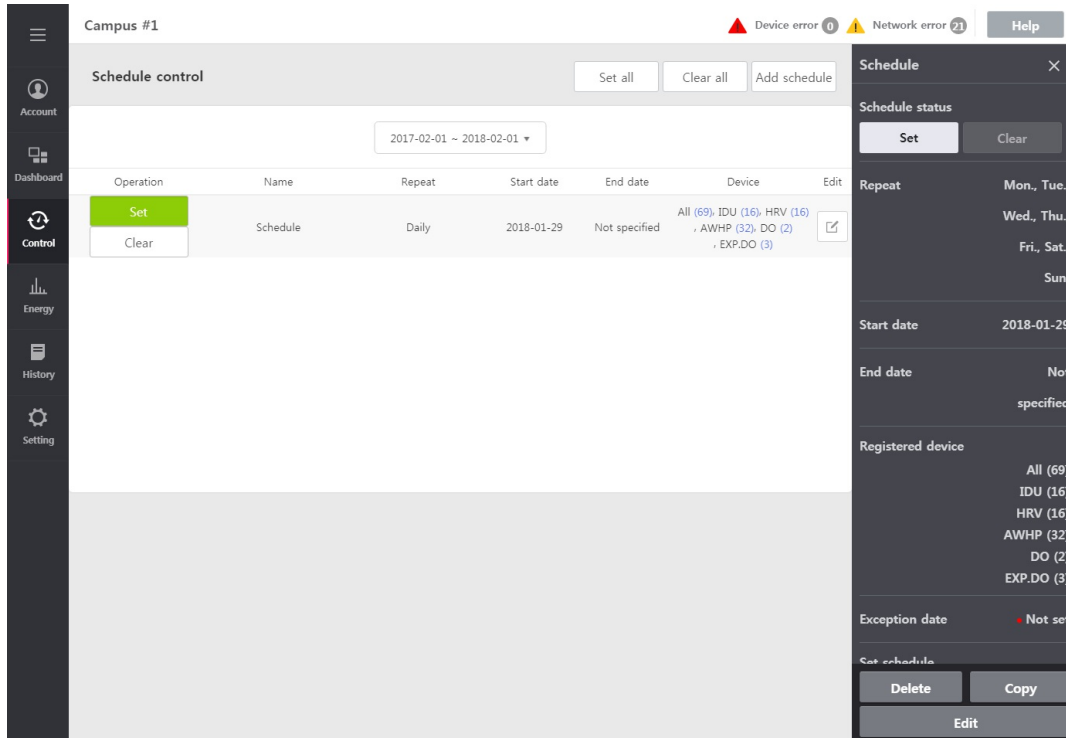

The screenshot displays the 'Schedule control' interface for 'Campus #1'. At the top, there are status indicators for 'Device error' (0) and 'Network error' (21), along with a 'Help' button. The main area shows a table with columns: Operation, Name, Repeat, Start date, End date, Device, and Edit. A single row is visible with 'Set' in the Operation column, 'Schedule' in Name, 'Daily' in Repeat, '2018-01-29' in Start date, 'Not specified' in End date, and 'All (69), IDU (16), HRV (16), AWHP (32), DO (2), EXP.DO (3)' in Device. A right-side edit window is open, showing 'Schedule status' with 'Set' and 'Clear' buttons, 'Repeat' set to 'Mon., Tue., Wed., Thu., Fri., Sat., Sun.', 'Start date' as '2018-01-29', 'End date' as 'Not specified', 'Registered device' list, and 'Exception date' as 'Not set'. At the bottom of the edit window are 'Delete', 'Copy', and 'Edit' buttons.

3. In the right side edit window screen, click [**Edit**] button.
4. Edit the schedule contents.
  - To check the detail contents, check 'Add Schedule' Category.

## Load exception date

You can load already set exception date.

1. In the left menu tab, click **[Control] > [Schedule Control]** menu.
  - The schedule control screen is displayed.
2. In the schedule list, click **[Add Schedule]** button.
  - The Add schedule screen is displayed.
3. In the exception date tab, click **[Load]** button
  - The exception date set in **[Setting]-[system setting]'s schedule exception date setting** is updated and displayed.

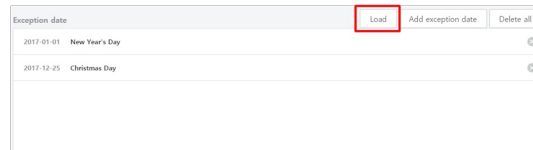

Exception date		Load	Add exception date	Delete all
2017-01-01	New Year's Day			
2017-12-25	Christmas Day			



## Add exception date

You can add new exception date.

1. In the left menu tab, click **[Control] > [Schedule Control]** menu.
  - The schedule control screen is displayed.
2. In the schedule list, click **[Add Schedule]** button.
  - The Add schedule screen is displayed.
3. In the exception date tab, click **[Add Exception Date]** button
  - The Add exception date screen is displayed.

Add exception date ×

**Set exception date**

Name

Input exception date name

2017 January						
MON	TUE	WED	THU	FRI	SAT	SUN
26	27	28	29	30	31	01
02	03	04	05	06	07	08
09	10	11	12	13	14	15
16	17	18	19	20	21	22
23	24	25	26	27	28	29
30	31	01	02	03	04	05

Cancel Apply

4. Input the desired exception date name.
5. Select the exception date to set.
6. When selection is completed, click **[Apply]** button.

## Delete exception date

You can delete already registered exception date.

1. In the left menu tab, click **[Control] > [Schedule Control]** menu.
  - The schedule control screen is displayed.
2. In Edit schedule screen, click **[X]** button to delete exception date.
  - To delete the entire category, click **[Delete All]** button.

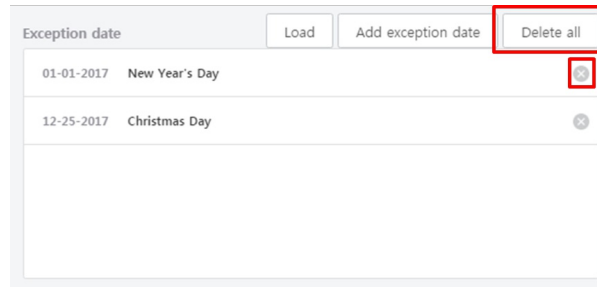

## InterLocking

InterLocking is the function to interface with one or more equipment and to control output operation when input condition is satisfied. For InterLocking, you need to group the equipment to mutual interface in one group and apply the control setting. It describes the method to create and manage the group and equipment interface control method.

- In the left menu tab, click **[Control] > [InterLocking]** menu.
  - The InterLocking screen is displayed.

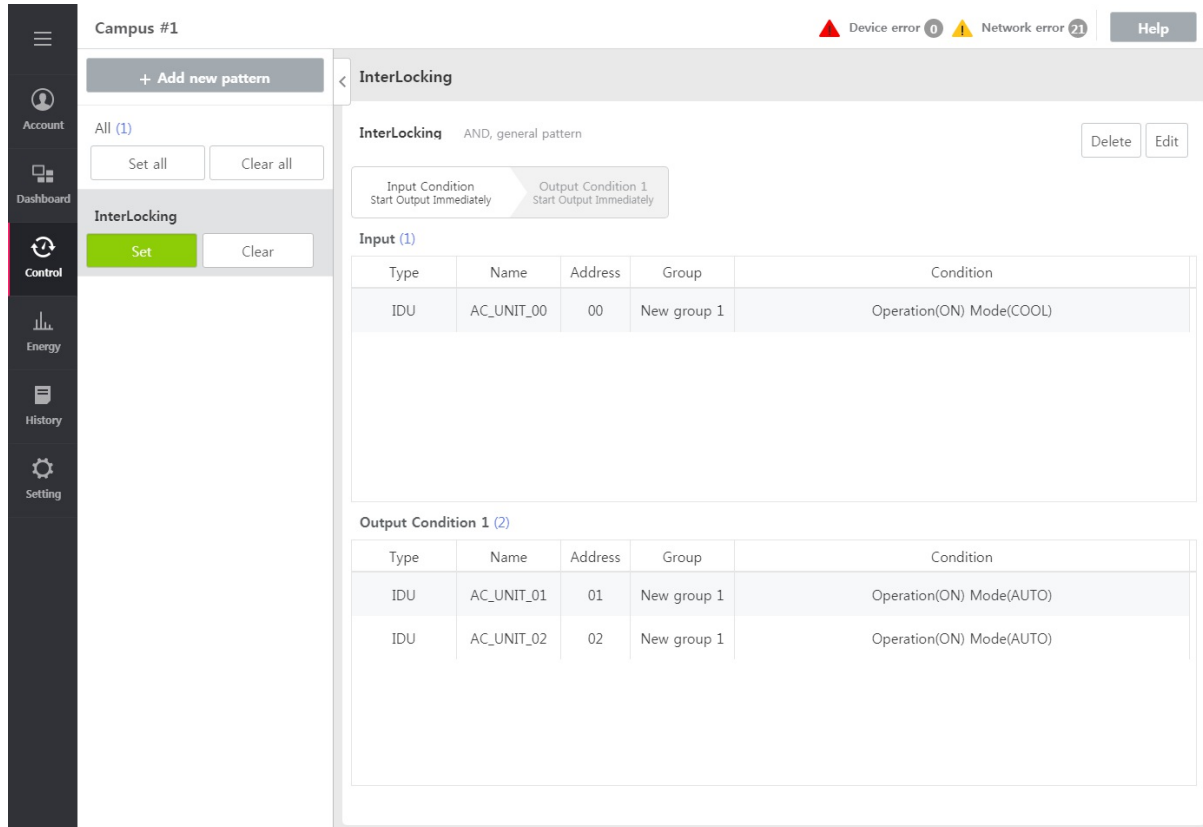

- In the group list, select the group to check the setting.
  - The the corresponding group's setting status is displayed in the screen.
- In the group list, when you click **[Set] / [Clear]** button, you can set the InterLocking operation.
- To start all the registered group, click **[Set All]** button, and to stop all, click **[Clear All]** button.

### Note

#### Recommended specification

- Equipment interface control : No. of patterns is 20, No. of input devices is 500, and No. of output devices is 1000**
- If it is set to be over the recommended specification, performance degradation may occur.**

## Add/edit InterLocking

You can add and edit new InterLocking.

- In the left menu tab, click **[Control] > [InterLocking]** menu.
  - The InterLocking screen is displayed.
- Click **[+ Add new pattern]** button.
  - Add InterLocking screen is displayed.

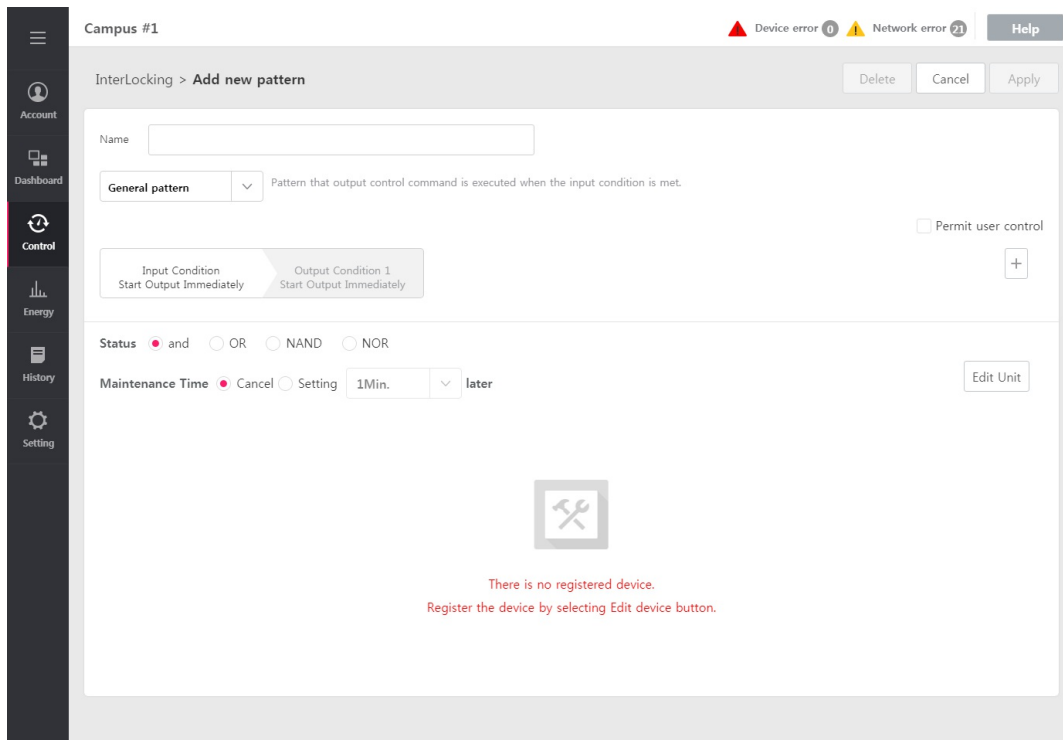

3. In the InterLocking name input field, input the desired InterLocking name.
4. Select pattern type.

Category	Description
General pattern	<ul style="list-style-type: none"> <li>The pattern that output control command is executed when the input condition is satisfied</li> </ul>
Copy pattern	<ul style="list-style-type: none"> <li>The pattern that the output device follows the input device's status (Some control functions may not be copied.)</li> <li>You can add only 1 device to input condition, and only the device with the same attribute with the added input device is registered to the output device</li> </ul>
Emergency pattern	<ul style="list-style-type: none"> <li>The pattern that it recognizes as emergency situation when input condition is satisfied</li> <li>When the input condition is satisfied, it tells the alarm with screen and sound</li> </ul>
1:1 pattern	<ul style="list-style-type: none"> <li>Pattern to conveniently register many devices if input device is the same as output device</li> </ul>

5. Select whether to permit user control. (Only general pattern is possible)
  - When check box is selected, even if the status is changed by the InterLocking, user may change the status of the equipment.
6. Set equipment interface condition. When you press **[+]** button, you can add up to 3 output conditions.
  - It only appears when input condition tab is selected.

Category	Description
Status	<ul style="list-style-type: none"> <li>AND : all device conditions match</li> <li>OR : one or more device conditions match</li> <li>NAND : one or more device conditions do not match</li> <li>NOR : no condition matches</li> </ul>
Maintaining time	<p>If it is set, while all input conditions are met, output condition control after maintaining time</p> <p>Press <b>[▼]</b> button to select maintaining time</p>

- It only appears when output condition tab is selected.

Category	Description
Send e-mail	<p>When check box is selected, if the corresponding event is executed in ACP, whether event occurred is sent to the e-mail set in Setting &gt; error notice setting &gt; receiving e-mail address</p> <ul style="list-style-type: none"> <li>ACP shall be connected to internet network that can send e-mail.</li> </ul>
Delay time	<p>If it is set, when input condition is met, output condition is controlled after the registered delay time</p> <p>Press <b>[▼]</b> button to select delay time</p> <ul style="list-style-type: none"> <li>If input condition is met, even if it becomes a status that does not meet the input condition during the delay time, output</li> </ul>

condition is controlled after delay time.

- To add device, click **[Edit Unit]** button.
  - The Edit Unit popup window appears.
- In the selectable device list, click the checkbox of the device to register and click **[◀]** button.
  - To register several groups at once, click the checkbox of the group to register and click **[◀]** button.
  - The selected devices are added to the registered device list.

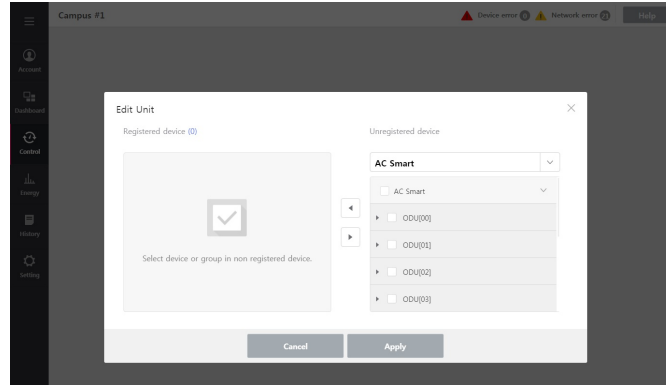

- When device registration is completed, click **[Apply]** button.
- Click registered device's **[Condition]** button.

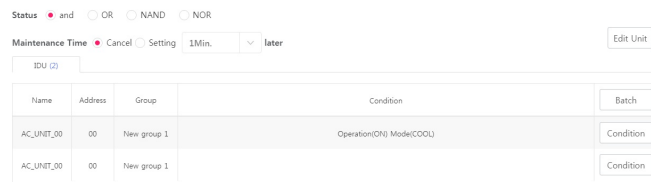

- In the right side control window section, set the desired control status.
- Select output condition tab, and run No. 7~11 processes in the order.
- To save the set contents, click **[Apply]** button.

## Delete InterLocking

You can delete registered InterLocking.

- In the left menu tab, click **[Control] > [InterLocking]** menu.
  - The InterLocking screen is displayed.
- In the InterLocking list, select the group to delete, and click **[Delete]** button.
- When InterLocking delete popup window appears, click **[Yes]** button.
  - In the InterLocking list, the selected category is deleted.

## Time limit control

You can control the device to operate for the set time and automatically stop.

1. In the left menu tab, click **[Control] > [Time limit control]** menu.
2. In the group list, select the group to check the setting.
  - The the corresponding group's setting status is displayed in the screen.
3. In the group list, you can click **[Set] / [Clear]** button to set the time limit operation.
4. To start all the registered group, click **[Set All]** button, and to stop all, click **[Clear All]** button.

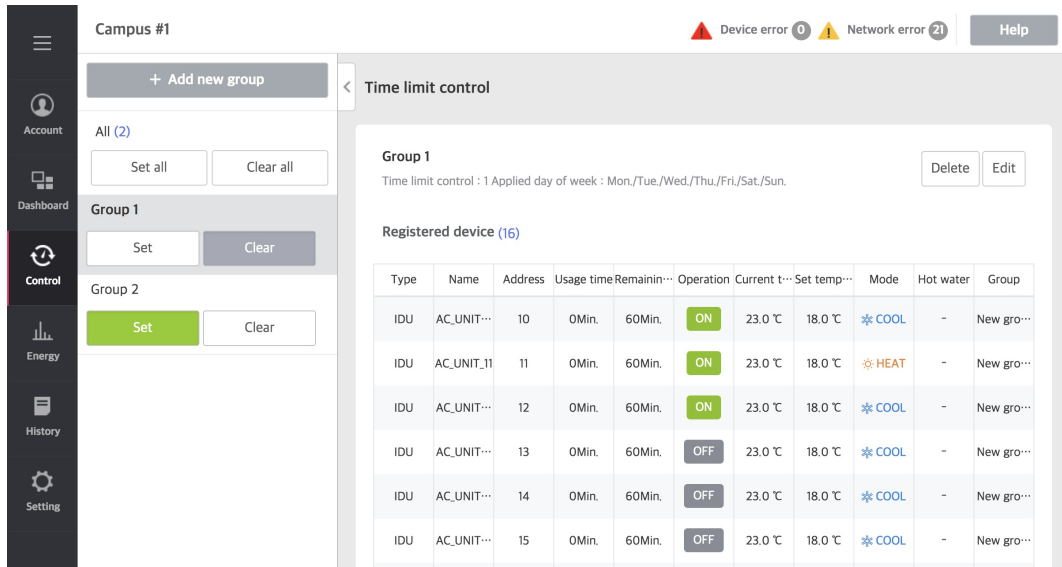

**Registered device (16)**

Type	Name	Address	Usage time	Remainin...	Operation	Current t...	Set temp...	Mode	Hot water	Group
IDU	AC_UNIT...	10	0Min.	60Min.	ON	23.0 °C	18.0 °C	* COOL	-	New gro...
IDU	AC_UNIT_11	11	0Min.	60Min.	ON	23.0 °C	18.0 °C	* HEAT	-	New gro...
IDU	AC_UNIT...	12	0Min.	60Min.	ON	23.0 °C	18.0 °C	* COOL	-	New gro...
IDU	AC_UNIT...	13	0Min.	60Min.	OFF	23.0 °C	18.0 °C	* COOL	-	New gro...
IDU	AC_UNIT...	14	0Min.	60Min.	OFF	23.0 °C	18.0 °C	* COOL	-	New gro...
IDU	AC_UNIT...	15	0Min.	60Min.	OFF	23.0 °C	18.0 °C	* COOL	-	New gro...

### Note

#### Recommended specification

- **Time limited operation : No. of groups is 10**
- **If it is set to be over the recommended specification, performance degradation may occur.**

## Add/edit Time limit control group

You can add and edit Time limit control group.

1. In the left menu tab, click **[Control] > [Time limit control]** menu.
  - Time limit control screen is displayed.
2. Click **[+ Add New Group]** button.
  - Add new group screen is displayed.
  - During the editing, when you select the group to edit and click **[Edit]** button, the following screen is displayed.

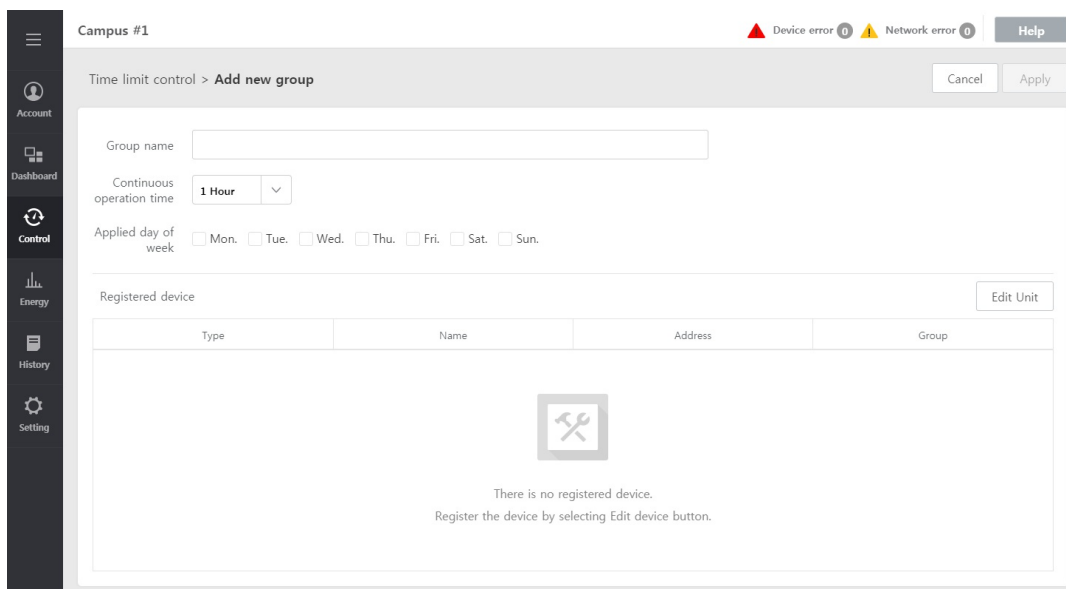

3. Input group name.
4. Select continuous operation time and applied day of week.

Category	Description
Continuous operation time	<ul style="list-style-type: none"> <li>● Press [▼] button, and set the desired continuous operation time (1 hour ~ 4 hours)</li> </ul>
Applied day of week	<ul style="list-style-type: none"> <li>● Select checkbox to select day of week to run the time limit operation</li> </ul>

5. To add device, click **[Edit Unit]** button.
  - The Edit Unit popup window appears.

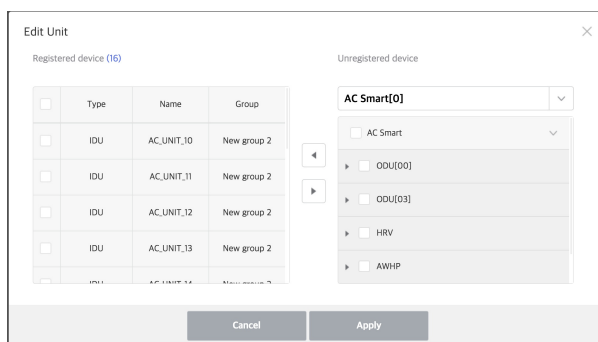

6. In the selectable device list, click the checkbox of the device to register and click **[◀]** button.
  - For time limited control, you can register all devices except DI, DO, ON/OFF, Chiller, and Exp.I/O device.
  - To register several groups at once, click the checkbox of the group to register and click **[◀]** button.
  - The selected devices are added to the registered device list.
7. When device registration is completed, click Edit Unit popup window's **[Apply]** button.
8. Click **[Apply]** button at the top right side.

## Delete Time limit control

You can delete Time limit control group.

1. In the left menu tab, click **[Control] > [Time limit control]** menu.
  - Time limit control screen is displayed.
2. In the group list, select the group to delete and click **[Delete]** button.
3. When Delete group popup window appears, click **[Yes]** button.

## Energy Usage

It describes the method to check the device's operation time, electricity usage amount, gas usage amount, TOE, and CO<sub>2</sub> with values and graph.

1. In the left menu tab, click **[Energy] > [Energy Usage]** menu.

- Energy usage amount screen is displayed.

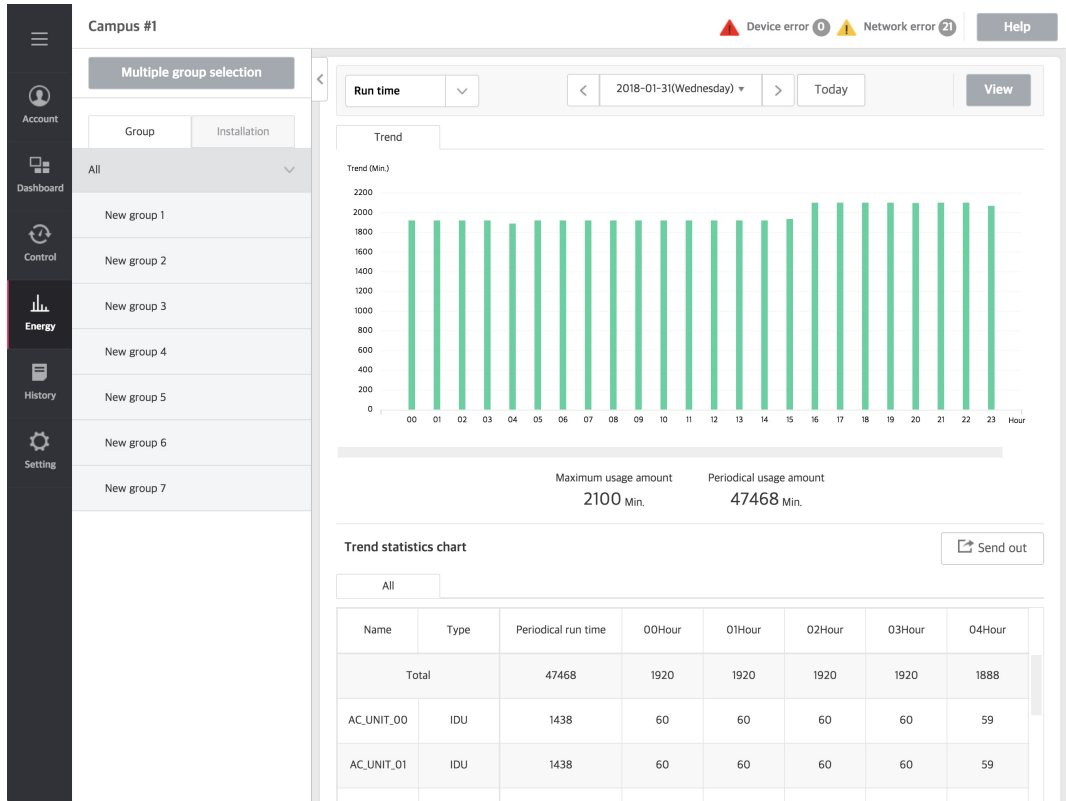

2. In the group list, select group to view.

3. In the top left side box, select the category to view.

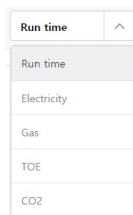

4. Set the viewing period.

Category	Description
Day	Set the desired day in mini calendar
Month	Set the desired month in mini calendar
Period	Set the desired period in mini calendar
Today	Set today's date as the base date

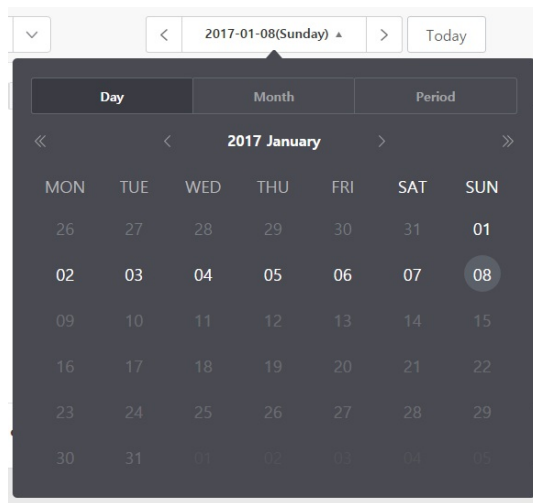

5. To view the set contents, click **[View]** button.

- Energy usage amount of the set period is displayed.
- To save the viewed contents, click **[Send Out]** button.

(In AC Smart 5 Device, it is stored in USB.)

### Note

- **Viewing power is possible only when PDI is installed.**
- **If PDI is installed, indoor unit, direct cooling type ventilation, and system boiler address shall be set to avoid overlapping.**
- **The power consumption amount appeared in the program may be a little different from the power consumption amount marked on actual bill.**
- **In [Setting]-[Installing], only ACP with [Electricity Usage Amount] set can be monitored.**
- **Viewing gas is possible only when GDI is installed.**
- **The gas amount appeared in the program may be a little different from the gas amount marked on actual bill.**
- **In [Setting]-[Installing], only ACP with [Gas usage amount] set can be monitored.**
- **Energy monitor maintains only the last 1 year's data.**
- **Hourly data is provided up to last 3 months.**

## Energy Navigation

Energy Navigation is the function that can control **[ODU capacity]/[IDU Operation Rate]/[IDU]** for each level according to the power usage amount forecast and current power usage amount to be able to manage the monthly power usage amount below the target amount.

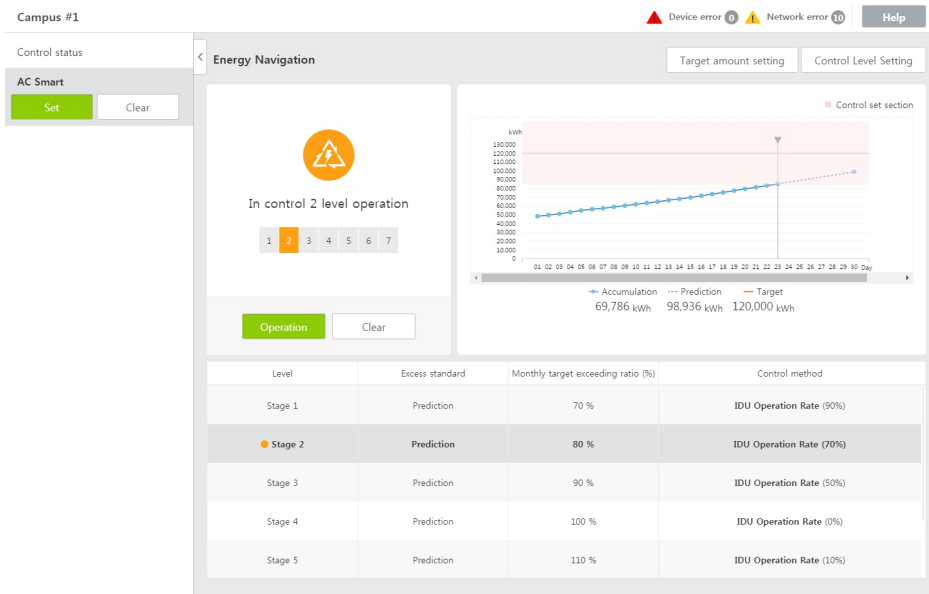
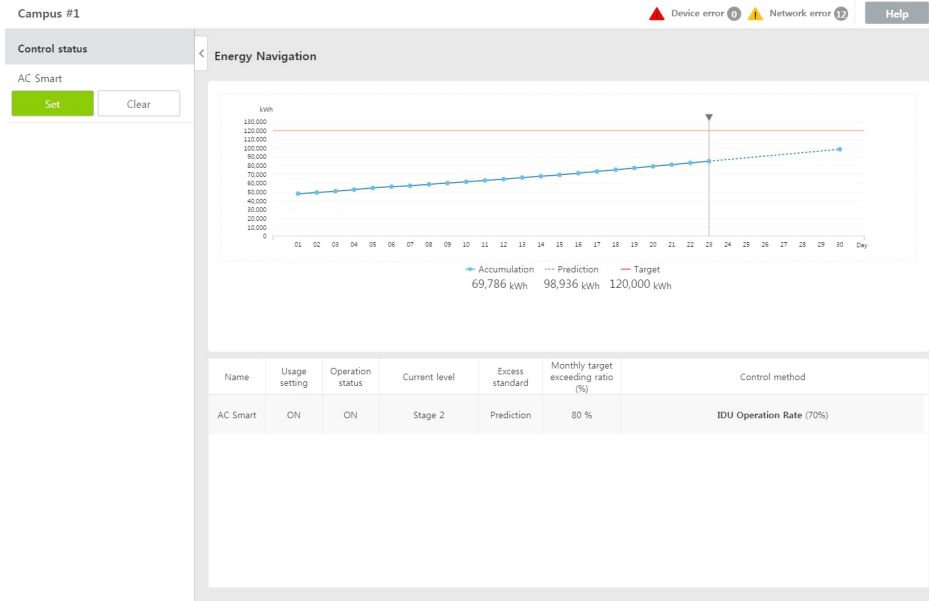

## Add target amount

You can add Energy Navigation's target amount.

1. In the left menu tab, click **[Energy] > [Energy Navigation]** menu.
2. In the control status tab, click the group to add target amount.
3. Click **[Target amount setting]** button at the top right side.
  - Target amount setting window appears.

Energy target management(AC Smart) Cancel Apply

Input method  Direct input  Decrease ratio compared to the previous year

Monthly target amount Decrease ratio

Batch input  Apply

Month	Target value	Month	Target value
1Month	100000	7Month	100000
2Month	100000	8Month	100000
3Month	100000	9Month	100000
4Month	100000	10Month	100000
5Month	100000	11Month	100000
6Month	100000	12Month	100000

Total 1200000 kWh

100 %   
 Previous year

4. Input target amount in each month.
  - To input in all months at once, input target amount in batch input field and click **[Apply]** button on the side.
5. When target amount input is completed, click **[Apply]** button at the top right side.
6. When Apply notice window appears, click **[Check]** button.

## Control Level Setting

You can set control level of Energy Navigation.

1. In the left menu tab, click **[Energy] > [Energy Navigation]** menu.
2. In the control status tab, click the group to set the control level.
3. Click **[Control Level setting]** button at the top right side.
  - Control Level Setting window appears.

Energy Navigation > Control Level Setting Cancel Apply

Set control execution method AUTO Manual Help

Control Level Setting + Add level

Level	Excess standard	Monthly target exceeding ratio (%)	Control method		Delete
1	Prediction <input type="text"/>	70 % <span style="float: right;">▲ ▼</span>	ODU capacity <input type="text"/>	90% <input type="text"/>	<input type="text"/>
2	Prediction <input type="text"/>	80 % <span style="float: right;">▲ ▼</span>	ODU capacity <input type="text"/>	70% <input type="text"/>	<input type="text"/>
3	Prediction <input type="text"/>	90 % <span style="float: right;">▲ ▼</span>	ODU capacity <input type="text"/>	50% <input type="text"/>	<input type="text"/>
4	Prediction <input type="text"/>	100 % <span style="float: right;">▲ ▼</span>	ODU capacity <input type="text"/>	0% <input type="text"/>	<input type="text"/>

4. Select control run method setting.

Category	Description
AUTO	At the time of the alarm, control method set for each level is automatically executed.
Manual	At the time of the alarm, you select whether to execute the control method set for each level.

5. Click Control Level Setting window's **[+Add Level]** button.
6. Set the Control Level Setting categories.

Category	Description
Excess Standard	You can select between usage amount forecast and actual usage amount.

Monthly target excess ratio	You can set in 10% unit within 70~130%
Control method	ODU capacity: You can set in 10% unit within 0~100%. IDU operation ratio: You can set in 10% unit within 0~100%. IDU: IDU control

7. When setting is completed, click **[Apply]** button at the top right side.
8. When Apply notice window appears, click **[Check]** button.

## Peak control

In the control status, you can check ACP name, control method, operation method, control status, and target operation ratio.

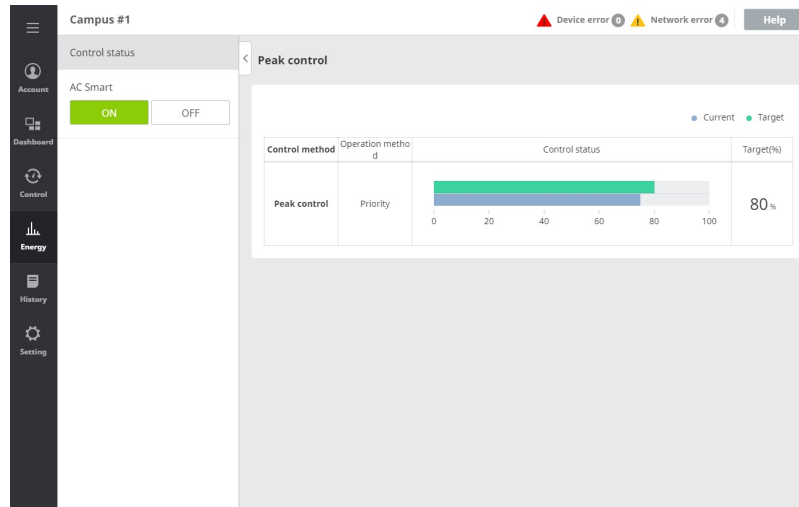

Peak control is a function to set the target operation rate to limit the maximum power usage and to control total power usage not to exceed the target operation rate. To prevent total power usage from exceeding target operation rate, cooling mode is automatically converted to wind only mode according to the priority and heating mode automatically stops, so the power usage amount can be saved.

1. In the left menu tab, click **[Energy] > [Peak control]** menu.
  - Peak control screen is displayed.
2. In ACP list, select ACP to control.
  - The corresponding ACP's control setting status is displayed in the screen.

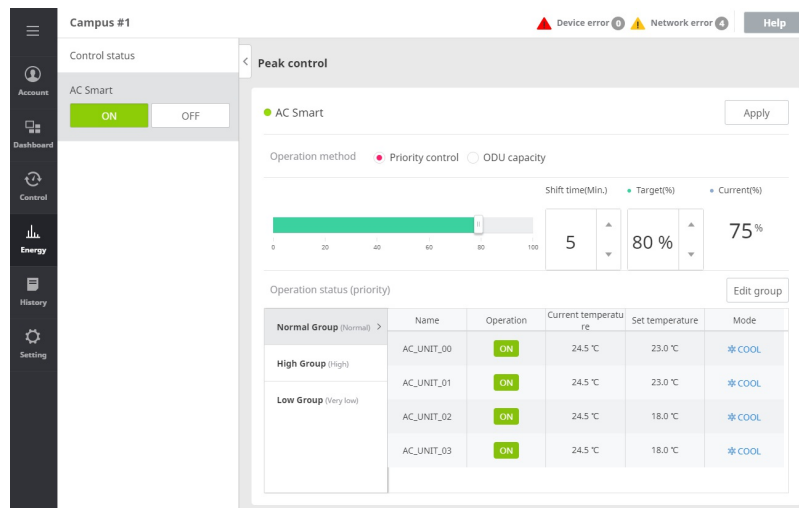

3. In the control information display, set the desired control status.

Category	Description
Operation Method	<ul style="list-style-type: none"> <li>• Outdoor unit capacity control: Target operation ratio is applied in the units of outdoor unit to control outdoor unit capacity operation ratio</li> <li>• Priority control: Controls according to the priority of ACP lower level groups</li> </ul>
Operation ratio bar	<ul style="list-style-type: none"> <li>• Indoor unit's target operation ratio is displayed as bar graph</li> <li>• You can drag the bar of the graph to set the target operation ratio</li> </ul>
Current(%)	Among all of the selected ACP indoor units, it marks the % reached by the device currently in operation
Target(%)	Press <b>[▲]/[▼]</b> button to set the target operation ratio
Shift time(min.)	<ul style="list-style-type: none"> <li>• Press <b>[▲]/[▼]</b> button to set the cycle of forced operation stop in min. unit</li> <li>• You can set to 5 ~ 15 min. range in the units of 1 min.</li> </ul>
Operation status	It displays device name/whether operating/current temperature/set temperature/mode information

---

4. To apply the control setting, click **[Apply]** button.

- The set control status is saved.

5. To start the corresponding group with the set status, click the group list's **[ON]** button. To stop the corresponding group's operation, click the group list's **[OFF]** button.

## Operation History

You can view user/automatic control's operation history and the connected device's status change or error status.

1. In the left menu tab, click **[History]** > **[Operation History]** menu.

- Operation history screen is displayed

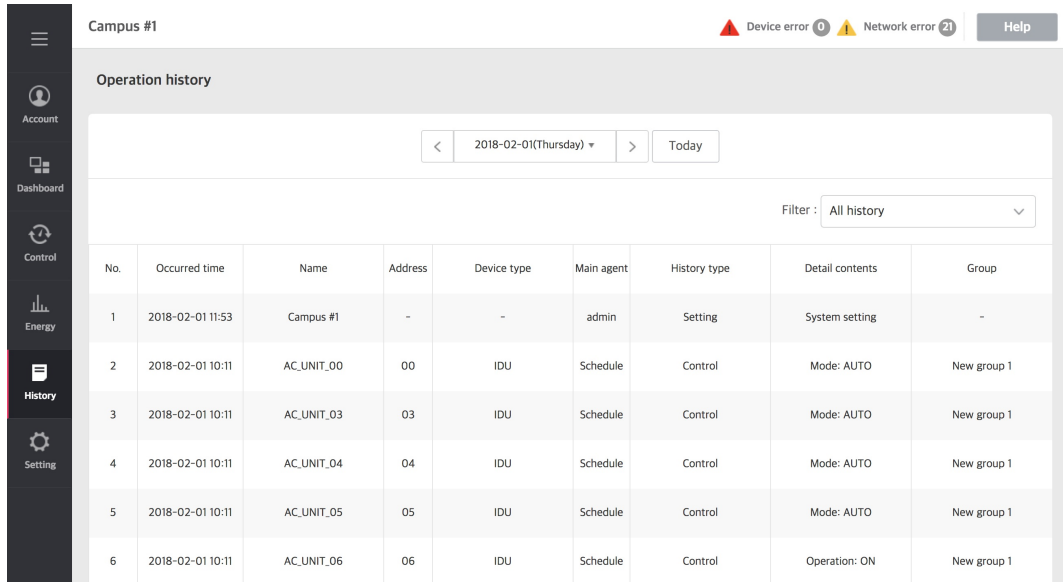

No.	Occurred time	Name	Address	Device type	Main agent	History type	Detail contents	Group
1	2018-02-01 11:53	Campus #1	-	-	admin	Setting	System setting	-
2	2018-02-01 10:11	AC_UNIT_00	00	IDU	Schedule	Control	Mode: AUTO	New group 1
3	2018-02-01 10:11	AC_UNIT_03	03	IDU	Schedule	Control	Mode: AUTO	New group 1
4	2018-02-01 10:11	AC_UNIT_04	04	IDU	Schedule	Control	Mode: AUTO	New group 1
5	2018-02-01 10:11	AC_UNIT_05	05	IDU	Schedule	Control	Mode: AUTO	New group 1
6	2018-02-01 10:11	AC_UNIT_06	06	IDU	Schedule	Control	Operation: ON	New group 1

2. Set the period to view.

Category	Description
Viewing period	<ul style="list-style-type: none"> <li>• Day: Views the history of the selected date</li> <li>• Today: Views today's history</li> </ul>

3. In filter category, select device or history type.

- You can click the checkbox to select multiple information.
- You can initialize the selected contents through **[Initialization]** button.

4. When device and history type selection is completed, click **[Apply]** button.

- The operation history of the set period is displayed.



## Energy Navigation History

You can view history of Energy Navigation alarm and control operation.

1. In the left menu tab, click **[History]** > **[Energy Navigation History]** menu.

- Energy navigation screen is displayed.

**Energy navigation history**

Number of events : 53 2016-12-16 ~ 2017-01-16

No.	Occurred time	Exceeding standard	Energy warning contents	Execution control option
1	2017-01-16 15:17:26	Prediction	Exceeded monthly target 70% amount	AUTO, ODU capacity, 90%
2	2017-01-16 15:17:21	Prediction	Exceeded monthly target 70% amount	AUTO, ODU capacity, Pause
3	2017-01-16 10:17:46	Prediction	Exceeded monthly target 70% amount	AUTO, ODU capacity, 90%
4	2017-01-16 10:00:39	Prediction	Exceeded monthly target 130% amount	AUTO, ODU capacity, 0%
5	2017-01-12 17:39:27	Prediction	Exceeded monthly target 70% amount	AUTO, ODU capacity, 90%
6	2017-01-11 04:07:15	Prediction	Exceeded monthly target 80% amount	AUTO, ODU capacity, 70%
7	2017-01-11 00:37:15	Prediction	Exceeded monthly target 90% amount	AUTO, ODU capacity, 50%
8	2017-01-10 09:37:13	Prediction	Exceeded monthly target 80% amount	AUTO, ODU capacity, 70%
9	2017-01-10 00:22:12	Prediction	Exceeded monthly target 90% amount	AUTO, ODU capacity, 50%
10	2017-01-09 15:12:11	Prediction	Exceeded monthly target 80% amount	AUTO, ODU capacity, 70%

2. Select device to view the history.

3. Set the start date and end date of the period to view history.

4. To view the set contents, click **[View]** button.

- Energy Navigation history of the set period is displayed.

## Operation Trend

Operation trend function is the function to provide the past status change of the selected device to help establishing reasonable site operation plan.

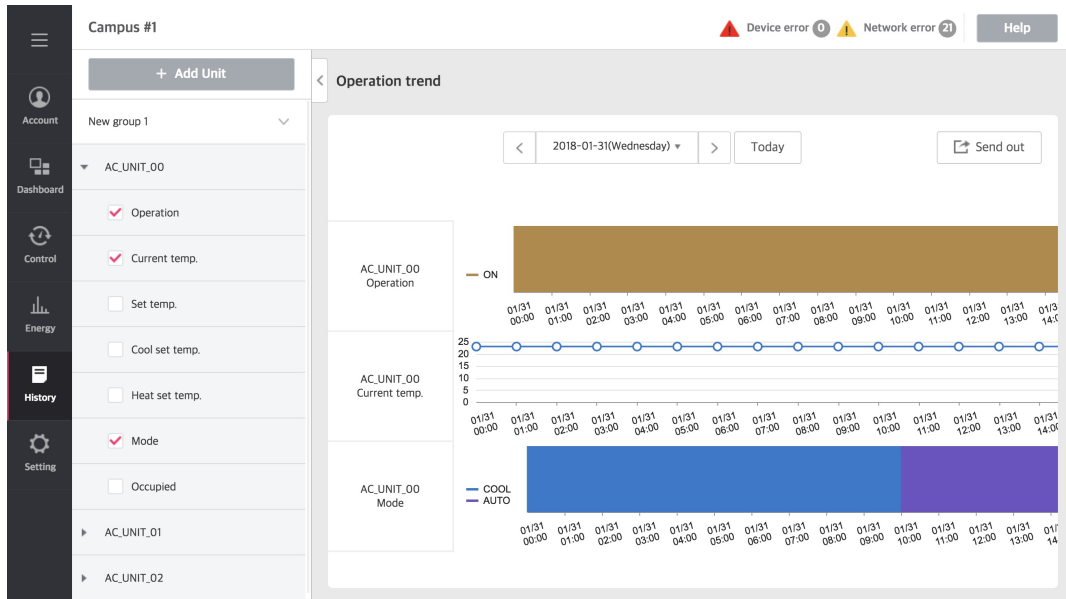

## Add Device

You can add unit to view operation trend.

1. In the left menu tab, click **[History] > [Operation Trend]** menu.
  - Operation trend screen is displayed.
2. Click **[+ Add Unit]** button.
  - Add device screen is displayed.
3. In the unregistered device list, click the checkbox of the device to register and click **[◀]** button.
  - To register several devices at once, click the check boxes of the devices to register and click **[◀]** button.
  - The selected devices are added to the registered device list.
4. To apply in Edit Unit popup window, click **[Apply]** button.

## View Information

You can view the selected device's operation trend information.

1. In the left menu tab, click **[History] > [Operation Trend]** menu.
  - Operation trend screen is displayed.
2. In the device list tab section, select the category of the device to view.
3. Select the period to view operation trend.

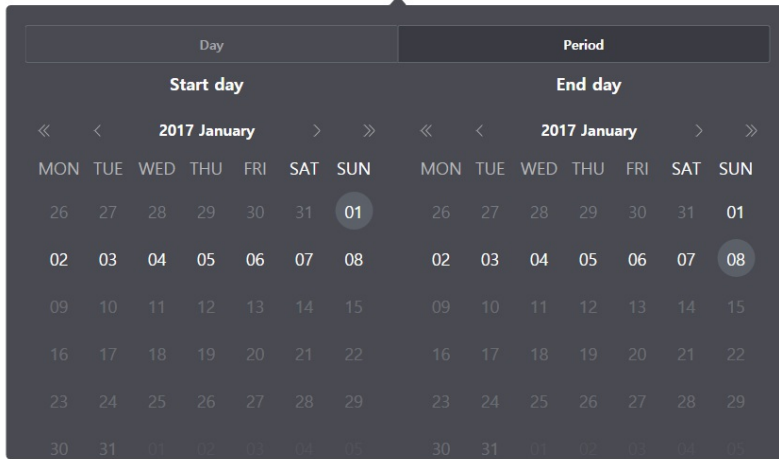

Category	Description
Period	<p><b>[Day]</b> button: Select the desired date in mini calendar and set as the base date</p> <p><b>[Period]</b> button: Set the start date and end date of the period to view</p> <ul style="list-style-type: none"> <li>The maximum period to view is 1 week.</li> </ul> <p><b>[Today]</b> button: Set today's date as the base date</p>

## Send out information

You can send out the viewed device's operation trend information.

- In the left menu tab, click **[History]** > **[Operation Trend]** menu.
  - Operation trend screen is displayed.
- In the left side category, select the category to send out and click **[Send Out]** button at the top right side.

(In AC Smart 5 Device, it is stored in USB.)

### Note

Each device stores the following information.

- Indoor unit : operation, current temperature, set temperature, cooling set temperature, heating set temperature, operation mode, occupancy
- HRV: operation, mode, current temperature (only for direct cooling type ventilation), set temperature (only for direct cooling type ventilation)
- AHU: operation, ventilation temperature, air supply temperature, set temperature, mode, air supply humidity, ventilation humidity
- AWHP: Operation, Water inlet temperature, Water outlet temperature, Hot water temperature, Set temperature, Hot water set temp., Mode, Hot water operation
- Chiller: Operation, Water inlet temperature, Water outlet temperature, Mode
- DOKIT: Operation
- DI: Operation
- DO: Operation
- Exp.I/O's Port : value

## Cycle

You can view indoor/outdoor unit and chiller's cycle information.

## Outdoor Unit

It provides the selected outdoor unit's cycle information data.

1. In the left menu tab, click **[History] > [Cycle]** menu.

- Cycle screen is displayed.

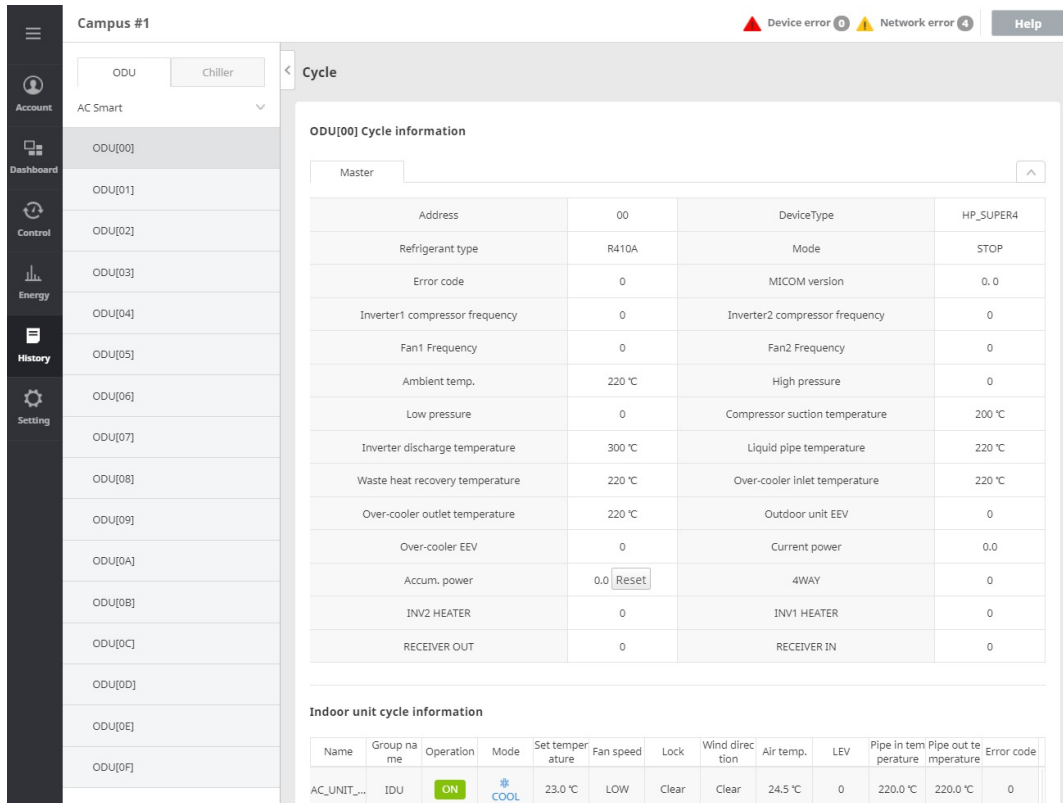

Category	Description
Outdoor unit cycle information	Master/slave outdoor unit information display
Indoor unit cycle information	Displays all indoor unit information connected to the outdoor unit

2. In the outdoor unit list, select the outdoor unit to check cycle information.

- The corresponding outdoor unit's cycle information is displayed.

### Note

**You can view only when the outdoor unit providing cycle information is installed.**

## Chiller

It provides the selected chiller's cycle information data.

1. In the left menu tab, click **[History] > [Cycle]** menu.

- Cycle screen is displayed.

2. In the chiller list, select the chiller to check cycle information.

- The corresponding chiller's cycle information is displayed.

< Cycle

### SCROLL AIR Cycle information

Common Cycle 1 Cycle 2 Cycle 3 Cycle 4



Operation	OFF	Heating set temperature	0.0 °C
Outside air temperature	0.0 °C	Chilled water leaving temp.	0.0 °C
Operation current	0 A	Chilled water entering temp.	0.0 °C
Start standby time	0 Sec	Chilled water flux switch	OFF
Mode	❄️ COOL	Chilled water pump output status	OFF
Demand limit ratio	0 %	Chilled water pump interface status	OFF
Cool set temperature	0.0 °C	Total Run time	0 Hours

## Device setting

You can change AC Smart setting, add device, and change registered device's setting.

### AC Smart 5 edit

You can change AC Smart setting.

1. In the left menu tab, click **[Setting] > [Installing]** menu.

- Device setting screen is displayed.

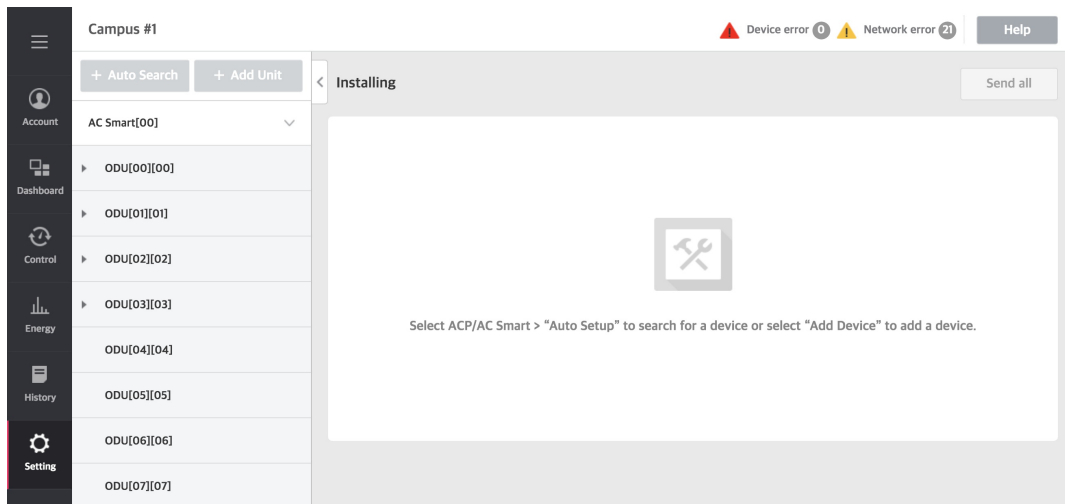

2. In device list, select AC Smart.

- AC Smart edit screen is displayed.
- In device edit area, you can change AC Smart setting information.

AC Smart 5

Apply

Energy Management  Peak control  Peak & energy navigation

Operation time Set Clear

Electricity usage amount Set Clear

Gas usage amount Set Clear

Comm. type LGAPI ▼

Current status : LGAPI

LGAP setting Master ▼

2Set Auto Mode IDU ▼

CH1 Setting MODBUS\_9600 ▼

Address Lock Cancel ▼

Category	Description
Energy Management	Select among peak control / peak control and energy navigation
Operation Time	Operation time collection and view Set/Clear
Electricity usage amount	Electricity usage amount collection and view Set/Clear
Gas usage amount	Gas usage amount collection and view Set/Clear
Communication method	LGAPI / LGAPII setting
LGAP setting	Communication Master / Slave setting
2Set automatic mode	Press <b>[▼]</b> button to select main agent of 2Set automatic mode <ul style="list-style-type: none"> <li>● Central controller / indoor unit</li> </ul>
CH1 setting	Press <b>[▼]</b> button to select communication type of the device to connect to CH1 port <ul style="list-style-type: none"> <li>● LGAP: for indoor unit, ventilation, direct cooling type ventilation, and system boiler connection</li> <li>● LGAP_AHU: for AHU (general, all fresh air, waste heat recovery) connection</li> <li>● MODBUS_9600, MODBUS_19200: for AHU (modular air conditioner, modular all fresh air, DOAS), Exp.I/O, and chiller connection</li> </ul>
Address lock	When it is set, you cannot change address in indoor unit and ventilation remote controller

**Note**

Some models do not support LGAPII.

**When the controller is set as slave, register the IDU or other devices to be controlled by the corresponding controller. At this time, it should not be registered in duplicate with other slave controllers.**

3. When input is completed, click **[Apply]** button.
4. Click **[Send All]** button.

## Automatic setting

You can automatically search device connected to AC Smart and register.

1. In the left menu tab, click **[Setting] > [Installing]** menu.
  - Device setting screen is displayed.
2. In device list, select AC Smart, and click **[Auto Search]** button.
3. To overwrite AC Smart device setting on the existing setting, click **[Check]** button.
  - AC Smart device setting status is applied.
4. When automatic setting is finished, before device edit, click **[Send All]** button.

### Note

- **Automatic setting takes about 10 min.**
- **Some AHU (modular air conditioner, modular all fresh air, DOAS), chiller, and Exp.I/O do not support automatic setting function.**
- **Exp.I/O is activated when you check 'use' in device edit window after device registration.**

## Add Device

You can additionally register new device to the device list.

1. In the left menu tab, click **[Setting] > [Installing]** menu.
  - Device setting screen is displayed.
2. Click **[+ Add Unit]** button.
  - Add device screen is displayed.

3. In the device list, select upper level group to add device.
  - When you select AC Smart in device list, you can add outdoor unit, ventilation, system boiler, AHU, Chiller, ON/OFF device, DI, DO, and Exp.I/O.
  - In the device list, when outdoor unit is selected, you can add only indoor units.
4. In Add device section, input the setting information of the device to add.
  - According to the selected device, the setting category according to the corresponding device is displayed differently. For the setting information of each device, refer to the next page.
5. To save the set contents, click **[Apply]** button.
6. To complete adding device, click **[Send All]** button.

## Device edit

In device list, you can edit registered device.

1. In the left menu tab, click **[Setting] > [Installing]** menu.
  - Device setting screen is displayed.
2. In device list, select device to edit.
3. Device setting screen is displayed.
4. Edit device setting information.
  - According to the selected device, the setting category according to the corresponding device is displayed differently. For the setting information of each device, refer to the next page.
5. To save the set contents, click **[Apply]** button.
6. To complete device edit, click **[Send All]** button.

## Delete Device

In the device list, you can delete registered device.

1. In the left menu tab, click **[Setting] > [Installing]** menu.
  - Device setting screen is displayed.
2. In device list, select device to delete, and click **[Delete]** button.
3. When device delete popup window appears, click **[Yes]** button.
  - In device list, selected item is deleted.
4. To complete device deleting, click **[Send All]** button.

## Setting information of each device

Setting information of each device is as follows.

- Outdoor Unit
- IDU
- HRV
- AWHP
- AHU
- Chiller
- DOKIT
- DI/DO
- Exp.I/O
- Exp.I/O's lower level setting



### Outdoor Unit

Select device type to add to AC Smart

ODU     
  HRV     
  AWHP  
 AHU     
  Chiller     
  DOKIT  
 DI     
  DO     
  EXP. I/O

---

ACP name

Address

Name

Model

Capacity

---

Add all

Category	Description
ACP name	The corresponding device's upper level ACP name
Address	Device address
Name	Device name to be displayed in the system <ul style="list-style-type: none"> <li>For batch add, it is displayed as "Name_device address" form</li> </ul>
Model	Product model name
Capacity	Product capacity
Add All	When checkboxes are selected, all selected devices are added



IDU

ACP name

ODU name

Address

Name

Model

Type  ▼

Capacity

---

Add all  EA

Category	Description
ACP name	The corresponding device's upper level ACP name
ODU name	Name of the outdoor unit connected to the corresponding device
Address	Device address
Name	Device name to be displayed in the system <ul style="list-style-type: none"> <li>For batch add, it is displayed as "Name_device address" form</li> </ul>
Model	Product model name
Type	Indoor unit type selection
Capacity	Product capacity
Add All	When checkboxes are selected, all selected devices are added



HRV

Select device type to add to AC Smart

ODU      HRV      AWHP      AHU  
 Chiller      DOKIT      DI      DO  
 EXP. I/O

---

ACP name:

Type:

Address:

Name:

Model:

Capacity:

---

Add all

Category	Description
ACP name	The corresponding device's upper level ACP name
Type	Ventilation type selection
Address	Device address
Name	Device name to be displayed in the system <ul style="list-style-type: none"> <li>For batch add, it is displayed as "Name_device address" form</li> </ul>
Model	Product model name
Capacity	Product capacity
Add All	When checkboxes are selected, all selected devices are added



## AWHP

Select device type to add to AC Smart

ODU     HRV     AWHP     AHU     Chiller  
 DOKIT     DI     DO     EXP. I/O

---

ACP name:

Address:

Name:

Model:

Capacity:

Control method:  Hot water control     Water in/out control     All

Current Temp 1  
 Water out     Water in     Indoor     Hot water     Do not use

Current Temp 2  
 Water out     Water in     Indoor     Hot water     Do not use

Current Temp 3  
 Water out     Water in     Indoor     Hot water     Do not use

Set temperature  
 Water in/out     Indoor

Add all

Category	Description
ACP name	The corresponding device's upper level ACP name
Address	Device address
Name	Device name to be displayed in the system <ul style="list-style-type: none"> <li>For batch add, it is displayed as "Name_device address" form</li> </ul>
Model	Product model name
Capacity	Product capacity
Control method	Select control method
Current Temp 1	Type of the current temperature to be displayed first
Current Temp 2	Type of the current temperature to be displayed second
Current Temp 3	Type of the current temperature to be displayed third
Set temperature	Type of the set temperature to control
Add All	When checkboxes are selected, all selected devices are added



# AHU

Select device type to add to AC Smart

ODU     HRV     AWHP     AHU     Chiller  
 DOKIT     DI     DO     EXP. I/O

---

ACP name:

Address:

Name:

Model:

AHU Type:  Normal     All outside air device     Multi-fan general     Multi-fan all outside air unit

Additional function:  None     Automatic ventilation     Humidify     Automatic ventilation, humidification

Room Temp:  Air supply standard     Ventilation standard

---

Add all

Category	Description
ACP name	The corresponding device's upper level ACP name
Address	Device address
Name	Device name to be displayed in the system <ul style="list-style-type: none"> <li>For batch add, it is displayed as "Name_device address" form</li> </ul>
Model	Product model name
AHU type	Select AHU type
Additional function	Select function to add
Room Temp	Between air supply or ventilation, selecte the desired indoor temperature setting standard
Add All	When checkboxes are selected, all selected devices are added



## Chiller

Select device type to add to AC Smart

ODU     HRV     AHHP     AHU     Chiller  
 DOKIT     DI     DO     EXP.DD

---

ACP name

Address

Name

Type

---

Add all

Category	Description
ACP name	The corresponding device's upper level ACP name
Address	Device address
Name	Device name to be displayed in the system <ul style="list-style-type: none"> <li>For batch add, it is displayed as "Name_device address" form</li> </ul>
Type	Select chiller type
Add All	When checkboxes are selected, all selected devices are added



DOKIT

Category	Description
ACP name	The corresponding device's upper level ACP name
Address	Device address
Name	Device name to be displayed in the system <ul style="list-style-type: none"><li>For batch add, it is displayed as "Name_device address" form</li></ul>
Add All	When checkboxes are selected, all selected devices are added



DI/DO

Category	Description
ACP name	The corresponding device's upper level ACP name
Address	Device address
Name	Device name to be displayed in the system <ul style="list-style-type: none"><li>For batch add, it is displayed as "Name_device address" form</li></ul>
Add All	When checkboxes are selected, all selected devices are added



Exp.I/O

Select device type to add to AC Smart

ODU     
  HRV     
  AWHP     
  AHU     
  Chiller  
 DOKIT     
  DI     
  DO     
 EXP. I/O

---

ACP name:

Type:

Address:

Name:

---

Add all

Category	Description
ACP name	The corresponding device's upper level ACP name
Type	Device type
Address	Device address
Name	Device name to be displayed in the system <ul style="list-style-type: none"> <li>For batch add, it is displayed as "Name_device address" form</li> </ul>
Add All	When checkboxes are selected, all selected devices are added



## Exp.I/O's lower level setting

AO[01/02]
Delete Apply

Whether used  Use  Do not use

ACP name

Device type

Address

Name

Icon

I/O Type  VOL

Signal boundary

Usage  
 Temperature  Humidity  Opening  Water level  Operation ratio  Concentration  Pressure

Unit symbol  
 %  °

Display boundary  
Min  Max

Correction value

Category	Description
Whether used	Select whether to use the device
ACP name	The corresponding device's upper level ACP name
Device type	Device type
Address	Device address
Name	Device name
Icon	Select icon type
I/O type	Select I/O type <ul style="list-style-type: none"> <li>• AO: VOL(0~10V, 2~10V)</li> <li>• UI: BI, VOL(0~10V, 2~10V), CUR(0~20mA, 4~20mA), PT1000, NTC10K, NI1000</li> <li>• DO: BI</li> <li>• DI: BI</li> </ul>
Signal boundary	Select signal boundary
Usage	Select usage of the device (Usage selection is different according to I/O type) <ul style="list-style-type: none"> <li>• Status information: On/Off, short/Open, Warning/Normal, Close/Open, On/Off, Occupied/Unoccupied, 1/0</li> <li>• Value information: Temperature, Humidity, Opening, Water level, Operation ratio, Concentration, Pressure</li> </ul>
Unit Symbol	Select unit symbol Flexibly changed according to the usage selection
Display boundary	Max./Min. value input
Correction value	Correction value input

## Group Setting

You can add/delete management group created according to user's usage.

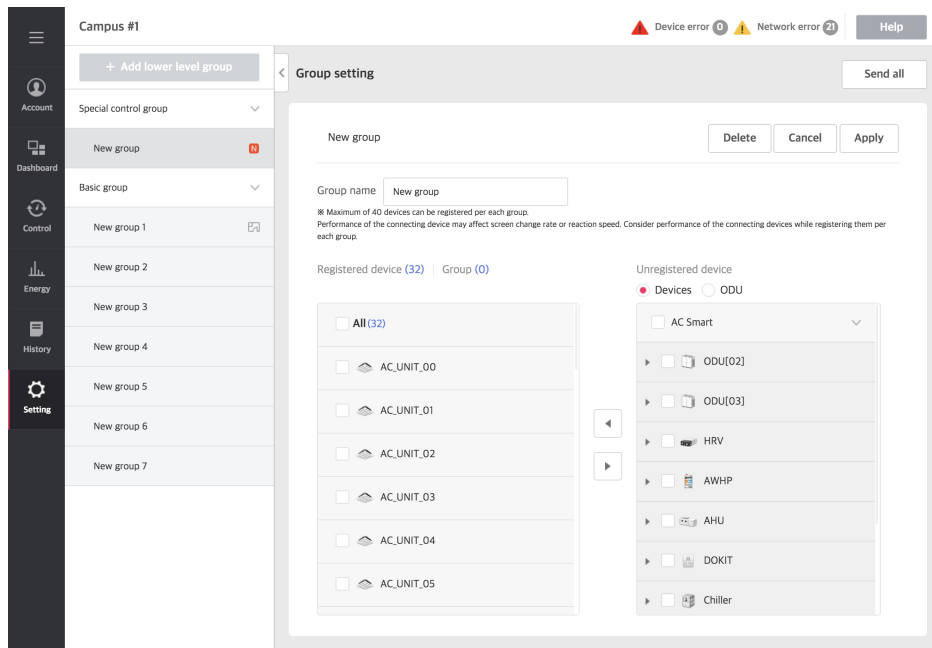

## Add Group

You can add new group.

1. In the left menu tab, click **[Setting] > [Group Setting]** menu.
  - Group setting screen is displayed.
2. Select group and click **[+ Add lower level group]** button.
  - New group is created.
3. Input group name in the group name input field.
4. To register new device in the device list, in the unregistered device list, click the checkbox of the device to register and click **[◀]** button.
5. To save the set contents, click **[Apply]** button.
6. To complete group addition, click **[Send All]** button.

## Group edit

You can edit group.

1. In the left menu tab, click **[Setting] > [Group Setting]** menu.
  - Group setting screen is displayed.
2. In group list, select group to edit.
3. Edit group information.
4. To save the set contents, click **[Apply]** button.
5. To complete group addition, click **[Send All]** button.

## Delete group

In the group list, you can select and delete the desired group.

1. In the left menu tab, click **[Setting] > [Group Setting]** menu.
  - Group setting screen is displayed.

- In the group list, select the group to delete and click **[Delete]** button.
2. When Delete group popup window appears, click **[Yes]** button.
    - The selected group is deleted.
  3. To complete group deletion, click **[Send All]** button.



## System Setting

You can change the system setting.

1. In the left menu tab, click **[Setting] > [System Setting]** menu.
  - System setting screen is displayed.
2. Set the system.

### System setting

Cancel Apply

Title	<input type="text" value="Campus #1"/>
Language	<input type="text" value="English"/> ▼
Day format	<input type="text" value="MM-DD-YYYY"/> ▼
Time format	<input type="text" value="24 Time"/> ▼
Temperature	<input type="text" value="Celsius 1°C"/> ▼
Set the lowest temperature for COOL/HEAT	<input type="text" value="18 °C"/> ▼
<small>Applies only when the mode is COOL/HEAT.</small>	
Use energy navigation	<input checked="" type="radio"/> Set <input type="radio"/> Clear
Power usage statistics base date	<input type="text" value="1Day"/> ▼
Use 'Drawing'	<input checked="" type="radio"/> Set <input type="radio"/> Clear
Use CO <sub>2</sub> concentration widget	<input checked="" type="radio"/> Set <input type="radio"/> Clear
Use comfort widget	<input type="radio"/> Set <input checked="" type="radio"/> Clear
Use finedust widget	<input type="radio"/> Set <input checked="" type="radio"/> Clear
Apply damper opening formula	<input checked="" type="radio"/> Set <input type="radio"/> Clear
Comfort - Season setting	<input checked="" type="radio"/> Summer <input type="radio"/> Winter
Energy target management	<input type="text" value="Set"/>
Schedule exception date setting	<input type="text" value="Set"/>
To register schedule exception device	<input type="text" value="Set"/>

Back up Setting Data    Backup    Apply backup file

System restart    Restart

Send out installation status    Send out

System time    04-16-2018 11:44

Date setting    04-16-2018 ▼

Time setting    11    43

If you change the system date or time, you will be logged out and need to log on again.

Daylight Saving Time     Set     Clear

Start date    1Month ▼    1st ▼    Mon.Days ▼    1:00 ▼

End date    1Month ▼    1st ▼    Mon.Days ▼    1:00 ▼

Version    Ver.1.30.3.C+  
Copyright © 2015 - 2018 LG Electronics Inc. All right reserved.

Category	Description
Title	Input the desired name in the input field
Language	Press [▼] button to select the desired language (한국어/ English/ Español/ Português/ Italiano/ Deutsch/ Türkçe/ Polski/ русский/ Français/ 中文/ Čeština)
Day format	You can set the Day format. (YYYY-MM-DD / MM-DD-YYYY / DD-MM-YYYY)
Time format	You can set the Time format. (12 / 24)
Temperature	Press [▼] button to select the desired control temperature unit (Celsius 0.5°C / Celsius 1°C / Fahrenheit 1°F)
Set the lowest temperature for COOL/HEAT	Press [▼] button to select the desired cooling/heating lower limit temperature (16°C / 18°C)
Use Energy Navigation	Select whether to use Energy Navigation
Energy navigation base date	Press [▼] button to select the desired date <ul style="list-style-type: none"> <li>Energy navigation monthly power usage amount base date setting</li> <li>Calculate the days to the one day before in the next month from the set date</li> </ul>
Use 'Drawing'	Select whether to use 'Drawing'
Use CO <sub>2</sub> concentration widget	When it is set, dash board CO <sub>2</sub> concentration widget is activated
Use pleasantness widget	When it is set, dash board pleasantness widget is activated
Use fine dust widget	When it is set, dash board fine dust widget is activated
Apply damper opening formula	<ul style="list-style-type: none"> <li>Select whether to apply damper opening formula</li> <li>When damper opening is set, it operates at OA=EA and OA+MIX=90</li> </ul>
Pleasantness season setting	Winter/summer setting for pleasantness calculation When summer is set, pleasantness range is formed in lower temperature
Energy target amount setting	Target energy amount setting for energy(Dashboard) management
Schedule exception date setting	Set exception date for schedule setting
To register schedule exception device	Set the device to except in schedule setting in advance
Setting data backup	<ul style="list-style-type: none"> <li>Backup: backup of data to PC (In AC Smart 5 Device, it is stored in USB.)</li> <li>Backup file application: overwrite data with backup file stored in PC</li> </ul>
System restart	Restart the entire system
Send out installation status	Save installation status to PC (In AC Smart 5 Device, it is stored in USB.)

System time	Check system time
Date setting	You can set the date.
Time setting	You can set the time.
Daylight saving time setting	Daylight saving time (summer time) start and end date Set/Clear
Version	You can check the version.

3. When setting is completed, click **[Apply]** button.

- Setting the exception date
- Delete exception date
- Register schedule exception device

**Note**

- **When system time or date is changed, it can be logged out, and you need to log in again.**

## Network Setting

You can set or change network information.

- In the left menu tab, click **[Setting] > [Network Setting]** menu.
  - Network setting screen is displayed.
- Set the network information.

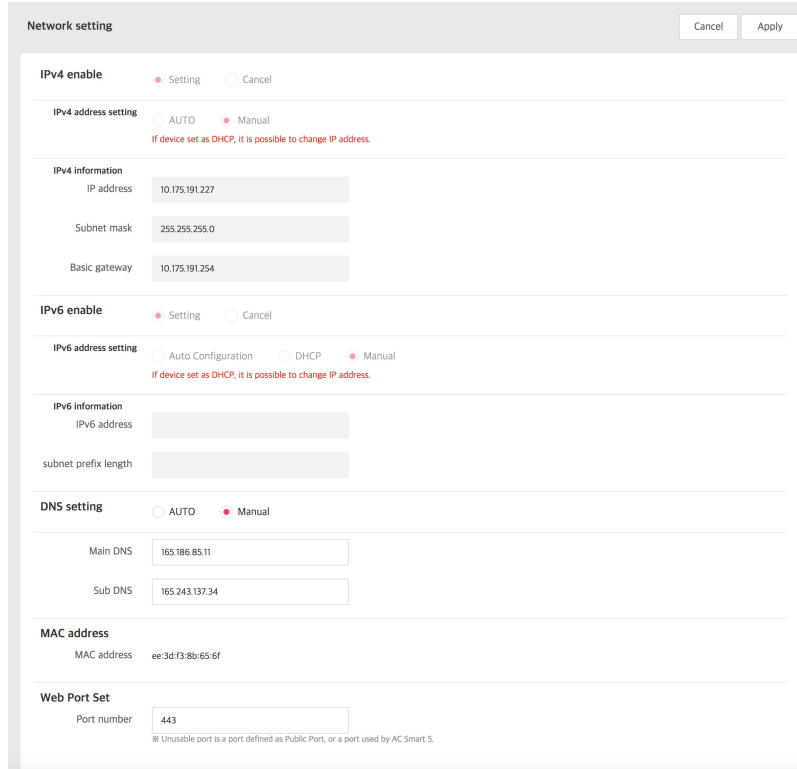

Category	Description
IPv4 enable	IPv4 usage address <b>Set/Clear</b>
IPv4 address setting	Check IPv4 address setting <b>DHCP/Manual</b>
IPv4 information	Check IPv4 address
IPv6 enable	IPv6 usage address <b>Set/Clear</b>
IPv6 address setting	Check IPv6 address setting <b>Auto Configuration/DHCP/manual</b>
IPv6 information	Check IPv6 address
DNS setting	<b>[AUTO]</b> : Automatically sets main DNS and secondary DNS <b>[Manual]</b> : User sets main DNS and secondary DNS
MAC address	Check MAC address
HTTP Port setting	Port setting (range: 2~65535)

### Note

**Network setting can be set in Device, and only some settings may be changed in Web.**

- When setting is completed, click **[Apply]** button.

## Error Notice Setting

You can set or change error notice.

1. In the left menu tab, click **[Setting] > [Error Notice Setting]** menu.
  - Error notice setting screen is displayed.
2. Set the error notice.

**Error notice setting**

Cancel Apply

e-mail usage setting  Set  Clear

e-mail title

Receiving e-mail address  Add address

Sending cycle when error occurs  ▼

Automatic daily error-notification mail  Set  Clear

Category	Description
e-mail usage setting	Selection of set/clear of whether to send the error occurred device's address and error No. through e-mail
e-mail title	e-mail title setting
Receiving e-mail address	Input receiving e-mail address
Sending cycle when error occurs	Set transmission cycle in case of error (10/20/30/40/50/60 min.)
Automatic daily error-notification mail	Set to send mail at 0:00 every day even if error does not occur

3. To save the set contents, click **[Apply]** button.

### Note

**Before e-mail usage setting, check the following categories.**

- **[Setting] > [Network setting]'s DNS server shall be set.**
- **[Setting] > [Administrator setting]'s mail server and sending e-mail shall be set.**



## Administrator Setting

You can set or change the user management environment when the user logs in with manager authority.

1. In the left menu tab, click **[Setting] > [Administrator Setting]** menu.

- Administrator setting screen is displayed. You can change the manager information or set the system usage environment.

### Administrator setting

Cancel Apply

#### Set password

Current password

New password

Verify new password

#### Set receiving e-mail

E-mail

※When you add 'new InterLocking', if you select Send e-mail with output condition You can receive InterLocking execution information to the set manager e-mail.

#### Set mail server

Connection test

SMTP Server

Port

Scope 2~65535

※ While editing the email server settings or the incoming/outgoing email settings, you cannot perform [Test Connection]. Click the [Apply] button to save the changes, and then try it again.

※ To perform [Test Connection] in the email server settings or to receive/send emails through the central controller, you first need to set the [Network setting] > [DNS setting].

#### Set sending e-mail

ID

Password

※ You need to save the mail server (SMTP server) ID and password that connection test succeeded to send e-mail through mail server.

**Set menu** Dash board Control Device control Schedule control InterLocking Time limit control Energy Energy Usage Energy Navigation Peak demand control History Operation history Energy navigation history Operation trend Cycle Set Installing Group setting System setting Network setting Error notice setting Administrator setting Additional user setting Screen Setting Advance Setting TMS Setting BACnet/Modbus Setting

Category	Description
Set password	Set the password to use during login <ul style="list-style-type: none"> <li>• Current password: Input password used currently for login</li> <li>• New password: Input new password</li> <li>• New password verification: Input the same new password one more time</li> </ul>
Set receiving e-mail	Input e-mail address
Set Mail server	Manager mail server setting <ul style="list-style-type: none"> <li>• SMTP server: Input SMTP server address</li> <li>• Port: Input port No.</li> <li>• Connection test: Input mail account test (network shall be connected)</li> </ul>
Set sending e-mail	<ul style="list-style-type: none"> <li>• ID: Input user ID</li> <li>• Password: Input user password</li> </ul>
Set Menu	Click checkbox to select the desired manager menu (you can select multiple) <ul style="list-style-type: none"> <li>• Dashboard</li> <li>• Control: device control, schedule control, InterLocking, Time limit control</li> <li>• Energy: Energy usage, Energy Navigation, Peak demand control</li> <li>• History: operation history, Energy Navigation history, operation trend, cycle</li> <li>• Setting: Installing, Group setting, System setting, Network setting, Error notice setting, Administrator setting, Additional user setting, Screen Setting, Advance Setting, TMS Setting, BACnetModbus Setting</li> </ul>

2. To save the set contents, click **[Apply]** button.

## Additional User Setting

You can manage the additional user list when you login with manager authority.

- In the left menu tab, click **[Setting] > [Additional User Setting]** menu.
  - Additional user setting screen is displayed. You can add user or edit or delete registered user information.

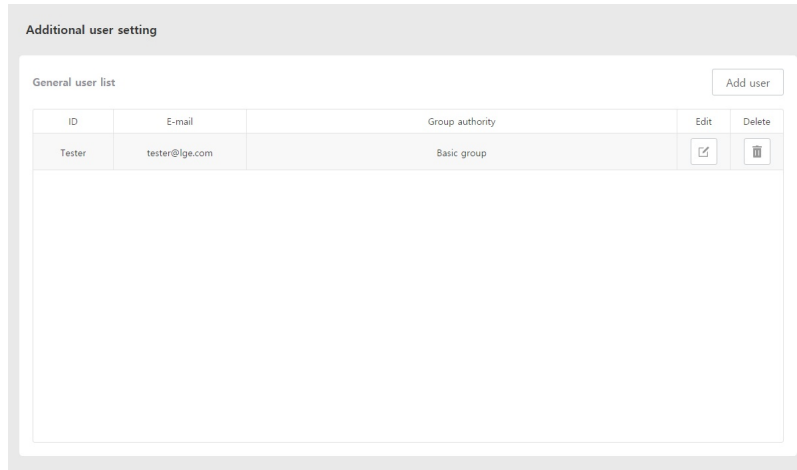

## Add User

You can add secondary manager and general user.

- In the left menu tab, click **[Setting] > [Additional User Setting]** menu.
  - Additional user setting screen is displayed.
- Click **[Add User]** button.
  - Add user screen is displayed.
- Set each category.

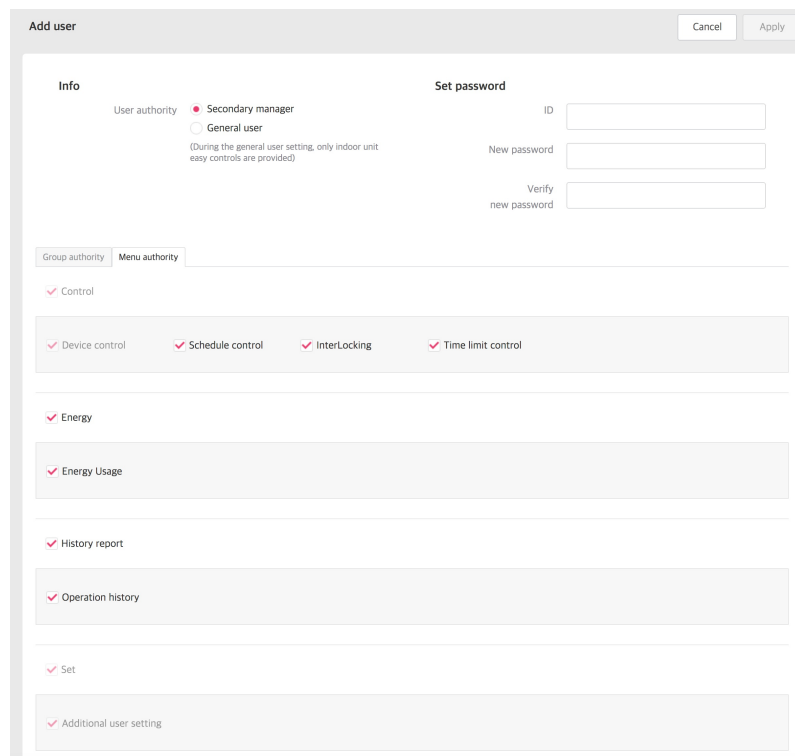

Category	Description
	<b>[User authority]</b>

Info	<ul style="list-style-type: none"> <li>• Secondary manager: Provides authority assigned menu</li> <li>• General user: Provides only indoor unit simple controls</li> </ul>
Set password	<p><b>[ID]</b>: input ID to use</p> <p><b>[password]</b>: input password to use</p> <p><b>[Verify password]</b>: input password to use again</p>
Group Authority	<p>Assign additional user's group authority</p> <ul style="list-style-type: none"> <li>• When group is selected, only the corresponding group can control</li> </ul>
Menu Authority	<p>Assign menu authority used by additional user</p> <ul style="list-style-type: none"> <li>• For general user, only <b>[Control]-[Device Control], [Setting]-[Additional User Setting]</b> menu authorities are assigned</li> </ul>

4. When setting is completed, click **[Apply]** button.

## Delete User

You can delete registered user.

1. In the left menu tab, click **[Setting] > [Additional User Setting]** menu.

- Additional user setting screen is displayed.

2. Click **[Delete]** button of the user to delete.

- Delete user screen is displayed.

3. Click **[Yes]** button



## Screen Setting

You can set product screen related usage environment.

1. In the left side menu tab, click **[Setting]** > **[Screen Setting]** menu.
  - Screen setting screen is displayed.
2. Set screen information.

Screen Setting

Cancel Apply

Use Turn off Monitor  Set  Clear

Time before Turning off the Monitor (Minute) 10Min. ▾

Category	Description
Screen saver setting	<ul style="list-style-type: none"><li>• Monitor OFF usage: use of monitor power OFF function <b>Set/Clear</b></li><li>• Monitor OFF standby time (min.): set standby time until monitor power OFF (10/20/30/40/50/60 min.)</li></ul>

3. When setting is completed, click **[Apply]** button.

## Advance Setting

You can set functions required for device operation.

1. In the left side menu tab, click **[Setting] > [Advance Setting]** menu.

- Advance Setting screen is displayed.

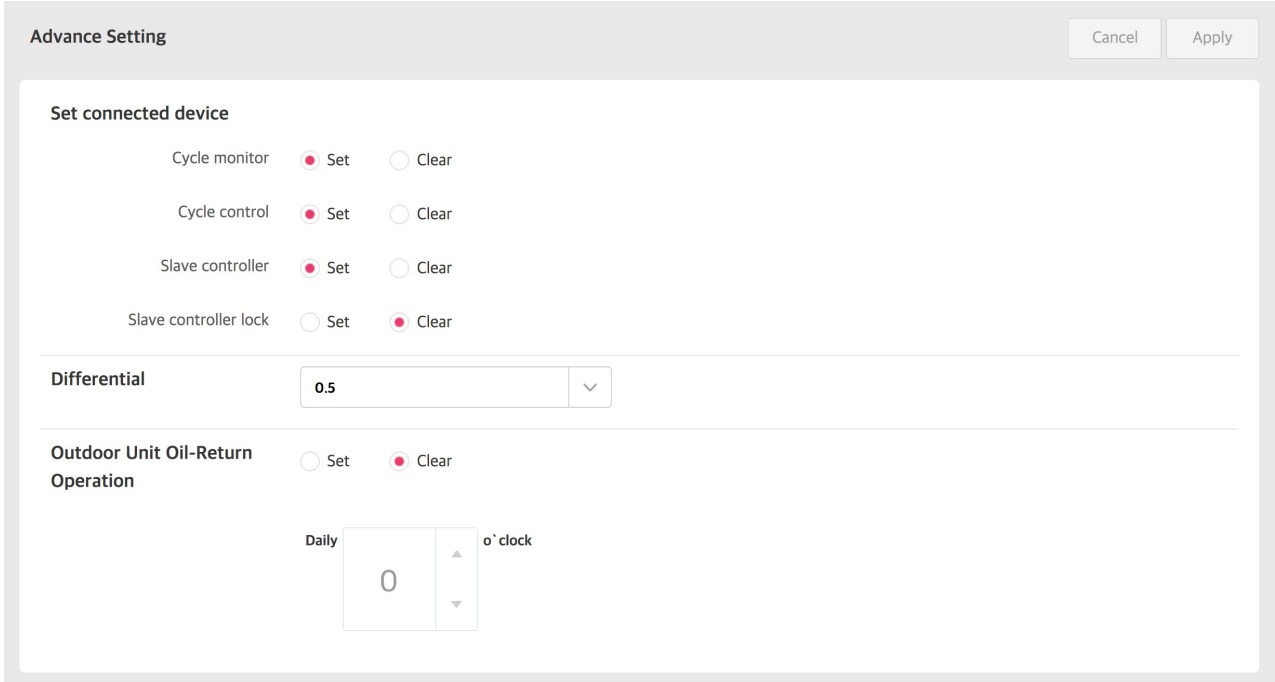

Category	Description
Set connected device	<ul style="list-style-type: none"> <li>• Outdoor unit cycle monitoring: set whether to use cycle information monitoring</li> <li>• Outdoor unit cycle control: set whether to run cycle control</li> <li>• Slave controller: set whether slave controller control is possible</li> <li>• Slave controller lock: set whether slave controller control is possible for indoor unit with all lock set (Use: Slave controller control is not possible)</li> </ul>
Differential	Press <b>[▼]</b> button to set temperature difference for automatic switching operation
Outdoor Unit Oil-Return Operation	Set whether to run Outdoor Unit Oil-Return Operation Press <b>[▲]/[▼]</b> button to set Outdoor Unit Oil-Return Operation time

2. To save the set contents, click **[Apply]** button.



## TMS Setting

You can set remote service that can manage the system remotely.

1. In the left side menu tab, click **[Setting]** > **[TMS Setting]** menu.

- TMS Setting screen is displayed.

**TMS Setting**

Cancel Apply

---

**TMS configuration**      Set     Clear

---

**Information TMS service**

TMS server address   

TMS server port       

Update Cycle (Second)     ▼

---

**Site information**

Site address           

Site name               

Site code

Category	Description
TMS configuration	Set whether to use remote service
Information TMS service	<ul style="list-style-type: none"> <li>• Service server address: input remote service server address</li> <li>• Service server port: input remote service server port number</li> <li>• Update cycle (sec.): Press [▼] button to select remote service update cycle 10 / 30 / 60 / 90 / 120 seconds</li> </ul>
Site information	<ul style="list-style-type: none"> <li>• Site address: remote site address input</li> <li>• Site name: input remote site name</li> <li>• Site code: Press <b>[Request a site code]</b> button to input site code</li> </ul>

2. To save the set contents, click **[Apply]** button.



## BACnet/Modbus setting

You can change BACnet/Modbus setting

- In the left side menu tab, click **[Setting] > [Screen Setting]** menu.
  - Screen setting screen is displayed.
- Set screen information.

**BACnet/Modbus Setting**
Cancel Apply

---

**BACnet enable**  Set  Clear

---

**Temperature Unit Setting**  °C  °F

---

**Device ID Setting**

---

**Network Number Setting**

---

**Register as Foreign Device**  Set  Clear

IP

Port

TTL

---

**Only Monitoring Setting**  Set  Clear

---

**BACnet Port Setting**

---

**BACnet Type Setting**  A Type  B Type

---

**Time sync setting**  Set  Clear

---

**Modbus TCP enable**  Set  Clear

---

**Vnet Number Setting**

Category	Description
BACnet enable	BACnet enable <b>Set/Clear</b>
Temperature unit setting	Select temperature unit type (°C/°F)
Device ID setting	Device ID setting to designate Device Instance Number <ul style="list-style-type: none"> <li>Air conditioner: Device ID</li> <li>Ventilation: Device ID + 1</li> <li>AHU: Device ID + 2</li> <li>Outdoor unit cycle information: Device ID + 3</li> <li>System boiler: Device ID + 4</li> </ul>

	<ul style="list-style-type: none"> <li>• Normal : Device ID + 5</li> </ul>
Network Number Setting	Network Number Setting
Register as Foreign Device	Foreign Device <b>Set/Clear</b>
Only Monitoring setting	Only Monitoring <b>Set/Clear</b>
BACnet Port setting	BACnet Port setting
BACnet Type setting	BACnet Type selection (A/B)
Time sync setting	Time sync setting <b>Set/Clear</b>
Modbus TCP enable	Modbus TCP enable <b>Set/Clear</b>
Vnet Number setting	Vnet Number setting to use Modbus TCP function Set Vnet Number value operates as Modbus TCP's Slave ID Address

3. When setting is completed, click **[Apply]** button.



## Usage (Mobile, Tablet)

- LogIn / LogOut
- Dashboard
- Device Control
- Schedule Control

You can access to the product with IP address in internet address window to use various central control functions.

## Note

- **Chrome browser is recommended for web control.**
- **For access to web, IP address needs to be set.**

## Login

Login method is as follows.

1. Please input IP address of the product in the internet address window.
2. Input ID and password in the login window and click **[Login]** button.

## LogOut

Logout method is as follows.

1. In the menu, click **[LogOut]** button.

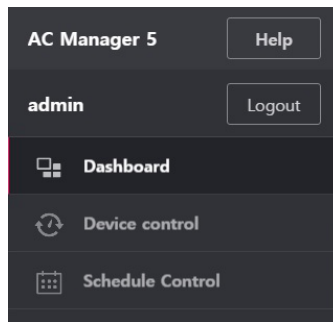

You can check the current operation status and energy usage trend of the equipment installed in the product.

## Operation status

It describes the dash board's current operation status tab composition and functions.

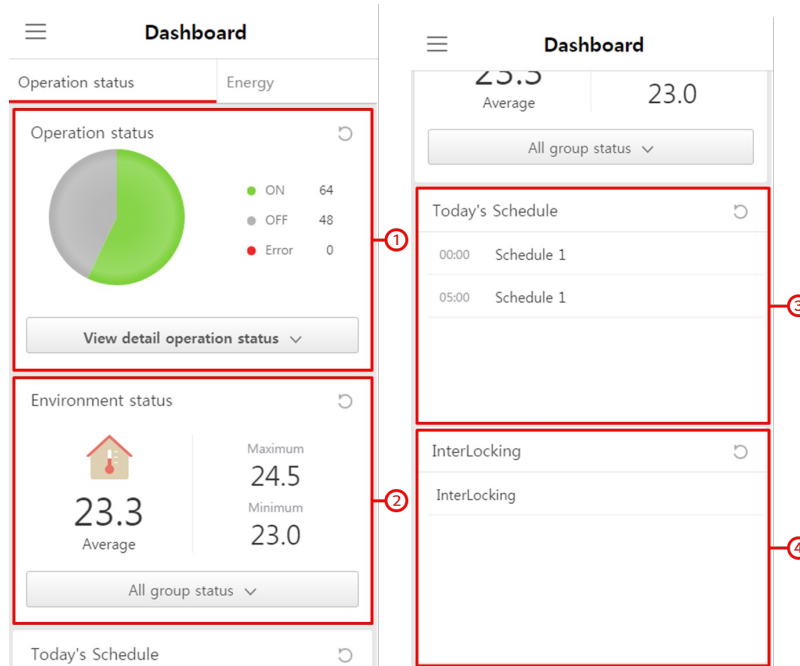

No.	Category	Contents
①	Operation status	Check operation status (start/stop/error) of the equipment installed in the product [group] <ul style="list-style-type: none"> <li>• Checking of operation status of each management group designated by user</li> </ul> [device] <ul style="list-style-type: none"> <li>• Checking of operation status of each device</li> </ul>
②	Environment status	Checking of average indoor temperature, Max./Min. indoor temperature and group
③	Today's Schedule	Checking today's schedule list
④	InterLocking	Checking of InterLocking list

## Energy

It describes the dash board's energy tab composition and functions.

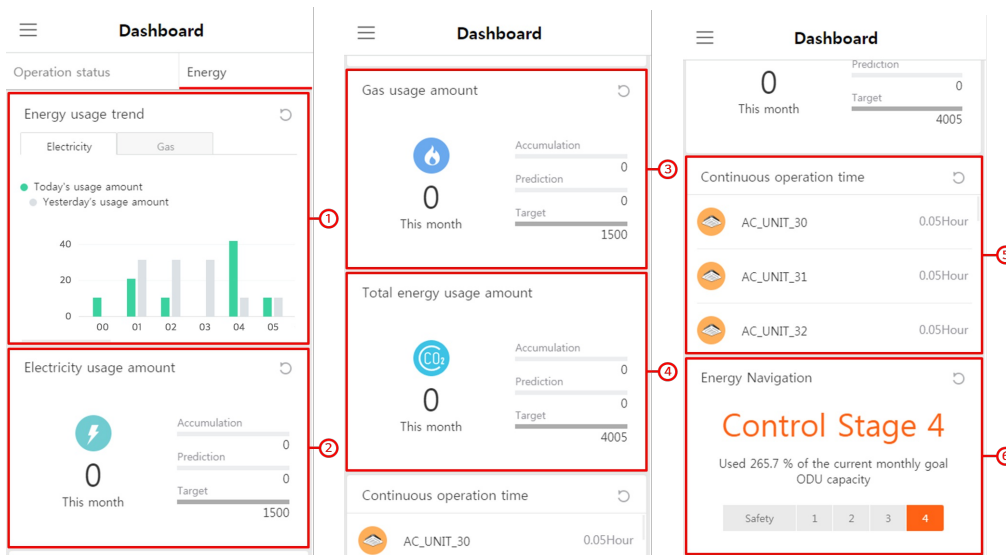

No.	Category	Contents
①	Energy usage trend	Checking of daily, monthly, and yearly trend of electricity/gas usage amount
②	Electricity usage amount	Checking of electricity usage amount accumulation, forecast, and goal
③	Gas usage amount	Checking of gas usage amount accumulation, forecast, and goal
④	Total energy usage amount	Checking of total energy usage amount accumulation, forecast, and goal
⑤	Continuous operation time	Checking of continuous operation time rank of indoor unit
⑥	Energy Navigation	Check energy navigation status

## Environment status

It describes the composition and functions of dash board environment status tab

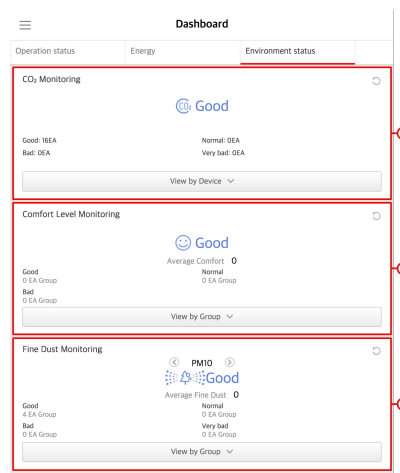

No.	Category	Contents
①	CO <sub>2</sub> monitoring	Check CO <sub>2</sub> status of registered ventilation
②	Comfort Level Monitoring	Check registered indoor unit's pleasantness status
③	Fine dust monitoring	Check registered indoor unit's fine dust status Fine dust is classified to PM10, PM2.5, and PM1.0, and it indicates each status and concentration



## Device Control

It describes the method to control the device and to monitor the device status.

### [Screen]

- Screen Structure and Function

### [Control Window]

- Control of Each Device
- Device Information

## Screen Structure and Function

1. In the left menu tab, click **[Control]** > **[Device Control]** menu.

- The device control screen is displayed.



No.	Category	Contents
①	Group Information	Group name and group location
②	Filtering	Device category filtering
③	Multi-select	Select multiple devices when it is clicked
④	Device section	Check the information of the devices set in the group

## Control of Each Device

When a device is selected in the device section, control window is created as in the following screen. Through the control window, you can control the selected device.

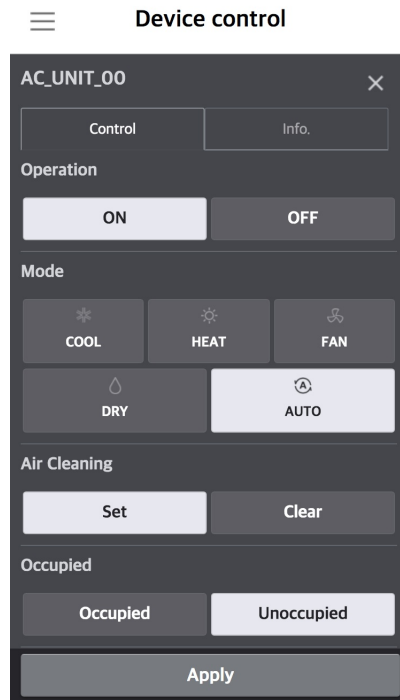

### Note

- The detail control boundary for each device may be different from the actual device, so make sure to refer to the corresponding device's manual.
- Chiller interface is an optional function, and you need to separately purchase the option for chiller interface.
- ACS I/O devices may have different control tool name, unit, upper limit, lower limit, etc. according to the setting.

## Detail controls for each device

- Outdoor Unit
- IDU
  - IDU (2Set)
- HRV
- DXHRV
- AWHP
- AHU
- Scroll chiller
- Screw chiller
- Turbo chiller
- Absorption Chiller
- DOKIT
- DO
- AO

**Outdoor Unit**

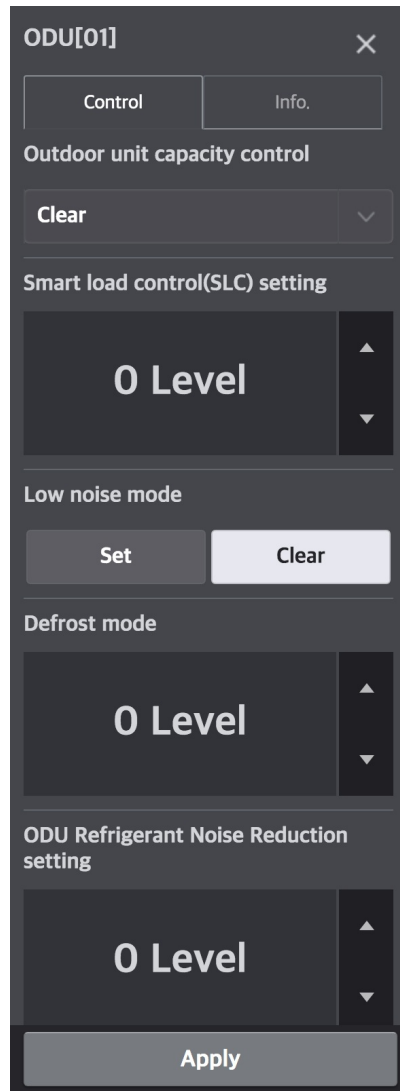

Category	Contents
Outdoor unit capacity control	• Press [▼] button to set operation rate (%)
Smart load control function	• Press [▲]/[▼] button to set smart load control stage (0stage, 1stage, 2stage, 3stage, 4stage)
Low noise operation	• [Set/Clear] button: outdoor unit low noise operation Set/Clear
Defrost mode	• Press [▲]/[▼] button to set defrost mode stage (0stage, 1stage, 2stage, 3stage)
ODU Refrigerant Noise Reduction setting	• Press [▲]/[▼] button to set outdoor unit refrigerant noise reduction stage (0stage, 1stage, 2stage)

**Note**

In the central controller, if 'outdoor unit low noise operation' is used, in the installed indoor unit's remote controller, you need to set [Installer setting] > [Low noise mode] to 'ODU'. (Default value 'ODU')



Category	Contents
Operation	<ul style="list-style-type: none"> <li>• <b>[ON]</b> button: starts the device operation</li> <li>• <b>[OFF]</b> button: Stops the device operation</li> </ul>
Mode	<ul style="list-style-type: none"> <li>• <b>[COOL]</b> button: Switches to cooling mode</li> <li>• <b>[HEAT]</b> button: Switches to heating mode</li> <li>• <b>[FAN]</b> button: Air purification operation. When FAN is selected, set temperature is not applied to the device</li> <li>• <b>[DRY]</b> button: Removes moisture during rainy season or when humidity is high. When DRY is selected, set temperature is not applied to the device</li> <li>• <b>[AUTO]</b> button: Switches to automatic mode</li> </ul>
Air cleaning	<p>Air cleaning control only for air cleaning function supporting indoor unit</p> <ul style="list-style-type: none"> <li>• Air cleaning single operation <ol style="list-style-type: none"> <li>1) In indoor unit stop state, in case of air cleaning <b>[Set]</b>, air cleaning single operation with wind only (automatic wind) (During air cleaning single operation, mode lock and wind amount lock are not checked)</li> <li>2) During air cleaning single operation, in case of operation <b>[OFF]</b> or air cleaning <b>[Clear]</b>, air cleaning is cancelled to previous mode and previous wind amount (But, in case of mode or wind amount control together, control is done with controlled mode and wind amount)</li> </ol> </li> <li>• Air cleaning additional operation <ol style="list-style-type: none"> <li>1) In indoor unit stop state, in case of operation status <b>[ON]</b> and air cleaning <b>[Set]</b>, in current mode, air cleaning additional operation</li> <li>2) In indoor unit operation state, in case of air cleaning <b>[Set]</b>, in current mode, air cleaning additional operation</li> <li>3) During air cleaning additional operation, in case of operation <b>[OFF]</b>, operation stops</li> <li>4) During air cleaning additional operation, in case of air cleaning <b>[Clear]</b>, air cleaning is cancelled</li> </ol> </li> </ul>

Set temperature	Press <b>[▲]/[▼]</b> button to set the desired temperature
Fan speed	Wind strength setting <ul style="list-style-type: none"> <li>• <b>[LOW]</b> button: Set the fan speed to slow</li> <li>• <b>[MED]</b> button: Set the fan speed to normal</li> <li>• <b>[HIGH]</b> button: Set the fan speed to fast</li> <li>• <b>[AUTO]</b> button: <b>[LOW]-[MED]-[HIGH]</b> automatic switching</li> </ul>
Swing	<ul style="list-style-type: none"> <li>• <b>[Set/Clear]</b> button: Set/Clear the Swing function</li> </ul>
Set temp range	When user set the desired temperature individually, the desired temperature outside the designated temperature boundary cannot be set
Human detection mode - ON/OFF power saving	Only for human detection mode - supporting indoor unit, human detection mode - control <ul style="list-style-type: none"> <li>• <b>[Set/Clear]</b> button: human detection mode - ON/OFF power saving Set/Clear</li> </ul>
Human detection mode - Temperature power saving	Only for human detection mode - supporting indoor unit, human detection mode - control <ul style="list-style-type: none"> <li>• <b>[Set/Clear]</b> button: human detection mode - temperature power saving Set/Clear</li> </ul>
Human detection mode - Unoccupied time setting(minute)	Only for human detection mode - supporting indoor unit, human detection mode - control Set empty decision time to 5, 10, 15, 30, 60, or 90 min.
Human detection mode - Direct wind	Only for human detection mode - supporting indoor unit, human detection mode - control <ul style="list-style-type: none"> <li>• <b>[Set/Clear]</b> button: human detection mode - direct wind Set/Clear</li> </ul>
Human detection mode - Indirect wind	Only for human detection mode - supporting indoor unit, human detection mode - control <ul style="list-style-type: none"> <li>• <b>[Set/Clear]</b> button: human detection mode - indirect wind Set/Clear</li> </ul>
Comfortable Power Saving	<ul style="list-style-type: none"> <li>• <b>[Set/Clear]</b> button: Comfortable Power Saving function Set/Clear</li> <li>• You can press <b>[▲]/[▼]</b> button to set stage</li> </ul> Only when indoor unit is in cooling operation, Comfortable Power Saving control is possible
Filter replacement alarm	<ul style="list-style-type: none"> <li>• <b>[Clear]</b> button: in case of filter replacement alarm, it cancels filter replacement alarm</li> </ul>
HardLock	<ul style="list-style-type: none"> <li>• <b>[Set/Clear]</b> button: Set/clear HardLock so that user cannot control any function with individual remote controller</li> </ul>
Mode lock	<ul style="list-style-type: none"> <li>• <b>[Set/Clear]</b> button: Set/clear lock so that user cannot control mode setting with individual remote controller</li> </ul>
Fan lock	<ul style="list-style-type: none"> <li>• <b>[Set/Clear]</b> button: Set/clear lock so that user cannot control Fan speed setting with individual remote controller</li> </ul>
TempLock	<ul style="list-style-type: none"> <li>• <b>[Set/Clear]</b> button: Set/clear lock so that user cannot control temperature setting with individual remote controller</li> </ul>
Auto change over(Occupied)	It is a function to automatically switch to cooling operation if indoor temperature exceeds upper limit temperature, to heating operation if it is less than lower limit temperature, and to wind only operation if it is between upper limit temperature and lower limit temperature (supported only in outdoor unit with both cooling/heating) <ul style="list-style-type: none"> <li>• <b>[Set/Clear]</b> button: Set/clear Auto change over(Occupied)</li> </ul>
Lower /Upper temp.	Auto change over(Occupied)'s lower limit temperature and upper limit temperature setting
Auto change over(Occupied) Fan speed	Select the Fan speed value to set in the indoor unit during Auto change over(Occupied) operation <ul style="list-style-type: none"> <li>• <b>[LOW]</b> button: Set the fan speed to slow</li> <li>• <b>[MED]</b> button: Set the fan speed to normal</li> <li>• <b>[HIGH]</b> button: Set the fan speed to fast</li> <li>• <b>[AUTO]</b> button: <b>[LOW]-[MED]-[HIGH]</b> automatic switching</li> </ul>
Setback(UnOccupied)	Function to maintain the temperature of the space where the device is installed in certain boundary (Only supported by cooling/heating simultaneous type outdoor unit) <ul style="list-style-type: none"> <li>• <b>[Set/Clear]</b> button: Set/clear the Setback(UnOccupied)</li> </ul>
Cool start	Press <b>[▲]/[▼]</b> button to set the cooling operation start temperature(21°C~40°C)
Heat start	Press <b>[▲]/[▼]</b> button to set the heating operation start temperature(1°C~20°C)

## IDU (2Set)

When 2Set function supporting outdoor unit/indoor unit/remote controller are used and in **[Setting] > [Installing]**, if ACP's 2Set automatic mode is selected as **IDU**, indoor unit 2Set control window is generated on the right side as in the following screen.



Category	Contents
Operation	<ul style="list-style-type: none"> <li>• <b>[ON]</b> button: starts the device operation</li> <li>• <b>[OFF]</b> button: Stops the device operation</li> </ul>
Mode	<ul style="list-style-type: none"> <li>• <b>[COOL]</b> button: Switches to cooling mode</li> <li>• <b>[HEAT]</b> button: Switches to heating mode</li> <li>• <b>[FAN]</b> button: Air purification operation. When FAN is selected, set temperature is not applied to the device</li> <li>• <b>[DRY]</b> button: Removes moisture during rainy season or when humidity is high. When DRY is selected, set temperature is not applied to the device</li> <li>• <b>[AUTO]</b> button: Switches to automatic mode</li> </ul>
Air cleaning	<p>Air cleaning control only for air cleaning function supporting indoor unit</p> <ul style="list-style-type: none"> <li>• Air cleaning single operation                             <ol style="list-style-type: none"> <li>1) In indoor unit stop state, in case of air cleaning <b>[Set]</b>, air cleaning single operation with wind only (automatic wind) (During air cleaning single operation, mode lock and wind amount lock are not checked)</li> <li>2) During air cleaning single operation, in case of operation <b>[OFF]</b> or air cleaning <b>[Clear]</b>, air cleaning is cancelled to previous mode and previous wind amount (But, in case of mode or wind amount control together, control is done with controlled mode and wind amount)</li> </ol> </li> <li>• Air cleaning additional operation                             <ol style="list-style-type: none"> <li>1) In indoor unit stop state, in case of operation status <b>[ON]</b> and air cleaning <b>[Set]</b>, in current mode, air cleaning additional operation</li> <li>2) In indoor unit operation state, in case of air cleaning <b>[Set]</b>, in current mode, air cleaning additional operation</li> <li>3) During air cleaning additional operation, in case of operation <b>[OFF]</b>, operation stops</li> </ol> </li> </ul>

	4) During air cleaning additional operation, in case of air cleaning <b>[Clear]</b> , air cleaning is cancelled
Occupancy	Function to set the space with the corresponding indoor unit as occupied or empty <ul style="list-style-type: none"> <li>• <b>[Occupied]</b> button: occupied setting</li> <li>• <b>[Unoccupied]</b> button: empty setting</li> </ul>
Cooling set temperature	Press <b>[▲]/[▼]</b> button to set cooling set temperature
Heating setting temperature	Press <b>[▲]/[▼]</b> button to set heating set temperature
Cooling lower limit/upper limit temperature	Cooling lower limit temperature and upper limit temperature setting
Heating lower limit/upper limit temperature	Heating lower limit temperature and upper limit temperature setting
Fan speed	Wind strength setting <ul style="list-style-type: none"> <li>• <b>[LOW]</b> button: Set the fan speed to slow</li> <li>• <b>[MED]</b> button: Set the fan speed to normal</li> <li>• <b>[HIGH]</b> button: Set the fan speed to fast</li> <li>• <b>[AUTO]</b> button: <b>[LOW]-[MED]-[HIGH]</b> automatic switching</li> </ul>
Swing	<ul style="list-style-type: none"> <li>• <b>[Set/Clear]</b> button: Set/Clear the Swing function</li> </ul>
Human detection mode - ON/OFF power saving	Only for human detection mode - supporting indoor unit, human detection mode - control <ul style="list-style-type: none"> <li>• <b>[Set/Clear]</b> button: human detection mode - ON/OFF power saving Set/Clear</li> </ul>
Human detection mode - Temperature power saving	Only for human detection mode - supporting indoor unit, human detection mode - control <ul style="list-style-type: none"> <li>• <b>[Set/Clear]</b> button: human detection mode - temperature power saving Set/Clear</li> </ul>
Human detection mode - Unoccupied time setting(minute)	Only for human detection mode - supporting indoor unit, human detection mode - control Set empty decision time to 5, 10, 15, 30, 60, or 90 min.
Human detection mode - Direct wind	Only for human detection mode - supporting indoor unit, human detection mode - control <ul style="list-style-type: none"> <li>• <b>[Set/Clear]</b> button: human detection mode - direct wind Set/Clear</li> </ul>
Human detection mode - Indirect wind	Only for human detection mode - supporting indoor unit, human detection mode - control <ul style="list-style-type: none"> <li>• <b>[Set/Clear]</b> button: human detection mode - indirect wind Set/Clear</li> </ul>
Comfortable Power Saving	<ul style="list-style-type: none"> <li>• <b>[Set/Clear]</b> button: Comfortable Power Saving function Set/Clear</li> <li>• You can press <b>[▲]/[▼]</b> button to set stage</li> </ul> <p>Only when indoor unit is in cooling operation, Comfortable Power Saving control is possible</p>
Filter replacement alarm	<ul style="list-style-type: none"> <li>• <b>[Clear]</b> button: in case of filter replacement alarm, it cancels filter replacement alarm</li> </ul>
HardLock	<ul style="list-style-type: none"> <li>• <b>[Set/Clear]</b> button: Set/clear HardLock so that user cannot control any function with individual remote controller</li> </ul>
Mode lock	<ul style="list-style-type: none"> <li>• <b>[Set/Clear]</b> button: Set/clear lock so that user cannot control mode setting with individual remote controller</li> </ul>
Fan lock	<ul style="list-style-type: none"> <li>• <b>[Set/Clear]</b> button: Set/clear lock so that user cannot control Fan speed setting with individual remote controller</li> </ul>
TempLock	<ul style="list-style-type: none"> <li>• <b>[Set/Clear]</b> button: Set/clear lock so that user cannot control temperature setting with individual remote controller</li> </ul>

## Note

### 2set automatic mode

- Only with 2Set automatic mode supporting indoor/outdoor air, the corresponding function can be used. (For whether each device supports 2Set, please refer to the manual of the corresponding device.)
- Override is a function that can be set from remote controller. For override function related contents, please refer to remote controller manual.
- In 2Set automatic mode, along with Auto icon, product's actual operation mode (cooling, heating) status is displayed.

### Occupancy

- If occupancy sensor is interlinked to indoor unit, setting from the central control has priority over the corresponding occupancy sensor. For occupancy sensor related contents, please refer to indoor unit or Dry Contact manual.
- When occupied setting is changed, automatically set cooling set temperature and heating set temperature are the most recently run schedule's cooling set temperature and heating set temperature, and if there is no previously run schedule, it is set to default value.

#### (Example)

09:00 - 12:00: occupied / cooling set temperature 27°C / heating set temperature 18°C

12:00 - 13:00: occupied / cooling set temperature 29°C / heating set temperature 16°C

13:00 - 15:00: occupied / cooling set temperature 26°C / heating set temperature 19°C

**If it is empty without schedule after 15:00, cooling set temperature is 29°C and heating set temperature is 16°C, and if it is occupied, cooling set temperature becomes 26°C and heating set temperature becomes 19°C.**



HRV

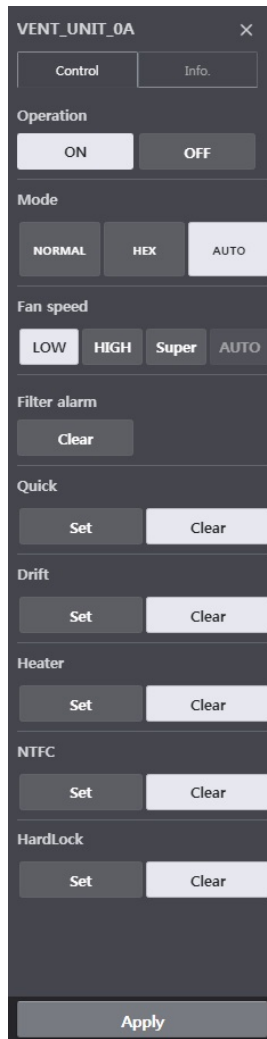

Category	Contents
Operation	<ul style="list-style-type: none"> <li>• <b>[ON]</b> button: starts the device operation</li> <li>• <b>[OFF]</b> button: Stops the device operation</li> </ul>
Mode	<ul style="list-style-type: none"> <li>• <b>[NORMAL]</b> button: Discharged air ventilates without going trough the electric heat exchanger</li> <li>• <b>[HEX]</b> button: Both air supply/discharge ventilates through the electric heat exchanger</li> <li>• <b>[AUTO]</b> button: Switches to four seasons mode</li> </ul>
Fan speed	<p>Wind strength setting</p> <ul style="list-style-type: none"> <li>• <b>[LOW]</b> button: Set the fan speed to slow</li> <li>• <b>[HIGH]</b> button: Set the fan speed to fast</li> <li>• <b>[SUPER]</b> button: Set the fan speed to Max. speed</li> <li>• <b>[AUTO]</b> button: <b>[LOW]-[HIGH]-[SUPER]</b> automatic switching <ul style="list-style-type: none"> <li>- User setting is impossible</li> <li>- When Drift/Quick is set, <b>[AUTO]</b> Fan speed is selected</li> <li>- When Drift/Quick is cleared, <b>[HIGH]</b> Fan speed is selected</li> <li>- During <b>[AUTO]</b> operation, when <b>[LOW]/[HIGH]/[SUPER]</b> is selected, Drift/Quick function in operation is cleared</li> </ul> </li> </ul>
Filter replacement alarm	<ul style="list-style-type: none"> <li>• <b>[Clear]</b> button: in case of filter replacement alarm, it cancels filter replacement alarm</li> </ul>
Additional function	<ul style="list-style-type: none"> <li>• Quick <b>[Set/Clear]</b> button: Set/clear Quick function (When Quick function is selected, Drift function is cleared)</li> <li>• Drift <b>[Set/Clear]</b> button: Set/clear Drift function (When Drift function is selected, Quick function is cleared)</li> <li>• Heater <b>[Set/Clear]</b> button: Set/clear heater function</li> </ul>
Midnight air cooling(NTFC)	<ul style="list-style-type: none"> <li>• <b>[Set/Clear]</b> button: Set/Clear Midnight air cooling(NTFC) function that can outdoor unit cooling when outdoor temperature is lower than the base temperature at night time</li> </ul>
HardLock	<ul style="list-style-type: none"> <li>• <b>[Set/Clear]</b> button: Set/clear HardLock so that user cannot control any function with individual remote controller</li> </ul>

**DXHRV**

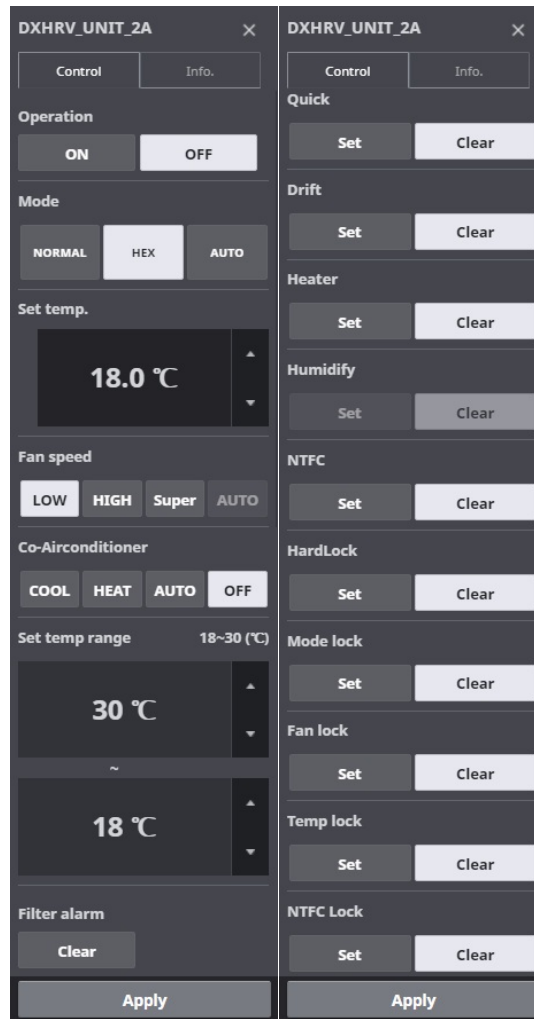

Category	Contents
Operation	<ul style="list-style-type: none"> <li>• <b>[ON]</b> button: starts the device operation</li> <li>• <b>[OFF]</b> button: Stops the device operation</li> </ul>
Mode	<ul style="list-style-type: none"> <li>• <b>[NORMAL]</b> button: Discharged air ventilates without going through the electric heat exchanger</li> <li>• <b>[HEX]</b> button: Both air supply/discharge ventilates through the electric heat exchanger</li> <li>• <b>[AUTO]</b> button: Switches to four seasons mode</li> </ul>
Set temperature	Press <b>[▲]</b> / <b>[▼]</b> button to set the desired temperature
Fan speed	Wind strength setting <ul style="list-style-type: none"> <li>• <b>[LOW]</b> button: Set the fan speed to slow</li> <li>• <b>[HIGH]</b> button: Set the fan speed to fast</li> <li>• <b>[SUPER]</b> button: Set the fan speed to Max. speed</li> <li>• <b>[AUTO]</b> button: <b>[LOW]-[HIGH]-[SUPER]</b> automatic switching                             <ul style="list-style-type: none"> <li>- User setting is impossible</li> <li>- When Drift/Quick is set, <b>[AUTO]</b> Fan speed is selected</li> <li>- When Drift/Quick is cleared, <b>[HIGH]</b> Fan speed is selected</li> <li>- During <b>[AUTO]</b> operation, when <b>[LOW]/[HIGH]/[SUPER]</b> is selected, Drift/Quick function in operation is cleared</li> </ul> </li> </ul>
Air conditioner	<ul style="list-style-type: none"> <li>• <b>[COOL]</b> button: Operates the direct cooling type ventilation in cooling mode</li> <li>• <b>[AUTO]</b> button: Automatically operates the direct cooling type ventilation by deciding the indoor condition</li> <li>• <b>[HEAT]</b> button: Operates the direct cooling type ventilation as heating mode</li> <li>• <b>[OFF]</b> button: Stops the air conditioner of the direct cooling type ventilation</li> </ul>
Set temp range	When user set the desired temperature individually, the desired temperature outside the designated temperature boundary cannot be set
Filter replacement alarm	<ul style="list-style-type: none"> <li>• <b>[Clear]</b> button: in case of filter replacement alarm, it cancels filter replacement alarm</li> </ul>

Additional function	<ul style="list-style-type: none"> <li>• Quick <b>[Set/Clear]</b> button: Set/clear Quick function (When Quick function is selected, Drift function is cleared)</li> <li>• Drift <b>[Set/Clear]</b> button: Set/clear Drift function (When Drift function is selected, Quick function is cleared)</li> <li>• Heater <b>[Set/Clear]</b> button: Set/clear heater function</li> <li>• Humidify <b>[Set]</b> button: Set Humidify function (only for air conditioner heating mode)</li> </ul>
Midnight air cooling(NTFC)	<ul style="list-style-type: none"> <li>• <b>[Set/Clear]</b> button: Set/Clear Midnight air cooling(NTFC) function that can outdoor unit cooling when outdoor temperature is lower than the base temperature at night time</li> </ul>
HardLock	<ul style="list-style-type: none"> <li>• <b>[Set/Clear]</b> button: Set/clear HardLock so that user cannot control any function with individual remote controller</li> </ul>
Mode lock	<ul style="list-style-type: none"> <li>• <b>[Set/Clear]</b> button: Set/clear lock so that user cannot control mode setting with individual remote controller</li> </ul>
Fan lock	<ul style="list-style-type: none"> <li>• <b>[Set/Clear]</b> button: Set/clear lock so that user cannot control Fan speed setting with individual remote controller</li> </ul>
TempLock	<ul style="list-style-type: none"> <li>• <b>[Set/Clear]</b> button: Set/clear lock so that user cannot control temperature setting with individual remote controller</li> </ul>
Midnight air cooling(NTFC) lock	<ul style="list-style-type: none"> <li>• <b>[Set/Clear]</b> button: Set/Clear Midnight air cooling(NTFC) schedule set in the remote controller</li> </ul>

**AWHP**

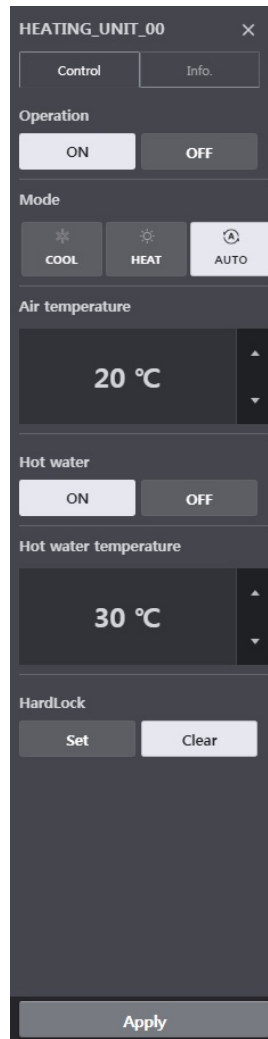

Category	Contents
Operation	<ul style="list-style-type: none"> <li>• <b>[ON]</b> button: starts the device operation</li> <li>• <b>[OFF]</b> button: Stops the device operation</li> </ul>
Mode	<ul style="list-style-type: none"> <li>• <b>[COOL]</b> button: Swtiches to cooling mode</li> <li>• <b>[HEAT]</b> button: Switches to heating mode</li> <li>• <b>[AUTO]</b> button: Switches to automatic mode</li> </ul>
Air/Water in/out temperature	<p>Press <b>[▲]/[▼]</b> button to set Air/Water in/out temperature</p> <p>It is displayed based on the set temperature selected in <b>[Setting]-[Installing]</b></p> <ul style="list-style-type: none"> <li>• When <b>[Water in/out]</b> is selected, it is displayed as water in/out temperature</li> <li>• When <b>[indoor]</b> is selected, it is displayed as air temperature</li> </ul>
Hot water	<ul style="list-style-type: none"> <li>• <b>[ON]</b> button: Starts hot water operation <ul style="list-style-type: none"> <li>- If hot water is operated while the device is in automatic/cooling operation, the corresponding mode and hot water are displayed in the icon of the contents display section</li> <li>- If hot water is operated while the device is stopped, the icon in the contents display section is enabled, and hot water is displayed</li> </ul> </li> <li>• <b>[OFF]</b> button: Stops hot water operation</li> </ul>
Hot water temperature	<p>Press <b>[▲]/[▼]</b> button to set hot water temperature</p>
HardLock	<ul style="list-style-type: none"> <li>• <b>[Set/Clear]</b> button: Set/clear HardLock so that user cannot control any function with individual remote controller</li> </ul>



AHU

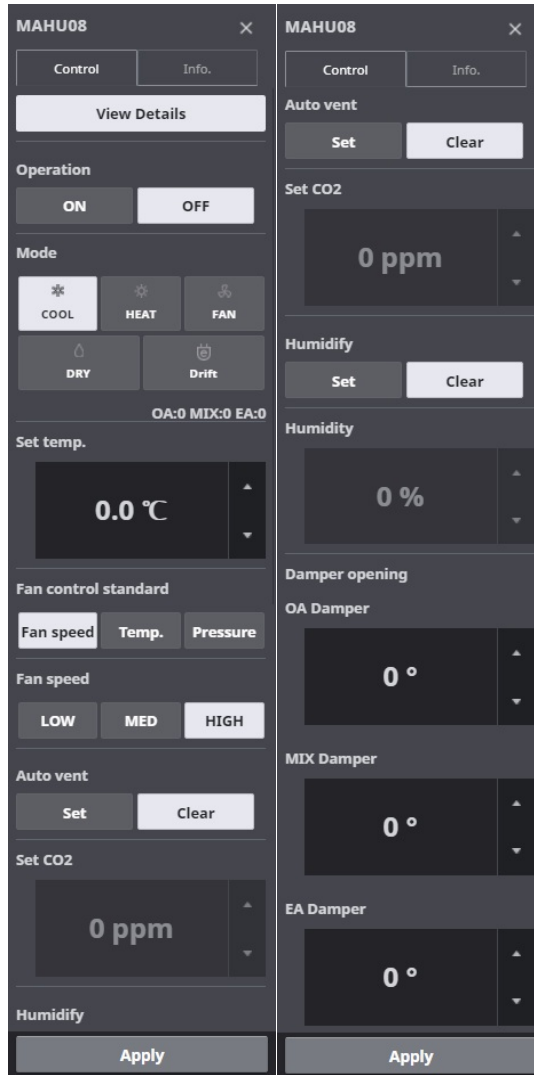

Category	Contents
View Details	Press <b>[View Details]</b> button to check detail information (But, mobile is excluded)
Operation	<ul style="list-style-type: none"> <li>• <b>[ON]</b> button: starts the device operation</li> <li>• <b>[OFF]</b> button: Stops the device operation</li> </ul>
Mode	<ul style="list-style-type: none"> <li>• <b>[COOL]</b> button: Switches to cooling mode</li> <li>• <b>[HEAT]</b> button: Switches to heating mode</li> <li>• <b>[FAN]</b> button: Air purification operation. When FAN is selected, you cannot set the desired temperature</li> <li>• <b>[DRY]</b> button: Removes moisture in rainy season or when humidity is high. When DRY is selected, you cannot set the desired temperature</li> <li>• <b>[Drift]</b> button: Operation to find the operation point with the best ventilation system efficiency to save power consumption. It fluently discharges the contaminated indoor air by having bigger discharger Fan speed than air supply</li> </ul>
Set temperature	Press <b>[▲]/[▼]</b> button to set the temperature
Fan control standard	<ul style="list-style-type: none"> <li>• <b>[Fan speed]</b> button: Controls the fan based on Fan speed status</li> <li>• <b>[Temp]</b> button: Controls the fan based on temperature status</li> <li>• <b>[Pressure]</b> button: Controls the fan based on Pressure status</li> </ul>
Fan speed	It is displayed only when fan control standard is Fan speed <ul style="list-style-type: none"> <li>• <b>[LOW]</b> button: Set the fan speed to slow</li> <li>• <b>[MED]</b> button: Set the fan speed to normal</li> <li>• <b>[HIGH]</b> button: Set the fan speed to fast</li> </ul>
Automatic ventilation	It is displayed only when the additional function's automatic ventilation or automatic ventilation and Humidify are selected during AHU device registration <ul style="list-style-type: none"> <li>• Automatic ventilation <b>[Set/Clear]</b> button: Starts/stops automatic ventilation</li> </ul>

Set CO <sub>2</sub>	It is enabled only when automatic ventilation function is set Press <b>[▲]/[▼]</b> button to set in the unit of 100ppm within 100 ppm ~ 2 000 ppm range
Humidify	It is displayed only when the additional function's Humidify or automatic ventilation and Humidify are selected during AHU device registration <ul style="list-style-type: none"> <li>Humidify <b>[Set/Clear]</b> button: Starts/stops Humidify function</li> </ul>
Humidity	It is enabled only when Humidify function is set Press <b>[▲]/[▼]</b> button to set the target humidity
Damper opening	<ul style="list-style-type: none"> <li>Press <b>[OA Damper]</b> : <b>[▲]/[▼]</b> button to set the outdoor unit air damper opening value in the unit of 1 ° within 0 ° ~ 90 ° range</li> <li>Press <b>[MIX Damper]</b> : <b>[▲]/[▼]</b> button to set the mixer damper opening value in the unit of 1 ° within 0 ° ~ 90 ° range</li> <li>Press <b>[EA Damper]</b> : <b>[▲]/[▼]</b> button to set the air discharge damper opening value in the unit of 1 ° within 0 ° ~ 90 ° range</li> </ul> <p>When you set <b>[Setting]-[system setting]'s Apply damper opening formula</b> as <b>set</b>, it operates as OA Damper = EA Damper, OA Damper = MIX Damper = 90</p>
HardLock	<ul style="list-style-type: none"> <li><b>[Set/Clear]</b> button: Set/clear HardLock so that user cannot control any function with individual remote controller</li> </ul>

## View AHU in detail

In AHU's control screen, you can press **[View Details]** button to check detail information.

The screenshot displays the AHU control interface for 'Campus #1'. At the top, there is a status bar with 'Operation status' showing 3 ON and 21 OFF, and indicators for 'Device error 0' and 'Network error 21'. A 'Help' button is also present.

The main area features a 3D schematic of the AHU unit with various components labeled:

- EA (Exhaust Air)**: Top left section with a damper set to 0°.
- RA (Return Air)**: Top right section with a damper set to 0°.
- OA (Outdoor Air)**: Bottom left section with a damper set to 0°.
- SA (Supply Air)**: Bottom right section with a damper set to 0°.

Key parameters shown in the schematic include:

- Temperature 30.0°C, Humidity 0%, CO<sub>2</sub> 0ppm (top right)
- Temperature 30.0°C, Humidity 0% (middle left)
- SA static pressure 0Pa, Temperature 30.0°C, Humidity 0% (bottom right)
- Temperature 30.0°C (bottom center)

On the right side, a control panel for 'MAHU\_Fresh' is visible, featuring:

- Buttons for 'Control' and 'Info'.
- A 'View Details' button.
- 'Operation' status with 'ON' and 'OFF' buttons.
- 'Mode' selection: COOL, HEAT, FAN, DRY, and Drift.
- 'Set temp.' display showing 18.0°C with up/down arrows.
- 'Fan control standard' buttons: Fan speed, Temp., and Pressure.
- 'Fan speed' control with a slider.
- An 'Apply' button at the bottom.

Scroll chiller

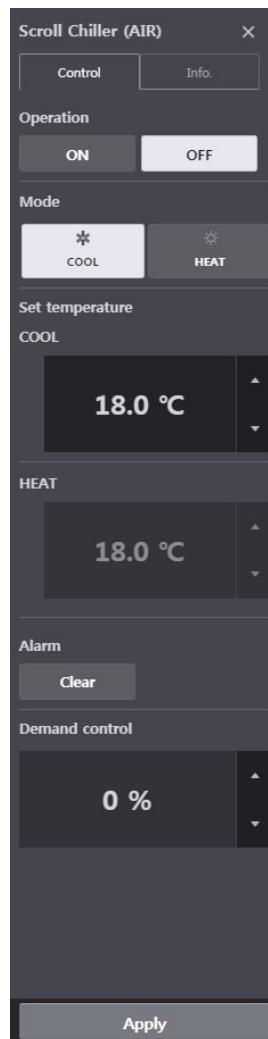

Category	Contents
Operation	<ul style="list-style-type: none"> <li>• <b>[ON]</b> button: starts the device operation</li> <li>• <b>[OFF]</b> button: Stops the device operation</li> </ul>
Mode	(It is displayed only when device supports the corresponding mode) <ul style="list-style-type: none"> <li>• <b>[COOL]</b> button: Switches to cooling mode</li> <li>• <b>[HEAT]</b> button: Switches to heating mode</li> </ul>
Set temperature	Set the load water out temperature for indoor cooling/heating Press <b>[▲]/[▼]</b> button to set the temperature of cooling mode and heating mode
Alarm	<b>[Clear]</b> button: Clears Chiller alarm in case of Chiller alarm
Demand control	Press <b>[▲]/[▼]</b> button to set demand limit ratio

Screw chiller

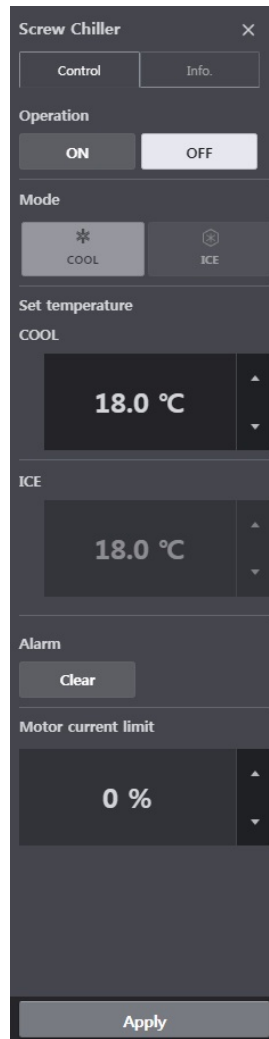

Category	Contents
Operation	<ul style="list-style-type: none"> <li>• <b>[ON]</b> button: starts the device operation</li> <li>• <b>[OFF]</b> button: Stops the device operation</li> </ul>
Mode	Mode control is impossible. Controls monitored operation mode's set temperature
Set temperature	Set the load water out temperature for indoor cooling/ice making Press <b>[▲]/[▼]</b> button to set the temperature of cooling mode and ice making mode
Alarm	<b>[Clear]</b> button: Clears Chiller alarm in case of Chiller alarm
Motor current limit	Press <b>[▲]/[▼]</b> button to set motor current limit ratio

**Turbo chiller**

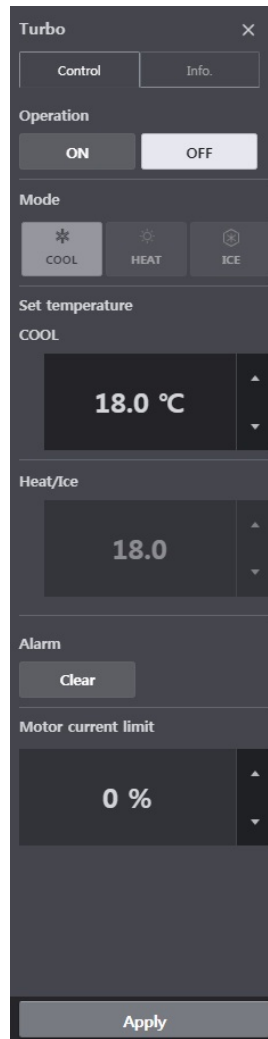

Category	Contents
Operation	<ul style="list-style-type: none"> <li>• <b>[ON]</b> button: starts the device operation</li> <li>• <b>[OFF]</b> button: Stops the device operation</li> </ul>
Mode	Mode control is impossible. Controls monitored operation mode's set temperature
Set temperature	Set the load water out temperature for indoor cooling/heating/ice making Press <b>[▲]/[▼]</b> button to set the temperature of cooling mode and heating/ice making mode
Alarm	<b>[Clear]</b> button: Clears Chiller alarm in case of Chiller alarm
Motor current limit	Press <b>[▲]/[▼]</b> button to set motor current limit ratio

## Absorption Chiller

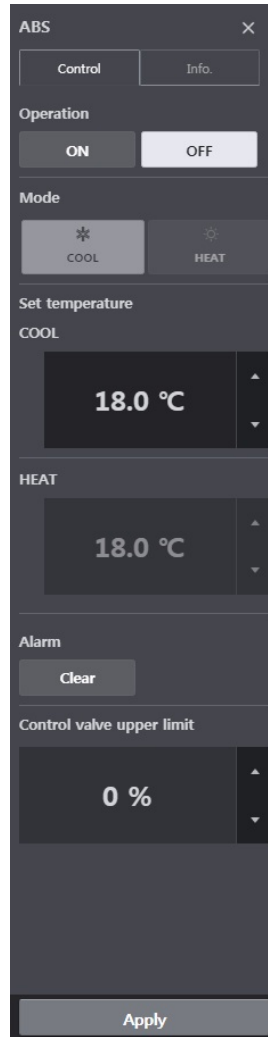

Category	Contents
Operation	<ul style="list-style-type: none"> <li>• <b>[ON]</b> button: starts the device operation</li> <li>• <b>[OFF]</b> button: Stops the device operation</li> </ul>
Mode	Mode control is impossible. Controls monitored operation mode's set temperature
Set temperature	Set the load water out temperature for indoor cooling/heating Press <b>[▲]/[▼]</b> button to set the temperature of cooling mode and heating mode
Alarm	<b>[Clear]</b> button: Clears Chiller alarm in case of Chiller alarm
Control valve upper limit	Press <b>[▲]/[▼]</b> button to set the control valve upper limit ratio

**DOKIT**

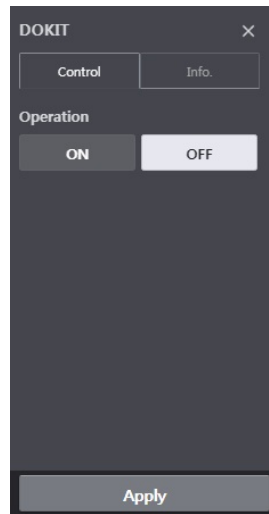

Category	Contents
Operation	<ul style="list-style-type: none"><li>• <b>[ON]</b> button: starts the device operation</li><li>• <b>[OFF]</b> button: Stops the device operation</li></ul>



DO

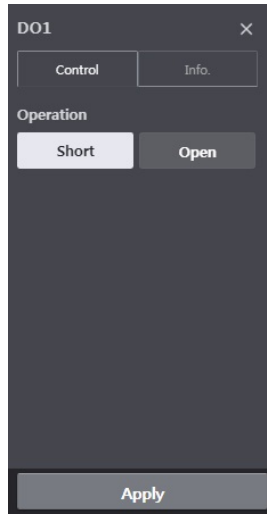

Category	Contents
Operation	<ul style="list-style-type: none"><li>• <b>[Short]</b> button: Short signal output</li><li>• <b>[Open]</b> button: Open signal output</li></ul>



## AO

AO[F7/00]×

ControlInfo.

Temperature (°C)

20.00

Min 0 ~ Max 100

Apply

Category	Contents
Temperature	Set temperature value

### Note

Unit symbol may change according to the usage set during device registration.



## Device Information

When you click device information tab in the device's control screen, you can check the device information.

You can check device's basic information, operation information, schedule information, error information, and today's history.

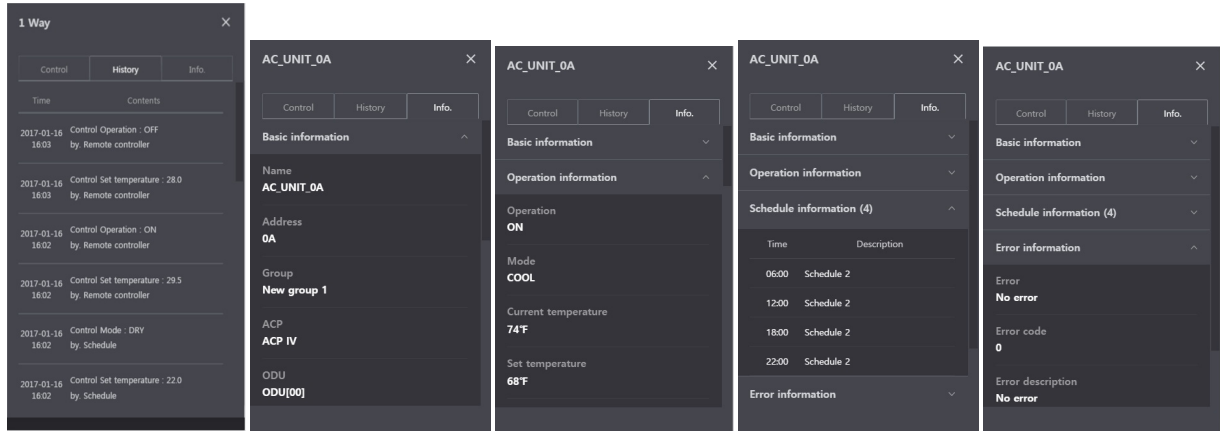



## Schedule Control

Schedule is a function for device to perform reserved operation at certain time by designating device operation in advance. When this function is used, device operation can be managed in time unit efficiently and energy saving effect is excellent.

### [Schedule]

- Check schedule

## Check schedule

You can see all set schedules.

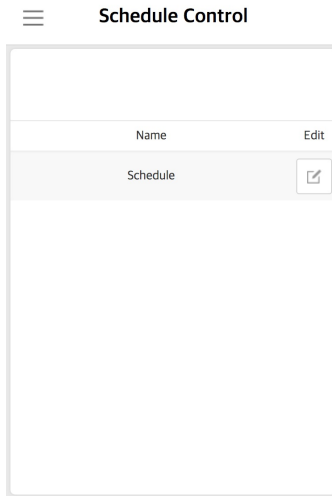

When you click Edit icon, you can check detail contents of the chedule.

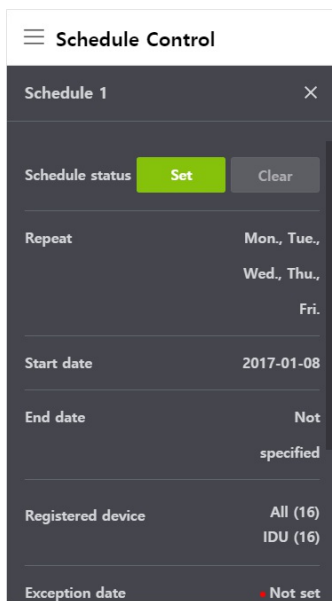



## BACnet/Modbus Protocol

AC Smart 5 can be linked with the BMS (Building Management System) that supports the BACnet IP/Modbus TCP protocol. The functions that can be controlled or monitored by the BMS vary depending on the protocol.

### [BACnet]

- Commission
- Object List
- BIBBs
- PICS

### [Modbus]

- Commission
- Function code
- Register List



### BACnet Commission

Commissioning is the process of verifying the subsystems to achieve the owner's project requirements as intended by the building owner and as designed by the building architects and engineers.

After AC Smart 5 installation, you can check the operation status of the device by using the web function before connection with the BMS system.

Creating of the Points. This is NOT to be done by LG since it is directly related to the BMS side. The BMS engineer is to carry out the engineering of the Point, however LG is responsible for providing the method of how the Points are calculated.

### Precautions

- To use BACnet feature, you must select **[Settings] > [BACnet/Modbus Setting] > [BACnet enable]** as **Set**.
- In case of installing 2 or more AC Smart 5, you must change **[Settings] > [BACnet/Modbus Setting] > [Device ID Setting]** so that the Device IDs are not duplicate among AC Smart 5. It is recommended that you keep a difference of 10 or more for different Device IDs.
- If Device Discover doesn't work well, change **[Settings] > [BACnet/Modbus Setting] > [BACnet Type Setting]**.
- It is recommended that you request ReadProperty/WriteProperty at an interval of 200 ms or more for each property.
- It is recommended that you request ReadPropertyMultiple/WritePropertyMultiple at an interval of 500 ms or more for each property.
- SubscribeCOV can be registered up to 1024.
- If AC Smart 5 and BMS are located on different networks, BBMD (BACnet/IP Broadcast Management Device) is needed.
- As AC Smart 5 does not support the BBMD function, a separate BBMD is required. You can register AC Smart 5 as a foreign device in BBMD using **[Settings] > [BACnet/Modbus Setting] > [Register as Foreign Device]** function.



## BACnet Object List

It describes the BACnet object list provided by AC Smart 5.

- Instance Number
- Indoor Unit Object List
- Ventilation Object List
- AHU Object List
- Outdoor Unit Object List
- AWHP Object List
- General Object List

## Definition of Instance Number

The instance number of each device is assigned as follows

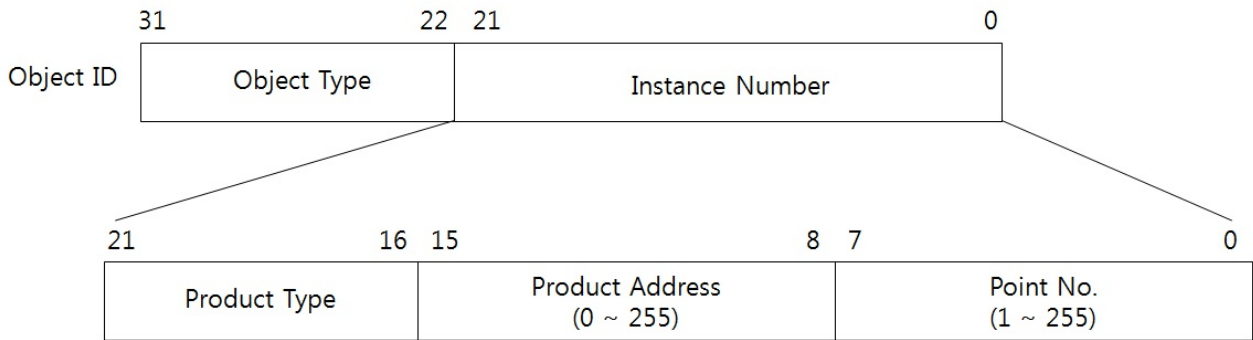

Product Type (Indoor: 0, Vent: 1, AHU : 2, ODU : 3, AWHP : 4, General : 5)

## Example of Instance Number

Description	Product Type	Product Address	Point	Instance Number
IDU Address 0x00, On/Off (Setting)	0	0	1	1
IDU Address 0x00, Operation Mode (Setting)	0	0	7	7
IDU Address 0x1B, On/Off (Setting)	0	27	1	6913
IDU Address 0x1B, Operation Mode (Setting)	0	27	7	6919
Vent Address 0x00, On/Off (Setting)	1	0	1	65537
Vent Address 0x00, Operation Mode (Setting)	1	0	7	65543
Vent Address 0x1B, On/Off (Setting)	1	27	1	72449
Vent Address 0x1B, Operation Mode (Setting)	1	27	7	72455
AHU Address 0x00, On/Off (Setting)	2	0	1	131073
AHU Address 0x00, Operation Mode (Setting)	2	0	7	131079
AHU Address 0x0F, On/Off (Setting)	2	15	1	134913
AHU Address 0x0F, Operation Mode (Setting)	2	15	7	134919
ODU Address 0x00, Compressor Operation Status	3	0	1	196609
ODU Address 0x00, Operation Mode	3	0	14	196622
ODU Address 0x0F, Compressor Operation Status	3	15	1	200449
ODU Address 0x0F, Operation Mode	3	15	14	200462
AWHP Address 0x00, On/Off (Setting)	4	0	1	262145
AWHP Address 0x00, Operation Mode (Setting)	4	0	5	262149
AWHP Address 0x0F, On/Off (Setting)	4	15	1	265985
AWHP Address 0x0F, Operation Mode (Setting)	4	15	5	265989
General Object, All Unit Run/Stop (Setting)	5	0	1	327681
General Object, All Unit Set Room Temperature (Setting)	5	0	2	327682

## Indoor Unit Object List

One Indoor unit has the following list of points. Some points may not be supported depending on the product.

Point	Description	Object Name(_XXX : Address)	Object Type	Unit	Text-0	Text-1	Text-2	Text-3	Text-4	Text-5	Text-6
1	On/Off (Setting)	StartStopCommand_XXX	BO	-	Stop (0)	Start (1)	-	-	-	-	-
2	On/Off (Status)	StartStopStatus_XXX	BI	-	Stop (0)	Start (1)	-	-	-	-	-
3	Lock (Setting)	LockCommand_XXX	BO	-	Permit (0)	Prohibit (1)	-	-	-	-	-
4	Lock (Status)	LockStatus_XXX	BI	-	Permit (0)	Prohibit (1)	-	-	-	-	-
5	Filter Sign	FilterSign_XXX	BI	-	Off (0)	On (1)	-	-	-	-	-
6	Filter Sign reset	FilterSignReset_XXX	BV	-	-	Reset (1)	-	-	-	-	-
7	Operation Mode (Setting)	AirConModeCommand_XXX	MO	-	-	Cool (1)	Dry (2)	Fan (3)	Auto (4)	Heat (5)	-
8	Operation Mode (Status)	AirConModeStatus_XXX	MI	-	-	Cool (1)	Dry (2)	Fan (3)	Auto (4)	Heat (5)	-
9	Swing (Setting)	SwingCommand_XXX	BO	-	Stop (0)	Start (1)	-	-	-	-	-
10	Swing (Status)	SwingStatus_XXX	BI	-	Stop (0)	Start (1)	-	-	-	-	-
11	Fan Speed (Setting)	FanSpeedCommand_XXX	MO	-	-	Low (1)	Middle (2)	High (3)	Auto (4)	-	-
12	Fan Speed (Status)	FanSpeedStatus_XXX	MI	-	-	Low (1)	Middle (2)	High (3)	Auto (4)	-	-
13	Set Room Temperature	SetRoomTemp_XXX	AV	°C(°F)	16 °C ~ 30 °C (60 °F ~ 86 °F)						
14	Set Temperature (Status)	RoomTemp_XXX	AI	°C(°F)							
15	Alarm	Alarm_XXX	BI	-	Normal (0)	Abnormal (1)	-	-	-	-	-
16	Error Code	MalfunctionCode_XXX	AI	-	Please refer to LG error code list.						
17	-	-	-	-	-						
18	-	-	-	-	-						
19	Room Temperature	SetTempStatus_XXX	AI	°C(°F)	16 °C ~ 30 °C (60 °F ~ 86 °F)						
20	Accumulated Power Distribution (Status)	Accumulated power(100 Watt)_XXX	AI	100 Watt	Wattage values						
21	-	-	-	-	-						
22	-	-	-	-	-						
23	-	-	-	-	-						
24	-	-	-	-	-						
25	-	-	-	-	-						
26	-	-	-	-	-						
27	Set Upper Temperature (Setting)	TempRangeUpperLimitCommand_XXX	AV	°C(°F)	18 °C ~ 30 °C (64 °F ~ 86 °F)						
28	Set Upper Temperature (Status)	TempRangeLowerLimitCommand_XXX	AV	°C(°F)	16 °C ~ 30 °C (60 °F ~ 86 °F)						

29	Set Lower Temperature (Setting)	TempRangeUpperLimitStatus_XXX	AI	°C(°F)	18 °C ~ 30 °C (64 °F ~ 86 °F)						
30	Set Lower Temperature (Status)	TempRangeLowerLimitStatus_XXX	AI	°C(°F)	16 °C ~ 30 °C (60 °F ~ 86 °F)						
31	Mode Lock (Setting)	ModeLockCommand_XXX	BO	-	Permit (0)	Prohibit (1)	-	-	-	-	-
32	Mode Lock (Status)	ModeLockStatus_XXX	BI	-	Permit (0)	Prohibit (1)	-	-	-	-	-
33	Fan Lock (Setting)	FanLockCommand_XXX	BO	-	Permit (0)	Prohibit (1)	-	-	-	-	-
34	Fan Lock (Status)	FanLockStatus_XXX	BI	-	Permit (0)	Prohibit (1)	-	-	-	-	-
35	Occupancy (Setting)	OccupancyCommand_XXX	BO	-	Unoccupied (0)	Occupied (1)	-	-	-	-	-
36	Occupancy (Status)	OccupancyStatus_XXX	BI	-	Unoccupied (0)	Occupied (1)	-	-	-	-	-
37	2Set Cooling Set Temperature (Setting)	2SetCoolingTempCommand_XXX	AV	°C(°F)	10 °C ~ 37.5 °C (50 °F ~ 99 °F)						
38	2Set Cooling Set Temperature (Status)	2SetCoolingTempStatus_XXX	AI	°C(°F)	10 °C ~ 37.5 °C (50 °F ~ 99 °F)						
39	2Set Heating Set Temperature (Setting)	2SetHeatingTempCommand_XXX	AV	°C(°F)	4 °C ~ 32 °C (40 °F ~ 90 °F)						
40	2Set Heating Set Temperature (Status)	2SetHeatingTempStatus_XXX	AI	°C(°F)	4 °C ~ 32 °C (40 °F ~ 90 °F)						
41	2Set Cooling Upper Temperature (Setting)	2SetCoolingUpperLimitCommand_XXX	AV	°C(°F)	10 °C ~ 37.5 °C (50 °F ~ 99 °F)						
42	2Set Cooling Upper Temperature (Status)	2SetCoolingUpperLimitStatus_XXX	AI	°C(°F)	10 °C ~ 37.5 °C (50 °F ~ 99 °F)						
43	2Set Cooling Lower Temperature (Setting)	2SetHeatingUpperLimitCommand_XXX	AV	°C(°F)	4 °C ~ 32 °C (40 °F ~ 90 °F)						
44	2Set Cooling Lower Temperature (Status)	2SetHeatingUpperLimitStatus_XXX	AI	°C(°F)	4 °C ~ 32 °C (40 °F ~ 90 °F)						
45	2Set Heating Upper Temperature (Setting)	2SetCoolingLowerLimitCommand_XXX	AV	°C(°F)	10 °C ~ 37.5 °C (50 °F ~ 99 °F)						
46	2Set Heating Upper Temperature (Status)	2SetCoolingLowerLimitStatus_XXX	AI	°C(°F)	10 °C ~ 37.5 °C (50 °F ~ 99 °F)						
47	2Set Heating Lower Temperature (Setting)	2SetHeatingLowerLimitCommand_XXX	AV	°C(°F)	4 °C ~ 32 °C (40 °F ~ 90 °F)						
48	2Set Heating Lower Temperature	2SetHeatingLowerLimitStatus_XXX	AI	°C(°F)	4 °C ~ 32 °C (40 °F ~ 90 °F)						

	(Status)										
49	Thermo Status (Status)	ThermoStatus_XXX	BI	-	Stop (0)	Start (1)	-	-	-	-	-
50	Accumulated Gas Distribution (Status)	AccumulatedGas(100 Watt)_XXX	AI	100 Liter	Gas values						
51	Dust Sensor Available (Status)	DustSensorAvail_XXX	BI	-	Disabled (0)	Enabled (1)	-	-	-	-	-
52	Air Cleaning Operation (Setting)	AirCleaningOperCommand_XXX	BO	-	Stop (0)	Start (1)	-	-	-	-	-
53	Air Cleaning Operation (Status)	AirCleaningOperStatus_XXX	BI	-	Stop (0)	Start (1)	-	-	-	-	-
54	Fine Dust (Status)	FineDustStatus_XXX	AI	µg/m <sup>3</sup>							
55	Ultra Fine Dust (Status)	UltraFineDustStatus_XXX	AI	µg/m <sup>3</sup>							
56	Super Ultra Fine Dust (Status)	SuperUltraFineDustStatus_XXX	AI	µg/m <sup>3</sup>							
57	Humidity (Status)	HumidityStatus_XXX	AI	%							
58	Comfort Cooling Available (Status)	ComfortCoolingAvail_XXX	BI	-	Disabled (0)	Enabled (1)	-	-	-	-	-
59	Comfort Cooling Operation (Setting)	ComfortCoolingOperCommand_XXX	BO	-	Stop (0)	Start (1)	-	-	-	-	-
60	Comfort Cooling Operation (Status)	ComfortCoolingOperStatus_XXX	BI	-	Stop (0)	Start (1)	-	-	-	-	-
61	Comfort Cooling Step (Setting)	ComfortCoolingStepCommand_XXX	AV	-	1 step ~ 3 step						
62	Comfort Cooling Step (Status)	ComfortCoolingStepStatus_XXX	AI	-	1 step ~ 3 step						
63	Human Detection Available (Status)	HumanDetectionAvail_XXX	BI	-	Disabled (0)	Enabled (1)	-	-	-	-	-
64	Human Detection Operation (Setting)	HumanDetectionOperCommand_XXX	MO	-	-	Stop (1)	OnOffSaving (2)	TempSaving (3)	-	-	-
65	Human Detection Operation (Status)	HumanDetectionOperStatus_XXX	MI	-	-	Stop (1)	OnOffSaving (2)	TempSaving (3)	-	-	-
66	Human Detection Wind (Setting)	HumanDetectionWindCommand_XXX	MO	-	-	Stop (1)	Direct (2)	Indirect (3)	-	-	-
67	Human Detection Wind (Status)	HumanDetectionWindStatus_XXX	MI	-	-	Stop (1)	Direct (2)	Indirect (3)	-	-	-
68	Human Detection Time (Setting)	HumanDetectionTimeCommand_XXX	MO	-	-	5 min (1)	10 min (2)	15 min (3)	30 min (4)	60 min (5)	90 min (6)
69	Human Detection Time (Status)	HumanDetectionTimeStatus_XXX	MI	-	-	5 min (1)	10 min (2)	15 min (3)	30 min (4)	60 min (5)	90 min (6)



## Ventilation Object List

One ventilation has the following list of points. Some points may not be supported depending on the product.

Point	Description	Object Name(_XXX : Address)	Object Type	Unit	Text-0	Text-1	Text-2	Text-3	Text-4	Text-5	Text-6
1	On/Off (Setting)	StartStopCommand_XXX	BO	-	Stop (0)	Start (1)	-	-	-	-	-
2	On/Off (Status)	StartStopStatus_XXX	BI	-	Stop (0)	Start (1)	-	-	-	-	-
3	Lock (Setting)	LockCommand_XXX	BO	-	Permit (0)	Prohibit (1)	-	-	-	-	-
4	Lock (Status)	LockStatus_XXX	BI	-	Permit (0)	Prohibit (1)	-	-	-	-	-
5	Filter Sign	FilterSign_XXX	BI	-	Off (0)	On (1)	-	-	-	-	-
6	Filter Sign reset	FilterSignReset_XXX	BV	-	-	Reset (1)	-	-	-	-	-
7	Operation Mode (Setting)	AirConModeCommand_XXX	MO	-	-	Heat Exchange (1)	Auto (2)	Normal (3)	-	-	-
8	Operation Mode (Status)	AirConModeStatus_XXX	MI	-	-	Heat Exchange (1)	Auto (2)	Normal (3)	-	-	-
9	-	-	-	-	-						
10	-	-	-	-	-						
11	Fan Speed (Setting)	FanSpeedCommand_XXX	MO	-	-	Low (1)	High (2)	Super High (3)	Auto (4)	-	-
12	Fan Speed (Status)	FanSpeedStatus_XXX	MI	-	-	Low (1)	High (2)	Super High (3)	Auto (4)	-	-
13	Set Room Temperature	SetRoomTemp_XXX	AV	°C(°F)	16 °C ~ 30 °C (60 °F ~ 86 °F)						
14	Set Temperature (Status)	RoomTemp_XXX	AI	°C(°F)							
15	Alarm	Alarm_XXX	BI	-	Normal (0)	Abnormal (1)	-	-	-	-	-
16	Error Code	MalfunctionCode_XXX	AI	-	Please refer to LG error code list.						
17	User Mode (Setting)	UserModeCommand_XXX	MO	-	-	Quick fresh (1)	Energy saving (2)	Clear (3)	-	-	-
18	User Mode (Status)	UserModeStatus_XXX	MI	-	-	Quick fresh (1)	Energy saving (2)	Clear (3)	-	-	-
19	Room Temperature	SetTempStatus_XXX	AI	°C(°F)	16 °C ~ 30 °C (60 °F ~ 86 °F)						
20	Accumulated Power Distribution (Status)	Accumulated power(100 Watt)_XXX	AI	100 Watt	Wattage values						
21	AC Operation Mode (Setting)	UserModeAcCommand_XXX	MO	-	-	Cool (1)	Auto (2)	Heat (3)	-	-	-
22	AC Operation Mode (Status)	UserModeStatus_XXX	MI	-	-	Cool (1)	Auto (2)	Heat (3)	-	-	-
23	AC ON/OFF (Setting)	UserModeAcCommand_XXX	BO	-	Stop (0)	Start (1)	-	-	-	-	-
24	AC ON/OFF (Status)	UserModeAcStatus_XXX	BI	-	Stop (0)	Start (1)	-	-	-	-	-
25	AC Humidify (Setting)	HumidifierOperCommand_XXX	BO	-	Stop (0)	Start (1)	-	-	-	-	-
26	AC Humidify (Status)	HumidifierOperStatus_XXX	BI	-	Stop (0)	Start (1)	-	-	-	-	-
27	Partial Lock Available (Status)	PatialLockAvail_XXX	BI	-	Disabled (0)	Enabled (1)	-	-	-	-	-
28	Set Upper Temperature (Setting)	TempRangeUpperLimitCommand_XXX	AV	°C(°F)	18 °C ~ 30 °C (64 °F ~ 86 °F)						
	Set Upper Temperature										

29	(Status)	TempRangeLowerLimitCommand_XXX	AV	°C(°F)	16 °C ~ 30 °C (60 °F ~ 86 °F)						
30	Set Lower Temperature (Setting)	TempRangeUpperLimitStatus_XXX	AI	°C(°F)	18 °C ~ 30 °C (64 °F ~ 86 °F)						
31	Set Lower Temperature (Status)	TempRangeLowerLimitStatus_XXX	AI	°C(°F)	16 °C ~ 30 °C (60 °F ~ 86 °F)						
32	Mode Lock (Setting)	ModeLockCommand_XXX	BO	-	Permit (0)	Prohibit (1)	-	-	-	-	-
33	Mode Lock (Status)	ModeLockStatus_XXX	BI	-	Permit (0)	Prohibit (1)	-	-	-	-	-
34	Fan Lock (Setting)	FanLockCommand_XXX	BO	-	Permit (0)	Prohibit (1)	-	-	-	-	-
35	Fan Lock (Status)	FanLockStatus_XXX	BI	-	Permit (0)	Prohibit (1)	-	-	-	-	-
36	NTFC Available (Status)	NtfcAvail_XXX	BI	-	Disabled (0)	Enabled (1)	-	-	-	-	-
37	NTFC Operation (Setting)	NtfcOperCommand_XXX	BO	-	Stop (0)	Start (1)	-	-	-	-	-
38	NTFC Operation (Status)	NtfcOperStatus_XXX	BI	-	Stop (0)	Start (1)	-	-	-	-	-
39	NTFC Lock (Setting)	NtfcLockCommand_XXX	BO	-	Permit (0)	Prohibit (1)	-	-	-	-	-
40	NTFC Lock (Status)	NtfcLockStatus_XXX	BI	-	Permit (0)	Prohibit (1)	-	-	-	-	-

## AHU Object List

One AHU has the following list of points. Some points may not be supported depending on the product.

Point	Description	Object Name(_XXX : Address)	Object Type	Unit	Text-0	Text-1	Text-2	Text-3	Text-4	Text-5	Text-6
1	On/Off (Setting)	StartStopCommand_XXX	BO	-	Stop (0)	Start (1)	-	-	-	-	-
2	On/Off (Status)	StartStopStatus_XXX	BI	-	Stop (0)	Start (1)	-	-	-	-	-
3	Lock (Setting)	LockCommand_XXX	BO	-	Permit (0)	Prohibit (1)	-	-	-	-	-
4	Lock (Status)	LockStatus_XXX	BI	-	Permit (0)	Prohibit (1)	-	-	-	-	-
5	Filter Sign	FilterSign_XXX	BI	-	Off (0)	On (1)	-	-	-	-	-
6	-	-	-	-	-						
7	Operation Mode (Setting)	AirConModeCommand_XXX	MO	-	-	Cool (1)	Dry (2)	Fan (3)	Heat (4)	Energy saving (5)	-
8	Operation Mode (Status)	AirConModeStatus_XXX	MI	-	-	Cool (1)	Dry (2)	Fan (3)	Heat (4)	Energy saving (5)	-
9	-	-	-	-	-						
10	-	-	-	-	-						
11	Fan Speed (Setting)	FanSpeedCommand_XXX	MO	-	-	High (1)	Middle (2)	Low (3)	-	-	-
12	Fan Speed (Status)	FanSpeedStatus_XXX	MI	-	-	High (1)	Middle (2)	Low (3)	-	-	-
13	Set Room Temperature	SetRoomTemp_XXX	AV	°C (°F)	18 °C ~ 30 °C (64 °F ~ 86 °F)						
14	Set Temperature (Status)	RoomTemp_XXX	AI	°C (°F)	18 °C ~ 30 °C (64 °F ~ 86 °F)						
15	Alarm	Alarm_XXX	BI	-	Normal (0)	Abnormal (1)	-	-	-	-	-
16	Error Code	MalfunctionCode_XXX	AI	-	Please refer to LG error code list.						
17	-	-	-	-	-						
18	-	-	-	-	-						
19	Room Temperature	SetTempStatus_XXX	AI	°C (°F)	18 °C ~ 30 °C (64 °F ~ 86 °F)						
20	FireAlarm (Setting)	FireAlarmCommand_XXX	BO	-	Off (0)	On (1)	-	-	-	-	-
21	FireAlarm (Status)	FireAlarmStatus_XXX	BI	-	Off (0)	On (1)	-	-	-	-	-
22	Humidity (Setting)	SetHumidityCommand_XXX	AV	%	40 % ~ 60 %						
23	Humidity (Status)	SetHumidityStatus_XXX	AI	%	40 % ~ 60 %						
24	Humidify ON/OFF (Setting)	HumidifyCommand_XXX	BO	-	Stop (0)	Start (1)	-	-	-	-	-
25	Humidify ON/OFF (Status)	HumidifyStatus_XXX	BI	-	Stop (0)	Start (1)	-	-	-	-	-
26	Auto Ventilation ON/OFF (Setting)	AutoVentilCommand_XXX	BO	-	Stop (0)	Start (1)	-	-	-	-	-
27	Auto Ventilation ON/OFF (Status)	AutoVentilStatus_XXX	BI	-	Stop (0)	Start (1)	-	-	-	-	-
28	Supply Unit Temperature (Status)	SupplyTempStatus_XXX	AI	°C (°F)	18 °C ~ 30 °C (64 °F ~ 86 °F)						
29	Outdoor Unit Temperature (Status)	OutdoorTempStatus_XXX	AI	°C (°F)	18 °C ~ 30 °C (64 °F ~ 86 °F)						

30	Mix Unit Temperature (Status)	MixTempStatus_XXX	AI	°C (°F)										
31	Supply Unit Humidity (Status)	SupplyHumidifyStatus_XXX	AI	%										
32	Outdoor Unit Humidity (Status)	OutdoorHumidifyStatus_XXX	AI	%										
33	Ventilation Unit Humidity (Status)	VentilHumidifyStatus_XXX	AI	%										
34	CO2 Value (Status)	CO2ValueStatus_XXX	AI	-	0~255 (Real Value = Value*10, Example : In case Value is 20, CO2 is 20*10=200ppm)									
35	Humidity Unit ON/OFF (Status)	HumidifyUnitStatus_XXX	BI	-	Stop (0)	Start (1)	-	-	-	-	-	-	-	-
36	Heating Unit ON/OFF (Status)	HeaterUnitStatus_XXX	BI	-	Stop (0)	Start (1)	-	-	-	-	-	-	-	-
37	Ventilator FAN ON/OFF (Status)	VentilFanStatus_XXX	BI	-	Stop (0)	Start (1)	-	-	-	-	-	-	-	-
38	Supply Unit FAN ON/OFF (Status)	SupplyFanStatus_XXX	BI	-	Stop (0)	Start (1)	-	-	-	-	-	-	-	-
39	Current OA Damper (Status)	CurrOADamperStatus_XXX	AI	°	0° ~ 90°									
40	Current EA Damper (Status)	CurrEADamperStatus_XXX	AI	°	0° ~ 90°									
41	Current Mix Damper (Status)	CurrMixDamperStatus_XXX	AI	°	0° ~ 90°									
42	Cooling OA Damper (Setting)	OADamperCoolCommand_XXX	AV	°	0° ~ 90°									
43	Cooling OA Damper (Status))	OADamperCoolStatus_XXX	AI	°	0° ~ 90°									
44	Cooling EA Damper (Setting)	EADamperCoolCommand_XXX	AV	°	0° ~ 90°									
45	Cooling EA Damper (Status))	EADamperCoolStatus_XXX	AI	°	0° ~ 90°									
46	Cooling Mix Damper (Setting)	MixDamperCoolCommand_XXX	AV	°	0° ~ 90°									
47	Cooling Mix Damper (Status))	MixDamperCoolStatus_XXX	AI	°	0° ~ 90°									
48	Heating OA Damper (Setting)	OADamperHeatCommand_XXX	AV	°	0° ~ 90°									
49	Heating OA Damper (Status))	OADamperHeatStatus_XXX	AI	°	0° ~ 90°									
50	Heating EA Damper (Setting)	EADamperHeatCommand_XXX	AV	°	0° ~ 90°									
51	Heating EA Damper (Status))	EADamperHeatStatus_XXX	AI	°	0° ~ 90°									
52	Heating Mix Damper (Setting)	MixDamperHeatCommand_XXX	AV	°	0° ~ 90°									
53	Heating Mix Damper (Status))	MixDamperHeatStatus_XXX	AI	°	0° ~ 90°									
54	FAN OA Damper (Setting)	OADamperFanCommand_XXX	AV	°	0° ~ 90°									
55	FAN OA Damper (Status))	OADamperFanStatus_XXX	AI	°	0° ~ 90°									
56	FAN EA Damper (Setting)	EADamperFanCommand_XXX	AV	°	0° ~ 90°									
57	FAN EA Damper (Status))	EADamperFanStatus_XXX	AI	°	0° ~ 90°									
58	FAN Mix Damper (Setting)	MixDamperFanCommand_XXX	AV	°	0° ~ 90°									
59	FAN Mix Damper (Status))	MixDamperFanStatus_XXX	AI	°	0° ~ 90°									

## Outdoor unit Object List

One outdoor unit has the following list of points. Some points may not be supported depending on the product.

Point	Description	Object Name( _XXX : Address)	Object Type	Unit	Text-0	Text-1	Text-2	Text-3	Text-4	Text-5	Text-6
1	Compressor Operation Status	CompOperStatus_XXX	BI	-	Stop (0)	Start (1)	-	-	-	-	-
2	Refrigent Type	RefrigentType_XXX	MI	-	-	R407C (1)	R22 (2)	R410A (3)	-	-	-
3	Inverter Fan 1 frequency	InverterFanFreq_XXX	AI	rpm							
4	High Pressure	HighPressure_XXX	AI	kPa							
5	Low Pressure	LowPressure_XXX	AI	kPa							
6	Suction Temperature	SuctionTemp_XXX	AI	°C(°F)							
7	Liquid Pipe Temperature	LiquidPipeTemp_XXX	AI	°C(°F)							
8	Heat Exchanger Temperature	HexTemp_XXX	AI	°C(°F)							
9	Outdoor EEV	OutdoorEEV_XXX	AI	-							
10	Subcool EEV	SubCoolEEV_XXX	AI	-							
11	Hot Gas Valve	HotgasValue_XXX	BI	-	Stop (0)	Start (1)	-	-	-	-	-
12	Inverter Discharge Temperature	InverterDischargeTemp_XXX	AI	°C(°F)							
13	Outdoor Temperature	OutdoorTemp_XXX	AI	°C(°F)							
14	Operation Mode	OperationMode_XXX	MI	-	-	Stop (1)	Cool (2)	Heat (3)	-	-	-
15-32	Additional Point for Master Outdoor Unit										
33	(Slave1) Compressor Operation Status	CompOperStatus_XXX	BI	-	Stop (0)	Start (1)	-	-	-	-	-
34	(Slave1) Refrigerant Type	RefrigentType_XXX	MI	-	-	R407C (1)	R22 (2)	R410A (3)	-	-	-
35	(Slave1) Inverter Fan 1 frequency	InverterFanFreq_XXX	AI	rpm							
36	(Slave1) High Pressure	HighPressure_XXX	AI	kPa							
37	(Slave1) Low Pressure	LowPressure_XXX	AI	kPa							
38	(Slave1) Suction Temperature	SuctionTemp_XXX	AI	°C(°F)							
39	(Slave1) Liquid Pipe Temperature	LiquidPipeTemp_XXX	AI	°C(°F)							
40	(Slave1) Heat Exchanger Temperature	HexTemp_XXX	AI	°C(°F)							
41	(Slave1) Outdoor EEV	OutdoorEEV_XXX	AI	-							
42	(Slave1) Subcool EEV	SubCoolEEV_XXX	AI	-							
43	(Slave1) Hot Gas Valve	HotgasValue_XXX	BI	-	Stop (0)	Start (1)	-	-	-	-	-
44	(Slave1) Inverter Discharge Temperature	InverterDischargeTemp_XXX	AI	°C(°F)							
45	(Slave1) Outdoor Temperature	OutdoorTemp_XXX	AI	°C(°F)							
46	(Slave1) Operation Mode	OperationMode_XXX	MI	-	-	Stop (1)	Cool (2)	Heat (3)	-	-	-
47-64	Additional Point for Slave1 Outdoor Unit										
65	(Slave2) Compressor Operation Status	CompOperStatus_XXX	BI	-	Stop (0)	Start (1)	-	-	-	-	-
66	(Slave2) Refrigerant Type	RefrigentType_XXX	MI	-	-	R407C (1)	R22 (2)	R410A (3)	-	-	-
67	(Slave2) Inverter Fan 1 frequency	InverterFanFreq_XXX	AI	rpm							
68	(Slave2) High Pressure	HighPressure_XXX	AI	kPa							
69	(Slave2) Low Pressure	LowPressure_XXX	AI	kPa							
70	(Slave2) Suction Temperature	SuctionTemp_XXX	AI	°C(°F)							

71	(Slave2) Liquid Pipe Temperature	LiquidPipeTemp_XXX	AI	°C(°F)								
72	(Slave2) Heat Exchanger Temperature	HexTemp_XXX	AI	°C(°F)								
73	(Slave2) Outdoor EEV	OutdoorEEV_XXX	AI	-								
74	(Slave2) Subcool EEV	SubCoolEEV_XXX	AI	-								
75	(Slave2) Hot Gas Valve	HotgasValue_XXX	BI	-	Stop (0)	Start (1)	-	-	-	-	-	-
76	(Slave2) Inverter Discharge Temperature	InverterDischargeTemp_XXX	AI	°C(°F)								
77	(Slave2) Outdoor Temperature	OutdoorTemp_XXX	AI	°C(°F)								
78	(Slave2) Operation Mode	OperationMode_XXX	MI	-	-	Stop (1)	Cool (2)	Heat (3)	-	-	-	-
79-96	Additional Point for Slave2 Outdoor Unit											
97	(Slave3) Compressor Operation Status	CompOperStatus_XXX	BI	-	Stop (0)	Start (1)	-	-	-	-	-	-
98	(Slave3) Refrigerant Type	RefrigerantType_XXX	MI	-	-	R407C (1)	R22 (2)	R410A (3)	-	-	-	-
99	(Slave3) Inverter Fan 1 frequency	InverterFanFreq_XXX	AI	rpm								
100	(Slave3) High Pressure	HighPressure_XXX	AI	kPa								
101	(Slave3) Low Pressure	LowPressure_XXX	AI	kPa								
102	(Slave3) Suction Temperature	SuctionTemp_XXX	AI	°C(°F)								
103	(Slave3) Liquid Pipe Temperature	LiquidPipeTemp_XXX	AI	°C(°F)								
104	(Slave3) Heat Exchanger Temperature	HexTemp_XXX	AI	°C(°F)								
105	(Slave3) Outdoor EEV	OutdoorEEV_XXX	AI	-								
106	(Slave3) Subcool EEV	SubCoolEEV_XXX	AI	-								
107	(Slave3) Hot Gas Valve	HotgasValue_XXX	BI	-	Stop (0)	Start (1)	-	-	-	-	-	-
108	(Slave3) Inverter Discharge Temperature	InverterDischargeTemp_XXX	AI	°C(°F)								
109	(Slave3) Outdoor Temperature	OutdoorTemp_XXX	AI	°C(°F)								
110	(Slave3) Operation Mode	OperationMode_XXX	MI	-	-	Stop (1)	Cool (2)	Heat (3)	-	-	-	-
111-128	Additional Point for Slave3 Outdoor Unit											

## AWHP Object List

One AWHP has the following list of points. Some points may not be supported depending on the product.

Point	Description	Object Name(_XXX : Address)	Object Type	Unit	Text-0	Text-1	Text-2	Text-3	Text-4	Text-5	Text-6
1	On/Off (Setting)	StartStopCommand_XXX	BO	-	Stop (0)	Start (1)	-	-	-	-	-
2	On/Off (Status)	StartStopStatus_XXX	BI	-	Stop (0)	Start (1)	-	-	-	-	-
3	Lock (Setting)	LockCommand_XXX	BO	-	Permit (0)	Prohibit (1)	-	-	-	-	-
4	Lock (Status)	LockStatus_XXX	BI	-	Permit (0)	Prohibit (1)	-	-	-	-	-
5	Operation Mode (Setting)	AirConModeCommand_XXX	MO	-	-	Cool (1)	Heat (2)	Auto (3)	-	-	-
6	Operation Mode (Status)	AirConModeStatus_XXX	MI	-	-	Cool (1)	Heat (2)	Auto (3)	-	-	-
7	Set Room Temperature (Setting)	SetRoomTempCommand_XXX	AV	°C(°F)	16 °C ~ 30 °C (60 °F ~ 86 °F)						
8	Set Room Temperature (Status)	SetRoomTempStatus_XXX	AI	°C(°F)	16 °C ~ 30 °C (60 °F ~ 86 °F)						
9	Set Hot Water Temperature (Setting)	SetHotWaterTempCommand_XXX	AV	°C(°F)	30 °C ~ 80 °C (86 °F ~ 176 °F)						
10	Set Hot Water Temperature (Status)	SetHotWaterTempStatus_XXX	AI	°C(°F)	30 °C ~ 80 °C (86 °F ~ 176 °F)						
11	Set PipeOut Water Temperature (Setting)	SetPipeOutWaterTempCommand_XXX	AV	°C(°F)	6 °C ~ 80 °C (42 °F ~ 176 °F)						
12	Set PipeOut Water Temperature (Status)	SetPipeOutWaterTempStatus_XXX	AI	°C(°F)	6 °C ~ 80 °C (42 °F ~ 176 °F)						
13	Setting Temperature Reference (Air/Water)	AirWaterFlag_XXX	BI	-	Air (0)	Water (1)	-	-	-	-	-
14	Hot Water Only Mode	HotWaterOnlyFlag_XXX	BI	-	Normal (0)	Hot Water Only (1)	-	-	-	-	-
15	Set Temperature (Status)	RoomTemp_XXX	AI	°C(°F)							
16	Alarm	Alarm_XXX	BI	-	Normal (0)	Abnormal (1)	-	-	-	-	-
17	Error Code	MalfunctionCode_XXX	AI	-	Please refer to LG error code list.						
18	HotWater On/Off (Setting)	HotWaterCommand_XXX	BO	-	Stop (0)	Start (1)	-	-	-	-	-
19	HotWater On/Off (Status)	HotWaterStatus_XXX	BI	-	Stop (0)	Start (1)	-	-	-	-	-
20	Pipe Inlet Temperature Status	PipeInTempStatus_XXX	AI	°C(°F)							
21	Water Tank Temperature Status	TankTempStatus_XXX	AI	°C(°F)							
22	Solar Temperature Status	SolarTempStatus_XXX	AI	°C(°F)							
23	Pipe Outlet Temperature tatus	PipeOutTempStatus_XXX	AI	°C(°F)							
24	Accumulated Power Distribution (Status)	Accumulated power(100 Watt)_XXX	AI	100 Watt	Wattage values						



## General Object List

This is the list of BACnet objects provided for the general information. Some points may not be supported depending on the product.

Point	Description	Object Name(_XXX : Address)	Object Type	Unit	Text-0	Text-1	Text-2	Text-3	Text-4	Text-5	Text-6
1	All Unit Run/Stop (Setting)	AllStartStopCommand	BO	-	Stop (0)	Start (1)	-	-	-	-	-
2	All Unit Set Room Temperature (Setting)	AllSetRoomTempCommand	AV	°C(°F)	18 °C ~ 30 °C (64 °F ~ 86 °F)						
3	All Unit Temperature Lock (Setting)	AllTempLockCommand	BO	-	Permit (0)	Prohibit (1)	-	-	-	-	-
4	Total Accumulated Power (Status)	TotalAccumulatedPower	AI	100 Watt	Wattage values						
5	Peak Control Operation (Setting)	PeakStartStopCommand	BO	-	Stop (0)	Start (1)	-	-	-	-	-
6	Peak Control Operation (Status)	PeakStartStopStatus	BI	-	Stop (0)	Start (1)	-	-	-	-	-
7	Peak Shift Time(Setting)	PeakShiftTimeCommand	AV	min	5 min ~ 15 min						
8	Peak Shift Time(Status)	PeakShiftTimeStatus	AI	min	5 min ~ 15 min						
9	Peak Target Ratio(Setting)	PeakTargetCommand	AV	%	0 % ~ 100 %						
10	Peak Target Ratio(Status)	PeakTargetStatus	AI	%	0 % ~ 100 %						
11	Peak Current Running Ratio(Status)	PeakCurrentStatus	AI	%	0 % ~ 100 %						
12	Remote Shutdown(Setting)	RemoteShutDownCommand	BO	-	Normal (0)	Shutdown (1)	-	-	-	-	-
13	Temperature Unit Setting (Setting)	TempUnitCommand	BO	-	°C (0)	°F (1)	-	-	-	-	-
14	Temperature Unit Setting (Status)	TempUnitStatus	BI	-	°C (0)	°F (1)	-	-	-	-	-



## BIBBs

BACnet Interoperability Building Blocks

Alarm and Event Management, Scheduling, Trending and Network Security BIBBs are not supported.

## Data Sharing BIBBs

(☐: Not supported, ■: Supported)

BIBB Type		Supported	Service	Initiate	Execute
DS-RP-A	Data Sharing-ReadProperty-A	☐	ReadProperty	X	
DS-RP-B	Data Sharing-ReadProperty-B	■	ReadProperty		X
DS-RPM-A	Data Sharing-ReadPropertyMultiple-A	☐	ReadPropertyMultiple	X	
DS-RPM-B	Data Sharing-ReadPropertyMultiple-B	■	ReadPropertyMultiple		X
DS-RPC-A	Data Sharing-ReadPropertyConditional-A	☐	ReadPropertyConditional	X	
DS-RPC-B	Data Sharing-ReadPropertyConditional-B	☐	ReadPropertyConditional		X
DS-WP-A	Data Sharing-WriteProperty-A	☐	WriteProperty	X	
DS-WP-B	Data Sharing-WriteProperty-B	■	WriteProperty		X
DS-WPM-A	Data Sharing-WritePropertyMultiple-A	☐	WritePropertyMultiple	X	
DS-WPM-B	Data Sharing-WritePropertyMultiple-B	■	WritePropertyMultiple		X
DS-COV-A	Data Sharing-Change Of Value-A	☐	SubscribeCOV	X	
			ConfirmedCOVNotification		X
			UnconfirmedCOVNotification		X
DS-COV-B	Data Sharing-Change Of Value-B	■	SubscribeCOV		X
			ConfirmedCOVNotification	X	
			UnconfirmedCOVNotification	X	
DS-COVP-A	Data Sharing-Change Of Value Property-A	☐	SubscribeCOVProperty	X	
			ConfirmedCOVNotification		X
			UnconfirmedCOVNotification		X
DS-COVP-B	Data Sharing-Change Of Value Property-B	☐	SubscribeCOVProperty		X
			ConfirmedCOVNotification	X	
			UnconfirmedCOVNotification	X	
DS-COVU-A	Data Sharing-Change Of Value Unsubscribed-A	☐	UnconfirmedCOVNotification		X
DS-COVU-B	Data Sharing-Change Of Value Unsubscribed-B	☐	UnconfirmedCOVNotification	X	

## Device and Network Management BIBBs

(☐: Not supported, ■: Supported)

BIBB Type		Supported	Service	Initiate	Execute
DM-DDB-A	Device Management-Dynamic Device Binding-A	☐	Who-Is	X	
			I-Am		X
DM-DDB-B	Device Management-Dynamic Device Binding-B	■	Who-Is		X
			I-Am	X	
DM-DOB-A	Device Management-Dynamic Object Binding-A	☐	Who-Has	X	
			I-Have		X
DM-DOB-B	Device Management-Dynamic Object Binding-B	■	Who-Has		X

			I-Have	X	
DM-DCC-A	Device Management-DeviceCommunicationControl-A	<input type="checkbox"/>	DeviceCommunicationControl	X	
DM-DCC-B	Device Management-DeviceCommunicationControl-B	<input checked="" type="checkbox"/>	DeviceCommunicationControl		X
DM-TS-A	Device Management-TimeSynchronization-A	<input type="checkbox"/>	TimeSynchronization	X	
DM-TS-B	Device Management-TimeSynchronization-B	<input checked="" type="checkbox"/>	TimeSynchronization		X



## PICS

BACnet Protocol Implementation Conformance Statement

### Vendor Name

LG Electronics Inc.

### Product Name

AC Smart 5

### Product Description

This gateway converts between BACnet IP and RS-485 LGAP (LG Aircon protocol) allowing third party control and monitoring of the LG A/C system.

It has a built in web server that does not require any additional software.

### BACnet Standardized Device Profile (Annex L)

BACnet Application Specific Controller (B-ASC)

### Segmentation Capability

Segmented responses supported Window Size - 64

### Standard Object Types Supported

Object-Type	Dynamically Creatable	Dynamically Deletable	Optional Properties Supported	Writable Properties
Device	No	No	Location, Description, Max Segments Accepted, APDU Segment Timeout, Active COV Subscriptions, Profile Name	N/A
Analog Input	No	No	Description, Reliability, Min Pres Value, Max Pres Value, Resolution, COV Increment	N/A
Analog Value	No	No	Description, Reliability, Resolution, COV Increment	Present_Value
Binary Input	No	No	Description, Reliability, Inactive Text, Active Text	N/A
Binary Output	No	No	Description, Reliability, Inactive Text, Active Text	Present_Value
Binary Value	No	No	Description, Reliability, Inactive Text, Active Text	Present_Value
Multi-State Input	No	No	Description, Reliability, State Text	N/A
Multi-State Output	No	No	Description, Reliability, State Text	Present_Value

### Data Link Layer Options

BACnet IP, (Annex J), Foreign Device - IPv4 only, IPv6 not supported

### Device Address Binding

Static device binding is not supported.

### Character Sets Supported

ANSI x 3.4



## Modbus Commission

Commissioning is the process of verifying the subsystems to achieve the owner's project requirements as intended by the building owner and as designed by the building architects and engineers.

After AC Smart 5 installation, you can check the operation status of the device by using the web function before connection with the BMS system.

Creating of the Points. This is NOT to be done by LG since it is directly related to the BMS side. The BMS engineer is to carry out the engineering of the Point, however LG is responsible for providing the method of how the Points are calculated.

## Precautions

- To use the Modbus feature, you must select **[Settings] > [BACnet/Modbus Setting] > [Modbus TCP enable]** as **Set**.
- In case of installing 2 or more AC Smart 5, you must change **[Settings] > [BACnet/Modbus Setting] > [Vnet Number Setting]** so that the Vnet Numbers are not duplicate among AC Smart 5.
- The Vnet number is used as a Slave ID of the Modbus protocol and can be set to a value from 1 to 247.
- The Read Single Coils command (Function Code 1) can read up to 2,000 commands at a time. The Read Holding Registers command (Function Code 3) can read up to 125 at a time.



## Supported Function Codes

The Modbus function codes supported by AC Smart 5 are as follows:

Refer to the Register List page for controlled/monitored items supported by each function code.

- 0x01
- 0x03
- 0x05
- 0x06



## Modbus Register List

It describes the Modbus Register List provided by AC Smart 5.

- Definition of Register Address
- Indoor Unit Register List
- Ventilation Register List
- AHU Register List
- AWHP Register List

### Definition of Register Address

The Register Address of each device is assigned as follows.

- Protocol Configuration

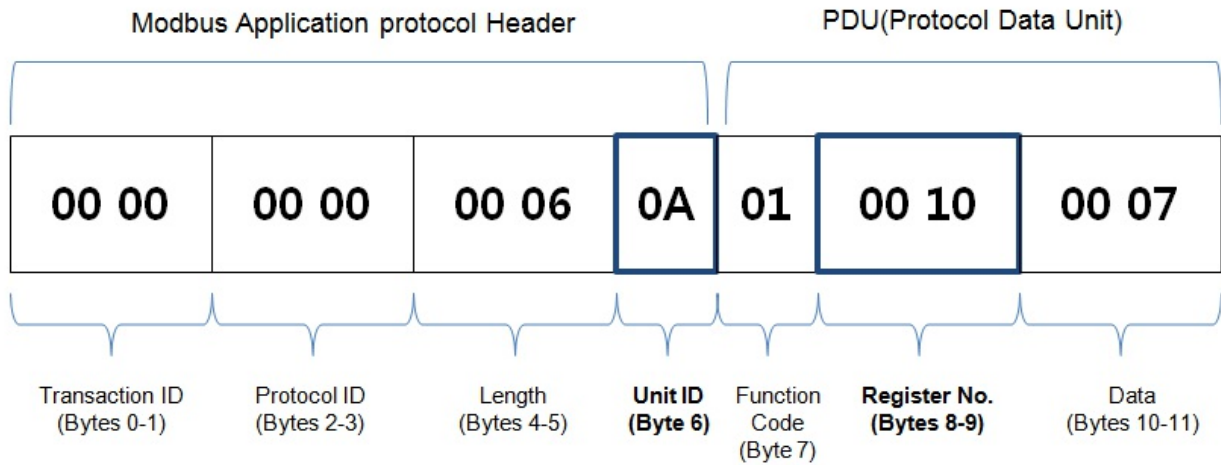

Unit ID : Vnet Number, default value 10

- Register No.

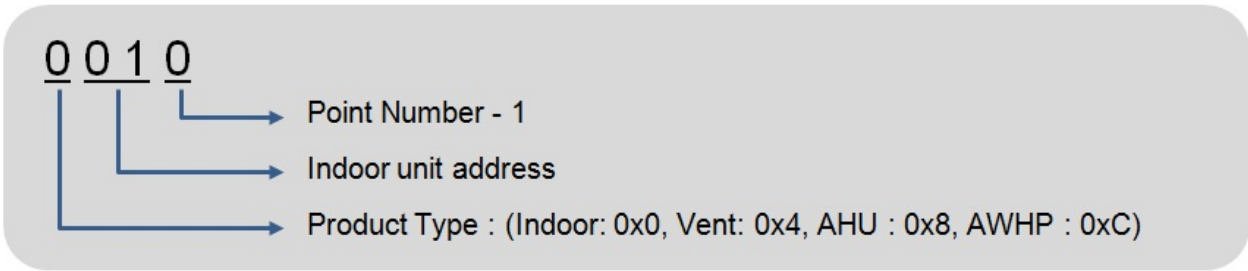

### Example of Register Address

Description of Register	Product Type (Hexadecimal)	Product Address (Hexadecimal)	Point (Hexadecimal)	Function Code(Hexadecimal)	Register Address (Hexadecimal)
IDU Address 0x00, On/Off	0x0	0x00	0x1	0x1 / 0x5	0x0000
IDU Address 0x00, Operation Mode	0x0	0x00	0x1	0x3 / 0x6	0x0000
IDU Address 0x1B, On/Off	0x0	0x1B	0x1	0x1 / 0x5	0x01B0
IDU Address 0x1B, Operation Mode	0x0	0x1B	0x1	0x3 / 0x6	0x01B0
Vent Address 0x00, On/Off	0x4	0x00	0x1	0x1 / 0x5	0x4000
Vent Address 0x00, Operation Mode	0x4	0x00	0x1	0x3 / 0x6	0x4000
Vent Address 0x1B, On/Off	0x4	0x1B	0x1	0x1 / 0x5	0x41B0
Vent Address 0x1B, Operation Mode	0x4	0x1B	0x1	0x3 / 0x6	0x41B0
AHU Address 0x00, On/Off	0x8	0x00	0x1	0x1 / 0x5	0x8000
AHU Address 0x00, Operation Mode	0x8	0x00	0x1	0x3 / 0x6	0x8000
AHU Address 0x00, Current OA Damper	0x8	0x01	0x1	0x3	0x8010
AHU Address 0x0F, On/Off	0x8	0x1E	0x1	0x1 / 0x5	0x81E0

AHU Address 0x0F, Operation Mode	0x8	0x1E	0x1	0x3 / 0x6	0x81E0
AHU Address 0x0F, Current OA Damper	0x8	0x1F	0x1	0x3	0x81F0
AWHP Address 0x00, On/Off	0xC	0x00	0x1	0x1 / 0x5	0xC000
AWHP Address 0x00, Operation Mode	0xC	0x00	0x1	0x3 / 0x6	0xC000
AWHP Address 0x0F, On/Off	0xC	0x0F	0x1	0x1 / 0x5	0xC0F0
AWHP Address 0x0F, Operation Mode	0xC	0x0F	0x1	0x3 / 0x6	0xC0F0



## Indoor Unit Register List

One Indoor unit has the following list of points. Some points may not be supported depending on the product.

Point	Description	Function Code	Unit	Text-0	Text-1	Text-2	Text-3	Text-4	Text-5	Text-6
1	On/Off	01/05	-	Stop (0)	Start (1)	-	-	-	-	-
2	Swing	01/05	-	Stop (0)	Start (1)	-	-	-	-	-
3	Lock	01/05	-	Permit (0)	Prohibit (1)	-	-	-	-	-
4	Mode Lock	01/05	-	Permit (0)	Prohibit (1)	-	-	-	-	-
5	Fan Lock	01/05	-	Permit (0)	Prohibit (1)	-	-	-	-	-
6	Temp Lock	01/05	-	Permit (0)	Prohibit (1)	-	-	-	-	-
7	Alarm	01	-	Normal (0)	Abnormal (1)	-	-	-	-	-
1	Operation Mode	03/06	-	-	Cool (1)	Dry (2)	Fan (3)	Auto (4)	Heat (5)	-
2	Fan Speed	03/06	-	-	Low (1)	Middle (2)	High (3)	Auto (4)	-	-
3	Set Room Temperature	03/06	°C	16 °C ~ 30 °C (60 °F ~ 86 °F)						
4	Set Upper Temperature	03/06	°C	18 °C ~ 30 °C (64 °F ~ 86 °F)						
5	Set Lower Temperature	03/06	°C	16 °C ~ 30 °C (60 °F ~ 86 °F)						
6	Room Temperature	03	°C							
7	Error Code	03	-	Please refer to LG error code list.						
8	Accumulated Power(LOW)	03	-	Accumulated Power Value(100 Watt) = Accumulated Power(HIGH) X 65536 + Accumulated Power(LOW)						
9	Accumulated Power(HIGH)	03	-							
10	Accumulated Gas(LOW)	03	-							
11	Accumulated Gas(HIGH)	03	-	Accumulated Gas Value(100 Liter) = Accumulated Gas(HIGH) X 65536 + Accumulated Gas(LOW)						



## Ventilation Register List

One Indoor unit has the following list of points. Some points may not be supported depending on the product.

Point	Description	Function Code	Unit	Text-0	Text-1	Text-2	Text-3	Text-4	Text-5	Text-6
1	On/Off	01/05	-	Stop (0)	Start (1)	-	-	-	-	-
2	Lock	01/05	-	Permit (0)	Prohibit (1)	-	-	-	-	-
3	Filter	01/05	-	Off (0)	On (1)	-	-	-	-	-
4	Alarm	01	-	Normal (0)	Abnormal (1)	-	-	-	-	-
5	AC ON/OFF	01/05	-	Stop (0)	Start (1)	-	-	-	-	-
6	AC Humidify	01/05	-	Stop (0)	Start (1)	-	-	-	-	-
1	Operation Mode	03/06	-	-	Heat Exchange (1)	Auto (2)	Normal (3)	-	-	-
2	Fan Speed	03/06	-	-	Low (1)	High (2)	Super High (3)	Auto (4)	-	-
3	User Mode	03/06	-	-	Quick fresh (1)	Energy saving (2)	Clear (3)	-	-	-
4	Error Code	03	-	Please refer to LG error code list.						
5	AC Operation Mode	03/06	-	-	Cool (1)	Auto (2)	Heat (3)	-	-	-
6	Set Room Temperature	03/06	°C	16 °C ~ 30 °C (60 °F ~ 86 °F)						



## AHU Register List

One AHU has the following list of points. Some points may not be supported depending on the product.

Due to the limited number of points, One AHU device uses two product addresses. Refer to the Definition of Register Address page for the detail information.

Point	Description	Function Code	Unit	Text-0	Text-1	Text-2	Text-3	Text-4	Text-5	Text-6
Product Address X 2										
1	On/Off	01/05	-	Stop (0)	Start (1)	-	-	-	-	-
2	Lock	01/05	-	Permit (0)	Prohibit (1)	-	-	-	-	-
3	Filter	01	-	Off (0)	On (1)	-	-	-	-	-
4	FireAlarm	01/05	-	Off (0)	On (1)	-	-	-	-	-
5	Humidity Oper	01/05	-	Stop (0)	Start (1)	-	-	-	-	-
6	Auto Ventilation ON/OFF	01/05	-	Stop (0)	Start (1)	-	-	-	-	-
7	Humidify ON/OFF Status	01	-	Stop (0)	Start (1)	-	-	-	-	-
8	Heater ON/OFF Status	01	-	Stop (0)	Start (1)	-	-	-	-	-
9	Ventilator FAN ON/OFF	01	-	Stop (0)	Start (1)	-	-	-	-	-
10	Supply Unit FAN ON/OFF	01	-	Stop (0)	Start (1)	-	-	-	-	-
11	Alarm	01	-	Normal (0)	Abnormal (1)	-	-	-	-	-
1	Operation Mode	03/06	-	-	Cool (1)	Dry (2)	Fan (3)	Energy saving (4)	Heat (5)	-
2	Set Room Temperature	03/06	°C	16 °C ~ 30 °C (60 °F ~ 86 °F)						
3	Supply Unit Temperature	03	°C							
4	Outdoor Unit Temperature	03	°C							
5	Ventilation Unit Temperature	03	°C							
6	Mix Unit Temperature	03	°C							
7	Set Humidity	03/06	%	40 % ~ 60 %						
8	Supply Unit Humidity	03	%							
9	Outdoor Unit Humidity	03	%							
10	Ventilation Unit Humidity	03	%							
11	CO2 Value	03	-	0~255 (Real Value = Value*10, Example : In case Value is 20, CO2 is 20*10=200ppm)						
12	Error Code	03	-	Please refer to LG error code list.						
Product Address X 2 + 1										
1	Current OA Damper	03	°							
2	Current EA Damper	03	°							
3	Current Mix Damper	03	°							
4	Cooling OA Damper	03/06	°	0 ° ~ 90 °						
5	Cooling EA Damper	03/06	°	0 ° ~ 90 °						
6	Cooling Mix Damper	03/06	°	0 ° ~ 90 °						
7	Heating OA Damper	03/06	°	0 ° ~ 90 °						
8	Heating EA Damper	03/06	°	0 ° ~ 90 °						
9	Heating Mix Damper	03/06	°	0 ° ~ 90 °						
10	FAN OA Damper	03/06	°	0 ° ~ 90 °						
11	FAN EA Damper	03/06	°	0 ° ~ 90 °						
12	FAN Mix Damper	03/06	°	0 ° ~ 90 °						



## AWHP Register List

One AWHP has the following list of points. Some points may not be supported depending on the product.

Point	Description	Function Code	Unit	Text-0	Text-1	Text-2	Text-3	Text-4	Text-5	Text-6
1	On/Off	01/05	-	Stop (0)	Start (1)	-	-	-	-	-
2	Lock	01/05	-	Permit (0)	Prohibit (1)	-	-	-	-	-
3	Setting Temperature Reference (Air/Water)	01	-	Air (0)	Water (1)	-	-	-	-	-
4	Set Hot Water Temperature	01	-	Normal (0)	Hot Water Only (1)	-	-	-	-	-
5	Alarm	01	-	Normal (0)	Abnormal (1)	-	-	-	-	-
6	HotWater On/Off	01/05	-	Stop (0)	Start (1)	-	-	-	-	-
1	Operation Mode	03/06	-	-	Cool (1)	Heat (2)	Auto (3)	-	-	-
2	Set Room Temperature	03/06	°C	16 °C ~ 30 °C (60 °F ~ 86 °F)						
3	Hot Water Only Mode	03/06	°C	30 °C ~ 80 °C (86 °F ~ 176 °F)						
4	Set PipeOut Water Temperature	03/06	°C	6 °C ~ 80 °C (42 °F ~ 176 °F)						
5	Room Temperature	03	°C							
6	Error Code	03	-	Please refer to LG error code list.						
7	Pipe Inlet Temperature Status	03	°C							
8	Water Tank Temperature Status	03	°C							
9	Solar Temperature Status	03	°C							
10	Pipe Outlet Temperature tatus	03	°C							

## LGE Open Source Software Notice

OSSNotice-845\_AC Smart 5\_1.03.1\_180220

This product from LG Electronics, Inc. ("LGE") contains the open source software detailed below. Please refer to the indicated open source licenses (as are included following this notice) for the terms and conditions of their use.

Open Source	License	Copyright
<a href="#">alsa-lib 1.0.28</a>	<a href="#">LGPL-2.1</a>	Copyright (c) 2000 by Abramo Bagnara <abramo@alsa-project.org>, Jaroslav Kysela <perex@perex.cz>
<a href="#">alsa-utils 1.0.28</a>	<a href="#">GPL-2.0</a>	
<a href="#">apmd 3.2.2-14</a>	<a href="#">GPL-2.0</a>	Copyright (c) 1996, Rik E. Faith Copyright (c) 1999, Avery Pennarun
<a href="#">ATK 2.14.0</a>	<a href="#">LGPL-2.1</a>	
<a href="#">avahi 0.6.31</a>	<a href="#">LGPL-2.1</a>	
<a href="#">bash 3.2.48</a>	<a href="#">GPL-2.0</a>	Copyright (c) 2007, 2009, 2011, 2014 Free Software Foundation, Inc.
<a href="#">BusyBox 1.23.1</a>	<a href="#">GPL-2.0</a>	Copyright (c) 1999-2004 by Erik Andersen. Copyright (c) 2005-2006 Rob Landley
<a href="#">cairo 1.12.18</a>	<a href="#">LGPL-2.1</a>	Copyright (c) 2005 Red Hat, Inc. Copyright (c) 2004 Carl Worth Copyright (c) 2009 Chris Wilson
<a href="#">coreutils 6.9</a>	<a href="#">GPL-2.0</a>	
		Copyright (c) 2009 Thomas

<a href="#">cpufrequtils 008</a>	<a href="#">GPL-2.0</a>	Renninger <trenn@suse.de>, Novell Inc. Copyright (c) 2008 Christian Kornacker <ckornacker@suse.de> Copyright (c) 2002-2003, by Mike Gleason, NcFTP Software.
<a href="#">cryptodev-linux 1.6</a>	<a href="#">GPL-2.0</a>	Copyright (c) 2004 Michal Ludvig <mludvig@logix.net.nz>, SuSE Labs Copyright (c) Nikos Mavrogiannopoulos Copyright (c) Michael Weiser Copyright (c) Phil Sutter Copyright (c) Dmitry Kasatkin
<a href="#">DevIL 1.7.8</a>	<a href="#">LGPL-2.1</a>	Copyright (c) 2000-2009, Denton Woods
<a href="#">dosfstools 2.11</a>	<a href="#">GPL-2.0</a>	(c) 2004-2015 Canonical Ltd
<a href="#">e2fsprogs 1.42.9</a>	<a href="#">GPL-2.0</a>	Copyright 1995, 1996, 1997, 1998, 1999, 2000, 2001, 2002, 2003, 2004, 2005, 2006, 2007, 2008, 2009, 2010 by Theodore Ts'o
		Copyright (C) 1998 David S. Miller (davem@dm.cobaltmicro.com) Portions Copyright 2001 Sun Microsystems Kernel 2.4 update Copyright 2001 Jeff Garzik Wake-on-LAN,natsemi,misc support by Tim Hockin Portions Copyright 2002 Intel Portions Copyright (C) Sun Microsystems 2008 do_test support by Eli Kupermann

<a href="#">ethtool 3.16</a>	<a href="#">GPL-2.0</a>	<p>ETHTOOL_PHYS_ID support by Chris Leech</p> <p>e1000 support by Scott Feldman</p> <p>e100 support by Wen Tao</p> <p>ixgb support by Nicholas Nunley</p> <p>amd8111e support by Reeja John</p> <p>long arguments by Andi Kleen.</p> <p>SMSC LAN911x support by Steve Glendinning</p> <p>Rx Network Flow Control configuration support</p> <p>Various features by Ben Hutchings ;</p> <p>Copyright 2009, 2010 Solarflare Communications</p> <p>MDI-X set support by Jesse Brandeburg</p> <p>Copyright 2012 Intel Corporation</p>
<a href="#">fbset 2.1</a>	<a href="#">GPL-2.0</a>	Copyright (c) 1995-1998, Geert Uytterhoeven
<a href="#">freescale-galcore 5.0.11.p8.4</a>	<a href="#">GPL-2.0</a>	Copyright (c) 2005-2016, Vivante Corporation
<a href="#">fsl-alsa-plugins 1.0.25</a>	<a href="#">GPL-2.0</a>	Copyright (c) 2012, Freescale Semiconductor, Inc.
<a href="#">gconf 3.2.6</a>	<a href="#">LGPL-2.1</a>	Copyright (c) 1999, 2000 Red Hat Inc
		<p>Copyright (C) 1995-1997 Peter Mattis, Spencer Kimball and Josh MacDonald</p> <p>Copyright (C) 1999 The Free Software Foundation</p> <p>Copyright (C) 2000 Red Hat, Inc</p> <p>Copyright (C) 2008 Dominic Lachowicz</p> <p>Copyright (C) 2008 Alberto Ruiz</p>

<a href="#">gdk-pixbuf 2.30.8</a>	<a href="#">LGPL-2.1</a>	Copyright (C) 2004 Matthias Clasen <mclasen@redhat.com> Copyright (C) 2005 Imendio AB Copyright (C) 2001-2002 convergence integrated media GmbH Copyright (C) 2002 convergence GmbH
<a href="#">GLib 2.42.1</a>	<a href="#">LGPL-2.1</a>	Copyright (c) 1995-1997 Peter Mattis, Spencer Kimball and Josh MacDonald
<a href="#">glibc 2.21</a>	<a href="#">GPL-2.0</a> <a href="#">LGPL-2.1</a>	Copyright (C) 1989-2013 Free Software Foundation, Inc.
<a href="#">Gstreamer 1.4.5</a>	<a href="#">LGPL-2.1</a>	
<a href="#">GTK+ 2.24.25</a>	<a href="#">LGPL-2.1</a>	
<a href="#">i2c-tools 3.1.1</a>	<a href="#">GPL-2.0</a>	
<a href="#">Imx-kobs 5.3</a>	<a href="#">GPL-2.0</a>	Copyright (c) 2008-2011 Freescale Semiconductor, Inc. Copyright (c) 2008 by Embedded Alley Solution Inc. Copyright (c) 2003, Dr Brian Gladman <brg@gladman.me.uk>, Worcester, UK.
<a href="#">iproute2 3.17.0</a>	<a href="#">GPL-2.0</a>	Copyright (C)2006 USAGI/WIDE Project Copyright (c) 2008, Intel Corporation. Copyright (C) 2012 Eric Dumazet <edumazet@google.com>
<a href="#">iptables 1.4.21</a>	<a href="#">GPL-2.0</a>	
<a href="#">kexec 2.0.9</a>	<a href="#">GPL-2.0</a>	

<a href="#">kmod 19</a>	<a href="#">LGPL-2.1</a>	Copyright (c) 1994-2013 Free Software Foundation, Inc.
<a href="#">libdaemon 0.14</a>	<a href="#">LGPL-2.1</a>	
<a href="#">libexif 0.6.21</a>	<a href="#">LGPL-2.1</a>	
<a href="#">libsfs 2.1.0</a>	<a href="#">LGPL-2.1</a>	
<a href="#">libusb 1.0.19</a>	<a href="#">LGPL-2.1</a>	Copyright (c) 2008 Daniel Drake <dsd@gentoo.org> Copyright (c) 2000-2003 Johannes Erdfelt <johannes@erdfelt.com>
<a href="#">Linux Kernel 3.14.52</a>	<a href="#">GPL-2.0</a>	
<a href="#">matchbox-terminal</a>	<a href="#">GPL-2.0</a>	
<a href="#">matchbox-wm 1.2</a>	<a href="#">GPL-2.0</a>	Copyright (c) 2002, 2004, 2005 OpenedHand Ltd
<a href="#">memtester 4.1.3</a>	<a href="#">GPL-2.0</a>	Copyright (c) 2004-2010 Charles Cazabon <charlesc- memtester@pyropus.ca>
<a href="#">node-firebird 0.7.2</a>	<a href="#">MPL-2.0</a>	
<a href="#">nspr 4.10.8</a>	<a href="#">MPL-2.0</a>	Copyright (c) 2005 Sun Microsystems, Inc. Copyright (c) 1998 Netscape Communications Corporation.
<a href="#">nss 3.17.3</a>	<a href="#">MPL-2.0</a>	
<a href="#">nss-mdns 0.10</a>	<a href="#">LGPL-2.1</a>	Copyright 2004-2007 Lennart Poettering <mzaffzqaf (at) 0pointer (dot) de>
<a href="#">opkg 0.2.4</a>	<a href="#">GPL-2.0</a>	Florian Boor Copyright (c) 2003 kernel concepts  Carl D. Worth Copyright (c) 2001 University of

		Copyright (c) 2001 University of Southern California
<a href="#">pango 1.36.8</a>	<a href="#">LGPL-2.1</a>	Copyright (c) 1999 Red Hat Software
<a href="#">procps 3.3.10</a>	<a href="#">GPL-2.0</a>	
<a href="#">proftpd 1.3.5</a>	<a href="#">GPL-2.0</a>	Copyright (c) 1997, 1998 Public Flood Software Copyright (c) 1999, 2000 MacGyver aka Habeeb J. Dihu <macgyver@tos.net> Copyright (c) 2001-2011 The ProFTPD Project team
<a href="#">shared-mime-info 1.3</a>	<a href="#">GPL-2.0</a>	
<a href="#">startup-notification 0.12</a>	<a href="#">LGPL-2.1</a>	Copyright (c) 2002, Red Hat, Inc. Copyright (c) 2002, 2009, Julien Danjou
<a href="#">sysfsutils 2.1.0</a>	<a href="#">GPL-2.0</a>	Copyright (c) Ananth Mavinakayanahalli Copyright (c) Daniel Stekloff Copyright (c) Mohan Kumar Copyright (c) Nitin Vashisth
<a href="#">sysstat 11.0.2</a>	<a href="#">GPL-2.0</a>	
<a href="#">sysvinit 2.88dsf</a>	<a href="#">GPL-2.0</a>	Copyright (c) 1991-2004 Miquel van Smoorenburg
<a href="#">U-Boot</a>	<a href="#">GPL-2.0</a>	Copyright (c) 2002-2015 by DENX Software Engineering
<a href="#">udev 182</a>	<a href="#">GPL-2.0</a>	
<a href="#">usbutils 007</a>	<a href="#">GPL-2.0</a>	
<a href="#">Util-Linux 2.25.2</a>	<a href="#">GPL-2.0</a>	
<a href="#">vte 0.28.2</a>	<a href="#">LGPL-2.1</a>	Copyright (c) 2001-2004, Red Hat, Inc.

The source code for the above may be obtained free of charge from LGE at <http://opensource.lge.com>. LGE will also provide open source code to you on CD-ROM for a charge covering the cost of performing such distribution (such as the cost of media, shipping, and handling) upon email request to [opensource@lge.com](mailto:opensource@lge.com). This offer is valid for a period of three years after our last shipment of this product. This offer is valid to anyone in receipt of this information.

Please be informed that LG Electronics, Inc. products may contain open source software listed in the tables below.

Open Source	License	Copyright
<a href="#">angular-cookies 0.12.0</a>	<a href="#">MIT</a>	
<a href="#">angular-local-storage 0.2.7</a>	<a href="#">MIT</a>	Copyright (c) 2016 Gregory Pike
<a href="#">angular-moment 0.10.3</a>	<a href="#">MIT</a>	Copyright (c) 2013-2015 Uri Shaked and contributors
<a href="#">angular-slider 0.2.15</a>	<a href="#">MIT</a>	Copyright (c) 2014 PopSugar <cbailey@popsugar.com>
<a href="#">angular-translate 2.8.1</a>	<a href="#">MIT</a>	Copyright (c) <2014> <pascal.precht@gmail.com>
<a href="#">angular-ui-router.statehelper 1.3.1</a>	<a href="#">MIT</a>	Copyright (c) 2014 Mark Lagendijk
<a href="#">angular-ui-tree 2.13.0</a>	<a href="#">MIT</a>	
<a href="#">angular-useragent-parser 0.1.0</a>	<a href="#">MIT</a>	Copyright (c) 2015 Daniel Campos
<a href="#">angular-virtual-keyboard 0.4.3</a>	<a href="#">MIT</a>	Copyright (c) 2015 Daniel Campos
<a href="#">angular-xml 2.2.2</a>	<a href="#">MIT</a>	Copyright (c) 2013-2015 John Wright <a href="http://i-g-w.info">http://i-g-w.info</a>

<a href="#">AngularJS 1.5.11</a>	<a href="#">MIT</a>	Copyright (c) 2010-2017 Google, Inc. http://angularjs.org
<a href="#">AngularJS 1.4.14</a>	<a href="#">MIT</a>	Copyright (c) 2010-2015 Google, Inc. http://angularjs.org
<a href="#">angularjs-slider 0.1.36</a>	<a href="#">MIT</a>	Copyright (c) 2013 Rafal Zajac <rzajac@gmail.com>
<a href="#">AngularUI Router 0.2.18</a>	<a href="#">MIT</a>	Copyright (c) 2013-2015 The AngularUI Team, Karsten Sperling
<a href="#">Apache CouchDB</a>	<a href="#">AFL-2.0</a>	Copyright (c) 2009-2016 The Apache Software Foundation
<a href="#">async 1.5.2</a>	<a href="#">MIT</a>	Copyright (c) 2010-2014 Caolan McMahon
<a href="#">body-parser 1.17.2</a>	<a href="#">MIT</a>	Copyright (c) 2014 Jonathan Ong <me@jongleberry.com> Copyright (c) 2014-2015 Douglas Christopher Wilson <doug@somethingdoug.com>
<a href="#">bower 1.8.0</a>	<a href="#">MIT</a>	Copyright (c) 2016 Twitter and other contributors
<a href="#">bower-angular-translate-loader-static-files 2.8.1</a>	<a href="#">MIT</a>	Copyright (c) 2015 The angular-translate team, Pascal Precht
<a href="#">browser-filesaver 1.1.1</a>	<a href="#">MIT</a>	Copyright (c) 2015 Eli Grey
<a href="#">bzip2 1.0.6</a>	<a href="#">bzip2-1.0.6</a>	
<a href="#">Chromium 40.0.2214.91</a>	<a href="#">BSD-3-Clause</a>	Copyright 2014 The Chromium Authors Copyright (c) 2006-2009 The Chromium OS Authors
<a href="#">composable-middleware 0.3.0</a>	<a href="#">MIT</a>	Copyright (c) 2013 Randy McLaughlin
		Copyright(c) 2010 Sencha Inc.

<a href="#">compression 1.6.2</a>	<a href="#">MIT</a>	Copyright(c) 2011 TJ Holowaychuk Copyright(c) 2014 Jonathan Ong Copyright(c) 2014-2015 Douglas Christopher Wilson
<a href="#">connect-livereload 0.5.4</a>	<a href="#">MIT</a>	Copyright (c) 2013 intesso
<a href="#">connect-multiparty 2.0.0</a>	<a href="#">MIT</a>	Copyright (c) 2010 Sencha Inc. Copyright (c) 2011 TJ Holowaychuk Copyright (c) 2013 Andrew Kelley
<a href="#">cookie-parser 1.4.3</a>	<a href="#">MIT</a>	Copyright (c) 2014 TJ Holowaychuk <tj@vision-media.ca>
<a href="#">Crypto-js 3.1.9</a>	<a href="#">MIT</a>	Copyright (c) 2009-2013 Jeff Mott Copyright (c) 2013-2016 Evan Vosberg
<a href="#">Crypto-js 3.1.6</a>	<a href="#">MIT</a>	Copyright (c) 2009-2013 Jeff Mott Copyright (c) 2013-2016 Evan Vosberg
<a href="#">curl</a>	<a href="#">curl</a>	Copyright (c) 1996 - 2008, Daniel Stenberg, <daniel@haxx.se>.
<a href="#">d3 3.5.17</a>	<a href="#">BSD-3-Clause</a>	Copyright (c) 2010-2016, Michael Bostock
<a href="#">dbus 1.8.10</a>	<a href="#">AFL-2.1</a>	Copyright (C) 2003, 2004 Red Hat, Inc.
<a href="#">dbus-glib 0.102</a>	<a href="#">AFL-2.1</a>	
<a href="#">device.js 0.2.7</a>	<a href="#">MIT</a>	Copyright (c) 2015 Matthew Hudson
<a href="#">dhcpcd</a>	<a href="#">BSD-2-Clause</a>	
<a href="#">dropbear 2014.66</a>	<a href="#">MIT</a>	Copyright (c) 2002-2014 Matt Johnston Portions copyright (c) 2004 Mihnea Stoenescu
<a href="#">ejs 2.5.6</a>	<a href="#">Apache-2.0</a>	Copyright 2012 Matthew Eernisse (mde@fleegix.org)
<a href="#">errorhandler 1.5.0</a>	<a href="#">MIT</a>	Copyright (c) 2014 Jonathan Ong <me@jongleberry.com> Copyright (c) 2014-2015 Douglas Christopher Wilson

		Christopher Wilson <doug@somethingdoug.com>
<a href="#">ExcelJS 0.2.46</a>	<a href="#">MIT</a>	Copyright (c) 2014-2017 Guyon Roche
<a href="#">expat 2.1.0</a>	<a href="#">MIT</a>	Copyright (c) 1998, 1999, 2000 Thai Open Source Software Center Ltd and Clark Cooper Copyright (c) 2001, 2002, 2003, 2004, 2005, 2006 Expat maintainers.
<a href="#">express 4.15.3</a>	<a href="#">MIT</a>	Copyright (c) 2009-2014 TJ Holowaychuk <tj@vision-media.ca> Copyright (c) 2013-2014 Roman Shtylman <shtylman+expressjs@gmail.com> Copyright (c) 2014-2015 Douglas Christopher Wilson <doug@somethingdoug.com>
<a href="#">express-session 1.15.3</a>	<a href="#">MIT</a>	Copyright (c) 2010 Sencha Inc. Copyright (c) 2011 TJ Holowaychuk <tj@vision-media.ca> Copyright (c) 2014-2015 Douglas Christopher Wilson <doug@somethingdoug.com>
<a href="#">file 5.22</a>	<a href="#">BSD-like License (file)</a>	Copyright (c) Ian F. Darwin 1986, 1987, 1989, 1990, 1991, 1992, 1994, 1995. Software written by Ian F. Darwin and others; maintained 1994- Christos Zoulas.
<a href="#">file-type 4.3.0</a>	<a href="#">MIT</a>	Copyright (c) Sindre Sorhus <sindresorhus@gmail.com> (sindresorhus.com)
<a href="#">fontconfig 2.11.1</a>	<a href="#">MIT-like License (fontconfig)</a>	Copyright (c) 2000,2001,2002,2003,2004,2006,2007 Keith Packard Copyright (c) 2005 Patrick Lam Copyright (c) 2009 Roozbeh Pournader Copyright (c) 2008,2009 Red Hat, Inc. Copyright (c) 2008 Danilo Šegan Copyright (c) 2012 Google, Inc.

<a href="#">forever 0.15.3</a>	<a href="#">MIT</a>	Copyright (C) 2010 Charlie Robbins & the Contributors
<a href="#">freescale-fsl-gpu-sdk 2.2.1</a>	<a href="#">Apache-2.0</a>	
<a href="#">freescale-xserver 5.0.11</a>	<a href="#">MIT</a>	Copyright (c) 2013-2014, Freescale Semiconductor, Inc. All Rights Reserved. Copyright (c) 2012-2015, Vivante Corporation, Santa Clara, California. Copyright (c) 2011,2013 Freescale Semiconductor, Inc. All Rights Reserved. Copyright (c) 1998-1999, Precision Insight, Inc., Cedar Park, Texas. Copyright (c) 2000, VA Linux Systems, Inc. Copyright (c) 2012, Red Hat, Inc.
<a href="#">freetype 2.5.4</a>	<a href="#">FTL</a>	Copyright (c) 2006-2011 by David Turner, Robert Wilhelm, and Werner Lemberg.
<a href="#">gulp 3.9.1</a>	<a href="#">MIT</a>	Copyright (c) 2013-2016 Fractal <contact@wearefractal.com>
<a href="#">gulp-clean 0.3.2</a>	<a href="#">MIT</a>	Copyright (c) Peter Vilja
<a href="#">gulp-clean-css 2.4.0</a>	<a href="#">MIT</a>	Copyright (c) 2016 scniro <scniro@outlook.com>
<a href="#">gulp-concat 2.6.1</a>	<a href="#">MIT</a>	Copyright (c) 2016 Contra
<a href="#">gulp-concat-css 2.3.0</a>	<a href="#">MIT</a>	Copyright (c) 2014 Mario Casciaro
<a href="#">gulp-inject 1.5.0</a>	<a href="#">MIT</a>	
<a href="#">gulp-inject-string 0.0.2</a>	<a href="#">MIT</a>	Copyright (c) 2014 Mike
<a href="#">gulp-live-server 0.0.28</a>	<a href="#">MIT</a>	
<a href="#">gulp-ng-config 1.4.0</a>	<a href="#">MIT</a>	Copyright (c) 2015 Atticus White
<a href="#">gulp-ng-constant 0.2.0</a>	<a href="#">MIT</a>	Copyright (c) 2014 Arturo Guzman

<a href="#">gulp-rename 1.2.2</a>	<a href="#">MIT</a>	Copyright 2013 Hector Guillermo Parra Alvarez
<a href="#">gulp-replace 0.5.4</a>	<a href="#">MIT</a>	Copyright (c) 2013 Larry Davis
<a href="#">gulp-sass 2.3.2</a>	<a href="#">MIT</a>	Copyright (c) 2013 David Manning
<a href="#">gulp-strip-debug 1.1.0</a>	<a href="#">MIT</a>	Copyright (c) Sindre Sorhus <sindresorhus@gmail.com> (sindresorhus.com)
<a href="#">gulp-uglify 1.5.4</a>	<a href="#">MIT</a>	Copyright (c) 2013-2014 Terin Stock <terinjokes@gmail.com>
<a href="#">gulp-util 2.2.20</a>	<a href="#">MIT</a>	Copyright (c) 2014 Fractal <contact@wearefractal.com>
<a href="#">hangul.js 0.2.1</a>	<a href="#">MIT</a>	Copyright (c) 2012-2016 Jaemin Jo
<a href="#">HarfBuzz 0.9.38</a>	<a href="#">MIT-like License (HarfBuzz)</a>	Copyright (c) 2010,2011,2012, Google, Inc. Copyright (c) 2012, Mozilla Foundation Copyright (c) 2011, Codethink Limited Copyright (c) 2008,2010, Nokia Corporation and/or its subsidiary(-ies) Copyright (c) 2009, Keith Stribley Copyright (c) 2009, Martin Hosken and SIL International Copyright (c) 2007, Chris Wilson Copyright (c) 2006, Behdad Esfahbod Copyright (c) 2005, David Turner Copyright (c) 2004,2007,2008,2009,2010, Red Hat, Inc. Copyright (c) 1998-2004, David Turner and Werner Lemberg
<a href="#">howler.js 2.0.4</a>	<a href="#">MIT</a>	Copyright (c) 2013-2017 James Simpson and GoldFire Studios, Inc.
<a href="#">icu 54.1</a>	<a href="#">ICU</a>	Copyright (c) 1995-2010 International Business Machines Corporation and others
<a href="#">jpeg 8d</a>	<a href="#">IJG</a>	copyright (C) 1991-1998, Thomas G. Lane.
		Copyright (c) 2005-2014 jQuery Foundation

<a href="#">jquery 2.1.4</a>	<a href="#">MIT</a>	Copyright (c) 2005, 2014 JQuery Foundation and other contributors, <a href="https://jquery.org/">https://jquery.org/</a>
<a href="#">JSZIP 2.6.0</a>	<a href="#">MIT</a>	Copyright (c) 2009-2014 Stuart Knightley, David Duponchel, Franz Buchinger, António Afonso
<a href="#">libcap 2.24</a>	<a href="#">BSD-3-Clause</a>	Copyright (c) The Regents of the University of California
<a href="#">libdmx 1.1.3</a>	<a href="#">MIT</a>	Copyright (c) 2002-2004 Red Hat Inc., Durham, North Carolina.
<a href="#">libdrm 2.4.59</a>	<a href="#">MIT</a>	Copyright (c) 2009 VMware, Inc., Palo Alto, CA., USA Copyright (C) 2013 Rob Clark <robclark@freedesktop.org> Copyright 2012 Red Hat Inc. Copyright (c) 2014 NVIDIA Corporation Copyright 2014 Advanced Micro Devices, Inc. Copyright 2008 Tungsten Graphics Jakob Bornecrantz <jakob@tungstengraphics.com> Copyright 2008 Intel Corporation Jesse Barnes <jesse.barnes@intel.com>
<a href="#">libedit 20130712-3.1</a>	<a href="#">BSD-3-Clause</a>	Copyright (c) 1992, 1993 The Regents of the University of California
<a href="#">libevdev 1.3</a>	<a href="#">MIT</a>	Copyright (c) 2013 Red Hat, Inc. Copyright (c) 2013 David Herrmann <dh.herrmann@gmail.com>
<a href="#">libffi 3.2.1</a>	<a href="#">MIT</a>	Copyright (c) 1996-2012 Anthony Green, Red Hat, Inc and others.
<a href="#">libfontenc 1.1.2</a>	<a href="#">MIT</a>	Copyright (c) 1998-2001 by Juliusz Chroboczek
<a href="#">libpng 1.6.16</a>	<a href="#">Libpng</a>	Copyright (c) 1998-2014 Glenn Randers-Pehrson (Version 0.96 Copyright (c) 1996, 1997 Andreas Dilger) (Version 0.88 Copyright (c) 1995, 1996 GUV

		(version 0.00 Copyright (c) 1999, 1998 by Eric Schalnat, Group 42, Inc.)
<a href="#">libtirpc 0.2.5</a>	<a href="#">BSD-3-Clause</a>	Copyright (c) Copyright (c) Bull S.A. 2005
<a href="#">libX11 1.6.2</a>	<a href="#">X11</a>	<p>Copyright (c) 2003-2006, 2008, Jamey Sharp, Josh Triplett</p> <p>Copyright (c) 2009, Red Hat, Inc.</p> <p>Copyright (c) 1990-1992, 1999-2000, 2004, 2009-2010, Oracle and/or its affiliates.</p> <p>Copyright (c) 1984-1994, 1998, The Open Group</p> <p>Copyright (c) 1985, 1986, 1987, 1988, 1989, 1990, 1991, 1994, 1996, X Consortium</p> <p>Copyright (c) 2000, The XFree86, Project, Inc.</p> <p>Copyright (c) 1999-2000, Free Software Foundation, Inc.</p> <p>Copyright (c) 1992, Oki Technosystems Laboratory, Inc.</p> <p>Copyright (c) 1990-1995, FUJITSU LIMITED</p> <p>Copyright (c) 1995, David E. Wexelblat. All rights reserved</p> <p>Copyright (c) 1990, 1991, OMRON Corporation</p> <p>Copyright (c) 1990, 1991, Tektronix, Inc</p> <p>Copyright (c) 1991, the Open Software Foundation</p> <p>Copyright (c) 1993, 1995, Silicon Graphics Computer Systems, Inc.</p> <p>Copyright (c) 1993, Fujitsu Open Systems Solutions, Inc.</p> <p>Copyright (c) 1987-1988, 1990, 1993, Digital Equipment Corporation</p> <p>Copyright (c) 1993, SunSoft, Inc.</p> <p>Copyright (c) 1999-2000, Bruno Haible</p> <p>Copyright (c) 1993, the TOSHIBA Corp.</p> <p>Copyright (c) 1993, 1994, Sony Corporation</p> <p>Copyright (c) 1990, 1991, OMRON Corporation, NTT Software Corporation,</p> <p>Copyright (c) 1988, Wyse Technology, Inc., San Jose, Ca,</p> <p>Copyright (c) 1991, 1992, Fuji Xerox Co., Ltd.</p> <p>Copyright (c) 1996, Sebastien Marineau and Helmut Veit</p>

		Hoiger veit Copyright (c) 2000, Bruno Haible Copyright (c) 2003, Keith Packard Copyright (c) 2007-2009, Troy D. Hanson Copyright (c) 1992, 1993, TOSHIBA Corp. Copyright (c) 1993, IBM Corporation
<a href="#">libXcursor 1.1.14</a>	<a href="#">MIT-like License (libXcursor)</a>	
<a href="#">libXft 2.3.2</a>	<a href="#">HPND</a>	Copyright (c) 2001,2003 Keith Packard
<a href="#">libxml2 2.9.2</a>	<a href="#">MIT</a>	Copyright (c) 1998-2012 Daniel Veillard.
<a href="#">libxml2</a>	<a href="#">MIT</a>	Copyright (C) 1998-2003 Daniel Veillard
<a href="#">libXmu 1.1.2</a>	<a href="#">MIT-like License (libXmu)</a>	
<a href="#">libXScrnSaver 1.2.2</a>	<a href="#">X11</a>	Copyright (c) 1992, X Consortium Copyright (c) 2003, The XFree86 Project, Inc.
<a href="#">libXxf86dga 1.1.4</a>	<a href="#">MIT-like License (font-xfree86-type1)</a>	Copyright (c) 1995 Jon Tombs Copyright (c) 1995, 1996 The XFree86 Project, Inc
<a href="#">list-to-tree 0.0.5</a>	<a href="#">BSD-3-Clause</a>	Copyright (c) 2013, Denis Ivanov
<a href="#">lodash 4.17.4</a>	<a href="#">MIT</a>	Copyright JS Foundation and other contributors < <a href="https://js.foundation/">https://js.foundation/</a> >
<a href="#">lodash 3.10.1</a>	<a href="#">MIT</a>	Copyright (c) 2012-2015 The Dojo Foundation < <a href="http://dojofoundation.org/">http://dojofoundation.org/</a> > Based on Underscore.js, copyright 2009-2015 Jeremy Ashkenas, DocumentCloud and Investigative Reporters & Editors < <a href="http://underscorejs.org/">http://underscorejs.org/</a> >
<a href="#">main-bower-files 2.13.1</a>	<a href="#">MIT</a>	Copyright (c) 2013 Christopher Knötschke
<a href="#">Mesa3D 10.4.4</a>	<a href="#">MIT</a>	Copyright (c) 1999-2003 Brian Paul

<a href="#">method-override 2.3.9</a>	<a href="#">MIT</a>	Copyright (c) 2014 Jonathan Ong <me@jongleberry.com> Copyright (c) 2014 Douglas Christopher Wilson <doug@somethingdoug.com>
<a href="#">minini 1.2</a>	<a href="#">Apache-2.0</a>	
<a href="#">minini</a>	<a href="#">Apache-2.0</a>	
<a href="#">moment 2.18.1</a>	<a href="#">MIT</a>	Copyright (c) JS Foundation and other contributors
<a href="#">moment 2.10.6</a>	<a href="#">MIT</a>	Copyright (c) 2011-2014 Tim Wood, Iskren Chernev, Moment.js contributors
<a href="#">morgan 1.8.2</a>	<a href="#">MIT</a>	Copyright (c) 2014 Jonathan Ong <me@jongleberry.com> Copyright (c) 2014-2015 Douglas Christopher Wilson <doug@somethingdoug.com>
<a href="#">mtdev 1.1.5</a>	<a href="#">MIT</a>	Copyright (C) 2010 Henrik Rydberg Copyright (C) 2010 Canonical Ltd.
<a href="#">my-bubble</a>	<a href="#">Apache-2.0</a>	Copyright (c) 2007, Uppsala University
<a href="#">ncurses 5.9</a>	<a href="#">MIT-like License (ncurses)</a>	Copyright (c) 1998-2004,2006 Free Software Foundation, Inc.
<a href="#">ndkit 0.0.3</a>	<a href="#">MIT</a>	Copyright (c) HOJUNG-AHN
<a href="#">ng-file-upload 12.2.13</a>	<a href="#">MIT</a>	Copyright (c) 2013 danialfarid
<a href="#">nginx 1.10.3</a>	<a href="#">BSD-2-Clause</a>	Copyright (C) 2002-2016 Igor Sysoev Copyright (C) 2011-2016 Nginx, Inc.
<a href="#">node-gyp 3.6.2</a>	<a href="#">MIT</a>	Copyright (c) 2012 Nathan Rajlich
<a href="#">node-mailer 2.7.2</a>	<a href="#">MIT</a>	Copyright (c) 2011-2016 Andris Reinman
<a href="#">node-mime 1.3.6</a>	<a href="#">MIT</a>	Copyright (c) 2010 Benjamin Thomas, Robert Kieffer
<a href="#">node-q 1.5.0</a>	<a href="#">MIT</a>	Copyright 2009–2017 Kristopher Michael

		Kowal.
<a href="#">node-sqlite3 3.1.8</a>	<a href="#">BSD-3-Clause</a>	Copyright (c) MapBox
<a href="#">node-unzip-2 0.2.5</a>	<a href="#">MIT</a>	Copyright (c) 2012 - 2013 Near Infinity Corporation
<a href="#">nodejs 4.2.4</a>	<a href="#">MIT</a>	Copyright (c) Joyent, Inc. and other Node contributors.
<a href="#">nodemailer-smtp-transport 2.7.4</a>	<a href="#">MIT</a>	Copyright (c) 2014-2016 Andris Reinman
<a href="#">npm 2.14.12</a>	<a href="#">Artistic-2.0</a>	Copyright (c) npm, Inc. and Contributors Copyright (c) 2000-2006, The Perl Foundation.
<a href="#">ntpdate 4.2.8</a>	<a href="#">NTP</a>	
<a href="#">OpenGL-ES</a>	<a href="#">Apache-2.0</a>	Copyright (c) 2013-2017 The Khronos Group Inc. Copyright (c) 2008-2017 The Khronos Group Inc.
<a href="#">openssl 1.0.2d</a>	<a href="#">OpenSSL</a>	
<a href="#">openssl</a>	<a href="#">OpenSSL</a>	Copyright (c) 1998-2017 The OpenSSL Project. Copyright (C) 1995-1998 Eric Young (eay@cryptsoft.com)
<a href="#">OpenVG</a>	<a href="#">MIT</a>	Copyright (c) 2008 The Khronos Group Inc.
<a href="#">passport 0.3.2</a>	<a href="#">MIT</a>	Copyright (c) 2011-2015 Jared Hanson
<a href="#">passport-local 1.0.0</a>	<a href="#">MIT</a>	Copyright (c) 2011-2015 Jared Hanson
<a href="#">path 0.12.7</a>	<a href="#">MIT</a>	Copyright Joyent, Inc. and other Node contributors
<a href="#">pcre 8.36</a>	<a href="#">BSD-3-Clause</a>	Copyright (c) University of Cambridge Computing Service, Cambridge, England. Copyright (c) 1997-2012 University of Cambridge Copyright (c) 2009-2012 Zoltan Herczeg

		Copyright (c) 2007-2012, Google Inc.
<a href="#">perl 5.20.0</a>	<a href="#">Artistic-1.0-Perl</a>	Copyright (C) 1993-2014 by Larry Wall and others.
<a href="#">Pixman 0.32.6</a>	<a href="#">MIT</a>	Copyright (c) 2012 Hannes Flicka
<a href="#">read-chunk 2.0.0</a>	<a href="#">MIT</a>	Copyright (c) Sindre Sorhus <sindresorhus@gmail.com> (sindresorhus.com)
<a href="#">rgb 1.0.6</a>	<a href="#">MIT</a>	Copyright (c) 1994, 2008, Oracle and/or its affiliates
<a href="#">rpcbind 0.2.2</a>	<a href="#">BSD-3-Clause</a>	Copyright (c) Bull S.A. 2005
<a href="#">serve-favicon 2.4.3</a>	<a href="#">MIT</a>	Copyright (c) 2010 Sencha Inc. Copyright (c) 2011 LearnBoost Copyright (c) 2011 TJ Holowaychuk Copyright (c) 2014-2017 Douglas Christopher Wilson
<a href="#">shadow 4.2.1</a>	<a href="#">BSD-3-Clause</a>	Copyright (c) 2007 - 2009, Nicolas François Copyright (c) 1989 - 1994, Julianne Frances Haugh Copyright (c) 1991 - 1993, Chip Rosenthal Copyright (c) 1996 - 2000, Marek Michalkiewicz Copyright (c) 2003 - 2005, Tomasz Kloczko
<a href="#">shelljs 0.6.1</a>	<a href="#">BSD-3-Clause</a>	Copyright (c) 2012, Artur Adib <aadib@mozilla.com>
<a href="#">sudo 1.8.11p2</a>	<a href="#">MIT-like License (sudo)</a>	
<a href="#">tiff 4.0.3</a>	<a href="#">libtiff</a>	Copyright (c) 1988-1997 Sam Leffler Copyright (c) 1991-1997 Silicon Graphics, Inc.
<a href="#">x2js 1.2.0</a>	<a href="#">Apache-2.0</a>	Copyright (c) 2011-2013 Abdulla Abdurakhmanov
<a href="#">yauth 1.0.0</a>	<a href="#">The Open</a>	Copyright (c) 1985, 1988, 1998 , The Open

<a href="#">XCB 1.0.2</a>	<a href="#">Group License</a>	Group
<a href="#">XCB 1.11</a>	<a href="#">MIT</a>	Copyright (C) 2001-2006 Bart Massey, Jamey Sharp, and Josh Triplett.
<a href="#">xcb-util 0.4.0</a>	<a href="#">MIT-like License (xcb-util)</a>	Copyright (c) 2008 Bart Massey Copyright (c) 2008 Ian Osgood Copyright (c) 2008 Jamey Sharp Copyright (c) 2008 Josh Triplett Copyright (c) 2008-2009 Julien Danjou
<a href="#">xdpyinfo 1.3.1</a>	<a href="#">The Open Group License</a>	Copyright (c) 1988, 1998, The Open Group Copyright (c) 2005, Hitachi, Ltd.
<a href="#">xf86-input-evdev 2.9.1</a>	<a href="#">HPND MIT</a>	Copyright (c) 1990-1991, Thomas Roell, Dinkelscherben, Germany. Copyright (c) 1993, David Dawes <dawes@xfree86.org> Copyright (c) 2002, SuSE Linux AG, Author: Egbert Eich Copyright (c) 1994-2002, The XFree86 Project, Inc. Copyright (c) 2002, Paul Elliott Copyright (c) 2008, University of South Australia Copyright (c) 2008, Chris Salch Copyright (c) 2008, Red Hat, Inc. Copyright (c) 2005, Sun Microsystems, Inc. Copyright (c) 2005, Adam Jackson.
<a href="#">xhost 1.0.6</a>	<a href="#">MIT</a>	Copyright (c) 2004, Oracle and/or its affiliates.
<a href="#">xinit 1.3.4</a>	<a href="#">The Open Group License</a>	Copyright (c) 1986, 1988, 1993, 1998 , The Open Group
<a href="#">xinput 1.6.1</a>	<a href="#">MIT</a>	Copyright (c) 2007, Peter Hutterer Copyright (c) 2009, Red Hat, Inc.
<a href="#">xinput calibrator 0.7.5</a>	<a href="#">MIT</a>	Copyright (c) 2010 Tias Guns <tias@ulyssis.org> and others
<a href="#">xkbcomp 1.3.0</a>	<a href="#">MIT-like License (xkbcomp)</a>	

<a href="#">xml2js 0.4.17</a>	<a href="#">MIT</a>	
<a href="#">xmldom 0.1.27</a>	<a href="#">MIT</a>	
<a href="#">xmodmap 1.0.8</a>	<a href="#">MIT</a>	Copyright (c) 1987, 2010, Oracle and/or its affiliates
<a href="#">xorg-lib-libpciaccess 0.13.3</a>	<a href="#">ISC</a> <a href="#">MIT</a> <a href="#">X11</a>	Copyright (c) 2008 Juan Romero Pardines Copyright (c) 2008, 2011 Mark Kettenis Copyright (c) 2009 Michael Lorenz Copyright (c) 2009, 2012 Samuel Thibault Copyright (c) IBM Corporation 2006, 2007 Copyright (c) Eric Anholt 2006 Copyright (c) Mark Kettenis 2011 Copyright (c) Robert Millan 2012 Copyright (c) 2007, 2008, 2009, 2011, 2012, 2013 Oracle and/or its affiliates. Copyright (c) 2009, 2012 Red Hat, Inc. Copyright (c) 2007 Paulo R. Zanoni, Tiago Vignatti Copyright (c) 2009 Tiago Vignatti Copyright (c) 2000 The XFree86 Project, Inc.
<a href="#">xorg-lib-libXau 1.0.8</a>	<a href="#">The Open Group License</a>	Copyright 1988, 1993, 1994, 1998 The Open Group
<a href="#">xorg-lib-libXcomposite 0.4.4</a>	<a href="#">MIT</a>	Copyright (c) 2006, 2007, Oracle and/or its affiliates.
<a href="#">xorg-lib-libXdamage 1.1.4</a>	<a href="#">HPND</a>	Copyright (c) 2001,2003 Keith Packard Copyright (c) 2007 Eric Anholt
<a href="#">xorg-lib-libXdmcpc 1.1.1</a>	<a href="#">The Open Group License</a>	Copyright (c) 1989, 1998 , The Open Group
<a href="#">xorg-lib-libXext 1.3.3</a>	<a href="#">The Open Group License</a>	Copyright (c) 1986, 1987, 1988, 1989, 1994, 1998 The Open Group
<a href="#">xorg-lib-libXfixes 5.0.1</a>	<a href="#">HPND</a> <a href="#">MIT</a>	Copyright (c) 2001,2003, Keith Packard Copyright (c) 2006, Oracle and/or its affiliates.
		Copyright (c) 1998-1999 Shunsuke Akiyama sakiyama@in.frodoed.org

<p><a href="#">xorg-lib-libXfont 1.5.0</a></p>	<p><a href="#">BSD-2-Clause</a>  <a href="#">BSD-3-Clause</a>  <a href="#">MIT</a>  <a href="#">The Open Group License</a></p>	<p>~akiyama@jp.freebsd.org.  Copyright (c) 1998-1999 X-TrueType Server Project,  Copyright (c) 1991, 1993 The Regents of the University of California.  Copyright (c) 2007 Red Hat, Inc  Copyright (c) 2008, 2009, Oracle and/or its affiliates  Copyright (c) 1997 by Mark Leisher  Copyright (c) 1998-2003 by Juliusz Chroboczek  Copyright (c) 1998 Go Watanabe  Copyright (c) 1998 Kazushi (Jam) Marukawa  Copyright (c) 1998 Takuya SHIOZAKI  Copyright (c) 1998 X-TrueType Server Project  Copyright (c) 2003-2004 After X-TT Project    Copyright (c) 1990, 1998 The Open Group</p>
<p><a href="#">xorg-lib-libXi 1.7.4</a></p>	<p><a href="#">HPND</a></p>	<p>Copyright (c) 1989, Hewlett-Packard Company, Palo Alto, California.</p>
<p><a href="#">xorg-lib-libXinerama 1.1.3</a></p>	<p><a href="#">MIT</a>  <a href="#">The Open Group License</a>  <a href="#">X11</a></p>	<p>Copyright (c) 2007, Oracle and/or its affiliates.  Copyright (c) 2003, The Open Group  Copyright (c) 1991, 1997, Digital Equipment Corporation, Maynard, Massachusetts.</p>
<p><a href="#">xorg-lib-libxkbfile 1.0.8</a></p>	<p><a href="#">HPND</a>  <a href="#">The Open Group License</a></p>	<p>Copyright (c) 1994-1996, Silicon Graphics Computer Systems, Inc.  Copyright (c) 1987, Digital Equipment Corporation, Maynard, Massachusetts.    Copyright (c) 1987, 1998, The Open Group</p>
<p><a href="#">xorg-lib-libXrender 0.9.8</a></p>	<p><a href="#">HPND</a></p>	<p>Copyright (c) 2001,2003 Keith Packard  Copyright (c) 2000 SuSE, Inc.</p>
	<p><a href="#">HPND</a>  <a href="#">The Open</a></p>	<p>Copyright (c) 1995, Network Computing Devices  Copyright (c) 2005, Red Hat, Inc.  Copyright (c) 1992, UniSoft Group Ltd.  Copyright (c) 1994, Network Computing Devices, Inc.</p>

<a href="#">xorg-lib-libXtst 1.2.2</a>	<a href="#">The Open Group License X11</a>	Devices, Inc. Copyright (c) 1992, 1993, 1995, 1998, The Open Group Copyright (c) 1990, 1991, UniSoft Group Limited Copyright (c) 1992, 1994, 1995, X Consortium
<a href="#">xorg-lib-libXxf86misc 1.0.3</a>	<a href="#">X11</a>	Copyright (c) 1995, 1996, The XFree86 Project, Inc
<a href="#">xorg-lib-libXxf86vm 1.1.3</a>	<a href="#">X11</a>	Copyright (c) 1995 Kaleb S. KEITHLEY
<a href="#">xrandr 1.4.3</a>	<a href="#">HPND</a>	Copyright (c) 2001 Keith Packard, member of The XFree86 Project, Inc. Copyright (c) 2002 Hewlett Packard Company, Inc. Copyright (c) 2006 Intel Corporation
<a href="#">xrandr 1.4.2</a>	<a href="#">HPND</a>	Copyright (c) 2001 Keith Packard, member of The XFree86 Project, Inc. Copyright (c) 2002 Hewlett Packard Company, Inc. Copyright (c) 2006 Intel Corporation
<a href="#">xserver 1.17.2</a>	<a href="#">MIT-like License (xserver)</a>	
<a href="#">xset 1.2.3</a>	<a href="#">The Open Group License</a>	Copyright (c) 1985, 1988, 1998, The Open Group
<a href="#">Xsettings-client 0.10</a>	<a href="#">MIT</a>	Copyright (c) 2001, Red Hat, Inc.
<a href="#">zlib 1.2.8</a>	<a href="#">Zlib</a>	Copyright (c) 1995-2013 Jean-loup Gailly and Mark Adler

This software is based in part on the work of the Independent JPEG Group

This product includes software developed by the OpenSSL Project for use in the OpenSSL Toolkit (<http://www.openssl.org/>)

## AFL-2.0

The Academic Free License  
v. 2.0

This Academic Free License (the "License") applies to any original work of authorship (the "Original Work") whose owner (the "Licensor") has placed the following notice immediately following the copyright notice for the Original Work:

Licensed under the Academic Free License version 2.0

1) Grant of Copyright License. Licensor hereby grants You a world-wide, royalty-free, non-exclusive, perpetual, sublicenseable license to do the following:

- a) to reproduce the Original Work in copies;
- b) to prepare derivative works ("Derivative Works") based upon the Original Work;
- c) to distribute copies of the Original Work and Derivative Works to the public;
- d) to perform the Original Work publicly; and
- e) to display the Original Work publicly.

2) Grant of Patent License. Licensor hereby grants You a world-wide, royalty-free, non-exclusive, perpetual, sublicenseable license, under patent claims owned or controlled by the Licensor that are embodied in the Original Work as furnished by the Licensor, to make, use, sell and offer for sale the Original Work and Derivative Works.

3) Grant of Source Code License. The term "Source Code" means the preferred form of the Original Work for making modifications to it and all available documentation describing how to modify the Original Work. Licensor hereby agrees to provide a machine-readable copy of the Source Code of the Original Work along with each copy of the Original Work that Licensor distributes. Licensor reserves the right to satisfy this obligation by placing a machine-readable copy of the Source Code in an information repository reasonably calculated to permit inexpensive and convenient access by You for as long as Licensor continues to distribute the Original Work, and by publishing the address of that information repository in a notice immediately following the copyright notice that applies to the Original Work.

4) Exclusions From License Grant. Neither the names of Licensor, nor the names of any contributors to the Original Work, nor any of their trademarks or service marks, may be used to endorse or promote products derived from this Original Work without express prior written permission of the Licensor. Nothing in this License shall be deemed to grant any rights to trademarks, copyrights, patents, trade secrets or any other intellectual property of

Licensors except as expressly stated herein. No patent license is granted to make, use, sell or offer to sell embodiments of any patent claims other than the licensed claims defined in Section 2. No right is granted to the trademarks of Licensor even if such marks are included in the Original Work. Nothing in this License shall be interpreted to prohibit Licensor from licensing under different terms from this License any Original Work that Licensor otherwise would have a right to license.

5) This section intentionally omitted.

6) Attribution Rights. You must retain, in the Source Code of any Derivative Works that You create, all copyright, patent or trademark notices from the Source Code of the Original Work, as well as any notices of licensing and any descriptive text identified therein as an "Attribution Notice." You must cause the Source Code for any Derivative Works that You create to carry a prominent Attribution Notice reasonably calculated to inform recipients that You have modified the Original Work.

7) Warranty of Provenance and Disclaimer of Warranty. Licensor warrants that the copyright in and to the Original Work and the patent rights granted herein by Licensor are owned by the Licensor or are sublicensed to You under the terms of this License with the permission of the contributor(s) of those copyrights and patent rights. Except as expressly stated in the immediately preceding sentence, the Original Work is provided under this License on an "AS IS" BASIS and WITHOUT WARRANTY, either express or implied, including, without limitation, the warranties of NON-INFRINGEMENT, MERCHANTABILITY or FITNESS FOR A PARTICULAR PURPOSE. THE ENTIRE RISK AS TO THE QUALITY OF THE ORIGINAL WORK IS WITH YOU. This DISCLAIMER OF WARRANTY constitutes an essential part of this License. No license to Original Work is granted hereunder except under this disclaimer.

8) Limitation of Liability. Under no circumstances and under no legal theory, whether in tort (including negligence), contract, or otherwise, shall the Licensor be liable to any person for any direct, indirect, special, incidental, or consequential damages of any character arising as a result of this License or the use of the Original Work including, without limitation, damages for loss of goodwill, work stoppage, computer failure or malfunction, or any and all other commercial damages or losses. This limitation of liability shall not apply to liability for death or personal injury resulting from Licensor's negligence to the extent applicable law prohibits such limitation. Some jurisdictions do not allow the exclusion or limitation of incidental or consequential damages, so this exclusion and limitation may not apply to You.

9) Acceptance and Termination. If You distribute copies of the Original Work or a Derivative Work, You must make a reasonable effort under the circumstances to obtain the express assent of recipients to the terms of this License. Nothing else but this License (or another written agreement between Licensor and You) grants You permission to create Derivative Works based upon the Original Work or to exercise any of the rights granted in Section 1 herein, and any attempt to do so except under the terms of this License (or another written

agreement between Licensor and You) is expressly prohibited by U.S. copyright law, the equivalent laws of other countries, and by international treaty. Therefore, by exercising any of the rights granted to You in Section 1 herein, You indicate Your acceptance of this License and all of its terms and conditions.

10) Termination for Patent Action. This License shall terminate automatically and You may no longer exercise any of the rights granted to You by this License as of the date You commence an action, including a cross-claim or counterclaim, for patent infringement (i) against Licensor with respect to a patent applicable to software or (ii) against any entity with respect to a patent applicable to the Original Work (but excluding combinations of the Original Work with other software or hardware).

11) Jurisdiction, Venue and Governing Law. Any action or suit relating to this License may be brought only in the courts of a jurisdiction wherein the Licensor resides or in which Licensor conducts its primary business, and under the laws of that jurisdiction excluding its conflict-of-law provisions. The application of the United Nations Convention on Contracts for the International Sale of Goods is expressly excluded. Any use of the Original Work outside the scope of this License or after its termination shall be subject to the requirements and penalties of the U.S. Copyright Act, 17 U.S.C.  $\text{\textasciitilde}$  101 et seq., the equivalent laws of other countries, and international treaty. This section shall survive the termination of this License.

12) Attorneys Fees. In any action to enforce the terms of this License or seeking damages relating thereto, the prevailing party shall be entitled to recover its costs and expenses, including, without limitation, reasonable attorneys' fees and costs incurred in connection with such action, including any appeal of such action. This section shall survive the termination of this License.

13) Miscellaneous. This License represents the complete agreement concerning the subject matter hereof. If any provision of this License is held to be unenforceable, such provision shall be reformed only to the extent necessary to make it enforceable.

14) Definition of "You" in This License. "You" throughout this License, whether in upper or lower case, means an individual or a legal entity exercising rights under, and complying with all of the terms of, this License. For legal entities, "You" includes any entity that controls, is controlled by, or is under common control with you. For purposes of this definition, "control" means (i) the power, direct or indirect, to cause the direction or management of such entity, whether by contract or otherwise, or (ii) ownership of fifty percent (50%) or more of the outstanding shares, or (iii) beneficial ownership of such entity.

15) Right to Use. You may use the Original Work in all ways not otherwise restricted or conditioned by this License or by law, and Licensor promises not to interfere with or be responsible for such uses by You

responsible for such uses by You.

This license is Copyright (C) 2003 Lawrence E. Rosen. All rights reserved.

Permission is hereby granted to copy and distribute this license without modification. This license may not be modified without the express written permission of its copyright owner.

---

## **AFL-2.1**

The Academic Free License

v.2.1

This Academic Free License (the "License") applies to any original work of authorship (the "Original Work") whose owner (the "Licensor") has placed the following notice immediately following the copyright notice for the Original Work:

Licensed under the Academic Free License version 2.1

1) Grant of Copyright License. Licensor hereby grants You a world-wide, royalty-free, non-exclusive, perpetual, sublicenseable license to do the following:

- a) to reproduce the Original Work in copies;
- b) to prepare derivative works ("Derivative Works") based upon the Original Work;
- c) to distribute copies of the Original Work and Derivative Works to the public;
- d) to perform the Original Work publicly; and
- e) to display the Original Work publicly.

2) Grant of Patent License. Licensor hereby grants You a world-wide, royalty-free, non-exclusive, perpetual, sublicenseable license, under patent claims owned or controlled by the Licensor that are embodied in the Original Work as furnished by the Licensor, to make, use, sell and offer for sale the Original Work and Derivative Works.

3) Grant of Source Code License. The term "Source Code" means the preferred form of the Original Work for making modifications to it and all available documentation describing how to modify the Original Work. Licensor hereby agrees to provide a machine-readable copy of the Source Code of the Original Work along with each copy of the Original Work that Licensor distributes. Licensor reserves the right to satisfy this obligation by placing a machine-readable copy of the Source Code in an information repository reasonably calculated to permit inexpensive and convenient access by You for as long as Licensor continues to distribute the Original Work, and by publishing the address of that information repository in a notice immediately following the copyright notice that applies

to the Original Work.

4) Exclusions From License Grant. Neither the names of Licensor, nor the names of any contributors to the Original Work, nor any of their trademarks or service marks, may be used to endorse or promote products derived from this Original Work without express prior written permission of the Licensor. Nothing in this License shall be deemed to grant any rights to trademarks, copyrights, patents, trade secrets or any other intellectual property of Licensor except as expressly stated herein. No patent license is granted to make, use, sell or offer to sell embodiments of any patent claims other than the licensed claims defined in Section 2. No right is granted to the trademarks of Licensor even if such marks are included in the Original Work. Nothing in this License shall be interpreted to prohibit Licensor from licensing under different terms from this License any Original Work that Licensor otherwise would have a right to license.

5) This section intentionally omitted.

6) Attribution Rights. You must retain, in the Source Code of any Derivative Works that You create, all copyright, patent or trademark notices from the Source Code of the Original Work, as well as any notices of licensing and any descriptive text identified therein as an "Attribution Notice." You must cause the Source Code for any Derivative Works that You create to carry a prominent Attribution Notice reasonably calculated to inform recipients that You have modified the Original Work.

7) Warranty of Provenance and Disclaimer of Warranty. Licensor warrants that the copyright in and to the Original Work and the patent rights granted herein by Licensor are owned by the Licensor or are sublicensed to You under the terms of this License with the permission of the contributor(s) of those copyrights and patent rights. Except as expressly stated in the immediately preceding sentence, the Original Work is provided under this License on an "AS IS" BASIS and WITHOUT WARRANTY, either express or implied, including, without limitation, the warranties of NON-INFRINGEMENT, MERCHANTABILITY or FITNESS FOR A PARTICULAR PURPOSE. THE ENTIRE RISK AS TO THE QUALITY OF THE ORIGINAL WORK IS WITH YOU. This DISCLAIMER OF WARRANTY constitutes an essential part of this License. No license to Original Work is granted hereunder except under this disclaimer.

8) Limitation of Liability. Under no circumstances and under no legal theory, whether in tort (including negligence), contract, or otherwise, shall the Licensor be liable to any person for any direct, indirect, special, incidental, or consequential damages of any character arising as a result of this License or the use of the Original Work including, without limitation, damages for loss of goodwill, work stoppage, computer failure or malfunction, or any and all other commercial damages or losses. This limitation of liability shall not apply to liability for death or personal injury resulting from Licensor's negligence to the extent applicable law prohibits such limitation. Some jurisdictions do not allow the exclusion or limitation of incidental or consequential damages, so this exclusion and limitation may not apply to You.

9) Acceptance and Termination. If You distribute copies of the Original Work or a Derivative Work, You must make a reasonable effort under the circumstances to obtain the express assent of recipients to the terms of this License. Nothing else but this License (or another written agreement between Licensor and You) grants You permission to create Derivative Works based upon the Original Work or to exercise any of the rights granted in Section 1 herein, and any attempt to do so except under the terms of this License (or another written agreement between Licensor and You) is expressly prohibited by U.S. copyright law, the equivalent laws of other countries, and by international treaty. Therefore, by exercising any of the rights granted to You in Section 1 herein, You indicate Your acceptance of this License and all of its terms and conditions.

10) Termination for Patent Action. This License shall terminate automatically and You may no longer exercise any of the rights granted to You by this License as of the date You commence an action, including a cross-claim or counterclaim, against Licensor or any licensee alleging that the Original Work infringes a patent. This termination provision shall not apply for an action alleging patent infringement by combinations of the Original Work with other software or hardware.

11) Jurisdiction, Venue and Governing Law. Any action or suit relating to this License may be brought only in the courts of a jurisdiction wherein the Licensor resides or in which Licensor conducts its primary business, and under the laws of that jurisdiction excluding its conflict-of-law provisions. The application of the United Nations Convention on Contracts for the International Sale of Goods is expressly excluded. Any use of the Original Work outside the scope of this License or after its termination shall be subject to the requirements and penalties of the U.S. Copyright Act, 17 U.S.C. § 101 et seq., the equivalent laws of other countries, and international treaty. This section shall survive the termination of this License.

12) Attorneys Fees. In any action to enforce the terms of this License or seeking damages relating thereto, the prevailing party shall be entitled to recover its costs and expenses, including, without limitation, reasonable attorneys' fees and costs incurred in connection with such action, including any appeal of such action. This section shall survive the termination of this License.

13) Miscellaneous. This License represents the complete agreement concerning the subject matter hereof. If any provision of this License is held to be unenforceable, such provision shall be reformed only to the extent necessary to make it enforceable.

14) Definition of "You" in This License. "You" throughout this License, whether in upper or lower case, means an individual or a legal entity exercising rights under, and complying with all of the terms of, this License. For legal entities, "You" includes any entity that controls, is controlled by, or is under common control with you. For purposes of this definition, "control" means (i) the power, direct or indirect, to cause the direction or

definition, "control" means (i) the power, direct or indirect, to cause the direction or management of such entity, whether by contract or otherwise, or (ii) ownership of fifty percent (50%) or more of the outstanding shares, or (iii) beneficial ownership of such entity.

15) Right to Use. You may use the Original Work in all ways not otherwise restricted or conditioned by this License or by law, and Licensor promises not to interfere with or be responsible for such uses by You.

This license is Copyright (C) 2003-2004 Lawrence E. Rosen. All rights reserved.  
Permission is hereby granted to copy and distribute this license without modification. This license may not be modified without the express written permission of its copyright owner.

---

## Apache-2.0

Apache License  
Version 2.0, January 2004  
<http://www.apache.org/licenses/>

### TERMS AND CONDITIONS FOR USE, REPRODUCTION, AND DISTRIBUTION

#### 1. Definitions.

"License" shall mean the terms and conditions for use, reproduction, and distribution as defined by Sections 1 through 9 of this document.

"Licensor" shall mean the copyright owner or entity authorized by the copyright owner that is granting the License.

"Legal Entity" shall mean the union of the acting entity and all other entities that control, are controlled by, or are under common control with that entity. For the purposes of this definition, "control" means (i) the power, direct or indirect, to cause the direction or management of such entity, whether by contract or otherwise, or (ii) ownership of fifty percent (50%) or more of the outstanding shares, or (iii) beneficial ownership of such entity.

"You" (or "Your") shall mean an individual or Legal Entity exercising permissions granted by this License.

"Source" form shall mean the preferred form for making modifications, including but not

limited to software source code, documentation source, and configuration files.

"Object" form shall mean any form resulting from mechanical transformation or translation of a Source form, including but not limited to compiled object code, generated documentation, and conversions to other media types.

"Work" shall mean the work of authorship, whether in Source or Object form, made available under the License, as indicated by a copyright notice that is included in or attached to the work (an example is provided in the Appendix below).

"Derivative Works" shall mean any work, whether in Source or Object form, that is based on (or derived from) the Work and for which the editorial revisions, annotations, elaborations, or other modifications represent, as a whole, an original work of authorship. For the purposes of this License, Derivative Works shall not include works that remain separable from, or merely link (or bind by name) to the interfaces of, the Work and Derivative Works thereof.

"Contribution" shall mean any work of authorship, including the original version of the Work and any modifications or additions to that Work or Derivative Works thereof, that is intentionally submitted to Licensor for inclusion in the Work by the copyright owner or by an individual or Legal Entity authorized to submit on behalf of the copyright owner. For the purposes of this definition, "submitted" means any form of electronic, verbal, or written communication sent to the Licensor or its representatives, including but not limited to communication on electronic mailing lists, source code control systems, and issue tracking systems that are managed by, or on behalf of, the Licensor for the purpose of discussing and improving the Work, but excluding communication that is conspicuously marked or otherwise designated in writing by the copyright owner as "Not a Contribution."

"Contributor" shall mean Licensor and any individual or Legal Entity on behalf of whom a Contribution has been received by Licensor and subsequently incorporated within the Work.

2. Grant of Copyright License. Subject to the terms and conditions of this License, each Contributor hereby grants to You a perpetual, worldwide, non-exclusive, no-charge, royalty-free, irrevocable copyright license to reproduce, prepare Derivative Works of, publicly display, publicly perform, sublicense, and distribute the Work and such Derivative Works in Source or Object form.

3. Grant of Patent License. Subject to the terms and conditions of this License, each Contributor hereby grants to You a perpetual, worldwide, non-exclusive, no-charge, royalty-free, irrevocable (except as stated in this section) patent license to make, have made, use, offer to sell, sell, import, and otherwise transfer the Work, where such license applies only to those patent claims licensable by such Contributor that are necessarily infringed by their Contribution(s) alone or by combination of their Contribution(s) with the

infringed by their Contribution(s) alone or by combination of their Contribution(s) with the Work to which such Contribution(s) was submitted. If You institute patent litigation against any entity (including a cross-claim or counterclaim in a lawsuit) alleging that the Work or a Contribution incorporated within the Work constitutes direct or contributory patent infringement, then any patent licenses granted to You under this License for that Work shall terminate as of the date such litigation is filed.

4. Redistribution. You may reproduce and distribute copies of the Work or Derivative Works thereof in any medium, with or without modifications, and in Source or Object form, provided that You meet the following conditions:

(a) You must give any other recipients of the Work or Derivative Works a copy of this License; and

(b) You must cause any modified files to carry prominent notices stating that You changed the files; and

(c) You must retain, in the Source form of any Derivative Works that You distribute, all copyright, patent, trademark, and attribution notices from the Source form of the Work, excluding those notices that do not pertain to any part of the Derivative Works; and

(d) If the Work includes a "NOTICE" text file as part of its distribution, then any Derivative Works that You distribute must include a readable copy of the attribution notices contained within such NOTICE file, excluding those notices that do not pertain to any part of the Derivative Works, in at least one of the following places: within a NOTICE text file distributed as part of the Derivative Works; within the Source form or documentation, if provided along with the Derivative Works; or, within a display generated by the Derivative Works, if and wherever such third-party notices normally appear. The contents of the NOTICE file are for informational purposes only and do not modify the License. You may add Your own attribution notices within Derivative Works that You distribute, alongside or as an addendum to the NOTICE text from the Work, provided that such additional attribution notices cannot be construed as modifying the License.

You may add Your own copyright statement to Your modifications and may provide additional or different license terms and conditions for use, reproduction, or distribution of Your modifications, or for any such Derivative Works as a whole, provided Your use, reproduction, and distribution of the Work otherwise complies with the conditions stated in this License.

5. Submission of Contributions. Unless You explicitly state otherwise, any Contribution intentionally submitted for inclusion in the Work by You to the Licensor shall be under the terms and conditions of this License, without any additional terms or conditions. Notwithstanding the above, nothing herein shall supersede or modify the terms of any separate license agreement you may have executed with Licensor regarding such

Contributions.

6. Trademarks. This License does not grant permission to use the trade names, trademarks, service marks, or product names of the Licensor, except as required for reasonable and customary use in describing the origin of the Work and reproducing the content of the NOTICE file.

7. Disclaimer of Warranty. Unless required by applicable law or agreed to in writing, Licensor provides the Work (and each Contributor provides its Contributions) on an "AS IS" BASIS, WITHOUT WARRANTIES OR CONDITIONS OF ANY KIND, either express or implied, including, without limitation, any warranties or conditions of TITLE, NON-INFRINGEMENT, MERCHANTABILITY, or FITNESS FOR A PARTICULAR PURPOSE. You are solely responsible for determining the appropriateness of using or redistributing the Work and assume any risks associated with Your exercise of permissions under this License.

8. Limitation of Liability. In no event and under no legal theory, whether in tort (including negligence), contract, or otherwise, unless required by applicable law (such as deliberate and grossly negligent acts) or agreed to in writing, shall any Contributor be liable to You for damages, including any direct, indirect, special, incidental, or consequential damages of any character arising as a result of this License or out of the use or inability to use the Work (including but not limited to damages for loss of goodwill, work stoppage, computer failure or malfunction, or any and all other commercial damages or losses), even if such Contributor has been advised of the possibility of such damages.

9. Accepting Warranty or Additional Liability. While redistributing the Work or Derivative Works thereof, You may choose to offer, and charge a fee for, acceptance of support, warranty, indemnity, or other liability obligations and/or rights consistent with this License. However, in accepting such obligations, You may act only on Your own behalf and on Your sole responsibility, not on behalf of any other Contributor, and only if You agree to indemnify, defend, and hold each Contributor harmless for any liability incurred by, or claims asserted against, such Contributor by reason of your accepting any such warranty or additional liability.

END OF TERMS AND CONDITIONS

APPENDIX: How to apply the Apache License to your work.

To apply the Apache License to your work, attach the following boilerplate notice, with the fields enclosed by brackets "[]" replaced with your own identifying information. (Don't include the brackets!) The text should be enclosed in the appropriate comment syntax for the file format. We also recommend that a file or class name and description of purpose be included on the same "printed page" as the copyright notice for easier identification within third-party archives.

Copyright [yyyy] [name of copyright owner]

Licensed under the Apache License, Version 2.0 (the "License");  
you may not use this file except in compliance with the License.  
You may obtain a copy of the License at

<http://www.apache.org/licenses/LICENSE-2.0>

Unless required by applicable law or agreed to in writing, software  
distributed under the License is distributed on an "AS IS" BASIS,  
WITHOUT WARRANTIES OR CONDITIONS OF ANY KIND, either express or implied.  
See the License for the specific language governing permissions and  
limitations under the License.

---

## **Artistic-1.0-Perl**

The "Artistic License"

Preamble

The intent of this document is to state the conditions under which a Package may be copied, such that the Copyright Holder maintains some semblance of artistic control over the development of the package, while giving the users of the package the right to use and distribute the Package in a more-or-less customary fashion, plus the right to make reasonable modifications.

Definitions:

"Package" refers to the collection of files distributed by the Copyright Holder, and derivatives of that collection of files created through textual modification.

"Standard Version" refers to such a Package if it has not been modified, or has been modified in accordance with the wishes of the Copyright Holder as specified below.

"Copyright Holder" is whoever is named in the copyright or copyrights for the package.

"You" is you, if you're thinking about copying or distributing this Package.

"Reasonable copying fee" is whatever you can justify on the basis of media cost,

duplication charges, time of people involved, and so on. (You will not be required to justify it to the Copyright Holder, but only to the computing community at large as a market that must bear the fee.)

"Freely Available" means that no fee is charged for the item itself, though there may be fees involved in handling the item. It also means that recipients of the item may redistribute it under the same conditions they received it.

1. You may make and give away verbatim copies of the source form of the Standard Version of this Package without restriction, provided that you duplicate all of the original copyright notices and associated disclaimers.

2. You may apply bug fixes, portability fixes and other modifications derived from the Public Domain or from the Copyright Holder. A Package modified in such a way shall still be considered the Standard Version.

3. You may otherwise modify your copy of this Package in any way, provided that you insert a prominent notice in each changed file stating how and when you changed that file, and provided that you do at least ONE of the following:

a) place your modifications in the Public Domain or otherwise make them Freely Available, such as by posting said modifications to Usenet or an equivalent medium, or placing the modifications on a major archive site such as uunet.uu.net, or by allowing the Copyright Holder to include your modifications in the Standard Version of the Package.

b) use the modified Package only within your corporation or organization.

c) rename any non-standard executables so the names do not conflict with standard executables, which must also be provided, and provide a separate manual page for each non-standard executable that clearly documents how it differs from the Standard Version.

d) make other distribution arrangements with the Copyright Holder.

4. You may distribute the programs of this Package in object code or executable form, provided that you do at least ONE of the following:

a) distribute a Standard Version of the executables and library files, together with instructions (in the manual page or equivalent) on where to get the Standard Version.

b) accompany the distribution with the machine-readable source of the Package with your modifications.

c) give non-standard executables non-standard names, and clearly document the differences in manual pages (or equivalent), together with instructions on where to get the Standard Version.

d) make other distribution arrangements with the Copyright Holder.

5. You may charge a reasonable copying fee for any distribution of this Package. You may charge any fee you choose for support of this Package. You may not charge a fee for this

Package itself. However, you may distribute this Package in aggregate with other (possibly commercial) programs as part of a larger (possibly commercial) software distribution provided that you do not advertise this Package as a product of your own. You may embed this Package's interpreter within an executable of yours (by linking); this shall be construed as a mere form of aggregation, provided that the complete Standard Version of the interpreter is so embedded.

6. The scripts and library files supplied as input to or produced as output from the programs of this Package do not automatically fall under the copyright of this Package, but belong to whoever generated them, and may be sold commercially, and may be aggregated with this Package. If such scripts or library files are aggregated with this Package via the so-called "undump" or "unexec" methods of producing a binary executable image, then distribution of such an image shall neither be construed as a distribution of this Package nor shall it fall under the restrictions of Paragraphs 3 and 4, provided that you do not represent such an executable image as a Standard Version of this Package.

7. C subroutines (or comparably compiled subroutines in other languages) supplied by you and linked into this Package in order to emulate subroutines and variables of the language defined by this Package shall not be considered part of this Package, but are the equivalent of input as in Paragraph 6, provided these subroutines do not change the language in any way that would cause it to fail the regression tests for the language.

8. Aggregation of this Package with a commercial distribution is always permitted provided that the use of this Package is embedded; that is, when no overt attempt is made to make this Package's interfaces visible to the end user of the commercial distribution. Such use shall not be construed as a distribution of this Package.

9. The name of the Copyright Holder may not be used to endorse or promote products derived from this software without specific prior written permission.

10. THIS PACKAGE IS PROVIDED "AS IS" AND WITHOUT ANY EXPRESS OR IMPLIED WARRANTIES, INCLUDING, WITHOUT LIMITATION, THE IMPLIED WARRANTIES OF MERCHANTABILITY AND FITNESS FOR A PARTICULAR PURPOSE.

The End

---

## **Artistic-2.0**

Copyright (c) 2000-2006, The Perl Foundation.

Everyone is permitted to copy and distribute verbatim copies of this license document, but changing it is not allowed.

## Preamble

This license establishes the terms under which a given free software Package may be copied, modified, distributed, and/or redistributed. The intent is that the Copyright Holder maintains some artistic control over the development of that Package while still keeping the Package available as open source and free software.

You are always permitted to make arrangements wholly outside of this license directly with the Copyright Holder of a given Package. If the terms of this license do not permit the full use that you propose to make of the Package, you should contact the Copyright Holder and seek a different licensing arrangement.

## Definitions

"Copyright Holder" means the individual(s) or organization(s) named in the copyright notice for the entire Package.

"Contributor" means any party that has contributed code or other material to the Package, in accordance with the Copyright Holder's procedures.

"You" and "your" means any person who would like to copy, distribute, or modify the Package.

"Package" means the collection of files distributed by the Copyright Holder, and derivatives of that collection and/or of those files. A given Package may consist of either the Standard Version, or a Modified Version.

"Distribute" means providing a copy of the Package or making it accessible to anyone else, or in the case of a company or organization, to others outside of your company or organization.

"Distributor Fee" means any fee that you charge for Distributing this Package or providing support for this Package to another party. It does not mean licensing fees.

"Standard Version" refers to the Package if it has not been modified, or has been modified only in ways explicitly requested by the Copyright Holder.

"Modified Version" means the Package, if it has been changed, and such changes were not explicitly requested by the Copyright Holder.

"Original License" means this Artistic License as Distributed with the Standard Version of the Package, in its current version or as it may be modified by The Perl Foundation in the future.

"Source" form means the source code, documentation source, and configuration files for the Package.

"Compiled" form means the compiled bytecode, object code, binary, or any other form resulting from mechanical transformation or translation of the Source form.

#### Permission for Use and Modification Without Distribution

(1) You are permitted to use the Standard Version and create and use Modified Versions for any purpose without restriction, provided that you do not Distribute the Modified Version.

#### Permissions for Redistribution of the Standard Version

(2) You may Distribute verbatim copies of the Source form of the Standard Version of this Package in any medium without restriction, either gratis or for a Distributor Fee, provided that you duplicate all of the original copyright notices and associated disclaimers. At your discretion, such verbatim copies may or may not include a Compiled form of the Package.

(3) You may apply any bug fixes, portability changes, and other modifications made available from the Copyright Holder. The resulting Package will still be considered the Standard Version, and as such will be subject to the Original License.

#### Distribution of Modified Versions of the Package as Source

(4) You may Distribute your Modified Version as Source (either gratis or for a Distributor Fee, and with or without a Compiled form of the Modified Version) provided that you clearly document how it differs from the Standard Version, including, but not limited to, documenting any non-standard features, executables, or modules, and provided that you do at least ONE of the following:

(a) make the Modified Version available to the Copyright Holder of the Standard Version, under the Original License, so that the Copyright Holder may include your modifications in the Standard Version.

(b) ensure that installation of your Modified Version does not prevent the user installing or running the Standard Version. In addition, the Modified Version must bear a name that is different from the name of the Standard Version.

(c) allow anyone who receives a copy of the Modified Version to make the Source form of

the Modified Version available to others under

- (i) the Original License or
- (ii) a license that permits the licensee to freely copy, modify and redistribute the Modified Version using the same licensing terms that apply to the copy that the licensee received, and requires that the Source form of the Modified Version, and of any works derived from it, be made freely available in that license fees are prohibited but Distributor Fees are allowed.

#### Distribution of Compiled Forms of the Standard Version or Modified Versions without the Source

(5) You may Distribute Compiled forms of the Standard Version without the Source, provided that you include complete instructions on how to get the Source of the Standard Version. Such instructions must be valid at the time of your distribution. If these instructions, at any time while you are carrying out such distribution, become invalid, you must provide new instructions on demand or cease further distribution. If you provide valid instructions or cease distribution within thirty days after you become aware that the instructions are invalid, then you do not forfeit any of your rights under this license.

(6) You may Distribute a Modified Version in Compiled form without the Source, provided that you comply with Section 4 with respect to the Source of the Modified Version.

#### Aggregating or Linking the Package

(7) You may aggregate the Package (either the Standard Version or Modified Version) with other packages and Distribute the resulting aggregation provided that you do not charge a licensing fee for the Package. Distributor Fees are permitted, and licensing fees for other components in the aggregation are permitted. The terms of this license apply to the use and Distribution of the Standard or Modified Versions as included in the aggregation.

(8) You are permitted to link Modified and Standard Versions with other works, to embed the Package in a larger work of your own, or to build stand-alone binary or bytecode versions of applications that include the Package, and Distribute the result without restriction, provided the result does not expose a direct interface to the Package.

#### Items That are Not Considered Part of a Modified Version

(9) Works (including, but not limited to, modules and scripts) that merely extend or make use of the Package, do not, by themselves, cause the Package to be a Modified Version. In addition, such works are not considered parts of the Package itself, and are not subject to the terms of this license.

#### General Provisions

## General Provisions

(10) Any use, modification, and distribution of the Standard or Modified Versions is governed by this Artistic License. By using, modifying or distributing the Package, you accept this license. Do not use, modify, or distribute the Package, if you do not accept this license.

(11) If your Modified Version has been derived from a Modified Version made by someone other than you, you are nevertheless required to ensure that your Modified Version complies with the requirements of this license.

(12) This license does not grant you the right to use any trademark, service mark, tradename, or logo of the Copyright Holder.

(13) This license includes the non-exclusive, worldwide, free-of-charge patent license to make, have made, use, offer to sell, sell, import and otherwise transfer the Package with respect to any patent claims licensable by the Copyright Holder that are necessarily infringed by the Package. If you institute patent litigation (including a cross-claim or counterclaim) against any party alleging that the Package constitutes direct or contributory patent infringement, then this Artistic License to you shall terminate on the date that such litigation is filed.

(14) Disclaimer of Warranty:

THE PACKAGE IS PROVIDED BY THE COPYRIGHT HOLDER AND CONTRIBUTORS 'AS IS' AND WITHOUT ANY EXPRESS OR IMPLIED WARRANTIES. THE IMPLIED WARRANTIES OF MERCHANTABILITY, FITNESS FOR A PARTICULAR PURPOSE, OR NON-INFRINGEMENT ARE DISCLAIMED TO THE EXTENT PERMITTED BY YOUR LOCAL LAW. UNLESS REQUIRED BY LAW, NO COPYRIGHT HOLDER OR CONTRIBUTOR WILL BE LIABLE FOR ANY DIRECT, INDIRECT, INCIDENTAL, OR CONSEQUENTIAL DAMAGES ARISING IN ANY WAY OUT OF THE USE OF THE PACKAGE, EVEN IF ADVISED OF THE POSSIBILITY OF SUCH DAMAGE.

---

## BSD-2-Clause

Copyright (c) <year> <owner> All rights reserved.

Redistribution and use in source and binary forms, with or without modification, are permitted provided that the following conditions are met:

1. Redistributions of source code must retain the above copyright notice, this list of conditions and the following disclaimer.

2. Redistributions in binary form must reproduce the above copyright notice, this list of conditions and the following disclaimer in the documentation and/or other materials provided with the distribution.

THIS SOFTWARE IS PROVIDED BY THE COPYRIGHT HOLDERS AND CONTRIBUTORS "AS IS" AND ANY EXPRESS OR IMPLIED WARRANTIES, INCLUDING, BUT NOT LIMITED TO, THE IMPLIED WARRANTIES OF MERCHANTABILITY AND FITNESS FOR A PARTICULAR PURPOSE ARE DISCLAIMED. IN NO EVENT SHALL THE COPYRIGHT HOLDER OR CONTRIBUTORS BE LIABLE FOR ANY DIRECT, INDIRECT, INCIDENTAL, SPECIAL, EXEMPLARY, OR CONSEQUENTIAL DAMAGES (INCLUDING, BUT NOT LIMITED TO, PROCUREMENT OF SUBSTITUTE GOODS OR SERVICES; LOSS OF USE, DATA, OR PROFITS; OR BUSINESS INTERRUPTION) HOWEVER CAUSED AND ON ANY THEORY OF LIABILITY, WHETHER IN CONTRACT, STRICT LIABILITY, OR TORT (INCLUDING NEGLIGENCE OR OTHERWISE) ARISING IN ANY WAY OUT OF THE USE OF THIS SOFTWARE, EVEN IF ADVISED OF THE POSSIBILITY OF SUCH DAMAGE.

---

## **BSD-3-Clause**

Copyright (c) <year> <owner>. All rights reserved.

Redistribution and use in source and binary forms, with or without modification, are permitted provided that the following conditions are met:

1. Redistributions of source code must retain the above copyright notice, this list of conditions and the following disclaimer.
2. Redistributions in binary form must reproduce the above copyright notice, this list of conditions and the following disclaimer in the documentation and/or other materials provided with the distribution.
3. Neither the name of the copyright holder nor the names of its contributors may be used to endorse or promote products derived from this software without specific prior written permission.

THIS SOFTWARE IS PROVIDED BY THE COPYRIGHT HOLDERS AND CONTRIBUTORS "AS IS" AND ANY EXPRESS OR IMPLIED WARRANTIES, INCLUDING, BUT NOT LIMITED TO, THE IMPLIED WARRANTIES OF MERCHANTABILITY AND FITNESS FOR A PARTICULAR PURPOSE ARE DISCLAIMED. IN NO EVENT SHALL THE COPYRIGHT HOLDER OR CONTRIBUTORS BE

LIABLE FOR ANY DIRECT, INDIRECT, INCIDENTAL, SPECIAL, EXEMPLARY, OR CONSEQUENTIAL DAMAGES (INCLUDING, BUT NOT LIMITED TO, PROCUREMENT OF SUBSTITUTE GOODS OR SERVICES; LOSS OF USE, DATA, OR PROFITS; OR BUSINESS INTERRUPTION) HOWEVER CAUSED AND ON ANY THEORY OF LIABILITY, WHETHER IN CONTRACT, STRICT LIABILITY, OR TORT (INCLUDING NEGLIGENCE OR OTHERWISE) ARISING IN ANY WAY OUT OF THE USE OF THIS SOFTWARE, EVEN IF ADVISED OF THE POSSIBILITY OF SUCH DAMAGE.

---

## **BSD-like License (file)**

Redistribution and use in source and binary forms, with or without modification, are permitted provided that the following conditions are met:

1. Redistributions of source code must retain the above copyright notice immediately at the beginning of the file, without modification, this list of conditions, and the following disclaimer.
2. Redistributions in binary form must reproduce the above copyright notice, this list of conditions and the following disclaimer in the documentation and/or other materials provided with the distribution.

THIS SOFTWARE IS PROVIDED BY THE AUTHOR AND CONTRIBUTORS ``AS IS'' AND ANY EXPRESS OR IMPLIED WARRANTIES, INCLUDING, BUT NOT LIMITED TO, THE IMPLIED WARRANTIES OF MERCHANTABILITY AND FITNESS FOR A PARTICULAR PURPOSE ARE DISCLAIMED. IN NO EVENT SHALL THE AUTHOR OR CONTRIBUTORS BE LIABLE FOR ANY DIRECT, INDIRECT, INCIDENTAL, SPECIAL, EXEMPLARY, OR CONSEQUENTIAL DAMAGES (INCLUDING, BUT NOT LIMITED TO, PROCUREMENT OF SUBSTITUTE GOODS OR SERVICES; LOSS OF USE, DATA, OR PROFITS; OR BUSINESS INTERRUPTION) HOWEVER CAUSED AND ON ANY THEORY OF LIABILITY, WHETHER IN CONTRACT, STRICT LIABILITY, OR TORT (INCLUDING NEGLIGENCE OR OTHERWISE) ARISING IN ANY WAY OUT OF THE USE OF THIS SOFTWARE, EVEN IF ADVISED OF THE POSSIBILITY OF SUCH DAMAGE.

---

## **FTL**

The FreeType Project LICENSE

2006-Jan-27

Copyright 1996-2002, 2006 by David Turner, Robert Wilhelm, and Werner Lemberg

## Introduction

The FreeType Project is distributed in several archive packages; some of them may contain, in addition to the FreeType font engine, various tools and contributions which rely on, or relate to, the FreeType Project.

This license applies to all files found in such packages, and which do not fall under their own explicit license. The license affects thus the FreeType font engine, the test programs, documentation and makefiles, at the very least.

This license was inspired by the BSD, Artistic, and IJG (Independent JPEG Group) licenses, which all encourage inclusion and use of free software in commercial and freeware products alike. As a consequence, its main points are that:

- o We don't promise that this software works. However, we will be interested in any kind of bug reports. ('` as is' distribution)
- o You can use this software for whatever you want, in parts or full form, without having to pay us. ('` royalty-free' usage)
- o You may not pretend that you wrote this software. If you use it, or only parts of it, in a program, you must acknowledge somewhere in your documentation that you have used the FreeType code. ('` credits')

We specifically permit and encourage the inclusion of this software, with or without modifications, in commercial products. We disclaim all warranties covering The FreeType Project and assume no liability related to The FreeType Project.

Finally, many people asked us for a preferred form for a credit/disclaimer to use in compliance with this license. We thus encourage you to use the following text:

```
"" Portions of this software are copyright © <year> The FreeType Project  
(www.freetype.org). All rights reserved. ""
```

Please replace <year> with the value from the FreeType version you actually use.

## Legal Terms

### 0. Definitions

Throughout this license, the terms 'package', 'FreeType Project', and 'FreeType archive' refer to the set of files originally distributed by the authors (David Turner, Robert Wilhelm, and Werner Lemberg) as the 'FreeType Project', be they named as alpha, beta or final release.

'You' refers to the licensee, or person using the project, where 'using' is a generic term including compiling the project's source code as well as linking it to form a 'program' or 'executable'. This program is referred to as 'a program using the FreeType engine'.

This license applies to all files distributed in the original FreeType Project, including all source code, binaries and documentation, unless otherwise stated in the file in its original, unmodified form as distributed in the original archive. If you are unsure whether or not a particular file is covered by this license, you must contact us to verify this.

The FreeType Project is copyright (C) 1996-2000 by David Turner, Robert Wilhelm, and Werner Lemberg. All rights reserved except as specified below.

## 1. No Warranty

THE FREETYPE PROJECT IS PROVIDED 'AS IS' WITHOUT WARRANTY OF ANY KIND, EITHER EXPRESS OR IMPLIED, INCLUDING, BUT NOT LIMITED TO, WARRANTIES OF MERCHANTABILITY AND FITNESS FOR A PARTICULAR PURPOSE. IN NO EVENT WILL ANY OF THE AUTHORS OR COPYRIGHT HOLDERS BE LIABLE FOR ANY DAMAGES CAUSED BY THE USE OR THE INABILITY TO USE, OF THE FREETYPE PROJECT.

## 2. Redistribution

This license grants a worldwide, royalty-free, perpetual and irrevocable right and license to use, execute, perform, compile, display, copy, create derivative works of, distribute and sublicense the FreeType Project (in both source and object code forms) and derivative works thereof for any purpose; and to authorize others to exercise some or all of the rights granted herein, subject to the following conditions:

- o Redistribution of source code must retain this license file ('FTL.TXT') unaltered; any additions, deletions or changes to the original files must be clearly indicated in accompanying documentation. The copyright notices of the unaltered, original files must be preserved in all copies of source files.

- o Redistribution in binary form must provide a disclaimer that states that the software is based in part of the work of the FreeType Team, in the distribution documentation. We also encourage you to put an URL to the FreeType web page in your documentation, though this isn't mandatory.

These conditions apply to any software derived from or based on the FreeType Project, not just the unmodified files. If you use our work, you must acknowledge us. However, no fee need be paid to us.

### 3. Advertising

Neither the FreeType authors and contributors nor you shall use the name of the other for commercial, advertising, or promotional purposes without specific prior written permission.

We suggest, but do not require, that you use one or more of the following phrases to refer to this software in your documentation or advertising materials: `FreeType Project', `FreeType Engine', `FreeType library', or `FreeType Distribution'.

As you have not signed this license, you are not required to accept it. However, as the FreeType Project is copyrighted material, only this license, or another one contracted with the authors, grants you the right to use, distribute, and modify it. Therefore, by using, distributing, or modifying the FreeType Project, you indicate that you understand and accept all the terms of this license.

### 4. Contacts

There are two mailing lists related to FreeType:

o [freetype@nongnu.org](mailto:freetype@nongnu.org)

Discusses general use and applications of FreeType, as well as future and wanted additions to the library and distribution. If you are looking for support, start in this list if you haven't found anything to help you in the documentation.

o [freetype-devel@nongnu.org](mailto:freetype-devel@nongnu.org)

Discusses bugs, as well as engine internals, design issues, specific licenses, porting, etc.

Our home page can be found at

<http://www.freetype.org>

--- end of FTL.TXT ---

# GPL-2.0

## GNU GENERAL PUBLIC LICENSE

Version 2, June 1991

Copyright (C) 1989, 1991 Free Software Foundation, Inc.  
51 Franklin Street, Fifth Floor, Boston, MA 02110-1301, USA

Everyone is permitted to copy and distribute verbatim copies of this license document, but changing it is not allowed.

### Preamble

The licenses for most software are designed to take away your freedom to share and change it. By contrast, the GNU General Public License is intended to guarantee your freedom to share and change free software--to make sure the software is free for all its users. This General Public License applies to most of the Free Software Foundation's software and to any other program whose authors commit to using it. (Some other Free Software Foundation software is covered by the GNU Lesser General Public License instead.) You can apply it to your programs, too.

When we speak of free software, we are referring to freedom, not price. Our General Public Licenses are designed to make sure that you have the freedom to distribute copies of free software (and charge for this service if you wish), that you receive source code or can get it if you want it, that you can change the software or use pieces of it in new free programs; and that you know you can do these things.

To protect your rights, we need to make restrictions that forbid anyone to deny you these rights or to ask you to surrender the rights. These restrictions translate to certain responsibilities for you if you distribute copies of the software, or if you modify it.

For example, if you distribute copies of such a program, whether gratis or for a fee, you must give the recipients all the rights that you have. You must make sure that they, too, receive or can get the source code. And you must show them these terms so they know their rights.

We protect your rights with two steps: (1) copyright the software, and (2) offer you this license which gives you legal permission to copy, distribute and/or modify the software.

Also, for each author's protection and ours, we want to make certain that everyone understands that there is no warranty for this free software. If the software is modified by someone else and passed on, we want its recipients to know that what they have is not the original, so that any problems introduced by others will not reflect on the original authors'

reputations.

Finally, any free program is threatened constantly by software patents. We wish to avoid the danger that redistributors of a free program will individually obtain patent licenses, in effect making the program proprietary. To prevent this, we have made it clear that any patent must be licensed for everyone's free use or not licensed at all.

The precise terms and conditions for copying, distribution and modification follow.

## TERMS AND CONDITIONS FOR COPYING, DISTRIBUTION AND MODIFICATION

0. This License applies to any program or other work which contains a notice placed by the copyright holder saying it may be distributed under the terms of this General Public License. The "Program", below, refers to any such program or work, and a "work based on the Program" means either the Program or any derivative work under copyright law: that is to say, a work containing the Program or a portion of it, either verbatim or with modifications and/or translated into another language. (Hereinafter, translation is included without limitation in the term "modification".) Each licensee is addressed as "you".

Activities other than copying, distribution and modification are not covered by this License; they are outside its scope. The act of running the Program is not restricted, and the output from the Program is covered only if its contents constitute a work based on the Program (independent of having been made by running the Program). Whether that is true depends on what the Program does.

1. You may copy and distribute verbatim copies of the Program's source code as you receive it, in any medium, provided that you conspicuously and appropriately publish on each copy an appropriate copyright notice and disclaimer of warranty; keep intact all the notices that refer to this License and to the absence of any warranty; and give any other recipients of the Program a copy of this License along with the Program.

You may charge a fee for the physical act of transferring a copy, and you may at your option offer warranty protection in exchange for a fee.

2. You may modify your copy or copies of the Program or any portion of it, thus forming a work based on the Program, and copy and distribute such modifications or work under the terms of Section 1 above, provided that you also meet all of these conditions:

a) You must cause the modified files to carry prominent notices stating that you changed the files and the date of any change.

b) You must cause any work that you distribute or publish, that in whole or in part contains or is derived from the Program or any part thereof to be licensed as a whole at no charge

or is derived from the Program or any part thereof, to be licensed as a whole at no charge to all third parties under the terms of this License.

c) If the modified program normally reads commands interactively when run, you must cause it, when started running for such interactive use in the most ordinary way, to print or display an announcement including an appropriate copyright notice and a notice that there is no warranty (or else, saying that you provide a warranty) and that users may redistribute the program under these conditions, and telling the user how to view a copy of this License. (Exception: if the Program itself is interactive but does not normally print such an announcement, your work based on the Program is not required to print an announcement.)

These requirements apply to the modified work as a whole. If identifiable sections of that work are not derived from the Program, and can be reasonably considered independent and separate works in themselves, then this License, and its terms, do not apply to those sections when you distribute them as separate works. But when you distribute the same sections as part of a whole which is a work based on the Program, the distribution of the whole must be on the terms of this License, whose permissions for other licensees extend to the entire whole, and thus to each and every part regardless of who wrote it.

Thus, it is not the intent of this section to claim rights or contest your rights to work written entirely by you; rather, the intent is to exercise the right to control the distribution of derivative or collective works based on the Program.

In addition, mere aggregation of another work not based on the Program with the Program (or with a work based on the Program) on a volume of a storage or distribution medium does not bring the other work under the scope of this License.

3. You may copy and distribute the Program (or a work based on it, under Section 2) in object code or executable form under the terms of Sections 1 and 2 above provided that you also do one of the following:

a) Accompany it with the complete corresponding machine-readable source code, which must be distributed under the terms of Sections 1 and 2 above on a medium customarily used for software interchange; or,

b) Accompany it with a written offer, valid for at least three years, to give any third party, for a charge no more than your cost of physically performing source distribution, a complete machine-readable copy of the corresponding source code, to be distributed under the terms of Sections 1 and 2 above on a medium customarily used for software interchange; or,

c) Accompany it with the information you received as to the offer to distribute corresponding source code. (This alternative is allowed only for noncommercial

distribution and only if you received the program in object code or executable form with such an offer, in accord with Subsection b above.)

The source code for a work means the preferred form of the work for making modifications to it. For an executable work, complete source code means all the source code for all modules it contains, plus any associated interface definition files, plus the scripts used to control compilation and installation of the executable. However, as a special exception, the source code distributed need not include anything that is normally distributed (in either source or binary form) with the major components (compiler, kernel, and so on) of the operating system on which the executable runs, unless that component itself accompanies the executable.

If distribution of executable or object code is made by offering access to copy from a designated place, then offering equivalent access to copy the source code from the same place counts as distribution of the source code, even though third parties are not compelled to copy the source along with the object code.

4. You may not copy, modify, sublicense, or distribute the Program except as expressly provided under this License. Any attempt otherwise to copy, modify, sublicense or distribute the Program is void, and will automatically terminate your rights under this License. However, parties who have received copies, or rights, from you under this License will not have their licenses terminated so long as such parties remain in full compliance.

5. You are not required to accept this License, since you have not signed it. However, nothing else grants you permission to modify or distribute the Program or its derivative works. These actions are prohibited by law if you do not accept this License. Therefore, by modifying or distributing the Program (or any work based on the Program), you indicate your acceptance of this License to do so, and all its terms and conditions for copying, distributing or modifying the Program or works based on it.

6. Each time you redistribute the Program (or any work based on the Program), the recipient automatically receives a license from the original licensor to copy, distribute or modify the Program subject to these terms and conditions. You may not impose any further restrictions on the recipients' exercise of the rights granted herein. You are not responsible for enforcing compliance by third parties to this License.

7. If, as a consequence of a court judgment or allegation of patent infringement or for any other reason (not limited to patent issues), conditions are imposed on you (whether by court order, agreement or otherwise) that contradict the conditions of this License, they do not excuse you from the conditions of this License. If you cannot distribute so as to satisfy simultaneously your obligations under this License and any other pertinent obligations, then as a consequence you may not distribute the Program at all. For example, if a patent license would not permit royalty-free redistribution of the Program by all those who receive copies directly or indirectly through you, then the only way you could satisfy both it

and this License would be to refrain entirely from distribution of the Program.

If any portion of this section is held invalid or unenforceable under any particular circumstance, the balance of the section is intended to apply and the section as a whole is intended to apply in other circumstances.

It is not the purpose of this section to induce you to infringe any patents or other property right claims or to contest validity of any such claims; this section has the sole purpose of protecting the integrity of the free software distribution system, which is implemented by public license practices. Many people have made generous contributions to the wide range of software distributed through that system in reliance on consistent application of that system; it is up to the author/donor to decide if he or she is willing to distribute software through any other system and a licensee cannot impose that choice.

This section is intended to make thoroughly clear what is believed to be a consequence of the rest of this License.

8. If the distribution and/or use of the Program is restricted in certain countries either by patents or by copyrighted interfaces, the original copyright holder who places the Program under this License may add an explicit geographical distribution limitation excluding those countries, so that distribution is permitted only in or among countries not thus excluded. In such case, this License incorporates the limitation as if written in the body of this License.

9. The Free Software Foundation may publish revised and/or new versions of the General Public License from time to time. Such new versions will be similar in spirit to the present version, but may differ in detail to address new problems or concerns.

Each version is given a distinguishing version number. If the Program specifies a version number of this License which applies to it and "any later version", you have the option of following the terms and conditions either of that version or of any later version published by the Free Software Foundation. If the Program does not specify a version number of this License, you may choose any version ever published by the Free Software Foundation.

10. If you wish to incorporate parts of the Program into other free programs whose distribution conditions are different, write to the author to ask for permission. For software which is copyrighted by the Free Software Foundation, write to the Free Software Foundation; we sometimes make exceptions for this. Our decision will be guided by the two goals of preserving the free status of all derivatives of our free software and of promoting the sharing and reuse of software generally.

NO WARRANTY

11. BECAUSE THE PROGRAM IS LICENSED FREE OF CHARGE, THERE IS NO WARRANTY FOR THE PROGRAM TO THE EXTENT PERMITTED BY APPLICABLE LAW EXCEPT WHEN

THE PROGRAM, TO THE EXTENT PERMITTED BY APPLICABLE LAW. EXCEPT WHEN OTHERWISE STATED IN WRITING THE COPYRIGHT HOLDERS AND/OR OTHER PARTIES PROVIDE THE PROGRAM "AS IS" WITHOUT WARRANTY OF ANY KIND, EITHER EXPRESSED OR IMPLIED, INCLUDING, BUT NOT LIMITED TO, THE IMPLIED WARRANTIES OF MERCHANTABILITY AND FITNESS FOR A PARTICULAR PURPOSE. THE ENTIRE RISK AS TO THE QUALITY AND PERFORMANCE OF THE PROGRAM IS WITH YOU. SHOULD THE PROGRAM PROVE DEFECTIVE, YOU ASSUME THE COST OF ALL NECESSARY SERVICING, REPAIR OR CORRECTION.

12. IN NO EVENT UNLESS REQUIRED BY APPLICABLE LAW OR AGREED TO IN WRITING WILL ANY COPYRIGHT HOLDER, OR ANY OTHER PARTY WHO MAY MODIFY AND/OR REDISTRIBUTE THE PROGRAM AS PERMITTED ABOVE, BE LIABLE TO YOU FOR DAMAGES, INCLUDING ANY GENERAL, SPECIAL, INCIDENTAL OR CONSEQUENTIAL DAMAGES ARISING OUT OF THE USE OR INABILITY TO USE THE PROGRAM (INCLUDING BUT NOT LIMITED TO LOSS OF DATA OR DATA BEING RENDERED INACCURATE OR LOSSES SUSTAINED BY YOU OR THIRD PARTIES OR A FAILURE OF THE PROGRAM TO OPERATE WITH ANY OTHER PROGRAMS), EVEN IF SUCH HOLDER OR OTHER PARTY HAS BEEN ADVISED OF THE POSSIBILITY OF SUCH DAMAGES.

## END OF TERMS AND CONDITIONS

### How to Apply These Terms to Your New Programs

If you develop a new program, and you want it to be of the greatest possible use to the public, the best way to achieve this is to make it free software which everyone can redistribute and change under these terms.

To do so, attach the following notices to the program. It is safest to attach them to the start of each source file to most effectively convey the exclusion of warranty; and each file should have at least the "copyright" line and a pointer to where the full notice is found.

one line to give the program's name and an idea of what it does. Copyright (C) yyyy name of author

This program is free software; you can redistribute it and/or modify it under the terms of the GNU General Public License as published by the Free Software Foundation; either version 2 of the License, or (at your option) any later version.

This program is distributed in the hope that it will be useful, but WITHOUT ANY WARRANTY; without even the implied warranty of MERCHANTABILITY or FITNESS FOR A PARTICULAR PURPOSE. See the GNU General Public License for more details.

You should have received a copy of the GNU General Public License along with this program; if not, write to the Free Software Foundation, Inc., 51 Franklin Street, Fifth Floor, Boston, MA 02110-1301, USA. Also add information on how to contact you by electronic and

..

paper mail.

If the program is interactive, make it output a short notice like this when it starts in an interactive mode:

Gnomovision version 69, Copyright (C) year name of author Gnomovision comes with ABSOLUTELY NO WARRANTY; for details type `show w'. This is free software, and you are welcome to redistribute it under certain conditions; type `show c' for details.

The hypothetical commands `show w' and `show c' should show the appropriate parts of the General Public License. Of course, the commands you use may be called something other than `show w' and `show c'; they could even be mouse-clicks or menu items-- whatever suits your program.

You should also get your employer (if you work as a programmer) or your school, if any, to sign a "copyright disclaimer" for the program, if necessary. Here is a sample; alter the names:

Yoyodyne, Inc., hereby disclaims all copyright interest in the program `Gnomovision' (which makes passes at compilers) written by James Hacker.

signature of Ty Coon, 1 April 1989 Ty Coon, President of Vice

---

## HPND

Permission to use, copy, modify and distribute this software and its documentation for any purpose and without fee is hereby granted, provided that the above copyright notice appear in all copies[, ] [and] that both [that] [the] copyright notice and this permission notice appear in supporting documentation[, and that the name [of] <copyright holder> [or <related entities>] not be used in advertising or publicity pertaining to distribution of the software without specific, written prior permission]. [<copyright holder> makes no representations about the suitability of this software for any purpose. It is provided "as is" without express or implied warranty.]

[<copyright holder> DISCLAIMS ALL WARRANTIES WITH REGARD TO THIS SOFTWARE, INCLUDING ALL IMPLIED WARRANTIES OF MERCHANTABILITY AND FITNESS[.][.] IN NO EVENT SHALL <copyright holder> BE LIABLE FOR ANY SPECIAL, INDIRECT OR CONSEQUENTIAL DAMAGES OR ANY DAMAGES WHATSOEVER RESULTING FROM LOSS OF USE, DATA OR PROFITS, WHETHER IN AN ACTION OF CONTRACT, NEGLIGENCE OR OTHER TORTIOUS ACTION, ARISING OUT OF OR IN CONNECTION WITH THE USE OR PERFORMANCE

OF THIS SOFTWARE.]

---

## ICU

Permission is hereby granted, free of charge, to any person obtaining a copy of this software and associated documentation files (the "Software"), to deal in the Software without restriction, including without limitation the rights to use, copy, modify, merge, publish, distribute, and/or sell copies of the Software, and to permit persons to whom the Software is furnished to do so, provided that the above copyright notice(s) and this permission notice appear in all copies of the Software and that both the above copyright notice(s) and this permission notice appear in supporting documentation.

THE SOFTWARE IS PROVIDED "AS IS", WITHOUT WARRANTY OF ANY KIND, EXPRESS OR IMPLIED, INCLUDING BUT NOT LIMITED TO THE WARRANTIES OF MERCHANTABILITY, FITNESS FOR A PARTICULAR PURPOSE AND NONINFRINGEMENT OF THIRD PARTY RIGHTS. IN NO EVENT SHALL THE COPYRIGHT HOLDER OR HOLDERS INCLUDED IN THIS NOTICE BE LIABLE FOR ANY CLAIM, OR ANY SPECIAL INDIRECT OR CONSEQUENTIAL DAMAGES, OR ANY DAMAGES WHATSOEVER RESULTING FROM LOSS OF USE, DATA OR PROFITS, WHETHER IN AN ACTION OF CONTRACT, NEGLIGENCE OR OTHER TORTIOUS ACTION, ARISING OUT OF OR IN CONNECTION WITH THE USE OR PERFORMANCE OF THIS SOFTWARE.

Except as contained in this notice, the name of a copyright holder shall not be used in advertising or otherwise to promote the sale, use or other dealings in this Software without prior written authorization of the copyright holder.

---

## IJG

Independent JPEG Group License

LEGAL ISSUES

In plain English:

1. We don't promise that this software works. (But if you find any bugs, please let us know!)
2. You can use this software for whatever you want. You don't have to pay us.

3. You may not pretend that you wrote this software. If you use it in a program, you must acknowledge somewhere in your documentation that you've used the IJG code.

In legalese:

The authors make NO WARRANTY or representation, either express or implied, with respect to this software, its quality, accuracy, merchantability, or fitness for a particular purpose. This software is provided "AS IS", and you, its user, assume the entire risk as to its quality and accuracy.

This software is copyright (C) 1991-1998, Thomas G. Lane. All Rights Reserved except as specified below.

Permission is hereby granted to use, copy, modify, and distribute this software (or portions thereof) for any purpose, without fee, subject to these conditions:

(1) If any part of the source code for this software is distributed, then this README file must be included, with this copyright and no-warranty notice unaltered; and any additions, deletions, or changes to the original files must be clearly indicated in accompanying documentation.

(2) If only executable code is distributed, then the accompanying documentation must state that "this software is based in part on the work of the Independent JPEG Group".

(3) Permission for use of this software is granted only if the user accepts full responsibility for any undesirable consequences; the authors accept NO LIABILITY for damages of any kind.

These conditions apply to any software derived from or based on the IJG code, not just to the unmodified library. If you use our work, you ought to acknowledge us.

Permission is NOT granted for the use of any IJG author's name or company name in advertising or publicity relating to this software or products derived from it. This software may be referred to only as "the Independent JPEG Group's software".

We specifically permit and encourage the use of this software as the basis of commercial products, provided that all warranty or liability claims are assumed by the product vendor.

ansi2knr.c is included in this distribution by permission of L. Peter Deutsch, sole proprietor of its copyright holder, Aladdin Enterprises of Menlo Park, CA. ansi2knr.c is NOT covered by the above copyright and conditions, but instead by the usual distribution terms of the Free Software Foundation; principally, that you must include source code if you redistribute it. (See the file ansi2knr.c for full details.) However, since ansi2knr.c is not needed as part of any program generated from the IJG code, this does not limit you more than the foregoing paragraphs do.

The Unix configuration script "configure" was produced with GNU Autoconf. It is copyright by the Free Software Foundation but is freely distributable. The same holds for its supporting scripts (config.guess, config.sub, ltconfig, ltmain.sh). Another support script, install-sh, is copyright by M.I.T. but is also freely distributable.

It appears that the arithmetic coding option of the JPEG spec is covered by patents owned by IBM, AT&T, and Mitsubishi. Hence arithmetic coding cannot legally be used without obtaining one or more licenses. For this reason, support for arithmetic coding has been removed from the free JPEG software. (Since arithmetic coding provides only a marginal gain over the unpatented Huffman mode, it is unlikely that very many implementations will support it.) So far as we are aware, there are no patent restrictions on the remaining code.

The IJG distribution formerly included code to read and write GIF files. To avoid entanglement with the Unisys LZW patent, GIF reading support has been removed altogether, and the GIF writer has been simplified to produce "uncompressed GIFs". This technique does not use the LZW algorithm; the resulting GIF files are larger than usual, but are readable by all standard GIF decoders.

We are required to state that

"The Graphics Interchange Format(c) is the Copyright property of CompuServe Incorporated. GIF(sm) is a Service Mark property of CompuServe Incorporated."

---

## ISC

Permission to use, copy, modify, and/or distribute this software for any purpose with or without fee is hereby granted, provided that the above copyright notice and this permission notice appear in all copies.

THE SOFTWARE IS PROVIDED "AS IS" AND THE AUTHOR DISCLAIMS ALL WARRANTIES WITH REGARD TO THIS SOFTWARE INCLUDING ALL IMPLIED WARRANTIES OF MERCHANTABILITY AND FITNESS. IN NO EVENT SHALL THE AUTHOR BE LIABLE FOR ANY SPECIAL, DIRECT, INDIRECT, OR CONSEQUENTIAL DAMAGES OR ANY DAMAGES WHATSOEVER RESULTING FROM LOSS OF USE, DATA OR PROFITS, WHETHER IN AN ACTION OF CONTRACT, NEGLIGENCE OR OTHER TORTIOUS ACTION, ARISING OUT OF OR IN CONNECTION WITH THE USE OR PERFORMANCE OF THIS SOFTWARE.

---

# LGPL-2.1

## GNU LESSER GENERAL PUBLIC LICENSE

Version 2.1, February 1999

Copyright (C) 1991, 1999 Free Software Foundation, Inc.  
51 Franklin Street, Fifth Floor, Boston, MA 02110-1301 USA

Everyone is permitted to copy and distribute verbatim copies of this license document, but changing it is not allowed.

[This is the first released version of the Lesser GPL. It also counts as the successor of the GNU Library Public License, version 2, hence the version number 2.1.]

### Preamble

The licenses for most software are designed to take away your freedom to share and change it. By contrast, the GNU General Public Licenses are intended to guarantee your freedom to share and change free software--to make sure the software is free for all its users.

This license, the Lesser General Public License, applies to some specially designated software packages--typically libraries--of the Free Software Foundation and other authors who decide to use it. You can use it too, but we suggest you first think carefully about whether this license or the ordinary General Public License is the better strategy to use in any particular case, based on the explanations below.

When we speak of free software, we are referring to freedom of use, not price. Our General Public Licenses are designed to make sure that you have the freedom to distribute copies of free software (and charge for this service if you wish); that you receive source code or can get it if you want it; that you can change the software and use pieces of it in new free programs; and that you are informed that you can do these things.

To protect your rights, we need to make restrictions that forbid distributors to deny you these rights or to ask you to surrender these rights. These restrictions translate to certain responsibilities for you if you distribute copies of the library or if you modify it.

For example, if you distribute copies of the library, whether gratis or for a fee, you must give the recipients all the rights that we gave you. You must make sure that they, too, receive or can get the source code. If you link other code with the library, you must provide complete object files to the recipients, so that they can relink them with the library after making changes to the library and recompiling it. And you must show them these terms so

making changes to the library and recompiling it. And you must show them these terms so they know their rights.

We protect your rights with a two-step method: (1) we copyright the library, and (2) we offer you this license, which gives you legal permission to copy, distribute and/or modify the library.

To protect each distributor, we want to make it very clear that there is no warranty for the free library. Also, if the library is modified by someone else and passed on, the recipients should know that what they have is not the original version, so that the original author's reputation will not be affected by problems that might be introduced by others.

Finally, software patents pose a constant threat to the existence of any free program. We wish to make sure that a company cannot effectively restrict the users of a free program by obtaining a restrictive license from a patent holder. Therefore, we insist that any patent license obtained for a version of the library must be consistent with the full freedom of use specified in this license.

Most GNU software, including some libraries, is covered by the ordinary GNU General Public License. This license, the GNU Lesser General Public License, applies to certain designated libraries, and is quite different from the ordinary General Public License. We use this license for certain libraries in order to permit linking those libraries into non-free programs.

When a program is linked with a library, whether statically or using a shared library, the combination of the two is legally speaking a combined work, a derivative of the original library. The ordinary General Public License therefore permits such linking only if the entire combination fits its criteria of freedom. The Lesser General Public License permits more lax criteria for linking other code with the library.

We call this license the "Lesser" General Public License because it does Less to protect the user's freedom than the ordinary General Public License. It also provides other free software developers Less of an advantage over competing non-free programs. These disadvantages are the reason we use the ordinary General Public License for many libraries. However, the Lesser license provides advantages in certain special circumstances.

For example, on rare occasions, there may be a special need to encourage the widest possible use of a certain library, so that it becomes a de-facto standard. To achieve this, non-free programs must be allowed to use the library. A more frequent case is that a free library does the same job as widely used non-free libraries. In this case, there is little to gain by limiting the free library to free software only, so we use the Lesser General Public License.

In other cases, permission to use a particular library in non-free programs enables a greater number of people to use a large body of free software. For example, permission to use the GNU C Library in non-free programs enables many more people to use the whole GNU operating system, as well as its variant, the GNU/Linux operating system.

Although the Lesser General Public License is Less protective of the users' freedom, it does ensure that the user of a program that is linked with the Library has the freedom and the wherewithal to run that program using a modified version of the Library.

The precise terms and conditions for copying, distribution and modification follow. Pay close attention to the difference between a "work based on the library" and a "work that uses the library". The former contains code derived from the library, whereas the latter must be combined with the library in order to run.

## TERMS AND CONDITIONS FOR COPYING, DISTRIBUTION AND MODIFICATION

0. This License Agreement applies to any software library or other program which contains a notice placed by the copyright holder or other authorized party saying it may be distributed under the terms of this Lesser General Public License (also called "this License"). Each licensee is addressed as "you".

A "library" means a collection of software functions and/or data prepared so as to be conveniently linked with application programs (which use some of those functions and data) to form executables.

The "Library", below, refers to any such software library or work which has been distributed under these terms. A "work based on the Library" means either the Library or any derivative work under copyright law: that is to say, a work containing the Library or a portion of it, either verbatim or with modifications and/or translated straightforwardly into another language. (Hereinafter, translation is included without limitation in the term "modification".)

"Source code" for a work means the preferred form of the work for making modifications to it. For a library, complete source code means all the source code for all modules it contains, plus any associated interface definition files, plus the scripts used to control compilation and installation of the library.

Activities other than copying, distribution and modification are not covered by this License; they are outside its scope. The act of running a program using the Library is not restricted, and output from such a program is covered only if its contents constitute a work based on the Library (independent of the use of the Library in a tool for writing it). Whether that is true depends on what the Library does and what the program that uses the Library does.

1. You may copy and distribute verbatim copies of the Library's complete source code as

you receive it, in any medium, provided that you conspicuously and appropriately publish on each copy an appropriate copyright notice and disclaimer of warranty; keep intact all the notices that refer to this License and to the absence of any warranty; and distribute a copy of this License along with the Library.

You may charge a fee for the physical act of transferring a copy, and you may at your option offer warranty protection in exchange for a fee.

2. You may modify your copy or copies of the Library or any portion of it, thus forming a work based on the Library, and copy and distribute such modifications or work under the terms of Section 1 above, provided that you also meet all of these conditions:

a) The modified work must itself be a software library.

b) You must cause the files modified to carry prominent notices stating that you changed the files and the date of any change.

c) You must cause the whole of the work to be licensed at no charge to all third parties under the terms of this License.

d) If a facility in the modified Library refers to a function or a table of data to be supplied by an application program that uses the facility, other than as an argument passed when the facility is invoked, then you must make a good faith effort to ensure that, in the event an application does not supply such function or table, the facility still operates, and performs whatever part of its purpose remains meaningful.

(For example, a function in a library to compute square roots has a purpose that is entirely well-defined independent of the application. Therefore, Subsection 2d requires that any application-supplied function or table used by this function must be optional: if the application does not supply it, the square root function must still compute square roots.)

These requirements apply to the modified work as a whole. If identifiable sections of that work are not derived from the Library, and can be reasonably considered independent and separate works in themselves, then this License, and its terms, do not apply to those sections when you distribute them as separate works. But when you distribute the same sections as part of a whole which is a work based on the Library, the distribution of the whole must be on the terms of this License, whose permissions for other licensees extend to the entire whole, and thus to each and every part regardless of who wrote it.

Thus, it is not the intent of this section to claim rights or contest your rights to work written entirely by you; rather, the intent is to exercise the right to control the distribution of derivative or collective works based on the Library.

In addition, mere aggregation of another work not based on the Library with the Library (or

in addition, mere aggregation of another work not based on the Library with the Library (or with a work based on the Library) on a volume of a storage or distribution medium does not bring the other work under the scope of this License.

3. You may opt to apply the terms of the ordinary GNU General Public License instead of this License to a given copy of the Library. To do this, you must alter all the notices that refer to this License, so that they refer to the ordinary GNU General Public License, version 2, instead of to this License. (If a newer version than version 2 of the ordinary GNU General Public License has appeared, then you can specify that version instead if you wish.) Do not make any other change in these notices.

Once this change is made in a given copy, it is irreversible for that copy, so the ordinary GNU General Public License applies to all subsequent copies and derivative works made from that copy.

This option is useful when you wish to copy part of the code of the Library into a program that is not a library.

4. You may copy and distribute the Library (or a portion or derivative of it, under Section 2) in object code or executable form under the terms of Sections 1 and 2 above provided that you accompany it with the complete corresponding machine-readable source code, which must be distributed under the terms of Sections 1 and 2 above on a medium customarily used for software interchange.

If distribution of object code is made by offering access to copy from a designated place, then offering equivalent access to copy the source code from the same place satisfies the requirement to distribute the source code, even though third parties are not compelled to copy the source along with the object code.

5. A program that contains no derivative of any portion of the Library, but is designed to work with the Library by being compiled or linked with it, is called a "work that uses the Library". Such a work, in isolation, is not a derivative work of the Library, and therefore falls outside the scope of this License.

However, linking a "work that uses the Library" with the Library creates an executable that is a derivative of the Library (because it contains portions of the Library), rather than a "work that uses the library". The executable is therefore covered by this License. Section 6 states terms for distribution of such executables.

When a "work that uses the Library" uses material from a header file that is part of the Library, the object code for the work may be a derivative work of the Library even though the source code is not. Whether this is true is especially significant if the work can be linked without the Library, or if the work is itself a library. The threshold for this to be true is not precisely defined by law.

If such an object file uses only numerical parameters, data structure layouts and accessors, and small macros and small inline functions (ten lines or less in length), then the use of the object file is unrestricted, regardless of whether it is legally a derivative work. (Executables containing this object code plus portions of the Library will still fall under Section 6.)

Otherwise, if the work is a derivative of the Library, you may distribute the object code for the work under the terms of Section 6. Any executables containing that work also fall under Section 6, whether or not they are linked directly with the Library itself.

6. As an exception to the Sections above, you may also combine or link a "work that uses the Library" with the Library to produce a work containing portions of the Library, and distribute that work under terms of your choice, provided that the terms permit modification of the work for the customer's own use and reverse engineering for debugging such modifications.

You must give prominent notice with each copy of the work that the Library is used in it and that the Library and its use are covered by this License. You must supply a copy of this License. If the work during execution displays copyright notices, you must include the copyright notice for the Library among them, as well as a reference directing the user to the copy of this License. Also, you must do one of these things:

a) Accompany the work with the complete corresponding machine-readable source code for the Library including whatever changes were used in the work (which must be distributed under Sections 1 and 2 above); and, if the work is an executable linked with the Library, with the complete machine-readable "work that uses the Library", as object code and/or source code, so that the user can modify the Library and then relink to produce a modified executable containing the modified Library. (It is understood that the user who changes the contents of definitions files in the Library will not necessarily be able to recompile the application to use the modified definitions.)

b) Use a suitable shared library mechanism for linking with the Library. A suitable mechanism is one that (1) uses at run time a copy of the library already present on the user's computer system, rather than copying library functions into the executable, and (2) will operate properly with a modified version of the library, if the user installs one, as long as the modified version is interface-compatible with the version that the work was made with.

c) Accompany the work with a written offer, valid for at least three years, to give the same user the materials specified in Subsection 6a, above, for a charge no more than the cost of performing this distribution.

d) If distribution of the work is made by offering access to copy from a designated place, offer equivalent access to copy the above specified materials from the same place.

e) Verify that the user has already received a copy of these materials or that you have already sent this user a copy.

For an executable, the required form of the "work that uses the Library" must include any data and utility programs needed for reproducing the executable from it. However, as a special exception, the materials to be distributed need not include anything that is normally distributed (in either source or binary form) with the major components (compiler, kernel, and so on) of the operating system on which the executable runs, unless that component itself accompanies the executable.

It may happen that this requirement contradicts the license restrictions of other proprietary libraries that do not normally accompany the operating system. Such a contradiction means you cannot use both them and the Library together in an executable that you distribute.

7. You may place library facilities that are a work based on the Library side-by-side in a single library together with other library facilities not covered by this License, and distribute such a combined library, provided that the separate distribution of the work based on the Library and of the other library facilities is otherwise permitted, and provided that you do these two things:

a) Accompany the combined library with a copy of the same work based on the Library, uncombined with any other library facilities. This must be distributed under the terms of the Sections above.

b) Give prominent notice with the combined library of the fact that part of it is a work based on the Library, and explaining where to find the accompanying uncombined form of the same work.

8. You may not copy, modify, sublicense, link with, or distribute the Library except as expressly provided under this License. Any attempt otherwise to copy, modify, sublicense, link with, or distribute the Library is void, and will automatically terminate your rights under this License. However, parties who have received copies, or rights, from you under this License will not have their licenses terminated so long as such parties remain in full compliance.

9. You are not required to accept this License, since you have not signed it. However, nothing else grants you permission to modify or distribute the Library or its derivative works. These actions are prohibited by law if you do not accept this License. Therefore, by modifying or distributing the Library (or any work based on the Library), you indicate your acceptance of this License to do so, and all its terms and conditions for copying, distributing or modifying the Library or works based on it.

10. Each time you redistribute the Library (or any work based on the Library), the recipient automatically receives a license from the original licensor to copy, distribute, link with or modify the Library subject to these terms and conditions. You may not impose any further restrictions on the recipients' exercise of the rights granted herein. You are not responsible for enforcing compliance by third parties with this License.

11. If, as a consequence of a court judgment or allegation of patent infringement or for any other reason (not limited to patent issues), conditions are imposed on you (whether by court order, agreement or otherwise) that contradict the conditions of this License, they do not excuse you from the conditions of this License. If you cannot distribute so as to satisfy simultaneously your obligations under this License and any other pertinent obligations, then as a consequence you may not distribute the Library at all. For example, if a patent license would not permit royalty-free redistribution of the Library by all those who receive copies directly or indirectly through you, then the only way you could satisfy both it and this License would be to refrain entirely from distribution of the Library.

If any portion of this section is held invalid or unenforceable under any particular circumstance, the balance of the section is intended to apply, and the section as a whole is intended to apply in other circumstances.

It is not the purpose of this section to induce you to infringe any patents or other property right claims or to contest validity of any such claims; this section has the sole purpose of protecting the integrity of the free software distribution system which is implemented by public license practices. Many people have made generous contributions to the wide range of software distributed through that system in reliance on consistent application of that system; it is up to the author/donor to decide if he or she is willing to distribute software through any other system and a licensee cannot impose that choice.

This section is intended to make thoroughly clear what is believed to be a consequence of the rest of this License.

12. If the distribution and/or use of the Library is restricted in certain countries either by patents or by copyrighted interfaces, the original copyright holder who places the Library under this License may add an explicit geographical distribution limitation excluding those countries, so that distribution is permitted only in or among countries not thus excluded. In such case, this License incorporates the limitation as if written in the body of this License.

13. The Free Software Foundation may publish revised and/or new versions of the Lesser General Public License from time to time. Such new versions will be similar in spirit to the present version, but may differ in detail to address new problems or concerns.

Each version is given a distinguishing version number. If the Library specifies a version number of this License which applies to it and "any later version", you have the option of

following the terms and conditions either of that version or of any later version published by the Free Software Foundation. If the Library does not specify a license version number, you may choose any version ever published by the Free Software Foundation.

14. If you wish to incorporate parts of the Library into other free programs whose distribution conditions are incompatible with these, write to the author to ask for permission. For software which is copyrighted by the Free Software Foundation, write to the Free Software Foundation; we sometimes make exceptions for this. Our decision will be guided by the two goals of preserving the free status of all derivatives of our free software and of promoting the sharing and reuse of software generally.

## NO WARRANTY

15. BECAUSE THE LIBRARY IS LICENSED FREE OF CHARGE, THERE IS NO WARRANTY FOR THE LIBRARY, TO THE EXTENT PERMITTED BY APPLICABLE LAW. EXCEPT WHEN OTHERWISE STATED IN WRITING THE COPYRIGHT HOLDERS AND/OR OTHER PARTIES PROVIDE THE LIBRARY "AS IS" WITHOUT WARRANTY OF ANY KIND, EITHER EXPRESSED OR IMPLIED, INCLUDING, BUT NOT LIMITED TO, THE IMPLIED WARRANTIES OF MERCHANTABILITY AND FITNESS FOR A PARTICULAR PURPOSE. THE ENTIRE RISK AS TO THE QUALITY AND PERFORMANCE OF THE LIBRARY IS WITH YOU. SHOULD THE LIBRARY PROVE DEFECTIVE, YOU ASSUME THE COST OF ALL NECESSARY SERVICING, REPAIR OR CORRECTION.

16. IN NO EVENT UNLESS REQUIRED BY APPLICABLE LAW OR AGREED TO IN WRITING WILL ANY COPYRIGHT HOLDER, OR ANY OTHER PARTY WHO MAY MODIFY AND/OR REDISTRIBUTE THE LIBRARY AS PERMITTED ABOVE, BE LIABLE TO YOU FOR DAMAGES, INCLUDING ANY GENERAL, SPECIAL, INCIDENTAL OR CONSEQUENTIAL DAMAGES ARISING OUT OF THE USE OR INABILITY TO USE THE LIBRARY (INCLUDING BUT NOT LIMITED TO LOSS OF DATA OR DATA BEING RENDERED INACCURATE OR LOSSES SUSTAINED BY YOU OR THIRD PARTIES OR A FAILURE OF THE LIBRARY TO OPERATE WITH ANY OTHER SOFTWARE), EVEN IF SUCH HOLDER OR OTHER PARTY HAS BEEN ADVISED OF THE POSSIBILITY OF SUCH DAMAGES.

## END OF TERMS AND CONDITIONS

### How to Apply These Terms to Your New Libraries

If you develop a new library, and you want it to be of the greatest possible use to the public, we recommend making it free software that everyone can redistribute and change. You can do so by permitting redistribution under these terms (or, alternatively, under the terms of the ordinary General Public License).

To apply these terms, attach the following notices to the library. It is safest to attach them to the start of each source file to most effectively convey the exclusion of warranty; and each file should have at least the "copyright" line and a pointer to where the full notice is found.

one line to give the library's name and an idea of what it does.

Copyright (C) year name of author

This library is free software; you can redistribute it and/or modify it under the terms of the GNU Lesser General Public License as published by the Free Software Foundation; either version 2.1 of the License, or (at your option) any later version.

This library is distributed in the hope that it will be useful, but WITHOUT ANY WARRANTY; without even the implied warranty of MERCHANTABILITY or FITNESS FOR A PARTICULAR PURPOSE. See the GNU Lesser General Public License for more details.

You should have received a copy of the GNU Lesser General Public License along with this library; if not, write to the Free Software Foundation, Inc., 51 Franklin Street, Fifth Floor, Boston, MA 02110-1301 USA Also add information on how to contact you by electronic and paper mail.

You should also get your employer (if you work as a programmer) or your school, if any, to sign a "copyright disclaimer" for the library, if necessary. Here is a sample; alter the names:

Yoyodyne, Inc., hereby disclaims all copyright interest in  
the library `Frob' (a library for tweaking knobs) written  
by James Random Hacker.

signature of Ty Coon, 1 April 1990

Ty Coon, President of Vice

That's all there is to it!

---

## Libpng

This copy of the libpng notices is provided for your convenience. In case of any discrepancy between this copy and the notices in the file png.h that is included in the libpng distribution, the latter shall prevail.

COPYRIGHT NOTICE, DISCLAIMER, and LICENSE:

If you modify libpng you may insert additional notices immediately following this sentence.

This code is released under the libpng license.

libpng versions 1.2.6, August 15, 2004, through 1.4.5, December 9, 2010, are Copyright (c) 2004, 2006-2010 Glenn Randers-Pehrson, and are distributed according to the same disclaimer and license as libpng-1.2.5 with the following individual added to the list of Contributing Authors

Cosmin Truta

libpng versions 1.0.7, July 1, 2000, through 1.2.5 - October 3, 2002, are Copyright (c) 2000-2002 Glenn Randers-Pehrson, and are distributed according to the same disclaimer and license as libpng-1.0.6 with the following individuals added to the list of Contributing Authors

Simon-Pierre Cadieux  
Eric S. Raymond  
Gilles Vollant

and with the following additions to the disclaimer:

There is no warranty against interference with your enjoyment of the library or against infringement. There is no warranty that our efforts or the library will fulfill any of your particular purposes or needs. This library is provided with all faults, and the entire risk of satisfactory quality, performance, accuracy, and effort is with the user.

libpng versions 0.97, January 1998, through 1.0.6, March 20, 2000, are Copyright (c) 1998, 1999 Glenn Randers-Pehrson, and are distributed according to the same disclaimer and license as libpng-0.96, with the following individuals added to the list of Contributing Authors:

Tom Lane  
Glenn Randers-Pehrson  
Willem van Schaik

libpng versions 0.89, June 1996, through 0.96, May 1997, are Copyright (c) 1996, 1997 Andreas Digger  
Distributed according to the same disclaimer and license as libpng-0.88, with the following individuals added to the list of Contributing Authors:

John Bowler  
Kevin Bracey  
Sam Bushell  
Magnus Holmgren  
Greg Roelofs  
Tom Tanner

libpng versions 0.5, May 1995, through 0.88, January 1996, are  
Copyright (c) 1995, 1996 Guy Eric Schalnat, Group 42, Inc.

For the purposes of this copyright and license, "Contributing Authors" is defined as the following set of individuals:

Andreas Dilger  
Dave Martindale  
Guy Eric Schalnat  
Paul Schmidt  
Tim Wegner

The PNG Reference Library is supplied "AS IS". The Contributing Authors and Group 42, Inc. disclaim all warranties, expressed or implied, including, without limitation, the warranties of merchantability and of fitness for any purpose. The Contributing Authors and Group 42, Inc. assume no liability for direct, indirect, incidental, special, exemplary, or consequential damages, which may result from the use of the PNG Reference Library, even if advised of the possibility of such damage.

Permission is hereby granted to use, copy, modify, and distribute this source code, or portions hereof, for any purpose, without fee, subject to the following restrictions:

1. The origin of this source code must not be misrepresented.
2. Altered versions must be plainly marked as such and must not be misrepresented as being the original source.
3. This Copyright notice may not be removed or altered from any source or altered source distribution.

The Contributing Authors and Group 42, Inc. specifically permit, without fee, and encourage the use of this source code as a component to supporting the PNG file format in commercial products. If you use this source code in a product, acknowledgment is not required but would be appreciated.

A "png\_get\_copyright" function is available, for convenient use in "about" boxes and the like:

```
printf("%s",png_get_copyright(NULL));
```

Also, the PNG logo (in PNG format, of course) is supplied in the files "pngbar.png" and "nngbar.ing (88x31) and "nngnow.png" (98x31)

png2jpg (2001) and png2mipng (2001).

Libpng is OSI Certified Open Source Software. OSI Certified Open Source is a certification mark of the Open Source Initiative.

Glenn Randers-Pehrson  
glennrp at users.sourceforge.net  
December 9, 2010

---

## MIT

Permission is hereby granted, free of charge, to any person obtaining a copy of this software and associated documentation files (the "Software"), to deal in the Software without restriction, including without limitation the rights to use, copy, modify, merge, publish, distribute, sublicense, and/or sell copies of the Software, and to permit persons to whom the Software is furnished to do so, subject to the following conditions:

The above copyright notice and this permission notice shall be included in all copies or substantial portions of the Software.

THE SOFTWARE IS PROVIDED "AS IS", WITHOUT WARRANTY OF ANY KIND, EXPRESS OR IMPLIED, INCLUDING BUT NOT LIMITED TO THE WARRANTIES OF MERCHANTABILITY, FITNESS FOR A PARTICULAR PURPOSE AND NONINFRINGEMENT. IN NO EVENT SHALL THE AUTHORS OR COPYRIGHT HOLDERS BE LIABLE FOR ANY CLAIM, DAMAGES OR OTHER LIABILITY, WHETHER IN AN ACTION OF CONTRACT, TORT OR OTHERWISE, ARISING FROM, OUT OF OR IN CONNECTION WITH THE SOFTWARE OR THE USE OR OTHER DEALINGS IN THE SOFTWARE.

---

## MIT-like License (HarfBuzz)

HarfBuzz is licensed under the so-called "Old MIT" license. Details follow.  
For parts of HarfBuzz that are licensed under different licenses see individual files names COPYING in subdirectories where applicable.

Copyright (c) 2010,2011,2012 Google, Inc.  
Copyright (c) 2012 Mozilla Foundation



Copyright (c) 2011 Codethink Limited  
Copyright (c) 2008,2010 Nokia Corporation and/or its subsidiary(-ies)  
Copyright (c) 2009 Keith Stribley  
Copyright (c) 2009 Martin Hosken and SIL International  
Copyright (c) 2007 Chris Wilson  
Copyright (c) 2006 Behdad Esfahbod  
Copyright (c) 2005 David Turner  
Copyright (c) 2004,2007,2008,2009,2010 Red Hat, Inc.  
Copyright (c) 1998-2004 David Turner and Werner Lemberg

For full copyright notices consult the individual files in the package.

Permission is hereby granted, without written agreement and without license or royalty fees, to use, copy, modify, and distribute this software and its documentation for any purpose, provided that the above copyright notice and the following two paragraphs appear in all copies of this software.

IN NO EVENT SHALL THE COPYRIGHT HOLDER BE LIABLE TO ANY PARTY FOR DIRECT, INDIRECT, SPECIAL, INCIDENTAL, OR CONSEQUENTIAL DAMAGES ARISING OUT OF THE USE OF THIS SOFTWARE AND ITS DOCUMENTATION, EVEN IF THE COPYRIGHT HOLDER HAS BEEN ADVISED OF THE POSSIBILITY OF SUCH DAMAGE.

THE COPYRIGHT HOLDER SPECIFICALLY DISCLAIMS ANY WARRANTIES, INCLUDING, BUT NOT LIMITED TO, THE IMPLIED WARRANTIES OF MERCHANTABILITY AND FITNESS FOR A PARTICULAR PURPOSE. THE SOFTWARE PROVIDED HEREUNDER IS ON AN "AS IS" BASIS, AND THE COPYRIGHT HOLDER HAS NO OBLIGATION TO PROVIDE MAINTENANCE, SUPPORT, UPDATES, ENHANCEMENTS, OR MODIFICATIONS.

---

## **MIT-like License (font-xfree86-type1)**

Permission is hereby granted, free of charge, to any person obtaining a copy of this software and associated documentation files (the "Software"), to deal in the Software without restriction, including without limitation the rights to use, copy, modify, merge, publish, distribute, sublicense, and/or sell copies of the Software, and to permit persons to whom the Software is furnished to do so, subject to the following conditions:

The above copyright notice and this permission notice shall be included in all copies or substantial portions of the Software.

THE SOFTWARE IS PROVIDED "AS IS", WITHOUT WARRANTY OF ANY KIND, EXPRESS OR IMPLIED, INCLUDING BUT NOT LIMITED TO THE WARRANTIES OF MERCHANTABILITY, FITNESS FOR A PARTICULAR PURPOSE AND NONINFRINGEMENT. IN NO EVENT SHALL THE XFREE86 PROJECT BE LIABLE FOR ANY CLAIM, DAMAGES OR OTHER LIABILITY, WHETHER IN AN ACTION OF CONTRACT, TORT OR OTHERWISE, ARISING FROM, OUT OF OR IN CONNECTION WITH THE SOFTWARE OR THE USE OR OTHER DEALINGS IN THE SOFTWARE.

Except as contained in this notice, the name of the XFree86 Project shall not be used in advertising or otherwise to promote the sale, use or other dealings in this Software without prior written authorization from the XFree86 Project.

---

## **MIT-like License (fontconfig)**

Permission to use, copy, modify, distribute, and sell this software and its documentation for any purpose is hereby granted without fee, provided that the above copyright notice appear in all copies and that both that copyright notice and this permission notice appear in supporting documentation, and that the name of the author(s) not be used in advertising or publicity pertaining to distribution of the software without specific, written prior permission. The authors make no representations about the suitability of this software for any purpose. It is provided "as is" without express or implied warranty.

THE AUTHOR(S) DISCLAIMS ALL WARRANTIES WITH REGARD TO THIS SOFTWARE, INCLUDING ALL IMPLIED WARRANTIES OF MERCHANTABILITY AND FITNESS, IN NO EVENT SHALL THE AUTHOR(S) BE LIABLE FOR ANY SPECIAL, INDIRECT OR CONSEQUENTIAL DAMAGES OR ANY DAMAGES WHATSOEVER RESULTING FROM LOSS OF USE, DATA OR PROFITS, WHETHER IN AN ACTION OF CONTRACT, NEGLIGENCE OR OTHER TORTIOUS ACTION, ARISING OUT OF OR IN CONNECTION WITH THE USE OR PERFORMANCE OF THIS SOFTWARE.

---

## **MIT-like License (libXcursor)**

Permission to use, copy, modify, distribute, and sell this software and its documentation for any purpose is hereby granted without fee, provided that the above copyright notice appear in all copies and that both that copyright notice and this permission notice appear in supporting documentation, and that the name of Keith Packard not be used in advertising or publicity pertaining to distribution of the software without specific, written prior permission. Keith Packard makes no representations about the suitability of this software for any purpose. It is provided "as is" without express or implied warranty.

KEITH PACKARD DISCLAIMS ALL WARRANTIES WITH REGARD TO THIS SOFTWARE, INCLUDING ALL IMPLIED WARRANTIES OF MERCHANTABILITY AND FITNESS, IN NO EVENT SHALL KEITH PACKARD BE LIABLE FOR ANY SPECIAL, INDIRECT OR CONSEQUENTIAL DAMAGES OR ANY DAMAGES WHATSOEVER RESULTING FROM LOSS OF USE, DATA OR PROFITS, WHETHER IN AN ACTION OF CONTRACT, NEGLIGENCE OR OTHER TORTIOUS ACTION, ARISING OUT OF OR IN CONNECTION WITH THE USE OR PERFORMANCE OF THIS SOFTWARE.

---

## **MIT-like License (libXmu)**

Copyright 1988, 1989, 1990, 1991, 1994, 1998 The Open Group

Permission to use, copy, modify, distribute, and sell this software and its documentation for any purpose is hereby granted without fee, provided that the above copyright notice appear in all copies and that both that copyright notice and this permission notice appear in supporting documentation.

The above copyright notice and this permission notice shall be included in all copies or substantial portions of the Software.

THE SOFTWARE IS PROVIDED "AS IS", WITHOUT WARRANTY OF ANY KIND, EXPRESS OR IMPLIED, INCLUDING BUT NOT LIMITED TO THE WARRANTIES OF MERCHANTABILITY, FITNESS FOR A PARTICULAR PURPOSE AND NONINFRINGEMENT. IN NO EVENT SHALL THE OPEN GROUP BE LIABLE FOR ANY CLAIM, DAMAGES OR OTHER LIABILITY, WHETHER IN AN ACTION OF CONTRACT, TORT OR OTHERWISE, ARISING FROM, OUT OF OR IN CONNECTION WITH THE SOFTWARE OR THE USE OR OTHER DEALINGS IN THE SOFTWARE.

Except as contained in this notice, the name of The Open Group shall not be used in advertising or otherwise to promote the sale, use or other dealings in this Software without prior written authorization from The Open Group.

-----  
Xmu/StrToBmap.c and Xmu/GrayPixmap.c also have:

Copyright 1987, 1988 by Digital Equipment Corporation, Maynard, Massachusetts.

All Rights Reserved

Permission to use, copy, modify, and distribute this software and its documentation for any purpose and without fee is hereby granted, provided that the above copyright notice appear in all copies and that both that copyright notice and this permission notice appear in supporting documentation, and that the name of Digital not be used in advertising or publicity pertaining to distribution of the software without specific, written prior permission.

DIGITAL DISCLAIMS ALL WARRANTIES WITH REGARD TO THIS SOFTWARE, INCLUDING ALL IMPLIED WARRANTIES OF MERCHANTABILITY AND FITNESS, IN NO EVENT SHALL DIGITAL BE LIABLE FOR ANY SPECIAL, INDIRECT OR CONSEQUENTIAL DAMAGES OR ANY DAMAGES WHATSOEVER RESULTING FROM LOSS OF USE, DATA OR PROFITS, WHETHER IN AN ACTION OF CONTRACT, NEGLIGENCE OR OTHER TORTIOUS ACTION, ARISING OUT OF OR IN CONNECTION WITH THE USE OR PERFORMANCE OF THIS SOFTWARE.

-----  
Xmu/Clip.c and Xmu/Lookup.h have:

Copyright (c) 1998 by The XFree86 Project, Inc.

Copyright 1999 by Thomas E. Dickey <dickey@clark.net>

Permission is hereby granted, free of charge, to any person obtaining a copy of this software and associated documentation files (the "Software"), to deal in the Software without restriction, including without limitation the rights to use, copy, modify, merge, publish, distribute, sublicense, and/or sell copies of the Software, and to permit persons to whom the Software is furnished to do so, subject to the following conditions:

The above copyright notice and this permission notice shall be included in

The above copyright notice and this permission notice shall be included in all copies or substantial portions of the Software.

THE SOFTWARE IS PROVIDED "AS IS", WITHOUT WARRANTY OF ANY KIND, EXPRESS OR IMPLIED, INCLUDING BUT NOT LIMITED TO THE WARRANTIES OF MERCHANTABILITY, FITNESS FOR A PARTICULAR PURPOSE AND NONINFRINGEMENT. IN NO EVENT SHALL THE XFREE86 PROJECT BE LIABLE FOR ANY CLAIM, DAMAGES OR OTHER LIABILITY, WHETHER IN AN ACTION OF CONTRACT, TORT OR OTHERWISE, ARISING FROM, OUT OF OR IN CONNECTION WITH THE SOFTWARE OR THE USE OR OTHER DEALINGS IN THE SOFTWARE.

Except as contained in this notice, the name of the XFree86 Project shall not be used in advertising or otherwise to promote the sale, use or other dealings in this Software without prior written authorization from the XFree86 Project.

---

## **MIT-like License (ncurses)**

Copyright (c) 1999-2004,2005 Free Software Foundation, Inc.

Permission is hereby granted, free of charge, to any person obtaining a copy of this software and associated documentation files (the "Software"), to deal in the Software without restriction, including without limitation the rights to use, copy, modify, merge, publish, distribute, distribute with modifications, sublicense, and/or sell copies of the Software, and to permit persons to whom the Software is furnished to do so, subject to the following conditions:

The above copyright notice and this permission notice shall be included in all copies or substantial portions of the Software.

THE SOFTWARE IS PROVIDED "AS IS", WITHOUT WARRANTY OF ANY KIND, EXPRESS OR IMPLIED, INCLUDING BUT NOT LIMITED TO THE WARRANTIES OF MERCHANTABILITY, FITNESS FOR A PARTICULAR PURPOSE AND NONINFRINGEMENT. IN NO EVENT SHALL THE ABOVE COPYRIGHT HOLDERS BE LIABLE FOR ANY CLAIM, DAMAGES OR OTHER LIABILITY, WHETHER IN AN ACTION OF CONTRACT, TORT OR OTHERWISE, ARISING FROM, OUT OF OR IN CONNECTION WITH THE SOFTWARE OR THE USE OR OTHER DEALINGS IN THE SOFTWARE.

Except as contained in this notice, the name(s) of the above copyright holders shall not be

used in advertising or otherwise to promote the sale, use or other dealings in this Software without prior written authorization.

---

## MIT-like License (sudo)

Sudo is distributed under the following license:

Copyright (c) 1994-1996, 1998-2013  
Todd C. Miller <Todd.Miller@courtesan.com>

Permission to use, copy, modify, and distribute this software for any purpose with or without fee is hereby granted, provided that the above copyright notice and this permission notice appear in all copies.

THE SOFTWARE IS PROVIDED "AS IS" AND THE AUTHOR DISCLAIMS ALL WARRANTIES WITH REGARD TO THIS SOFTWARE INCLUDING ALL IMPLIED WARRANTIES OF MERCHANTABILITY AND FITNESS. IN NO EVENT SHALL THE AUTHOR BE LIABLE FOR ANY SPECIAL, DIRECT, INDIRECT, OR CONSEQUENTIAL DAMAGES OR ANY DAMAGES WHATSOEVER RESULTING FROM LOSS OF USE, DATA OR PROFITS, WHETHER IN AN ACTION OF CONTRACT, NEGLIGENCE OR OTHER TORTIOUS ACTION, ARISING OUT OF OR IN CONNECTION WITH THE USE OR PERFORMANCE OF THIS SOFTWARE.

Sponsored in part by the Defense Advanced Research Projects Agency (DARPA) and Air Force Research Laboratory, Air Force Materiel Command, USAF, under agreement number F39502-99-1-0512.

The file redblack.c bears the following license:

Copyright (c) 2001 Emin Martinian

Redistribution and use in source and binary forms, with or without modification, are permitted provided that neither the name of Emin Martinian nor the names of any contributors are be used to endorse or promote products derived from this software without specific prior written permission.

THIS SOFTWARE IS PROVIDED BY THE COPYRIGHT HOLDERS AND CONTRIBUTORS "AS IS" AND ANY EXPRESS OR IMPLIED WARRANTIES, INCLUDING, BUT NOT LIMITED TO, THE IMPLIED WARRANTIES OF MERCHANTABILITY AND FITNESS FOR

LIMITED TO, THE IMPLIED WARRANTIES OF MERCHANTABILITY AND FITNESS FOR A PARTICULAR PURPOSE ARE DISCLAIMED. IN NO EVENT SHALL THE COPYRIGHT OWNER OR CONTRIBUTORS BE LIABLE FOR ANY DIRECT, INDIRECT, INCIDENTAL, SPECIAL, EXEMPLARY, OR CONSEQUENTIAL DAMAGES (INCLUDING, BUT NOT LIMITED TO, PROCUREMENT OF SUBSTITUTE GOODS OR SERVICES; LOSS OF USE, DATA, OR PROFITS; OR BUSINESS INTERRUPTION) HOWEVER CAUSED AND ON ANY THEORY OF LIABILITY, WHETHER IN CONTRACT, STRICT LIABILITY, OR TORT (INCLUDING NEGLIGENCE OR OTHERWISE) ARISING IN ANY WAY OUT OF THE USE OF THIS SOFTWARE, EVEN IF ADVISED OF THE POSSIBILITY OF SUCH DAMAGE.

The files `getcwd.c`, `glob.c`, `glob.h` and `snprintf.c` bear the following license:

Copyright (c) 1989, 1990, 1991, 1993

The Regents of the University of California. All rights reserved.

Redistribution and use in source and binary forms, with or without modification, are permitted provided that the following conditions are met:

1. Redistributions of source code must retain the above copyright notice, this list of conditions and the following disclaimer.
2. Redistributions in binary form must reproduce the above copyright notice, this list of conditions and the following disclaimer in the documentation and/or other materials provided with the distribution.
3. Neither the name of the University nor the names of its contributors may be used to endorse or promote products derived from this software without specific prior written permission.

THIS SOFTWARE IS PROVIDED BY THE REGENTS AND CONTRIBUTORS ``AS IS'' AND ANY EXPRESS OR IMPLIED WARRANTIES, INCLUDING, BUT NOT LIMITED TO, THE IMPLIED WARRANTIES OF MERCHANTABILITY AND FITNESS FOR A PARTICULAR PURPOSE ARE DISCLAIMED. IN NO EVENT SHALL THE REGENTS OR CONTRIBUTORS BE LIABLE FOR ANY DIRECT, INDIRECT, INCIDENTAL, SPECIAL, EXEMPLARY, OR CONSEQUENTIAL DAMAGES (INCLUDING, BUT NOT LIMITED TO, PROCUREMENT OF SUBSTITUTE GOODS OR SERVICES; LOSS OF USE, DATA, OR PROFITS; OR BUSINESS INTERRUPTION) HOWEVER CAUSED AND ON ANY THEORY OF LIABILITY, WHETHER IN CONTRACT, STRICT LIABILITY, OR TORT (INCLUDING NEGLIGENCE OR OTHERWISE) ARISING IN ANY WAY OUT OF THE USE OF THIS SOFTWARE, EVEN IF ADVISED OF THE POSSIBILITY OF SUCH DAMAGE.

The file `fnmatch.c` bears the following license:

Copyright (c) 2011, VMware, Inc.

All rights reserved.

Redistribution and use in source and binary forms, with or without modification, are permitted provided that the following conditions are met:

- \* Redistributions of source code must retain the above copyright notice, this list of conditions and the following disclaimer.
- \* Redistributions in binary form must reproduce the above copyright notice, this list of conditions and the following disclaimer in the documentation and/or other materials provided with the distribution.
- \* Neither the name of the VMware, Inc. nor the names of its contributors may be used to endorse or promote products derived from this software without specific prior written permission.

THIS SOFTWARE IS PROVIDED BY THE COPYRIGHT HOLDERS AND CONTRIBUTORS "AS IS" AND ANY EXPRESS OR IMPLIED WARRANTIES, INCLUDING, BUT NOT LIMITED TO, THE IMPLIED WARRANTIES OF MERCHANTABILITY AND FITNESS FOR A PARTICULAR PURPOSE ARE DISCLAIMED. IN NO EVENT SHALL VMWARE, INC. OR CONTRIBUTORS BE LIABLE FOR ANY DIRECT, INDIRECT, INCIDENTAL, SPECIAL, EXEMPLARY, OR CONSEQUENTIAL DAMAGES (INCLUDING, BUT NOT LIMITED TO, PROCUREMENT OF SUBSTITUTE GOODS OR SERVICES; LOSS OF USE, DATA, OR PROFITS; OR BUSINESS INTERRUPTION) HOWEVER CAUSED AND ON ANY THEORY OF LIABILITY, WHETHER IN CONTRACT, STRICT LIABILITY, OR TORT (INCLUDING NEGLIGENCE OR OTHERWISE) ARISING IN ANY WAY OUT OF THE USE OF THIS SOFTWARE, EVEN IF ADVISED OF THE POSSIBILITY OF SUCH DAMAGE.

The embedded copy of zlib bears the following license:

Copyright (C) 1995-2012 Jean-loup Gailly and Mark Adler

This software is provided 'as-is', without any express or implied warranty. In no event will the authors be held liable for any damages arising from the use of this software.

Permission is granted to anyone to use this software for any purpose, including commercial applications, and to alter it and redistribute it freely, subject to the following restrictions:

1. The origin of this software must not be misrepresented; you must not claim that you wrote the original software. If you use this software in a product, an acknowledgment in the product documentation would be appreciated but is not required.
2. Altered source versions must be plainly marked as such, and must not be misrepresented as being the original software.
3. This notice may not be removed or altered from any source distribution.

Jean-loup Gailly Mark Adler  
jloup@gzip.org madler@alumni.caltech.edu

---

## MIT-like License (xcb-util)

Permission is hereby granted, free of charge, to any person obtaining a copy of this software and associated documentation files (the "Software"), to deal in the Software without restriction, including without limitation the rights to use, copy, modify, merge, publish, distribute, sublicense, and/or sell copies of the Software, and to permit persons to whom the Software is furnished to do so, subject to the following conditions

The above copyright notice and this permission notice shall be included in all copies or substantial portions of the Software.

THE SOFTWARE IS PROVIDED "AS IS", WITHOUT WARRANTY OF ANY KIND, EXPRESS OR IMPLIED, INCLUDING BUT NOT LIMITED TO THE WARRANTIES OF MERCHANTABILITY, FITNESS FOR A PARTICULAR PURPOSE AND NONINFRINGEMENT. IN NO EVENT SHALL THE AUTHORS BE LIABLE FOR ANY CLAIM, DAMAGES OR OTHER LIABILITY, WHETHER IN AN ACTION OF CONTRACT, TORT OR OTHERWISE, ARISING FROM, OUT OF OR IN CONNECTION WITH THE SOFTWARE OR THE USE OR OTHER DEALINGS IN THE SOFTWARE.

Except as contained in this notice, the names of the authors or their institutions shall not be used in advertising or otherwise to promote the sale, use or other dealings in this Software without prior written authorization from the authors.

---

## MIT-like License (xkbcomp)

Copyright (c) 1994 by Silicon Graphics Computer Systems, Inc.

Permission to use, copy, modify, and distribute this software and its documentation for any purpose and without fee is hereby granted, provided that the above copyright notice appear in all copies and that both that copyright notice and this permission notice appear in supporting

documentation, and that the name of Silicon Graphics not be used in advertising or publicity pertaining to distribution of the software without specific prior written permission. Silicon Graphics makes no representation about the suitability of this software for any purpose. It is provided "as is" without any express or implied warranty.

SILICON GRAPHICS DISCLAIMS ALL WARRANTIES WITH REGARD TO THIS SOFTWARE, INCLUDING ALL IMPLIED WARRANTIES OF MERCHANTABILITY AND FITNESS FOR A PARTICULAR PURPOSE. IN NO EVENT SHALL SILICON GRAPHICS BE LIABLE FOR ANY SPECIAL, INDIRECT OR CONSEQUENTIAL DAMAGES OR ANY DAMAGES WHATSOEVER RESULTING FROM LOSS OF USE, DATA OR PROFITS, WHETHER IN AN ACTION OF CONTRACT, NEGLIGENCE OR OTHER TORTIOUS ACTION, ARISING OUT OF OR IN CONNECTION WITH THE USE OR PERFORMANCE OF THIS SOFTWARE.

Copyright 1988, 1998 The Open Group

Permission to use, copy, modify, distribute, and sell this software and its documentation for any purpose is hereby granted without fee, provided that the above copyright notice appear in all copies and that both that copyright notice and this permission notice appear in supporting documentation.

The above copyright notice and this permission notice shall be included in all copies or substantial portions of the Software.

THE SOFTWARE IS PROVIDED "AS IS", WITHOUT WARRANTY OF ANY KIND, EXPRESS OR IMPLIED, INCLUDING BUT NOT LIMITED TO THE WARRANTIES OF MERCHANTABILITY, FITNESS FOR A PARTICULAR PURPOSE AND NONINFRINGEMENT. IN NO EVENT SHALL THE OPEN GROUP BE LIABLE FOR ANY CLAIM, DAMAGES OR OTHER LIABILITY, WHETHER IN AN ACTION OF CONTRACT, TORT OR OTHERWISE, ARISING FROM, OUT OF OR IN CONNECTION WITH THE SOFTWARE OR THE USE OR OTHER DEALINGS IN THE SOFTWARE.

Except as contained in this notice, the name of The Open Group shall not be used in advertising or otherwise to promote the sale, use or other dealings in this Software without prior written authorization from The Open Group.

Copyright 1988 by Digital Equipment Corporation, Maynard, Massachusetts.

All Rights Reserved

Permission to use, copy, modify, and distribute this software and its documentation for any purpose and without fee is hereby granted, provided that the above copyright notice appear in all copies and that both that copyright notice and this permission notice appear in supporting documentation, and that the name of Digital not be used in advertising or publicity pertaining to distribution of the software without specific, written prior permission.

DIGITAL DISCLAIMS ALL WARRANTIES WITH REGARD TO THIS SOFTWARE, INCLUDING ALL IMPLIED WARRANTIES OF MERCHANTABILITY AND FITNESS, IN NO EVENT SHALL DIGITAL BE LIABLE FOR ANY SPECIAL, INDIRECT OR CONSEQUENTIAL DAMAGES OR ANY DAMAGES WHATSOEVER RESULTING FROM LOSS OF USE, DATA OR PROFITS, WHETHER IN AN ACTION OF CONTRACT, NEGLIGENCE OR OTHER TORTIOUS ACTION, ARISING OUT OF OR IN CONNECTION WITH THE USE OR PERFORMANCE OF THIS SOFTWARE.

COPYRIGHT 1990  
DIGITAL EQUIPMENT CORPORATION  
MAYNARD, MASSACHUSETTS  
ALL RIGHTS RESERVED.

THE INFORMATION IN THIS SOFTWARE IS SUBJECT TO CHANGE WITHOUT NOTICE AND SHOULD NOT BE CONSTRUED AS A COMMITMENT BY DIGITAL EQUIPMENT CORPORATION. DIGITAL MAKES NO REPRESENTATIONS ABOUT THE SUITABILITY OF THIS SOFTWARE FOR ANY PURPOSE. IT IS SUPPLIED "AS IS" WITHOUT EXPRESS OR IMPLIED WARRANTY.

IF THE SOFTWARE IS MODIFIED IN A MANNER CREATING DERIVATIVE COPYRIGHT RIGHTS, APPROPRIATE LEGENDS MAY BE PLACED ON THE DERIVATIVE WORK IN ADDITION TO THAT SET FORTH ABOVE.

Permission to use, copy, modify, and distribute this software and its documentation for any purpose and without fee is hereby granted, provided that the above copyright notice appear in all copies and that both that copyright notice and this permission notice appear in supporting documentation, and that the name of Digital Equipment Corporation not be used in advertising or publicity pertaining to distribution of the software without specific, written prior permission.

## MIT-like License (xserver)

The following is the 'standard copyright' agreed upon by most contributors, and is currently the canonical license preferred by the X.Org Foundation. This is a slight variant of the common MIT license form published by the Open Source Initiative at <http://www.opensource.org/licenses/mit-license.php>

Copyright holders of new code should use this license statement where possible, and insert their name to this list. Please sort by surname for people, and by the full name for other entities (e.g. Juliusz Chroboczek sorts before Intel Corporation sorts before Daniel Stone).

Copyright (c) 2011 Dave Airlie

Copyright (c) 2000-2001 Juliusz Chroboczek

Copyright (c) 1998 Egbert Eich

Copyright (c) 2006-2007 Intel Corporation

Copyright (c) 2006 Nokia Corporation

Copyright (c) 2006-2008 Peter Hutterer

Copyright (c) 2006 Adam Jackson

Copyright (c) 2009-2010 NVIDIA Corporation

Copyright (c) 1987, 2003-2006, 2008-2010 Oracle and/or its affiliates.

Copyright (c) 1999 Keith Packard

Copyright (c) 2007-2009 Red Hat, Inc.

Copyright (c) 2005-2008 Daniel Stone

Copyright (c) 2006-2009 Simon Thum

Copyright (c) 2003-2008, 2013 Geert Uytterhoeven

Copyright (c) 2006 Luc Verhaegen

Permission is hereby granted, free of charge, to any person obtaining a copy of this software and associated documentation files (the "Software"), to deal in the Software without restriction, including without limitation the rights to use, copy, modify, merge, publish, distribute, sublicense, and/or sell copies of the Software, and to permit persons to whom the Software is furnished to do so, subject to the following conditions:

The above copyright notice and this permission notice (including the next paragraph) shall be included in all copies or substantial portions of the Software.

THE SOFTWARE IS PROVIDED "AS IS", WITHOUT WARRANTY OF ANY KIND, EXPRESS OR IMPLIED, INCLUDING BUT NOT LIMITED TO THE WARRANTIES OF MERCHANTABILITY, FITNESS FOR A PARTICULAR PURPOSE AND NONINFRINGEMENT. IN NO EVENT SHALL THE AUTHORS OR COPYRIGHT HOLDERS BE LIABLE FOR ANY CLAIM, DAMAGES OR OTHER

LIABILITY, WHETHER IN AN ACTION OF CONTRACT, TORT OR OTHERWISE, ARISING FROM, OUT OF OR IN CONNECTION WITH THE SOFTWARE OR THE USE OR OTHER DEALINGS IN THE SOFTWARE.

The following licenses are 'legacy': usually MIT/X11 licenses with the name of the copyright holder(s) in the license statement, but also some BSD-like licenses.

Copyright (c) 1994-2003 The XFree86 Project, Inc. All Rights Reserved.

Copyright (c) Colin Harrison 2005-2008

Copyright (c) 2005 Bogdan D. bogdand@users.sourceforge.net

Permission is hereby granted, free of charge, to any person obtaining a copy of this software and associated documentation files (the "Software"), to deal in the Software without restriction, including without limitation the rights to use, copy, modify, merge, publish, distribute, sublicense, and/or sell copies of the Software, and to permit persons to whom the Software is furnished to do so, subject to the following conditions:

The above copyright notice and this permission notice shall be included in all copies or substantial portions of the Software.

THE SOFTWARE IS PROVIDED "AS IS", WITHOUT WARRANTY OF ANY KIND, EXPRESS OR IMPLIED, INCLUDING BUT NOT LIMITED TO THE WARRANTIES OF MERCHANTABILITY, FITNESS FOR A PARTICULAR PURPOSE AND NONINFRINGEMENT. IN NO EVENT SHALL THE AUTHOR BE LIABLE FOR ANY CLAIM, DAMAGES OR OTHER LIABILITY, WHETHER IN AN ACTION OF CONTRACT, TORT OR OTHERWISE, ARISING FROM, OUT OF OR IN CONNECTION WITH THE SOFTWARE OR THE USE OR OTHER DEALINGS IN THE SOFTWARE.

Except as contained in this notice, the name of the author shall not be used in advertising or otherwise to promote the sale, use or other dealings in this Software without prior written authorization from the author.

Copyright 1997 by The XFree86 Project, Inc.

Permission to use, copy, modify, distribute, and sell this software and its documentation for any purpose is hereby granted without fee, provided that the above copyright notice appear in all copies and that both that

the above copyright notice appear in all copies and that both that copyright notice and this permission notice appear in supporting documentation, and that the name of the XFree86 Project, Inc. not be used in advertising or publicity pertaining to distribution of the software without specific, written prior permission. The Xfree86 Project, Inc. makes no representations about the suitability of this software for any purpose. It is provided "as is" without express or implied warranty.

THE XFREE86 PROJECT, INC. DISCLAIMS ALL WARRANTIES WITH REGARD TO THIS SOFTWARE, INCLUDING ALL IMPLIED WARRANTIES OF MERCHANTABILITY AND FITNESS, IN NO EVENT SHALL OREST ZBOROWSKI OR DAVID WEXELBLAT BE LIABLE FOR ANY SPECIAL, INDIRECT OR CONSEQUENTIAL DAMAGES OR ANY DAMAGES WHATSOEVER RESULTING FROM LOSS OF USE, DATA OR PROFITS, WHETHER IN AN ACTION OF CONTRACT, NEGLIGENCE OR OTHER TORTIOUS ACTION, ARISING OUT OF OR IN CONNECTION WITH THE USE OR PERFORMANCE OF THIS SOFTWARE.

Copyright 1985-1998, 2001 The Open Group  
Copyright 2002 Red Hat Inc., Durham, North Carolina.

Permission to use, copy, modify, distribute, and sell this software and its documentation for any purpose is hereby granted without fee, provided that the above copyright notice appear in all copies and that both that copyright notice and this permission notice appear in supporting documentation.

The above copyright notice and this permission notice shall be included in all copies or substantial portions of the Software.

THE SOFTWARE IS PROVIDED "AS IS", WITHOUT WARRANTY OF ANY KIND, EXPRESS OR IMPLIED, INCLUDING BUT NOT LIMITED TO THE WARRANTIES OF MERCHANTABILITY, FITNESS FOR A PARTICULAR PURPOSE AND NONINFRINGEMENT. IN NO EVENT SHALL THE OPEN GROUP BE LIABLE FOR ANY CLAIM, DAMAGES OR OTHER LIABILITY, WHETHER IN AN ACTION OF CONTRACT, TORT OR OTHERWISE, ARISING FROM, OUT OF OR IN CONNECTION WITH THE SOFTWARE OR THE USE OR OTHER DEALINGS IN THE SOFTWARE.

Except as contained in this notice, the name of The Open Group shall not be used in advertising or otherwise to promote the sale, use or other dealings in this Software without prior written authorization from The Open Group.

Copyright (c) 1987, 1989-1990, 1992-1995 X Consortium

Permission is hereby granted, free of charge, to any person obtaining a copy of this software and associated documentation files (the "Software"), to deal in the Software without restriction, including without limitation the rights to use, copy, modify, merge, publish, distribute, sublicense, and/or sell copies of the Software, and to permit persons to whom the Software is furnished to do so, subject to the following conditions:

The above copyright notice and this permission notice shall be included in all copies or substantial portions of the Software.

THE SOFTWARE IS PROVIDED "AS IS", WITHOUT WARRANTY OF ANY KIND, EXPRESS OR IMPLIED, INCLUDING BUT NOT LIMITED TO THE WARRANTIES OF MERCHANTABILITY, FITNESS FOR A PARTICULAR PURPOSE AND NONINFRINGEMENT. IN NO EVENT SHALL THE X CONSORTIUM BE LIABLE FOR ANY CLAIM, DAMAGES OR OTHER LIABILITY, WHETHER IN AN ACTION OF CONTRACT, TORT OR OTHERWISE, ARISING FROM, OUT OF OR IN CONNECTION WITH THE SOFTWARE OR THE USE OR OTHER DEALINGS IN THE SOFTWARE.

Except as contained in this notice, the name of the X Consortium shall not be used in advertising or otherwise to promote the sale, use or other dealings in this Software without prior written authorization from the X Consortium.

Copyright 2008 Tungsten Graphics, Inc., Cedar Park, Texas.

Permission is hereby granted, free of charge, to any person obtaining a copy of this software and associated documentation files (the "Software"), to deal in the Software without restriction, including without limitation the rights to use, copy, modify, merge, publish, distribute, sub license, and/or sell copies of the Software, and to permit persons to whom the Software is furnished to do so, subject to the following conditions:

The above copyright notice and this permission notice (including the next paragraph) shall be included in all copies or substantial portions of the Software.

THE SOFTWARE IS PROVIDED "AS IS", WITHOUT WARRANTY OF ANY KIND, EXPRESS OR IMPLIED, INCLUDING BUT NOT LIMITED TO THE WARRANTIES OF MERCHANTABILITY, FITNESS FOR A PARTICULAR PURPOSE AND NON-INFRINGEMENT. IN NO EVENT SHALL TUNGSTEN GRAPHICS AND/OR ITS SUPPLIERS BE LIABLE FOR ANY CLAIM, DAMAGES OR OTHER LIABILITY, WHETHER IN AN ACTION OF CONTRACT, TORT OR OTHERWISE, ARISING FROM, OUT OF OR IN CONNECTION WITH THE SOFTWARE OR THE USE OR OTHER DEALINGS IN THE SOFTWARE.

Copyright (c) 1999-2000 SuSE, Inc.

Copyright (c) 2007 Red Hat, Inc.

Permission to use, copy, modify, distribute, and sell this software and its documentation for any purpose is hereby granted without fee, provided that the above copyright notice appear in all copies and that both that copyright notice and this permission notice appear in supporting documentation, and that the name of SuSE not be used in advertising or publicity pertaining to distribution of the software without specific, written prior permission. SuSE makes no representations about the suitability of this software for any purpose. It is provided "as is" without express or implied warranty.

SUSE DISCLAIMS ALL WARRANTIES WITH REGARD TO THIS SOFTWARE, INCLUDING ALL IMPLIED WARRANTIES OF MERCHANTABILITY AND FITNESS, IN NO EVENT SHALL SUSE BE LIABLE FOR ANY SPECIAL, INDIRECT OR CONSEQUENTIAL DAMAGES OR ANY DAMAGES WHATSOEVER RESULTING FROM LOSS OF USE, DATA OR PROFITS, WHETHER IN AN ACTION OF CONTRACT, NEGLIGENCE OR OTHER TORTIOUS ACTION, ARISING OUT OF OR IN CONNECTION WITH THE USE OR PERFORMANCE OF THIS SOFTWARE.

Copyright 1987-1991, 1993 by Digital Equipment Corporation, Maynard, Massachusetts.

Copyright 1991 Massachusetts Institute of Technology, Cambridge, Massachusetts.

Copyright 1991, 1993 Olivetti Research Limited, Cambridge, England.

All Rights Reserved

Permission to use, copy, modify, and distribute this software and its documentation for any purpose and without fee is hereby granted, provided that the above copyright notice appear in all copies and that both that copyright notice and this permission notice appear in supporting documentation, and that the name of Digital not be used in advertising or publicity pertaining to distribution of the software without specific, written prior permission.

DIGITAL DISCLAIMS ALL WARRANTIES WITH REGARD TO THIS SOFTWARE, INCLUDING ALL IMPLIED WARRANTIES OF MERCHANTABILITY AND FITNESS, IN NO EVENT SHALL DIGITAL BE LIABLE FOR ANY SPECIAL, INDIRECT OR CONSEQUENTIAL DAMAGES OR ANY DAMAGES WHATSOEVER RESULTING FROM LOSS OF USE, DATA OR PROFITS, WHETHER IN AN ACTION OF CONTRACT, NEGLIGENCE OR OTHER TORTIOUS ACTION, ARISING OUT OF OR IN CONNECTION WITH THE USE OR PERFORMANCE OF THIS SOFTWARE.

Copyright 1987 by Digital Equipment Corporation, Maynard, Massachusetts,  
Copyright 1994 Quarterdeck Office Systems.

All Rights Reserved

Permission to use, copy, modify, and distribute this software and its documentation for any purpose and without fee is hereby granted, provided that the above copyright notice appear in all copies and that both that copyright notice and this permission notice appear in supporting documentation, and that the names of Digital and Quarterdeck not be used in advertising or publicity pertaining to distribution of the software without specific, written prior permission.

DIGITAL AND QUARTERDECK DISCLAIM ALL WARRANTIES WITH REGARD TO THIS SOFTWARE, INCLUDING ALL IMPLIED WARRANTIES OF MERCHANTABILITY AND FITNESS, IN NO EVENT SHALL DIGITAL BE LIABLE FOR ANY SPECIAL, INDIRECT OR CONSEQUENTIAL DAMAGES OR ANY DAMAGES WHATSOEVER RESULTING FROM LOSS OF USE, DATA OR PROFITS, WHETHER IN AN ACTION OF CONTRACT, NEGLIGENCE OR OTHER TORTIOUS ACTION, ARISING OUT OF OR IN CONNECTION WITH THE USE OR PERFORMANCE OF THIS SOFTWARE.

Copyright 1997 Digital Equipment Corporation.  
All rights reserved.

This software is furnished under license and may be used and copied only in accordance with the following terms and conditions. Subject to these conditions, you may download, copy, install, use, modify and distribute this software in source and/or binary form. No title or ownership is transferred hereby.

1) Any source code used, modified or distributed must reproduce and retain this copyright notice and list of conditions as they appear in the source file.

2) No right is granted to use any trade name, trademark, or logo of Digital Equipment Corporation. Neither the "Digital Equipment Corporation" name nor any trademark or logo of Digital Equipment Corporation may be used to endorse or promote products derived from this software without the prior written permission of Digital Equipment Corporation.

3) This software is provided "AS-IS" and any express or implied warranties, including but not limited to, any implied warranties of merchantability, fitness for a particular purpose, or non-infringement are disclaimed. In no event shall DIGITAL be liable for any damages whatsoever, and in particular, DIGITAL shall not be liable for special, indirect, consequential, or incidental damages or damages for lost profits, loss of revenue or loss of use, whether such damages arise in contract, negligence, tort, under statute, in equity, at law or otherwise, even if advised of the possibility of such damage.

Copyright (c) 1991, 1996-1997 Digital Equipment Corporation, Maynard, Massachusetts.

Permission is hereby granted, free of charge, to any person obtaining a copy of this software and associated documentation files (the "Software"), to deal in the Software without restriction, including without limitation the rights to use, copy, modify, merge, publish, distribute, sublicense, and/or sell copies of the Software.

The above copyright notice and this permission notice shall be included in all copies or substantial portions of the Software.

THE SOFTWARE IS PROVIDED "AS IS", WITHOUT WARRANTY OF ANY KIND, EXPRESS OR IMPLIED, INCLUDING BUT NOT LIMITED TO THE WARRANTIES OF MERCHANTABILITY, FITNESS FOR A PARTICULAR PURPOSE AND NONINFRINGEMENT. IN NO EVENT SHALL DIGITAL EQUIPMENT CORPORATION BE LIABLE FOR ANY CLAIM, DAMAGES, INCLUDING, BUT NOT LIMITED TO CONSEQUENTIAL OR INCIDENTAL DAMAGES, OR OTHER LIABILITY, WHETHER IN AN ACTION OF CONTRACT, TORT OR OTHERWISE, ARISING FROM, OUT OF OR IN CONNECTION WITH THE SOFTWARE OR THE USE OR OTHER DEALINGS IN THE SOFTWARE.

Except as contained in this notice, the name of Digital Equipment Corporation shall not be used in advertising or otherwise to promote the sale, use or other dealings in this Software without prior written authorization from Digital Equipment Corporation.

SGI FREE SOFTWARE LICENSE B (Version 2.0, Sept. 18, 2008)  
Copyright (c) 1991-2000 Silicon Graphics, Inc. All Rights Reserved.

Permission is hereby granted, free of charge, to any person obtaining a copy of this software and associated documentation files (the "Software"), to deal in the Software without restriction, including without limitation the rights to use, copy, modify, merge, publish, distribute, sublicense,

and/or sell copies of the Software, and to permit persons to whom the Software is furnished to do so, subject to the following conditions:

The above copyright notice including the dates of first publication and either this permission notice or a reference to <http://oss.sgi.com/projects/FreeB/> shall be included in all copies or substantial portions of the Software.

THE SOFTWARE IS PROVIDED "AS IS", WITHOUT WARRANTY OF ANY KIND, EXPRESS OR IMPLIED, INCLUDING BUT NOT LIMITED TO THE WARRANTIES OF MERCHANTABILITY, FITNESS FOR A PARTICULAR PURPOSE AND NONINFRINGEMENT. IN NO EVENT SHALL SILICON GRAPHICS, INC. BE LIABLE FOR ANY CLAIM, DAMAGES OR OTHER LIABILITY, WHETHER IN AN ACTION OF CONTRACT, TORT OR OTHERWISE, ARISING FROM, OUT OF OR IN CONNECTION WITH THE SOFTWARE OR THE USE OR OTHER DEALINGS IN THE SOFTWARE.

Copyright (c) 1994, 1995 Hewlett-Packard Company  
Copyright (c) 2001-2004 Harold L Hunt II All Rights Reserved.  
Copyright (c) Colin Harrison 2005-2008  
Copyright (c) 1995 Kaleb S. KEITHLEY

Permission is hereby granted, free of charge, to any person obtaining a copy of this software and associated documentation files (the "Software"), to deal in the Software without restriction, including without limitation the rights to use, copy, modify, merge, publish, distribute, sublicense, and/or sell copies of the Software, and to permit persons to whom the Software is furnished to do so, subject to the following conditions:

The above copyright notice and this permission notice shall be included in all copies or substantial portions of the Software.

THE SOFTWARE IS PROVIDED "AS IS", WITHOUT WARRANTY OF ANY KIND, EXPRESS OR IMPLIED, INCLUDING BUT NOT LIMITED TO THE WARRANTIES OF MERCHANTABILITY, FITNESS FOR A PARTICULAR PURPOSE AND NONINFRINGEMENT. IN NO EVENT SHALL COPYRIGHT HOLDERS BE LIABLE FOR ANY CLAIM, DAMAGES OR OTHER LIABILITY, WHETHER IN AN ACTION OF CONTRACT, TORT OR OTHERWISE, ARISING FROM, OUT OF OR IN CONNECTION WITH THE SOFTWARE OR THE USE OR OTHER DEALINGS IN THE SOFTWARE.

Except as contained in this notice, the name of the copyright holders shall not be used in advertising or otherwise to promote the sale, use or other dealings in this Software without prior written

sale, use or other dealings in this software without prior written authorization from the copyright holders.

Copyright 1989 by Hewlett-Packard Company, Palo Alto, California.  
All Rights Reserved

Permission to use, copy, modify, and distribute this software and its documentation for any purpose and without fee is hereby granted, provided that the above copyright notice appear in all copies and that both that copyright notice and this permission notice appear in supporting documentation, and that the name of Hewlett-Packard not be used in advertising or publicity pertaining to distribution of the software without specific, written prior permission.

HEWLETT-PACKARD DISCLAIMS ALL WARRANTIES WITH REGARD TO THIS SOFTWARE, INCLUDING ALL IMPLIED WARRANTIES OF MERCHANTABILITY AND FITNESS, IN NO EVENT SHALL HEWLETT-PACKARD BE LIABLE FOR ANY SPECIAL, INDIRECT OR CONSEQUENTIAL DAMAGES OR ANY DAMAGES WHATSOEVER RESULTING FROM LOSS OF USE, DATA OR PROFITS, WHETHER IN AN ACTION OF CONTRACT, NEGLIGENCE OR OTHER TORTIOUS ACTION, ARISING OUT OF OR IN CONNECTION WITH THE USE OR PERFORMANCE OF THIS SOFTWARE.

Copyright 2001-2004 Red Hat Inc., Durham, North Carolina.  
Copyright (c) 2003 by the XFree86 Project, Inc.  
Copyright 2004-2005 Red Hat Inc., Raleigh, North Carolina.  
All Rights Reserved.

Permission is hereby granted, free of charge, to any person obtaining a copy of this software and associated documentation files (the "Software"), to deal in the Software without restriction, including without limitation on the rights to use, copy, modify, merge, publish, distribute, sublicense, and/or sell copies of the Software, and to permit persons to whom the Software is furnished to do so, subject to the following conditions:

The above copyright notice and this permission notice (including the next paragraph) shall be included in all copies or substantial portions of the Software.

THE SOFTWARE IS PROVIDED "AS IS", WITHOUT WARRANTY OF ANY KIND,

EXPRESS OR IMPLIED, INCLUDING BUT NOT LIMITED TO THE WARRANTIES OF MERCHANTABILITY, FITNESS FOR A PARTICULAR PURPOSE AND NON-INFRINGEMENT. IN NO EVENT SHALL RED HAT AND/OR THEIR SUPPLIERS BE LIABLE FOR ANY CLAIM, DAMAGES OR OTHER LIABILITY, WHETHER IN AN ACTION OF CONTRACT, TORT OR OTHERWISE, ARISING FROM, OUT OF OR IN CONNECTION WITH THE SOFTWARE OR THE USE OR OTHER DEALINGS IN THE SOFTWARE.

Copyright (c) 2008 Red Hat, Inc.

Partly based on code Copyright (c) 2000 SuSE, Inc.

Permission to use, copy, modify, distribute, and sell this software and its documentation for any purpose is hereby granted without fee, provided that the above copyright notice appear in all copies and that both that copyright notice and this permission notice appear in supporting documentation, and that the name of Red Hat not be used in advertising or publicity pertaining to distribution of the software without specific, written prior permission. Red Hat makes no representations about the suitability of this software for any purpose. It is provided "as is" without express or implied warranty.

Red Hat DISCLAIMS ALL WARRANTIES WITH REGARD TO THIS SOFTWARE, INCLUDING ALL IMPLIED WARRANTIES OF MERCHANTABILITY AND FITNESS, IN NO EVENT SHALL Red Hat BE LIABLE FOR ANY SPECIAL, INDIRECT OR CONSEQUENTIAL DAMAGES OR ANY DAMAGES WHATSOEVER RESULTING FROM LOSS OF USE, DATA OR PROFITS, WHETHER IN AN ACTION OF CONTRACT, NEGLIGENCE OR OTHER TORTIOUS ACTION, ARISING OUT OF OR IN CONNECTION WITH THE USE OR PERFORMANCE OF THIS SOFTWARE.

Copyright (c) 2006 Red Hat, Inc.

Copyright (c) 1998-1999 Precision Insight, Inc., Cedar Park, Texas.

Copyright (c) IBM Corporation 2004-2005

All Rights Reserved.

Permission is hereby granted, free of charge, to any person obtaining a copy of this software and associated documentation files (the "Software"), to deal in the Software without restriction, including without limitation the rights to use, copy, modify, merge, publish, distribute, sub license, and/or sell copies of the Software, and to permit persons to whom the Software is furnished to do so, subject to the following conditions:

The above copyright notice and this permission notice (including the next paragraph) shall be included in all copies or substantial portions of the Software.

THE SOFTWARE IS PROVIDED "AS IS", WITHOUT WARRANTY OF ANY KIND, EXPRESS OR IMPLIED, INCLUDING BUT NOT LIMITED TO THE WARRANTIES OF MERCHANTABILITY, FITNESS FOR A PARTICULAR PURPOSE AND NON-INFRINGEMENT. IN NO EVENT SHALL IBM, RED HAT, INC, OR PRECISION INSIGHT AND/OR THEIR SUPPLIERS BE LIABLE FOR ANY CLAIM, DAMAGES OR OTHER LIABILITY, WHETHER IN AN ACTION OF CONTRACT, TORT OR OTHERWISE, ARISING FROM, OUT OF OR IN CONNECTION WITH THE SOFTWARE OR THE USE OR OTHER DEALINGS IN THE SOFTWARE.

Copyright (c) 1995 X Consortium  
Copyright 2004 Red Hat Inc., Durham, North Carolina.  
All Rights Reserved.

Permission is hereby granted, free of charge, to any person obtaining a copy of this software and associated documentation files (the "Software"), to deal in the Software without restriction, including without limitation on the rights to use, copy, modify, merge, publish, distribute, sublicense, and/or sell copies of the Software, and to permit persons to whom the Software is furnished to do so, subject to the following conditions:

The above copyright notice and this permission notice shall be included in all copies or substantial portions of the Software.

THE SOFTWARE IS PROVIDED "AS IS", WITHOUT WARRANTY OF ANY KIND, EXPRESS OR IMPLIED, INCLUDING BUT NOT LIMITED TO THE WARRANTIES OF MERCHANTABILITY, FITNESS FOR A PARTICULAR PURPOSE AND NON-INFRINGEMENT. IN NO EVENT SHALL RED HAT, THE X CONSORTIUM, AND/OR THEIR SUPPLIERS BE LIABLE FOR ANY CLAIM, DAMAGES OR OTHER LIABILITY, WHETHER IN AN ACTION OF CONTRACT, TORT OR OTHERWISE, ARISING FROM, OUT OF OR IN CONNECTION WITH THE SOFTWARE OR THE USE OR OTHER DEALINGS IN THE SOFTWARE.

Except as contained in this notice, the name of the X Consortium shall not be used in advertising or otherwise to promote the sale, use or other dealings in this Software without prior written authorization from the X Consortium.

Copyright 1998-2000 Precision Insight, Inc., Cedar Park, Texas.

Copyright 2000 VA Linux Systems, Inc.

Copyright (c) 2002, 2008, 2009 Apple Computer, Inc.

Copyright (c) 2003-2004 Torrey T. Lyons.

All Rights Reserved.

Permission is hereby granted, free of charge, to any person obtaining a copy of this software and associated documentation files (the "Software"), to deal in the Software without restriction, including without limitation the rights to use, copy, modify, merge, publish, distribute, sub license, and/or sell copies of the Software, and to permit persons to whom the Software is furnished to do so, subject to the following conditions:

The above copyright notice and this permission notice (including the next paragraph) shall be included in all copies or substantial portions of the Software.

THE SOFTWARE IS PROVIDED "AS IS", WITHOUT WARRANTY OF ANY KIND, EXPRESS OR IMPLIED, INCLUDING BUT NOT LIMITED TO THE WARRANTIES OF MERCHANTABILITY, FITNESS FOR A PARTICULAR PURPOSE AND NON-INFRINGEMENT. IN NO EVENT SHALL PRECISION INSIGHT AND/OR ITS SUPPLIERS BE LIABLE FOR ANY CLAIM, DAMAGES OR OTHER LIABILITY, WHETHER IN AN ACTION OF CONTRACT, TORT OR OTHERWISE, ARISING FROM, OUT OF OR IN CONNECTION WITH THE SOFTWARE OR THE USE OR OTHER DEALINGS IN THE SOFTWARE.

(c) Copyright IBM Corporation 2002-2007

All Rights Reserved.

Permission is hereby granted, free of charge, to any person obtaining a copy of this software and associated documentation files (the "Software"), to deal in the Software without restriction, including without limitation on the rights to use, copy, modify, merge, publish, distribute, sub license, and/or sell copies of the Software, and to permit persons to whom the Software is furnished to do so, subject to the following conditions:

The above copyright notice and this permission notice (including the next paragraph) shall be included in all copies or substantial portions of the Software.

THE SOFTWARE IS PROVIDED "AS IS", WITHOUT WARRANTY OF ANY KIND, EXPRESS OR IMPLIED, INCLUDING BUT NOT LIMITED TO THE WARRANTIES OF MERCHANTABILITY, FITNESS FOR A PARTICULAR PURPOSE AND NON-INFRINGEMENT. IN NO EVENT SHALL

VA LINUX SYSTEM, IBM AND/OR THEIR SUPPLIERS BE LIABLE FOR ANY CLAIM, DAMAGES OR OTHER LIABILITY, WHETHER IN AN ACTION OF CONTRACT, TORT OR OTHERWISE, ARISING FROM, OUT OF OR IN CONNECTION WITH THE SOFTWARE OR THE USE OR OTHER DEALINGS IN THE SOFTWARE.

Copyright (c) 1997 Metro Link Incorporated

Permission is hereby granted, free of charge, to any person obtaining a copy of this software and associated documentation files (the "Software"), to deal in the Software without restriction, including without limitation the rights to use, copy, modify, merge, publish, distribute, sublicense, and/or sell copies of the Software, and to permit persons to whom the Software is furnished to do so, subject to the following conditions:

The above copyright notice and this permission notice shall be included in all copies or substantial portions of the Software.

THE SOFTWARE IS PROVIDED "AS IS", WITHOUT WARRANTY OF ANY KIND, EXPRESS OR IMPLIED, INCLUDING BUT NOT LIMITED TO THE WARRANTIES OF MERCHANTABILITY, FITNESS FOR A PARTICULAR PURPOSE AND NONINFRINGEMENT. IN NO EVENT SHALL THE X CONSORTIUM BE LIABLE FOR ANY CLAIM, DAMAGES OR OTHER LIABILITY, WHETHER IN AN ACTION OF CONTRACT, TORT OR OTHERWISE, ARISING FROM, OUT OF OR IN CONNECTION WITH THE SOFTWARE OR THE USE OR OTHER DEALINGS IN THE SOFTWARE.

Except as contained in this notice, the name of the Metro Link shall not be used in advertising or otherwise to promote the sale, use or other dealings in this Software without prior written authorization from Metro Link.

Copyright 1998 by Metro Link Incorporated

Permission to use, copy, modify, distribute, and sell this software and its documentation for any purpose is hereby granted without fee, provided that the above copyright notice appear in all copies and that both that copyright notice and this permission notice appear in supporting documentation, and that the name of Metro Link Incorporated not be used in advertising or publicity pertaining to distribution of the software without specific, written prior permission. Metro Link Incorporated makes no representations about the suitability of this software for any purpose. It is provided "as is" without express or implied warranty.

METRO LINK INCORPORATED DISCLAIMS ALL WARRANTIES WITH REGARD TO THIS SOFTWARE, INCLUDING ALL IMPLIED WARRANTIES OF MERCHANTABILITY AND FITNESS, IN NO EVENT SHALL METRO LINK INCORPORATED BE LIABLE FOR ANY SPECIAL, INDIRECT OR CONSEQUENTIAL DAMAGES OR ANY DAMAGES WHATSOEVER RESULTING FROM LOSS OF USE, DATA OR PROFITS, WHETHER IN AN ACTION OF CONTRACT, NEGLIGENCE OR OTHER TORTIOUS ACTION, ARISING OUT OF OR IN CONNECTION WITH THE USE OR PERFORMANCE OF THIS SOFTWARE.

Copyright (c) 2000 by Conectiva S.A. (<http://www.conectiva.com>)

Permission is hereby granted, free of charge, to any person obtaining a copy of this software and associated documentation files (the "Software"), to deal in the Software without restriction, including without limitation the rights to use, copy, modify, merge, publish, distribute, sublicense, and/or sell copies of the Software, and to permit persons to whom the Software is furnished to do so, subject to the following conditions:

The above copyright notice and this permission notice shall be included in all copies or substantial portions of the Software.

THE SOFTWARE IS PROVIDED "AS IS", WITHOUT WARRANTY OF ANY KIND, EXPRESS OR IMPLIED, INCLUDING BUT NOT LIMITED TO THE WARRANTIES OF MERCHANTABILITY, FITNESS FOR A PARTICULAR PURPOSE AND NONINFRINGEMENT. IN NO EVENT SHALL CONECTIVA LINUX BE LIABLE FOR ANY CLAIM, DAMAGES OR OTHER LIABILITY, WHETHER IN AN ACTION OF CONTRACT, TORT OR OTHERWISE, ARISING FROM, OUT OF OR IN CONNECTION WITH THE SOFTWARE OR THE USE OR OTHER DEALINGS IN THE SOFTWARE.

Except as contained in this notice, the name of Conectiva Linux shall not be used in advertising or otherwise to promote the sale, use or other dealings in this Software without prior written authorization from Conectiva Linux.

Copyright (c) 2001, Andy Ritger [aritger@nvidia.com](mailto:aritger@nvidia.com)  
All rights reserved.

Redistribution and use in source and binary forms, with or without modification, are permitted provided that the following conditions are met:

• Redistributions of source code must retain the above copyright

- o Redistributions of source code must retain the above copyright notice, this list of conditions and the following disclaimer.
- o Redistributions in binary form must reproduce the above copyright notice, this list of conditions and the following disclaimer in the documentation and/or other materials provided with the distribution.
- o Neither the name of NVIDIA nor the names of its contributors may be used to endorse or promote products derived from this software without specific prior written permission.

THIS SOFTWARE IS PROVIDED BY THE COPYRIGHT HOLDERS AND CONTRIBUTORS "AS IS" AND ANY EXPRESS OR IMPLIED WARRANTIES, INCLUDING, BUT NOT LIMITED TO, THE IMPLIED WARRANTIES OF MERCHANTABILITY AND FITNESS FOR A PARTICULAR PURPOSE ARE DISCLAIMED. IN NO EVENT SHALL THE REGENTS OR CONTRIBUTORS BE LIABLE FOR ANY DIRECT, INDIRECT, INCIDENTAL, SPECIAL, EXEMPLARY, OR CONSEQUENTIAL DAMAGES (INCLUDING, BUT NOT LIMITED TO, PROCUREMENT OF SUBSTITUTE GOODS OR SERVICES; LOSS OF USE, DATA, OR PROFITS; OR BUSINESS INTERRUPTION) HOWEVER CAUSED AND ON ANY THEORY OF LIABILITY, WHETHER IN CONTRACT, STRICT LIABILITY, OR TORT (INCLUDING NEGLIGENCE OR OTHERWISE) ARISING IN ANY WAY OUT OF THE USE OF THIS SOFTWARE, EVEN IF ADVISED OF THE POSSIBILITY OF SUCH DAMAGE.

Copyright 1992 Vrije Universiteit, The Netherlands  
Copyright 1998 by Concurrent Computer Corporation

Permission to use, copy, modify, and distribute this software and its documentation for any purpose and without fee is hereby granted, provided that the above copyright notice appear in all copies and that both that copyright notice and this permission notice appear in supporting documentation, and that the name of the copyright holders not be used in advertising or publicity pertaining to distribution of the software without specific, written prior permission. The copyright holders makes no representations about the suitability of this software for any purpose. It is provided "as is" without express or implied warranty.

The COPYRIGHT HOLDERS DISCLAIMS ALL WARRANTIES WITH REGARD TO THIS SOFTWARE, INCLUDING ALL IMPLIED WARRANTIES OF MERCHANTABILITY AND FITNESS, IN NO EVENT SHALL The COPYRIGHT HOLDERS BE LIABLE FOR ANY SPECIAL, INDIRECT OR CONSEQUENTIAL DAMAGES OR ANY DAMAGES WHATSOEVER RESULTING FROM LOSS OF USE, DATA OR PROFITS, WHETHER IN AN ACTION OF CONTRACT, NEGLIGENCE OR OTHER TORTIOUS ACTION, ARISING OUT OF OR IN CONNECTION WITH THE USE OR

## PERFORMANCE OF THIS SOFTWARE.

(c)Copyright 1988,1991 Adobe Systems Incorporated.  
All rights reserved.

Permission to use, copy, modify, distribute, and sublicense this software and its documentation for any purpose and without fee is hereby granted, provided that the above copyright notices appear in all copies and that both those copyright notices and this permission notice appear in supporting documentation and that the name of Adobe Systems Incorporated not be used in advertising or publicity pertaining to distribution of the software without specific, written prior permission. No trademark license to use the Adobe trademarks is hereby granted. If the Adobe trademark "Display PostScript"(tm) is used to describe this software, its functionality or for any other purpose, such use shall be limited to a statement that this software works in conjunction with the Display PostScript system. Proper trademark attribution to reflect Adobe's ownership of the trademark shall be given whenever any such reference to the Display PostScript system is made.

ADOBE MAKES NO REPRESENTATIONS ABOUT THE SUITABILITY OF THE SOFTWARE FOR ANY PURPOSE. IT IS PROVIDED "AS IS" WITHOUT EXPRESS OR IMPLIED WARRANTY. ADOBE DISCLAIMS ALL WARRANTIES WITH REGARD TO THIS SOFTWARE, INCLUDING ALL IMPLIED WARRANTIES OF MERCHANTABILITY, FITNESS FOR A PARTICULAR PURPOSE AND NON-INFRINGEMENT OF THIRD PARTY RIGHTS. IN NO EVENT SHALL ADOBE BE LIABLE TO YOU OR ANY OTHER PARTY FOR ANY SPECIAL, INDIRECT, OR CONSEQUENTIAL DAMAGES OR ANY DAMAGES WHATSOEVER WHETHER IN AN ACTION OF CONTRACT, NEGLIGENCE, STRICT LIABILITY OR ANY OTHER ACTION ARISING OUT OF OR IN CONNECTION WITH THE USE OR PERFORMANCE OF THIS SOFTWARE. ADOBE WILL NOT PROVIDE ANY TRAINING OR OTHER SUPPORT FOR THE SOFTWARE.

Adobe, PostScript, and Display PostScript are trademarks of Adobe Systems Incorporated which may be registered in certain jurisdictions.

Copyright 1989 Network Computing Devices, Inc., Mountain View, California.

Permission to use, copy, modify, and distribute this software and its documentation for any purpose and without fee is hereby granted, provided that the above copyright notice appear in all copies and that both that copyright notice and this permission notice appear in supporting documentation, and that the name of N.C.D. not be used in advertising or publicity pertaining to distribution of the software without specific,

written prior permission. N.C.D. makes no representations about the suitability of this software for any purpose. It is provided "as is" without express or implied warranty.

Copyright (c) 1987 by the Regents of the University of California

Permission to use, copy, modify, and distribute this software and its documentation for any purpose and without fee is hereby granted, provided that the above copyright notice appear in all copies. The University of California makes no representations about the suitability of this software for any purpose. It is provided "as is" without express or implied warranty.

Copyright 1992, 1993 Data General Corporation;  
Copyright 1992, 1993 OMRON Corporation

Permission to use, copy, modify, distribute, and sell this software and its documentation for any purpose is hereby granted without fee, provided that the above copyright notice appear in all copies and that both that copyright notice and this permission notice appear in supporting documentation, and that neither the name OMRON or DATA GENERAL be used in advertising or publicity pertaining to distribution of the software without specific, written prior permission of the party whose name is to be used. Neither OMRON or DATA GENERAL make any representation about the suitability of this software for any purpose. It is provided "as is" without express or implied warranty.

OMRON AND DATA GENERAL EACH DISCLAIM ALL WARRANTIES WITH REGARD TO THIS SOFTWARE, INCLUDING ALL IMPLIED WARRANTIES OF MERCHANTABILITY AND FITNESS, IN NO EVENT SHALL OMRON OR DATA GENERAL BE LIABLE FOR ANY SPECIAL, INDIRECT OR CONSEQUENTIAL DAMAGES OR ANY DAMAGES WHATSOEVER RESULTING FROM LOSS OF USE, DATA OR PROFITS, WHETHER IN AN ACTION OF CONTRACT, NEGLIGENCE OR OTHER TORTIOUS ACTION, ARISING OUT OF OR IN CONNECTION WITH THE USE OR PERFORMANCE OF THIS SOFTWARE.

Copyright (c) 1998-2004, 2006 Keith Packard  
Copyright (c) 2000 Compaq Computer Corporation  
Copyright (c) 2002 MontaVista Software Inc.  
Copyright (c) 2005 OpenedHand Ltd.  
Copyright (c) 2004, 2006 Nokia Corporation

Copyright (c) 2004, 2000 Nokia Corporation

Copyright (c) 2000-2002 Keith Packard, member of The XFree86 Project, Inc.

Copyright (c) 2002 Apple Computer, Inc.

Copyright (c) 2003 Torrey T. Lyons.

Copyright (c) 1998 Alan Hourihane, Wigan, England.

Copyright (c) 2000-2002 Alan Hourihane, Flint Mountain, North Wales.

Copyright (c) 1990,91 Thomas Roell, Dinkelscherben, Germany

Copyright (c) 1997 Matthieu Herrb

Copyright (c) 1993 David Wexelblat <dwex@goblin.org>

Copyright (c) 2005 Kean Johnston <jkj@sco.com>

Copyright (c) 1993 David McCullough <davidm@stallion.oz.au>

Copyright (c) 2003-2004 Anders Carlsson

Copyright (c) 2003-2004 Eric Anholt

Copyright (c) 2003-2004 Philip Blundell

Copyright (c) 2007 OpenedHand Ltd

Copyright (c) 1997, 1998 UCHIYAMA Yasushi

Copyright (c) 2005 Zack Rusin

Copyright (c) 2005 Lars Knoll & Zack Rusin, Trolltech

Copyright (c) 1995-1998 Metro Link, Inc.

Permission to use, copy, modify, distribute, and sell this software and its documentation for any purpose is hereby granted without fee, provided that the above copyright notice appear in all copies and that both that copyright notice and this permission notice appear in supporting documentation, and that the name of the authors and/or copyright holders not be used in advertising or publicity pertaining to distribution of the software without specific, written prior permission. The authors and/or copyright holders make no representations about the suitability of this software for any purpose. It is provided "as is" without express or implied warranty.

THE AUTHORS AND/OR COPYRIGHT HOLDERS DISCLAIM ALL WARRANTIES WITH REGARD TO THIS SOFTWARE, INCLUDING ALL IMPLIED WARRANTIES OF MERCHANTABILITY AND FITNESS, IN NO EVENT SHALL THE AUTHORS AND/OR COPYRIGHT HOLDERS BE LIABLE FOR ANY SPECIAL, INDIRECT OR CONSEQUENTIAL DAMAGES OR ANY DAMAGES WHATSOEVER RESULTING FROM LOSS OF USE, DATA OR PROFITS, WHETHER IN AN ACTION OF CONTRACT, NEGLIGENCE OR OTHER TORTIOUS ACTION, ARISING OUT OF OR IN CONNECTION WITH THE USE OR PERFORMANCE OF THIS SOFTWARE.

Copyright 1993 by Davor Matic

Permission to use, copy, modify, distribute, and sell this software and its documentation for any purpose is hereby granted without fee,

provided that the above copyright notice appear in all copies and that both that copyright notice and this permission notice appear in supporting documentation. Davor Matic makes no representations about the suitability of this software for any purpose. It is provided "as is" without express or implied warranty.

Copyright 1990,91,92,93 by Thomas Roell, Germany.

Copyright 1991,92,93 by SGCS (Snitily Graphics Consulting Services), USA.

Permission to use, copy, modify, distribute, and sell this software and its documentation for any purpose is hereby granted without fee, provided that the above copyright notice appear in all copies and that both that copyright notice and this permission notice appear in supporting documentation, and that the name of Thomas Roell nor SGCS be used in advertising or publicity pertaining to distribution of the software without specific, written prior permission.

Thomas Roell nor SGCS makes no representations about the suitability of this software for any purpose. It is provided "as is" without express or implied warranty.

THOMAS ROELL AND SGCS DISCLAIMS ALL WARRANTIES WITH REGARD TO THIS SOFTWARE, INCLUDING ALL IMPLIED WARRANTIES OF MERCHANTABILITY AND FITNESS, IN NO EVENT SHALL THOMAS ROELL OR SGCS BE LIABLE FOR ANY SPECIAL, INDIRECT OR CONSEQUENTIAL DAMAGES OR ANY DAMAGES WHATSOEVER RESULTING FROM LOSS OF USE, DATA OR PROFITS, WHETHER IN AN ACTION OF CONTRACT, NEGLIGENCE OR OTHER TORTIOUS ACTION, ARISING OUT OF OR IN CONNECTION WITH THE USE OR PERFORMANCE OF THIS SOFTWARE.

Copyright 2004, Egbert Eich

Permission is hereby granted, free of charge, to any person obtaining a copy of this software and associated documentation files (the "Software"), to deal in the Software without restriction, including without limitation the rights to use, copy, modify, merge, publish, distribute, sublicense, and/or sell copies of the Software, and to permit persons to whom the Software is furnished to do so, subject to the following conditions:

The above copyright notice and this permission notice shall be included in all copies or substantial portions of the Software.

THE SOFTWARE IS PROVIDED "AS IS", WITHOUT WARRANTY OF ANY KIND, EXPRESS OR IMPLIED, INCLUDING BUT NOT LIMITED TO THE WARRANTIES OF MERCHANTABILITY,

FITNESS FOR A PARTICULAR PURPOSE AND NONINFRINGEMENT. IN NO EVENT SHALL EGBERT EICH BE LIABLE FOR ANY CLAIM, DAMAGES OR OTHER LIABILITY, WHETHER IN AN ACTION OF CONTRACT, TORT OR OTHERWISE, ARISING FROM, OUT OF OR IN CONNECTION WITH THE SOFTWARE OR THE USE OR OTHER DEALINGS IN THE SOFTWARE.

Except as contained in this notice, the name of Egbert Eich shall not be used in advertising or otherwise to promote the sale, use or other dealings in this Software without prior written authorization from Egbert Eich.

Copyright 1992 by Orest Zborowski <obz@Kodak.com>  
Copyright 1993 by David Wexelblat <dwex@goblin.org>

Permission to use, copy, modify, distribute, and sell this software and its documentation for any purpose is hereby granted without fee, provided that the above copyright notice appear in all copies and that both that copyright notice and this permission notice appear in supporting documentation, and that the names of Orest Zborowski and David Wexelblat not be used in advertising or publicity pertaining to distribution of the software without specific, written prior permission. Orest Zborowski and David Wexelblat make no representations about the suitability of this software for any purpose. It is provided "as is" without express or implied warranty.

OREST ZBOROWSKI AND DAVID WEXELBLAT DISCLAIMS ALL WARRANTIES WITH REGARD TO THIS SOFTWARE, INCLUDING ALL IMPLIED WARRANTIES OF MERCHANTABILITY AND FITNESS, IN NO EVENT SHALL OREST ZBOROWSKI OR DAVID WEXELBLAT BE LIABLE FOR ANY SPECIAL, INDIRECT OR CONSEQUENTIAL DAMAGES OR ANY DAMAGES WHATSOEVER RESULTING FROM LOSS OF USE, DATA OR PROFITS, WHETHER IN AN ACTION OF CONTRACT, NEGLIGENCE OR OTHER TORTIOUS ACTION, ARISING OUT OF OR IN CONNECTION WITH THE USE OR PERFORMANCE OF THIS SOFTWARE.

Copyright 1992 by Orest Zborowski <obz@Kodak.com>  
Copyright 1993 by David Dawes <dawes@xfree86.org>  
Copyright 1995-1999 by Frederic Lepied, France. <fred@sugix.frmug.fr.net>  
Copyright 1992 by Rich Murphey <Rich@Rice.edu>  
Copyright 1993 by David Wexelblat <dwex@goblin.org>

Permission to use, copy, modify, distribute, and sell this software and its documentation for any purpose is hereby granted without fee, provided that the above copyright notice appear in all copies and that both that copyright notice and this permission notice appear in supporting documentation, and that the names of copyright holders

documentation, and that the names of copyright holders not be used in advertising or publicity pertaining to distribution of the software without specific, written prior permission. Copyright holders make no representations about the suitability of this software for any purpose. It is provided "as is" without express or implied warranty.

COPYRIGHT HOLDERS DISCLAIMS ALL WARRANTIES WITH REGARD TO THIS SOFTWARE, INCLUDING ALL IMPLIED WARRANTIES OF MERCHANTABILITY AND FITNESS, IN NO EVENT SHALL COPYRIGHT HOLDERS BE LIABLE FOR ANY SPECIAL, INDIRECT OR CONSEQUENTIAL DAMAGES OR ANY DAMAGES WHATSOEVER RESULTING FROM LOSS OF USE, DATA OR PROFITS, WHETHER IN AN ACTION OF CONTRACT, NEGLIGENCE OR OTHER TORTIOUS ACTION, ARISING OUT OF OR IN CONNECTION WITH THE USE OR PERFORMANCE OF THIS SOFTWARE.

Copyright (c) 1998 Todd C. Miller <Todd.Miller@courtesan.com>

Permission to use, copy, modify, and distribute this software for any purpose with or without fee is hereby granted, provided that the above copyright notice and this permission notice appear in all copies.

THE SOFTWARE IS PROVIDED "AS IS" AND TODD C. MILLER DISCLAIMS ALL WARRANTIES WITH REGARD TO THIS SOFTWARE INCLUDING ALL IMPLIED WARRANTIES OF MERCHANTABILITY AND FITNESS. IN NO EVENT SHALL TODD C. MILLER BE LIABLE FOR ANY SPECIAL, DIRECT, INDIRECT, OR CONSEQUENTIAL DAMAGES OR ANY DAMAGES WHATSOEVER RESULTING FROM LOSS OF USE, DATA OR PROFITS, WHETHER IN AN ACTION OF CONTRACT, NEGLIGENCE OR OTHER TORTIOUS ACTION, ARISING OUT OF OR IN CONNECTION WITH THE USE OR PERFORMANCE OF THIS SOFTWARE.

Copyright (c) 1994-2003 by The XFree86 Project, Inc.

Copyright 1997 by Metro Link, Inc.

Copyright 2003 by David H. Dawes.

Copyright 2003 by X-Oz Technologies.

Copyright (c) 2004, X.Org Foundation

Permission is hereby granted, free of charge, to any person obtaining a copy of this software and associated documentation files (the "Software"), to deal in the Software without restriction, including without limitation the rights to use, copy, modify, merge, publish, distribute, sublicense, and/or sell copies of the Software, and to permit persons to whom the Software is furnished to do so, subject to the following conditions:

The above copyright notice and this permission notice shall be included in all copies or substantial portions of the Software.

THE SOFTWARE IS PROVIDED "AS IS", WITHOUT WARRANTY OF ANY KIND, EXPRESS OR IMPLIED, INCLUDING BUT NOT LIMITED TO THE WARRANTIES OF MERCHANTABILITY, FITNESS FOR A PARTICULAR PURPOSE AND NONINFRINGEMENT. IN NO EVENT SHALL THE COPYRIGHT HOLDER(S) OR AUTHOR(S) BE LIABLE FOR ANY CLAIM, DAMAGES OR OTHER LIABILITY, WHETHER IN AN ACTION OF CONTRACT, TORT OR OTHERWISE, ARISING FROM, OUT OF OR IN CONNECTION WITH THE SOFTWARE OR THE USE OR OTHER DEALINGS IN THE SOFTWARE.

Except as contained in this notice, the name of the copyright holder(s) and author(s) shall not be used in advertising or otherwise to promote the sale, use or other dealings in this Software without prior written authorization from the copyright holder(s) and author(s).

Copyright 1990,91 by Thomas Roell, Dinkelscherben, Germany

Copyright 1993 by David Wexelblat <dwex@goblin.org>

Copyright 1999 by David Holland <davidh@iquest.net>

Copyright (c) 2000 Compaq Computer Corporation

Copyright (c) 2002 Hewlett-Packard Company

Copyright (c) 2004, 2005 Red Hat, Inc.

Copyright (c) 2004 Nicholas Miell

Copyright (c) 2005 Trolltech AS

Copyright (c) 2006 Intel Corporation

Copyright (c) 2006-2007 Keith Packard

Copyright (c) 2008 Red Hat, Inc

Copyright (c) 2008 George Sapountzis <gsap7@yahoo.gr>

Permission to use, copy, modify, distribute, and sell this software and its documentation for any purpose is hereby granted without fee, provided that the above copyright notice appear in all copies and that both that copyright notice and this permission notice appear in supporting documentation, and that the name of the copyright holders not be used in advertising or publicity pertaining to distribution of the software without specific, written prior permission. The copyright holders make no representations about the suitability of this software for any purpose. It is provided "as is" without express or implied warranty.

THE COPYRIGHT HOLDERS DISCLAIM ALL WARRANTIES WITH REGARD TO THIS SOFTWARE, INCLUDING ALL IMPLIED WARRANTIES OF MERCHANTABILITY AND FITNESS, IN NO EVENT SHALL THE COPYRIGHT HOLDERS BE LIABLE FOR ANY SPECIAL, INDIRECT OR CONSEQUENTIAL DAMAGES OR ANY DAMAGES

WHATSOEVER RESULTING FROM LOSS OF USE, DATA OR PROFITS, WHETHER IN AN ACTION OF CONTRACT, NEGLIGENCE OR OTHER TORTIOUS ACTION, ARISING OUT OF OR IN CONNECTION WITH THE USE OR PERFORMANCE OF THIS SOFTWARE.

Copyright 1987, 1998 The Open Group  
Copyright (c) 1998-1999, 2001 The XFree86 Project, Inc.  
Copyright (c) 2000 VA Linux Systems, Inc.  
Copyright (c) 2000, 2001 Nokia Home Communications  
Copyright (c) 2007, 2008 Red Hat, Inc.  
All rights reserved.

Permission is hereby granted, free of charge, to any person obtaining a copy of this software and associated documentation files (the "Software"), to deal in the Software without restriction, including without limitation the rights to use, copy, modify, merge, publish, distribute, and/or sell copies of the Software, and to permit persons to whom the Software is furnished to do so, provided that the above copyright notice(s) and this permission notice appear in all copies of the Software and that both the above copyright notice(s) and this permission notice appear in supporting documentation.

THE SOFTWARE IS PROVIDED "AS IS", WITHOUT WARRANTY OF ANY KIND, EXPRESS OR IMPLIED, INCLUDING BUT NOT LIMITED TO THE WARRANTIES OF MERCHANTABILITY, FITNESS FOR A PARTICULAR PURPOSE AND NONINFRINGEMENT OF THIRD PARTY RIGHTS. IN NO EVENT SHALL THE COPYRIGHT HOLDER OR HOLDERS INCLUDED IN THIS NOTICE BE LIABLE FOR ANY CLAIM, OR ANY SPECIAL INDIRECT OR CONSEQUENTIAL DAMAGES, OR ANY DAMAGES WHATSOEVER RESULTING FROM LOSS OF USE, DATA OR PROFITS, WHETHER IN AN ACTION OF CONTRACT, NEGLIGENCE OR OTHER TORTIOUS ACTION, ARISING OUT OF OR IN CONNECTION WITH THE USE OR PERFORMANCE OF THIS SOFTWARE.

Except as contained in this notice, the name of a copyright holder shall not be used in advertising or otherwise to promote the sale, use or other dealings in this Software without prior written authorization of the copyright holder.

Copyright 1996 by Thomas E. Dickey <dickey@clark.net>

All Rights Reserved

Permission to use, copy, modify, and distribute this software and its

PERMISSION TO USE, COPY, MODIFY, AND DISTRIBUTE THIS SOFTWARE AND ITS documentation for any purpose and without fee is hereby granted, provided that the above copyright notice appear in all copies and that both that copyright notice and this permission notice appear in supporting documentation, and that the name of the above listed copyright holder(s) not be used in advertising or publicity pertaining to distribution of the software without specific, written prior permission.

THE ABOVE LISTED COPYRIGHT HOLDER(S) DISCLAIM ALL WARRANTIES WITH REGARD TO THIS SOFTWARE, INCLUDING ALL IMPLIED WARRANTIES OF MERCHANTABILITY AND FITNESS, IN NO EVENT SHALL THE ABOVE LISTED COPYRIGHT HOLDER(S) BE LIABLE FOR ANY SPECIAL, INDIRECT OR CONSEQUENTIAL DAMAGES OR ANY DAMAGES WHATSOEVER RESULTING FROM LOSS OF USE, DATA OR PROFITS, WHETHER IN AN ACTION OF CONTRACT, NEGLIGENCE OR OTHER TORTIOUS ACTION, ARISING OUT OF OR IN CONNECTION WITH THE USE OR PERFORMANCE OF THIS SOFTWARE.

Copyright 1998-1999 Precision Insight, Inc., Cedar Park, Texas.

Copyright (c) 2001 Andreas Monitzer.

Copyright (c) 2001-2004 Greg Parker.

Copyright (c) 2001-2004 Torrey T. Lyons

Copyright (c) 2002-2003 Apple Computer, Inc.

Copyright (c) 2004-2005 Alexander Gottwald

Copyright (c) 2002-2009 Apple Inc.

Copyright (c) 2007 Jeremy Huddleston

All Rights Reserved.

Permission is hereby granted, free of charge, to any person obtaining a copy of this software and associated documentation files (the "Software"), to deal in the Software without restriction, including without limitation the rights to use, copy, modify, merge, publish, distribute, sublicense, and/or sell copies of the Software, and to permit persons to whom the Software is furnished to do so, subject to the following conditions:

The above copyright notice and this permission notice shall be included in all copies or substantial portions of the Software.

THE SOFTWARE IS PROVIDED "AS IS", WITHOUT WARRANTY OF ANY KIND, EXPRESS OR IMPLIED, INCLUDING BUT NOT LIMITED TO THE WARRANTIES OF MERCHANTABILITY, FITNESS FOR A PARTICULAR PURPOSE AND NONINFRINGEMENT. IN NO EVENT SHALL THE ABOVE LISTED COPYRIGHT HOLDER(S) BE LIABLE FOR ANY CLAIM, DAMAGES OR OTHER LIABILITY, WHETHER IN AN ACTION OF CONTRACT, TORT OR OTHERWISE, ARISING FROM, OUT OF OR IN CONNECTION WITH THE SOFTWARE OR THE USE OR OTHER

## DEALINGS IN THE SOFTWARE.

Except as contained in this notice, the name(s) of the above copyright holders shall not be used in advertising or otherwise to promote the sale, use or other dealings in this Software without prior written authorization.

Copyright (c) 1999,2000 by Eric Sunshine <sunshine@sunshineco.com>  
Copyright (c) 2001-2005 by Thomas Winischhofer, Vienna, Austria.

All rights reserved.

Redistribution and use in source and binary forms, with or without modification, are permitted provided that the following conditions are met:

1. Redistributions of source code must retain the above copyright notice, this list of conditions and the following disclaimer.
2. Redistributions in binary form must reproduce the above copyright notice, this list of conditions and the following disclaimer in the documentation and/or other materials provided with the distribution.
3. The name of the author may not be used to endorse or promote products derived from this software without specific prior written permission.

THIS SOFTWARE IS PROVIDED BY THE AUTHOR ``AS IS'' AND ANY EXPRESS OR IMPLIED WARRANTIES, INCLUDING, BUT NOT LIMITED TO, THE IMPLIED WARRANTIES OF MERCHANTABILITY AND FITNESS FOR A PARTICULAR PURPOSE ARE DISCLAIMED. IN NO EVENT SHALL THE AUTHOR BE LIABLE FOR ANY DIRECT, INDIRECT, INCIDENTAL, SPECIAL, EXEMPLARY, OR CONSEQUENTIAL DAMAGES (INCLUDING, BUT NOT LIMITED TO, PROCUREMENT OF SUBSTITUTE GOODS OR SERVICES; LOSS OF USE, DATA, OR PROFITS; OR BUSINESS INTERRUPTION) HOWEVER CAUSED AND ON ANY THEORY OF LIABILITY, WHETHER IN CONTRACT, STRICT LIABILITY, OR TORT (INCLUDING NEGLIGENCE OR OTHERWISE) ARISING IN ANY WAY OUT OF THE USE OF THIS SOFTWARE, EVEN IF ADVISED OF THE POSSIBILITY OF SUCH DAMAGE.

Copyright (c) 2002 David Dawes

Permission is hereby granted, free of charge, to any person obtaining a copy of this software and associated documentation files (the "Software"), to deal in the Software without restriction, including without limitation the rights to use, copy, modify, merge, publish, distribute, sublicense, and/or sell copies of the Software, and to permit persons to whom the Software is furnished to do so, subject to the following conditions:

The above copyright notice and this permission notice shall be included in all copies or substantial portions of the Software.

THE SOFTWARE IS PROVIDED "AS IS", WITHOUT WARRANTY OF ANY KIND, EXPRESS OR IMPLIED, INCLUDING BUT NOT LIMITED TO THE WARRANTIES OF MERCHANTABILITY, FITNESS FOR A PARTICULAR PURPOSE AND NONINFRINGEMENT. IN NO EVENT SHALL THE AUTHOR(S) BE LIABLE FOR ANY CLAIM, DAMAGES OR OTHER LIABILITY, WHETHER IN AN ACTION OF CONTRACT, TORT OR OTHERWISE, ARISING FROM, OUT OF OR IN CONNECTION WITH THE SOFTWARE OR THE USE OR OTHER DEALINGS IN THE SOFTWARE.

Except as contained in this notice, the name of the author(s) shall not be used in advertising or otherwise to promote the sale, use or other dealings in this Software without prior written authorization from the author(s).

Copyright (c) 1996-1999 SciTech Software, Inc.

Copyright (c) David Mosberger-Tang

Copyright (c) 1999 Egbert Eich

Copyright (c) 2008 Bart Trojanowski, Symbio Technologies, LLC

Permission to use, copy, modify, distribute, and sell this software and its documentation for any purpose is hereby granted without fee, provided that the above copyright notice appear in all copies and that both that copyright notice and this permission notice appear in supporting documentation, and that the name of the authors not be used in advertising or publicity pertaining to distribution of the software without specific, written prior permission. The authors makes no representations about the suitability of this software for any purpose. It is provided "as is" without express or implied warranty.

THE AUTHORS DISCLAIMS ALL WARRANTIES WITH REGARD TO THIS SOFTWARE, INCLUDING ALL IMPLIED WARRANTIES OF MERCHANTABILITY AND FITNESS, IN NO EVENT SHALL THE AUTHORS BE LIABLE FOR ANY SPECIAL, INDIRECT OR CONSEQUENTIAL DAMAGES OR ANY DAMAGES WHATSOEVER RESULTING FROM LOSS OF USE, DATA OR PROFITS, WHETHER IN AN ACTION OF CONTRACT, NEGLIGENCE OR OTHER TORTIOUS ACTION, ARISING OUT OF OR IN CONNECTION WITH THE USE OR PERFORMANCE OF THIS SOFTWARE.

Copyright 2005-2006 Luc Verhaegen.

Permission is hereby granted, free of charge, to any person obtaining a

PERMISSION IS HEREBY GRANTED, FREE OF CHARGE, TO ANY PERSON OBTAINING A copy of this software and associated documentation files (the "Software"), to deal in the Software without restriction, including without limitation the rights to use, copy, modify, merge, publish, distribute, sublicense, and/or sell copies of the Software, and to permit persons to whom the Software is furnished to do so, subject to the following conditions:

The above copyright notice and this permission notice shall be included in all copies or substantial portions of the Software.

THE SOFTWARE IS PROVIDED "AS IS", WITHOUT WARRANTY OF ANY KIND, EXPRESS OR IMPLIED, INCLUDING BUT NOT LIMITED TO THE WARRANTIES OF MERCHANTABILITY, FITNESS FOR A PARTICULAR PURPOSE AND NONINFRINGEMENT. IN NO EVENT SHALL THE COPYRIGHT HOLDER(S) OR AUTHOR(S) BE LIABLE FOR ANY CLAIM, DAMAGES OR OTHER LIABILITY, WHETHER IN AN ACTION OF CONTRACT, TORT OR OTHERWISE, ARISING FROM, OUT OF OR IN CONNECTION WITH THE SOFTWARE OR THE USE OR OTHER DEALINGS IN THE SOFTWARE.

Copyright 1995 by Robin Cutshaw <robin@XFree86.Org>

Copyright 2000 by Egbert Eich

Copyright 2002 by David Dawes

Copyright 1997-2004 by Marc Aurele La France (TSI @ UQV), tsi@xfree86.org

Permission to use, copy, modify, distribute, and sell this software and its documentation for any purpose is hereby granted without fee, provided that the above copyright notice appear in all copies and that both that copyright notice and this permission notice appear in supporting documentation, and that the names of the above listed copyright holder(s) not be used in advertising or publicity pertaining to distribution of the software without specific, written prior permission. The above listed copyright holder(s) make(s) no representations about the suitability of this software for any purpose. It is provided "as is" without express or implied warranty.

THE ABOVE LISTED COPYRIGHT HOLDER(S) DISCLAIM(S) ALL WARRANTIES WITH REGARD TO THIS SOFTWARE, INCLUDING ALL IMPLIED WARRANTIES OF MERCHANTABILITY AND FITNESS, IN NO EVENT SHALL THE ABOVE LISTED COPYRIGHT HOLDER(S) BE LIABLE FOR ANY SPECIAL, INDIRECT OR CONSEQUENTIAL DAMAGES OR ANY DAMAGES WHATSOEVER RESULTING FROM LOSS OF USE, DATA OR PROFITS, WHETHER IN AN ACTION OF CONTRACT, NEGLIGENCE OR OTHER TORTIOUS ACTION, ARISING OUT OF OR IN CONNECTION WITH THE USE OR PERFORMANCE OF THIS SOFTWARE.

Copyright 1990, 1991 by Thomas Roell, Dinkelscherben, Germany  
Copyright 1992 by David Dawes <dawes@XFree86.org>  
Copyright 1992 by Jim Tsillas <jtsilla@damon.ccs.northeastern.edu>  
Copyright 1992 by Rich Murphey <Rich@Rice.edu>  
Copyright 1992 by Robert Baron <Robert.Baron@ernst.mach.cs.cmu.edu>  
Copyright 1992 by Orest Zborowski <obz@eskimo.com>  
Copyright 1993 by Vrije Universiteit, The Netherlands  
Copyright 1993 by David Wexelblat <dwex@XFree86.org>  
Copyright 1994, 1996 by Holger Veit <Holger.Veit@gmd.de>  
Copyright 1997 by Takis Psarogiannakopoulos <takis@dpmmms.cam.ac.uk>  
Copyright 1994-2003 by The XFree86 Project, Inc

Permission to use, copy, modify, distribute, and sell this software and its documentation for any purpose is hereby granted without fee, provided that the above copyright notice appear in all copies and that both that copyright notice and this permission notice appear in supporting documentation, and that the names of the above listed copyright holders not be used in advertising or publicity pertaining to distribution of the software without specific, written prior permission. The above listed copyright holders make no representations about the suitability of this software for any purpose. It is provided "as is" without express or implied warranty.

THE ABOVE LISTED COPYRIGHT HOLDERS DISCLAIM ALL WARRANTIES WITH REGARD TO THIS SOFTWARE, INCLUDING ALL IMPLIED WARRANTIES OF MERCHANTABILITY AND FITNESS, IN NO EVENT SHALL THE ABOVE LISTED COPYRIGHT HOLDERS BE LIABLE FOR ANY SPECIAL, INDIRECT OR CONSEQUENTIAL DAMAGES OR ANY DAMAGES WHATSOEVER RESULTING FROM LOSS OF USE, DATA OR PROFITS, WHETHER IN AN ACTION OF CONTRACT, NEGLIGENCE OR OTHER TORTIOUS ACTION, ARISING OUT OF OR IN CONNECTION WITH THE USE OR PERFORMANCE OF THIS SOFTWARE.

Copyright 2001-2005 by J. Kean Johnston <jkj@sco.com>

Permission to use, copy, modify, distribute, and sell this software and its documentation for any purpose is hereby granted without fee, provided that the above copyright notice appear in all copies and that both that copyright notice and this permission notice appear in supporting documentation, and that the name J. Kean Johnston not be used in advertising or publicity pertaining to distribution of the software without specific, written prior permission. J. Kean Johnston makes no representations about the suitability of this software for any purpose. It is provided "as is" without express or implied warranty.

J. KEAN JOHNSTON DISCLAIMS ALL WARRANTIES WITH REGARD TO THIS SOFTWARE, INCLUDING ALL IMPLIED WARRANTIES OF MERCHANTABILITY AND FITNESS, IN NO EVENT SHALL J. KEAN JOHNSTON BE LIABLE FOR ANY SPECIAL, INDIRECT OR CONSEQUENTIAL DAMAGES OR ANY DAMAGES WHATSOEVER RESULTING FROM LOSS OF USE, DATA OR PROFITS, WHETHER IN AN ACTION OF CONTRACT, NEGLIGENCE OR OTHER TORTIOUS ACTION, ARISING OUT OF OR IN CONNECTION WITH THE USE OR PERFORMANCE OF THIS SOFTWARE.

Copyright (c) 2000 Jakub Jelinek (jakub@redhat.com)

Permission is hereby granted, free of charge, to any person obtaining a copy of this software and associated documentation files (the "Software"), to deal in the Software without restriction, including without limitation the rights to use, copy, modify, merge, publish, distribute, sublicense, and/or sell copies of the Software, and to permit persons to whom the Software is furnished to do so, subject to the following conditions:

The above copyright notice and this permission notice shall be included in all copies or substantial portions of the Software.

THE SOFTWARE IS PROVIDED "AS IS", WITHOUT WARRANTY OF ANY KIND, EXPRESS OR IMPLIED, INCLUDING BUT NOT LIMITED TO THE WARRANTIES OF MERCHANTABILITY, FITNESS FOR A PARTICULAR PURPOSE AND NONINFRINGEMENT. IN NO EVENT SHALL JAKUB JELINEK BE LIABLE FOR ANY CLAIM, DAMAGES OR OTHER LIABILITY, WHETHER IN AN ACTION OF CONTRACT, TORT OR OTHERWISE, ARISING FROM, OUT OF OR IN CONNECTION WITH THE SOFTWARE OR THE USE OR OTHER DEALINGS IN THE SOFTWARE.

Copyright (c) 1987, 1990, 1993

The Regents of the University of California. All rights reserved.

This code is derived from software contributed to Berkeley by Chris Torek.

This code is derived from software contributed to Berkeley by Michael Rendell of Memorial University of Newfoundland.

Redistribution and use in source and binary forms, with or without modification, are permitted provided that the following conditions are met:

1. Redistributions of source code must retain the above copyright notice, this list of conditions and the following disclaimer.
2. Redistributions in binary form must reproduce the above copyright

2. Redistributions in binary form must reproduce the above copyright notice, this list of conditions and the following disclaimer in the documentation and/or other materials provided with the distribution.

4. Neither the name of the University nor the names of its contributors may be used to endorse or promote products derived from this software without specific prior written permission.

THIS SOFTWARE IS PROVIDED BY THE REGENTS AND CONTRIBUTORS ``AS IS'' AND ANY EXPRESS OR IMPLIED WARRANTIES, INCLUDING, BUT NOT LIMITED TO, THE IMPLIED WARRANTIES OF MERCHANTABILITY AND FITNESS FOR A PARTICULAR PURPOSE ARE DISCLAIMED. IN NO EVENT SHALL THE REGENTS OR CONTRIBUTORS BE LIABLE FOR ANY DIRECT, INDIRECT, INCIDENTAL, SPECIAL, EXEMPLARY, OR CONSEQUENTIAL DAMAGES (INCLUDING, BUT NOT LIMITED TO, PROCUREMENT OF SUBSTITUTE GOODS OR SERVICES; LOSS OF USE, DATA, OR PROFITS; OR BUSINESS INTERRUPTION) HOWEVER CAUSED AND ON ANY THEORY OF LIABILITY, WHETHER IN CONTRACT, STRICT LIABILITY, OR TORT (INCLUDING NEGLIGENCE OR OTHERWISE) ARISING IN ANY WAY OUT OF THE USE OF THIS SOFTWARE, EVEN IF ADVISED OF THE POSSIBILITY OF SUCH DAMAGE.

---

## MPL-2.0

Mozilla Public License Version 2.0

### 1. Definitions

1.1. "Contributor" means each individual or legal entity that creates, contributes to the creation of, or owns Covered Software.

1.2. "Contributor Version" means the combination of the Contributions of others (if any) used by a Contributor and that particular Contributor's Contribution.

1.3. "Contribution" means Covered Software of a particular Contributor.

1.4. "Covered Software" means Source Code Form to which the initial Contributor has attached the notice in Exhibit A, the Executable Form of such Source Code Form, and Modifications of such Source Code Form, in each case including portions thereof.

1.5. "Incompatible With Secondary Licenses" means

(a) that the initial Contributor has attached the notice described in Exhibit B to the Covered Software; or

(b) that the Covered Software was made available under the terms of version 1.1 or earlier of the License, but not also under the terms of a Secondary License.

1.6. "Executable Form" means any form of the work other than Source Code Form.

1.7. "Larger Work" means a work that combines Covered Software with other material, in a separate file or files, that is not Covered Software.

1.8. "License" means this document.

1.9. "Licensable" means having the right to grant, to the maximum extent possible, whether at the time of the initial grant or subsequently, any and all of the rights conveyed by this License.

1.10. "Modifications" means any of the following:

(a) any file in Source Code Form that results from an addition to, deletion from, or modification of the contents of Covered Software; or

(b) any new file in Source Code Form that contains any Covered Software.

1.11. "Patent Claims" of a Contributor means any patent claim(s), including without limitation, method, process, and apparatus claims, in any patent Licensable by such Contributor that would be infringed, but for the grant of the License, by the making, using, selling, offering for sale, having made, import, or transfer of either its Contributions or its Contributor Version.

1.12. "Secondary License" means either the GNU General Public License, Version 2.0, the GNU Lesser General Public License, Version 2.1, the GNU Affero General Public License, Version 3.0, or any later versions of those licenses.

1.13. "Source Code Form" means the form of the work preferred for making modifications.

1.14. "You" (or "Your") means an individual or a legal entity exercising rights under this License. For legal entities, "You" includes any entity that controls, is controlled by, or is under common control with You. For purposes of this definition, "control" means (a) the power, direct or indirect, to cause the direction or management of such entity, whether by contract or otherwise, or (b) ownership of more than fifty percent (50%) of the outstanding shares or beneficial ownership of such entity.

## 2. License Grants and Conditions

### 2.1. Grants

Each Contributor hereby grants You a world-wide, royalty-free, non-exclusive license:

(a) under intellectual property rights (other than patent or trademark) Licensable by such Contributor to use, reproduce, make available, modify, display, perform, distribute, and otherwise exploit its Contributions, either on an unmodified basis, with Modifications, or as part of a Larger Work; and

(b) under Patent Claims of such Contributor to make, use, sell, offer for sale, have made, import, and otherwise transfer either its Contributions or its Contributor Version.

### 2.2. Effective Date

The licenses granted in Section 2.1 with respect to any Contribution become effective for each Contribution on the date the Contributor first distributes such Contribution.

### 2.3. Limitations on Grant Scope

The licenses granted in this Section 2 are the only rights granted under this License. No additional rights or licenses will be implied from the distribution or licensing of Covered Software under this License. Notwithstanding Section 2.1(b) above, no patent license is granted by a Contributor:

(a) for any code that a Contributor has removed from Covered Software; or

(b) for infringements caused by: (i) Your and any other third party's modifications of Covered Software, or (ii) the combination of its Contributions with other software (except as part of its Contributor Version); or

(c) under Patent Claims infringed by Covered Software in the absence of its Contributions.

This License does not grant any rights in the trademarks, service marks, or logos of any Contributor (except as may be necessary to comply with the notice requirements in Section 3.4).

### 2.4. Subsequent Licenses

No Contributor makes additional grants as a result of Your choice to distribute the Covered Software under a subsequent version of this License (see Section 10.2) or under the terms of a Secondary License (if permitted under the terms of Section 3.3).

### 2.5. Representation

Each Contributor represents that the Contributor believes its Contributions are its original creation(s) or it has sufficient rights to grant the rights to its Contributions conveyed by this License.

## 2.6. Fair Use

This License is not intended to limit any rights You have under applicable copyright doctrines of fair use, fair dealing, or other equivalents.

## 2.7. Conditions

Sections 3.1, 3.2, 3.3, and 3.4 are conditions of the licenses granted in Section 2.1.

## 3. Responsibilities

### 3.1. Distribution of Source Form

All distribution of Covered Software in Source Code Form, including any Modifications that You create or to which You contribute, must be under the terms of this License. You must inform recipients that the Source Code Form of the Covered Software is governed by the terms of this License, and how they can obtain a copy of this License. You may not attempt to alter or restrict the recipients' rights in the Source Code Form.

### 3.2. Distribution of Executable Form

If You distribute Covered Software in Executable Form then:

(a) such Covered Software must also be made available in Source Code Form, as described in Section 3.1, and You must inform recipients of the Executable Form how they can obtain a copy of such Source Code Form by reasonable means in a timely manner, at a charge no more than the cost of distribution to the recipient; and

(b) You may distribute such Executable Form under the terms of this License, or sublicense it under different terms, provided that the license for the Executable Form does not attempt to limit or alter the recipients' rights in the Source Code Form under this License.

### 3.3. Distribution of a Larger Work

You may create and distribute a Larger Work under terms of Your choice, provided that You also comply with the requirements of this License for the Covered Software. If the Larger Work is a combination of Covered Software with a work governed by one or more Secondary Licenses, and the Covered Software is not Incompatible With Secondary Licenses, this License permits You to additionally distribute such Covered Software under the terms of such Secondary License(s), so that the recipient of the Larger Work may, at their option, further distribute the Covered Software under the terms of either this License or such Secondary License(s).

### 3.4. Notices

You may not remove or alter the substance of any license notices (including copyright notices, patent notices, disclaimers of warranty, or limitations of liability) contained within the Source Code Form of the Covered Software, except that You may alter any license notices to the extent required to remedy known factual inaccuracies.

### 3.5. Application of Additional Terms

You may choose to offer, and to charge a fee for, warranty, support, indemnity or liability obligations to one or more recipients of Covered Software. However, You may do so only on Your own behalf, and not on behalf of any Contributor. You must make it absolutely clear that any such warranty, support, indemnity, or liability obligation is offered by You alone, and You hereby agree to indemnify every Contributor for any liability incurred by such Contributor as a result of warranty, support, indemnity or liability terms You offer. You may include additional disclaimers of warranty and limitations of liability specific to any jurisdiction.

### 4. Inability to Comply Due to Statute or Regulation

If it is impossible for You to comply with any of the terms of this License with respect to some or all of the Covered Software due to statute, judicial order, or regulation then You must: (a) comply with the terms of this License to the maximum extent possible; and (b) describe the limitations and the code they affect. Such description must be placed in a text file included with all distributions of the Covered Software under this License. Except to the extent prohibited by statute or regulation, such description must be sufficiently detailed for a recipient of ordinary skill to be able to understand it.

### 5. Termination

5.1. The rights granted under this License will terminate automatically if You fail to comply with any of its terms. However, if You become compliant, then the rights granted under this License from a particular Contributor are reinstated (a) provisionally, unless and until such Contributor explicitly and finally terminates Your grants, and (b) on an ongoing basis, if such Contributor fails to notify You of the non-compliance by some reasonable means prior to 60 days after You have come back into compliance. Moreover, Your grants from a particular Contributor are reinstated on an ongoing basis if such Contributor notifies You of the non-compliance by some reasonable means, this is the first time You have received notice of non-compliance with this License from such Contributor, and You become compliant prior to 30 days after Your receipt of the notice.

5.2. If You initiate litigation against any entity by asserting a patent infringement claim (excluding declaratory judgment actions, counter-claims, and cross-claims) alleging that a Contributor Version directly or indirectly infringes any patent, then the rights granted to You by any and all Contributors for the Covered Software under Section 2.1 of this License shall terminate.

5.3. In the event of termination under Sections 5.1 or 5.2 above, all end user license agreements (excluding distributors and resellers) which have been validly granted by You or Your distributors under this License prior to termination shall survive termination.

### 6 Disclaimer of Warranty



## 10.2. Effect of New Versions

You may distribute the Covered Software under the terms of the version of the License under which You originally received the Covered Software, or under the terms of any subsequent version published by the license steward.

## 10.3. Modified Versions

If you create software not governed by this License, and you want to create a new license for such software, you may create and use a modified version of this License if you rename the license and remove any references to the name of the license steward (except to note that such modified license differs from this License).

## 10.4. Distributing Source Code Form that is Incompatible With Secondary Licenses

If You choose to distribute Source Code Form that is Incompatible With Secondary Licenses under the terms of this version of the License, the notice described in Exhibit B of this License must be attached.

### Exhibit A - Source Code Form License Notice

This Source Code Form is subject to the terms of the Mozilla Public License, v. 2.0. If a copy of the MPL was not distributed with this file, You can obtain one at <http://mozilla.org/MPL/2.0/>.

If it is not possible or desirable to put the notice in a particular file, then You may include the notice in a location (such as a LICENSE file in a relevant directory) where a recipient would be likely to look for such a notice.

You may add additional accurate notices of copyright ownership.

### Exhibit B - "Incompatible With Secondary Licenses" Notice

This Source Code Form is "Incompatible With Secondary Licenses", as defined by the Mozilla Public License, v. 2.0.

---

## **NTP**

NTP License (NTP)

Copyright (c) (CopyrightHoldersName) (From 4-digit-year)-(To 4-digit-year)

Permission to use, copy, modify, and distribute this software and its documentation for any

purpose with or without fee is hereby granted, provided that the above copyright notice appears in all copies and that both the copyright notice and this permission notice appear in supporting documentation, and that the name (TrademarkedName) not be used in advertising or publicity pertaining to distribution of the software without specific, written prior permission. (TrademarkedName) makes no representations about the suitability this software for any purpose. It is provided "as is" without express or implied warranty.

---

## OpenSSL

### OpenSSL License

Copyright (c) 1998-2008 The OpenSSL Project. All rights reserved.

Redistribution and use in source and binary forms, with or without modification, are permitted provided that the following conditions are met:

1. Redistributions of source code must retain the above copyright notice, this list of conditions and the following disclaimer.
2. Redistributions in binary form must reproduce the above copyright notice, this list of conditions and the following disclaimer in the documentation and/or other materials provided with the distribution.
3. All advertising materials mentioning features or use of this software must display the following acknowledgment: "This product includes software developed by the OpenSSL Project for use in the OpenSSL Toolkit. (<http://www.openssl.org/>)"
4. The names "OpenSSL Toolkit" and "OpenSSL Project" must not be used to endorse or promote products derived from this software without prior written permission. For written permission, please contact [openssl-core@openssl.org](mailto:openssl-core@openssl.org).
5. Products derived from this software may not be called "OpenSSL" nor may "OpenSSL" appear in their names without prior written permission of the OpenSSL Project.
6. Redistributions of any form whatsoever must retain the following acknowledgment: "This product includes software developed by the OpenSSL Project for use in the OpenSSL Toolkit (<http://www.openssl.org/>)"

THIS SOFTWARE IS PROVIDED BY THE OpenSSL PROJECT ``AS IS'' AND ANY EXPRESSED OR

IMPLIED WARRANTIES, INCLUDING, BUT NOT LIMITED TO, THE IMPLIED WARRANTIES OF MERCHANTABILITY AND FITNESS FOR A PARTICULAR PURPOSE ARE DISCLAIMED. IN NO EVENT SHALL THE OpenSSL PROJECT OR ITS CONTRIBUTORS BE LIABLE FOR ANY DIRECT, INDIRECT, INCIDENTAL, SPECIAL, EXEMPLARY, OR CONSEQUENTIAL DAMAGES (INCLUDING, BUT NOT LIMITED TO, PROCUREMENT OF SUBSTITUTE GOODS OR SERVICES; LOSS OF USE, DATA, OR PROFITS; OR BUSINESS INTERRUPTION) HOWEVER CAUSED AND ON ANY THEORY OF LIABILITY, WHETHER IN CONTRACT, STRICT LIABILITY, OR TORT (INCLUDING NEGLIGENCE OR OTHERWISE) ARISING IN ANY WAY OUT OF THE USE OF THIS SOFTWARE, EVEN IF ADVISED OF THE POSSIBILITY OF SUCH DAMAGE.

This product includes cryptographic software written by Eric Young (eay@cryptsoft.com). This product includes software written by Tim Hudson (tjh@cryptsoft.com).

## Original SSLeay License

Copyright (C) 1995-1998 Eric Young (eay@cryptsoft.com) All rights reserved.

This package is an SSL implementation written by Eric Young (eay@cryptsoft.com). The implementation was written so as to conform with Netscapes SSL.

This library is free for commercial and non-commercial use as long as the following conditions are aheared to. The following conditions apply to all code found in this distribution, be it the RC4, RSA, lhash, DES, etc., code; not just the SSL code. The SSL documentation included with this distribution is covered by the same copyright terms except that the holder is Tim Hudson (tjh@cryptsoft.com).

Copyright remains Eric Young's, and as such any Copyright notices in the code are not to be removed. If this package is used in a product, Eric Young should be given attribution as the author of the parts of the library used. This can be in the form of a textual message at program startup or in documentation (online or textual) provided with the package.

Redistribution and use in source and binary forms, with or without modification, are permitted provided that the following conditions are met:

1. Redistributions of source code must retain the copyright notice, this list of conditions and the following disclaimer.
2. Redistributions in binary form must reproduce the above copyright notice, this list of conditions and the following disclaimer in the documentation and/or other materials provided with the distribution.
3. All advertising materials mentioning features or use of this software must display the following acknowledgement:

"This product includes cryptographic software written by Eric Young (eay@cryptsoft.com)"  
The word 'cryptographic' can be left out if the routines from the library being used are not cryptographic related :-).

4. If you include any Windows specific code (or a derivative thereof) from the apps directory (application code) you must include an acknowledgement: "This product includes software written by Tim Hudson (tjh@cryptsoft.com)"

THIS SOFTWARE IS PROVIDED BY ERIC YOUNG ``AS IS'' AND ANY EXPRESS OR IMPLIED WARRANTIES, INCLUDING, BUT NOT LIMITED TO, THE IMPLIED WARRANTIES OF MERCHANTABILITY AND FITNESS FOR A PARTICULAR PURPOSE ARE DISCLAIMED. IN NO EVENT SHALL THE AUTHOR OR CONTRIBUTORS BE LIABLE FOR ANY DIRECT, INDIRECT, INCIDENTAL, SPECIAL, EXEMPLARY, OR CONSEQUENTIAL DAMAGES (INCLUDING, BUT NOT LIMITED TO, PROCUREMENT OF SUBSTITUTE GOODS OR SERVICES; LOSS OF USE, DATA, OR PROFITS; OR BUSINESS INTERRUPTION) HOWEVER CAUSED AND ON ANY THEORY OF LIABILITY, WHETHER IN CONTRACT, STRICT LIABILITY, OR TORT (INCLUDING NEGLIGENCE OR OTHERWISE) ARISING IN ANY WAY OUT OF THE USE OF THIS SOFTWARE, EVEN IF ADVISED OF THE POSSIBILITY OF SUCH DAMAGE.

The licence and distribution terms for any publically available version or derivative of this code cannot be changed. i.e. this code cannot simply be copied and put under another distribution licence [including the GNU Public Licence.]

---

## The Open Group License

Permission to use, copy, modify, distribute, and sell this software and its documentation for any purpose is hereby granted without fee, provided that the above copyright notice appear in all copies and that both that copyright notice and this permission notice appear in supporting documentation.

The above copyright notice and this permission notice shall be included in all copies or substantial portions of the Software.

THE SOFTWARE IS PROVIDED "AS IS", WITHOUT WARRANTY OF ANY KIND, EXPRESS OR IMPLIED, INCLUDING BUT NOT LIMITED TO THE WARRANTIES OF MERCHANTABILITY, FITNESS FOR A PARTICULAR PURPOSE AND NONINFRINGEMENT. IN NO EVENT SHALL THE OPEN GROUP BE LIABLE FOR ANY CLAIM, DAMAGES OR OTHER LIABILITY, WHETHER IN AN ACTION OF CONTRACT, TORT OR OTHERWISE, ARISING FROM, OUT OF OR IN CONNECTION

WITH THE SOFTWARE OR THE USE OR OTHER DEALINGS IN THE SOFTWARE.

Except as contained in this notice, the name of The Open Group shall not be used in advertising or otherwise to promote the sale, use or other dealings in this Software without prior written authorization from The Open Group.

---

## **X11**

Permission is hereby granted, free of charge, to any person obtaining a copy of this software and associated documentation files (the "Software"), to deal in the Software without restriction, including without limitation the rights to use, copy, modify, merge, publish, distribute, sublicense, and/or sell copies of the Software, and to permit persons to whom the Software is furnished to do so, subject to the following conditions:

The above copyright notice and this permission notice shall be included in all copies or substantial portions of the Software.

THE SOFTWARE IS PROVIDED "AS IS", WITHOUT WARRANTY OF ANY KIND, EXPRESS OR IMPLIED, INCLUDING BUT NOT LIMITED TO THE WARRANTIES OF MERCHANTABILITY, FITNESS FOR A PARTICULAR PURPOSE AND NONINFRINGEMENT. IN NO EVENT SHALL THE AUTHORS OR COPYRIGHT HOLDERS BE LIABLE FOR ANY CLAIM, DAMAGES OR OTHER LIABILITY, WHETHER IN AN ACTION OF CONTRACT, TORT OR OTHERWISE, ARISING FROM, OUT OF OR IN CONNECTION WITH THE SOFTWARE OR THE USE OR OTHER DEALINGS IN THE SOFTWARE.

Except as contained in this notice, the name of the authors or copyright holders shall not be used in advertising or otherwise to promote the sale, use or other dealings in this Software without prior written authorization from the authors or copyright holders.

---

## **Zlib**

zlib License

This software is provided 'as-is', without any express or implied warranty. In no event will the authors be held liable for any damages arising from the use of this software.

Permission is granted to anyone to use this software for any purpose, including commercial applications, and to alter it and redistribute it freely, subject to the following restrictions:

1. The origin of this software must not be misrepresented; you must not claim that you wrote the original software. If you use this software in a product, an acknowledgment in the product documentation would be appreciated but is not required.
2. Altered source versions must be plainly marked as such, and must not be misrepresented as being the original software.
3. This notice may not be removed or altered from any source distribution.

---

## **bzip2-1.0.6**

This program, "bzip2", the associated library "libbzip2", and all documentation, are copyright (C) 1996-2010 Julian R Seward. All rights reserved.

Redistribution and use in source and binary forms, with or without modification, are permitted provided that the following conditions are met:

1. Redistributions of source code must retain the above copyright notice, this list of conditions and the following disclaimer.
2. The origin of this software must not be misrepresented; you must not claim that you wrote the original software. If you use this software in a product, an acknowledgment in the product documentation would be appreciated but is not required.
3. Altered source versions must be plainly marked as such, and must not be misrepresented as being the original software.
4. The name of the author may not be used to endorse or promote products derived from this software without specific prior written permission.

THIS SOFTWARE IS PROVIDED BY THE AUTHOR ``AS IS'' AND ANY EXPRESS OR IMPLIED WARRANTIES, INCLUDING, BUT NOT LIMITED TO, THE IMPLIED WARRANTIES OF MERCHANTABILITY AND FITNESS FOR A PARTICULAR PURPOSE ARE DISCLAIMED. IN NO EVENT SHALL THE AUTHOR BE LIABLE FOR ANY DIRECT, INDIRECT, INCIDENTAL, SPECIAL, EXEMPLARY, OR CONSEQUENTIAL DAMAGES (INCLUDING, BUT NOT LIMITED TO,

PROCUREMENT OF SUBSTITUTE GOODS OR SERVICES; LOSS OF USE, DATA, OR PROFITS; OR BUSINESS INTERRUPTION) HOWEVER CAUSED AND ON ANY THEORY OF LIABILITY, WHETHER IN CONTRACT, STRICT LIABILITY, OR TORT (INCLUDING NEGLIGENCE OR OTHERWISE) ARISING IN ANY WAY OUT OF THE USE OF THIS SOFTWARE, EVEN IF ADVISED OF THE POSSIBILITY OF SUCH DAMAGE.

Julian Seward, [jseward@bzip.org](mailto:jseward@bzip.org) bzip2/libbzip2 version 1.0.6 of 6 September 2010

---

## **curl**

Copyright (c) 1996 - 2015, Daniel Stenberg, <[daniel@haxx.se](mailto:daniel@haxx.se)>.

All rights reserved.

Permission to use, copy, modify, and distribute this software for any purpose with or without fee is hereby granted, provided that the above copyright notice and this permission notice appear in all copies.

THE SOFTWARE IS PROVIDED "AS IS", WITHOUT WARRANTY OF ANY KIND, EXPRESS OR IMPLIED, INCLUDING BUT NOT LIMITED TO THE WARRANTIES OF MERCHANTABILITY, FITNESS FOR A PARTICULAR PURPOSE AND NONINFRINGEMENT OF THIRD PARTY RIGHTS. IN NO EVENT SHALL THE AUTHORS OR COPYRIGHT HOLDERS BE LIABLE FOR ANY CLAIM, DAMAGES OR OTHER LIABILITY, WHETHER IN AN ACTION OF CONTRACT, TORT OR OTHERWISE, ARISING FROM, OUT OF OR IN CONNECTION WITH THE SOFTWARE OR THE USE OR OTHER DEALINGS IN THE SOFTWARE.

Except as contained in this notice, the name of a copyright holder shall not be used in advertising or otherwise to promote the sale, use or other dealings in this Software without prior written authorization of the copyright holder.

---

## **libtiff**

Permission to use, copy, modify, distribute, and sell this software and its documentation for any purpose is hereby granted without fee, provided that (i) the above copyright notices and this permission notice appear in all copies of the software and related documentation, and (ii) the names of Sam Leffler and Silicon Graphics may not be used in any advertising or

publicity relating to the software without the specific, prior written permission of Sam Leffler and Silicon Graphics.

THE SOFTWARE IS PROVIDED "AS-IS" AND WITHOUT WARRANTY OF ANY KIND, EXPRESS, IMPLIED OR OTHERWISE, INCLUDING WITHOUT LIMITATION, ANY WARRANTY OF MERCHANTABILITY OR FITNESS FOR A PARTICULAR PURPOSE.

IN NO EVENT SHALL SAM LEFFLER OR SILICON GRAPHICS BE LIABLE FOR ANY SPECIAL, INCIDENTAL, INDIRECT OR CONSEQUENTIAL DAMAGES OF ANY KIND, OR ANY DAMAGES WHATSOEVER RESULTING FROM LOSS OF USE, DATA OR PROFITS, WHETHER OR NOT ADVISED OF THE POSSIBILITY OF DAMAGE, AND ON ANY THEORY OF LIABILITY, ARISING OUT OF OR IN CONNECTION WITH THE USE OR PERFORMANCE OF THIS SOFTWARE.