

SENCOR®

SLE XXX802TCSB



EN ■ QUICK GUIDE
CZ ■ RYCHLÝ PRŮVODCE
SK ■ RÝCHLY SPRIEVODCA
HU ■ GYORS ÚTMUTATÓ
PL ■ KRÓTKI PRZEWODNIK

LED TV
LED TV
LED TV
LED TV
LED TV

English	3
Čeština	9
Slovenčina	15
Magyar	21
Polski	27
Product Information Sheet	33
Informační list produktu	33
Informačný list produktu	33
Termékinformációs lap	33
Arkusz informacji o produkcie	33

LICENSES:



1. Safety instructions

To be able to use this product properly, read this user's manual carefully and keep it for future reference. If you plan to give (sell) this device to a third person, include all documentation, including this manual, with the transaction.

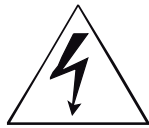

The lightning symbol inside a triangle indicates the device has dangerous voltage that may cause electric shock.



The exclamation point symbol inside an isosceles triangle indicates important operation and repair instructions in the included device documentation.

WARNING

RISK OF ELECTRIC SHOCK – DO NOT OPEN!

TO REDUCE THE RISK OF ELECTRIC SHOCK, DO NOT REMOVE THE COVER (OR BACK SIDE). THERE ARE NO PARTS INSIDE THE DEVICE REPLACEABLE BY THE USER. FOR REPAIRS, CONTACT AND AUTHORIZED SERVICE PROVIDER.

WARNING:

To prevent risk of fire or electric shock, do not expose the device to rain or moisture. The batteries must not be exposed to excessive heat, for example sunlight, fire, etc.



This symbol indicates the device has double insulation between dangerous voltage from the network and user-accessible parts. Replace parts with identical spare parts only.

- Do not leave a static image on the LCD panel for more than 2 hours. The panel might get damaged.

- LCD screens are made using precision technology to provide even the finest image details. Several defective pixels can appear on the screen from time to time, indicated as red, blue, green or black dots (up to 0.001% of the total pixel count of the screen). This does not affect the characteristics and the effectiveness of your TV set.

Before use, please read the detailed safety information in the full user manual available on the website www.sencor.com

2. Installing the stand

Use the supplied or recommended screws to attach the stand. Make sure the supports are properly attached to keep the TV stable. Then connect the TV to the power supply.

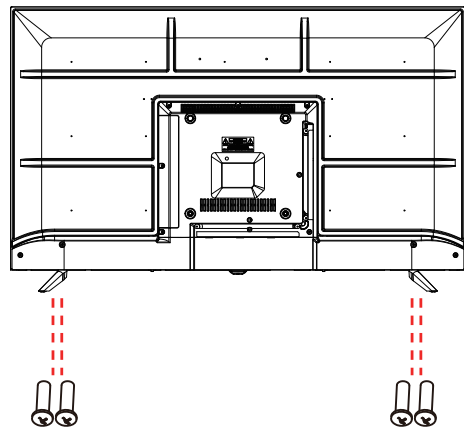

3. Inserting batteries

Open the battery compartment. Insert two AAA batteries. Place the cover back on. Insert two AA batteries into the Magic controller (UHD models only).

4. TV connectors

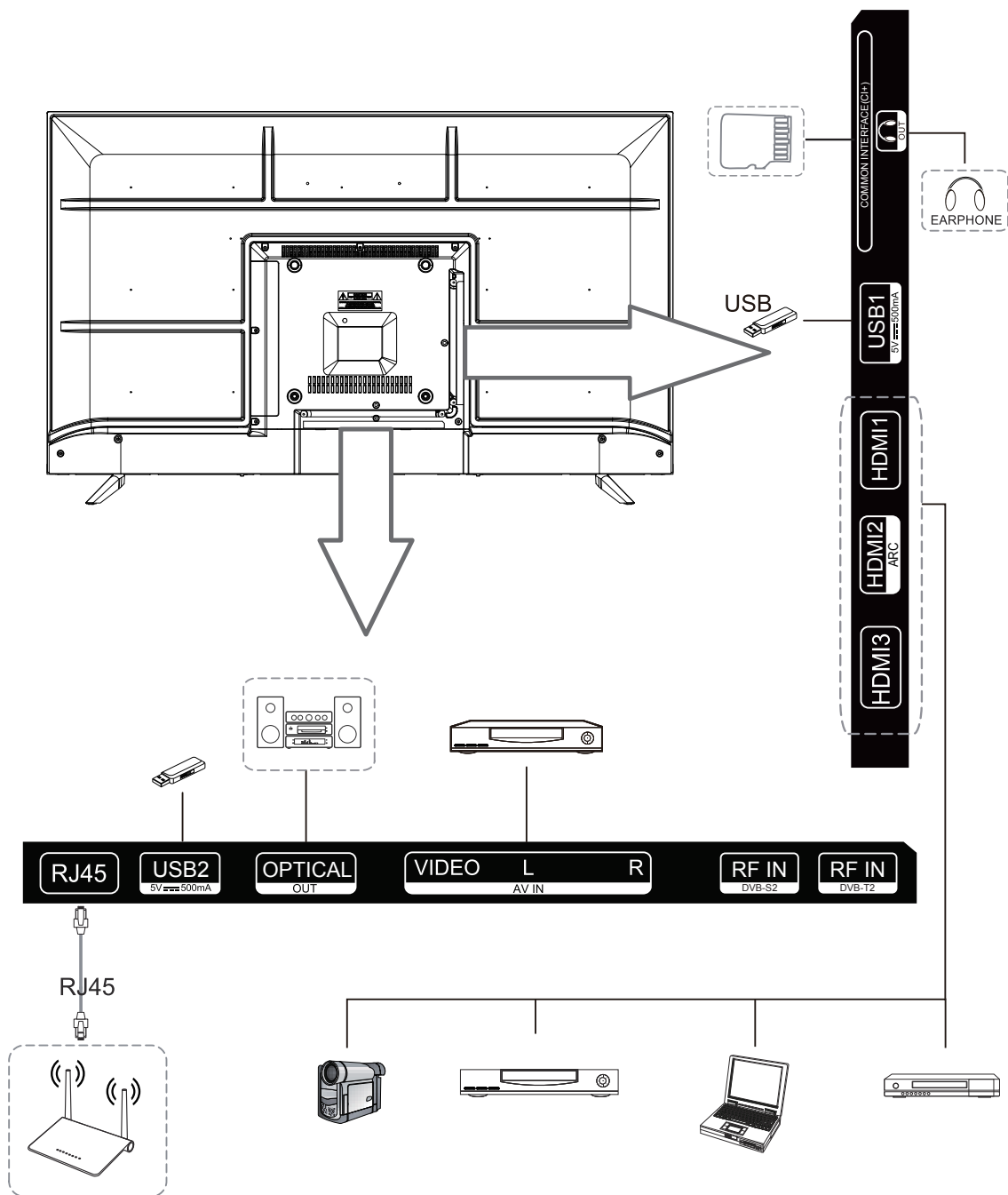

5. Remote controller

POWER: power ON/OFF.

TV/RAD: Switch to TV or radio.

 : Search.

SUBTITLE: Subtitles On/Off.

 : Enter the quick setup menu.

 : Input source selection.

0-9: Numeric keys.

LIST: Channel list.

... : Show other actions.

 : Setting the volume.

 : Channel switching.

AD: Enabling / disabling the AD function.

GUIDE: TV programme display.

 : Mute.

 : Play.

 : Shows main menu.

|| : Pause.

BACK: Back to the previous step.

EXIT: Closes the menu.

 : Selects the currently highlighted option.

 : The RIGHT/LEFT/UP/DOWN buttons to move through the menu.

TEXT: Opens teletext.

T.OPT: Open the teletext function menu.

MOVIES: Movie search.

REC: Starts recording.

 : Starts live playback.

NETFLIX: launches Netflix.

 : launches Prime video.

 : Correspond various color functions in the menu or in the teletext.



6. Magic Controller

When paired with the TV, the Magic controller offers an additional cursor for control.

: TV ON/OFF.

: STB ON/OFF.

1-9: numeric keys

: Channel list

 **QUICK ACCESS**: Short press: Number button / Long press: Quick access

... **AD/SAP**: Short press: Other actions
Long press: Audio description

: Mute.

: Setting the volume.

: Channel switching.

: Activates voice recognition.

: Shows main menu.

: Enter the quick setup menu.

WHEEL UP: Scroll up / Go to a higher channel

PRESSING THE WHEEL: Confirmation

WHEEL DOWN: Scroll down / Go to a lower channel

: The RIGHT/LEFT/UP/DOWN buttons to move through the menu.

: Go back.

GUIDE: TV programme display.

: Input source selection.





MOVIES: Movie selection menu.

: Play.

: Pause.

NETFLIX: launches Netflix.

: launches Prime video.

   : Correspond various color functions in the menu or in the teletext.

The icons and positions of the remote control buttons may vary depending on the model.



7. TV control buttons

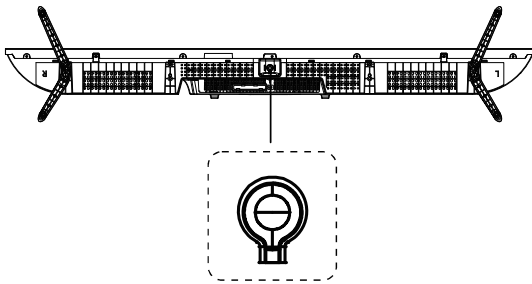

 : TV ON/OFF.

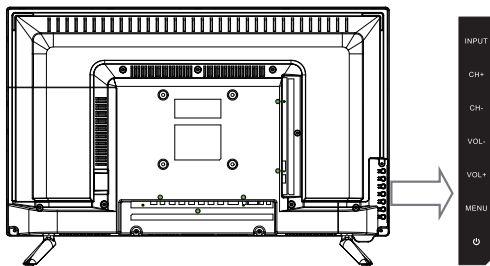

INPUT: Source select.

CH+: Selects channel.

CH-: Selects channel.

VOL-: Lowers volume.

VOL+: Raises volume.

MENU: Enters the menu.

 : TV POWER ON/OFF

8. After you first turn on the TV

When you first turn on your TV, you'll see a welcome screen where you can select your language and country. Next, select the signal source and perform the initial tuning as instructed on the screen.

9. Included accessories

- Magic Remote (UHD models only)
- Basic remote controller
- Quick guide
- 2 AAA batteries, 2 AA batteries (for Magic controller only)
- Stand and fixing screws

10. Playing from USB disc

Connect a USB device. Press HOME on the remote controller. Open the Photo & Video app. Select the desired storage device. Select and view the desired photo or video.

Compatibility with all USB devices is not guaranteed. Use file system FAT32/NTFS, single partition, no protection. Formatting permanently erases all contents of the memory device! First, test the speed and reliability of each USB device. When the result is unsatisfactory, replace it with another one, mainly faster. The speed of a USB storage device is a prerequisite for reliable recording and time-shifting.

Supported USB formats

Video: AVI, MP4, MPG, MKV, MOV, DAT, VOB

Audio: MP3, WAV, OGG, FLAC

Pictures: JPEG, JPG, PNG

11. Full text of the operating instructions

The full instruction manual is available at www.sencor.com or directly on the TV.

INSTRUCTIONS AND INFORMATION REGARDING THE DISPOSAL OF USED PACKAGING

Dispose of the packaging material at a public waste disposal site.



DISPOSAL OF USED ELECTRICAL AND ELECTRONIC EQUIPMENT

The symbol on the product, its accessories or packaging indicates that the product must not be disposed of in household waste. Dispose of the equipment at an appropriate collection point for the recycling of electrical and electronic equipment. Alternatively, in some European Union states or other European countries you may return your products to your local retailer when buying an equivalent new product.

Correct disposal of this product will help save valuable natural resources and prevent any potential negative impacts on the environment and human health, which could otherwise be caused by improper waste disposal. Contact your local authority or nearest waste collection centre for more details. Improper disposal of this type of waste may be subject to national rules on fines.

For business entities in the European Union

To dispose of electrical or electronic device, request the necessary information from your vendor or supplier.

Disposal in other countries outside the European Union

To dispose of this product, request the necessary information about the correct disposal method from local government departments or from your vendor.



Hereby FAST CR, a.s. declares that the type of SLE 43FS802TCSB, SLE 32S802TCSB and SLE 24S802TCSB are in compliance with Directive 2014/53/EU.

The full text of the EU Declaration of Conformity is available at the following website: www.sencor.com

Text, design and technical specifications are subject to change without notice and we reserve the right to make changes.

Product Information Sheet

COMMISSION DELEGATED REGULATION (EU) 2019/2013 with regard to energy labelling of electronic displays

	Parameter	Parameter or value and precision	Parameter or value and precision	Parameter or value and precision	Unit
1.	Supplier's name or trademark.	SENCOR	SENCOR	SENCOR	
	Supplier's address.	-	-	-	
2.	Model identifier	SLE 24S802TCSB	SLE 32S802TCSB	SLE 43FS802TCSB	
3.	Energy Efficiency Class for Standard Dynamic Range (SDR)	E	E	F	
4.	On mode power demand in SDR	17,0	24,0	45,0	W
5.	Energy Efficiency Class for High Dynamic Range (HDR)	G	n.a.	n.a.	
6.	On mode power demand in HDR, if implemented	24,0	n.a.	n.a.	W
7.	Off mode, power demand, if applicable	0,0	0,0	0,0	W
8.	Standby mode power demand, if applicable	0,3	0,5	0,5	W
9.	Networked standby mode power demand, if applicable	0,4	2,0	2,0	W
10.	Electronic display category	Television	Television	Television	
11.	Size ratio	16 : 9	16 : 9	16 : 9	
12.	Screen resolution	1 366 x 768	1 366 x 768	1 920 x 1 080	pixels
13.	Screen diagonal	60,0	80,0	108,0	cm
14.	Screen diagonal	24	32	43	inches
15.	Visible screen area	15,3	23,7	49,7	dm ²
16.	Panel technology used	LED LCD	LED LCD	LED LCD	
17.	Automatic Brightness Control (ABC) available	No	No	No	
18.	Voice recognition sensor available	No	No	No	
19.	Room presence sensor available	No	No	No	
20.	Image refresh frequency rate (default)	60	60	60	Hz
21.	Minimum guaranteed availability of software and firmware updates (from the date of end of the placement on the market)	8	8	8	Years
22.	Minimum guaranteed availability of spare parts (from the date of end of the placement on the market)	7	7	7	Years
23.	Minimum guaranteed product support	8	8	8	Years
	Minimum duration of the general guarantee offered by the supplier	2	2	2	Years
24.	Power supply type	Internal	Internal	Internal	
25.	External power supply (non standardized and included in the product box)				
	<i>i</i> -				
	<i>ii</i> Input voltage	-	-	-	V
	<i>iii</i> Output voltage	-	-	-	V
26.	External standardised power supply (or suitable one if not included in the product box)				
	<i>i</i> -				
	<i>ii</i> Required output voltage	-	-	-	V
	<i>iii</i> Required delivered current (minimum)	-	-	-	A
	<i>iv</i> Required current frequency	-	-	-	Hz

#	CZ	SK	HU	PL
1	Název nebo ochranná známka dodavatele	Meno dodávateľa alebo jeho ochranná známka	A szállító neve vagy védjegye	Nazwa dostawcy lub znak towarowy
	Adresa dodavatele	Adresa dodávateľa	A szállító címe	Adres dostawcy
2	Identifikační značka modelu	Identifikačný kód modelu	modellazonosító	Identyfikator modelu
3	Třída energetické účinnosti u standardního dynamického rozsahu (SDR)	Trieda energetickej účinnosti pre štandardný dynamický rozsah (SDR)	Energiahatékonysági osztály szabványos dinamikatartomány (SDR) esetében	Klasa efektywności energetycznej dla standardowego zakresu dynamicznego (SDR)
4	Příkon v zapnutém stavu v SDR	Příkon v režime zapnutia pre SDR	A bekapcsolt üzemmód energiaigénye szabványos dinamikatartomány (SDR) esetében	Pobór mocy w trybie włączenia dla SDR
5	Třída energetické účinnosti v režimu vysoce dynamického rozsahu (HDR)	Trieda energetickej účinnosti pre vysoký dynamický rozsah (HDR)	Energiahatékonysági osztály nagy dinamikatartomány (HDR) esetében	Klasa efektywności energetycznej dla szerokiego zakresu dynamicznego (HDR)
6	Příkon v zapnutém stavu v HDR, je-li k dispozici	Příkon v režime zapnutia pre HDR, ak je k dispozícii	A bekapcsolt üzemmód energiaigénye nagy dinamikatartomány (HDR) megléte esetén	Pobór mocy w trybie włączenia dla HDR
7	Vypnutý stav, příkon (v příslušných případech)	Příkon v režime vypnutia, ak j ek dispozícii	Energiaigény Kikapcsolt üzemmódban, (adott esetben)	Pobór mocy w trybie wyłączenia, w stosownych przypadkach
8	Příkon v pohotovostním režimu (v příslušných případech)	Příkon v režime pohotovosti, ak j ek dispozícii	Energiaigény Készenléti üzemmódban, (adott esetben)	Pobór mocy w trybie czuwania, w stosownych przypadkach
9	Příkon v pohotovostním režimu při připojení na síť (v příslušných případech)	Příkon v režime pohotovosti pri zapojení v sieti ak j ek dispozícii	Energiaigény hálózatzvezérelt készenléti üzemmódban, (adott esetben)	Pobór mocy w trybie czuwania przy podłączeniu do sieci, w stosownych przypadkach
10	Kategorie elektronického displeje	Kategória elektronického displeja	Elektronikus kijelző kategóriája	Kategoria wyświetlacza elektronicznego
11	Poměr stran	Pomer strán	Képarány	Format obrazu
12	Rozlišení obrazovky	Rozlíšenie obrazovky	Képernyőfelbontás	Rozdzielczość ekranu
13	Úhlopříčka obrazovky	Uhlopriečka zobrazovacej jednotky	Képtáv	Przekątna ekranu
14	Úhlopříčka obrazovky	Uhlopriečka zobrazovacej jednotky	Képtáv	Przekątna ekranu
15	Viditelná plocha obrazovky	Viditeľná plocha zobrazovacej jednotky	Látható kijelzőfelület	Widoczna powierzchnia ekranu
16	Použitá technologie panelů	Použitá technológia panelu	Alkalmazott paneltechnológia	Zastosowana technologia panelu
17	Dostupné automatické ovládání jasu (ABC)	K dispozícii je automatická regulácia jasu (ABC)	Automatikus fényerőszabályozó (ABC) rendelkezésre áll	Dostępność funkcji automatycznej regulacji jasności (ABC)
18	Dostupný snímač pro rozpoznávání hlasu	K dispozícii je snímač rozpoznávania reči	Hangfelismerő érzékelő rendelkezésre áll	Dostępność czujnika rozpoznawania mowy
19	Dostupný detektor přítomnosti v místnosti	K dispozícii je snímač prítomnosti v miestnosti	Jelenlétérzékelő rendelkezésre áll	Dostępność czujników obecności w pomieszczeniu
20	Obnovovací frekvence obrazu (výchozí)	Obnovovací kmitočet obrazovky (predvolený)	Képfriessítési frekvencia (alapértelmezett)	Częstotliwość odświeżania obrazu (domyślna)
21	Minimální zaručená dostupnost aktualizací softwaru a firmwaru (od date, kdy bylo ukončeno uvádění na trh)	Minimálna zaručená dostupnosť aktualizácií softvéru a firmvéru (od dátumu keď sa výrobok prestáva dodávať na trh)	A szoftver- és firmware-frissítések minimális garantált rendelkezésre állása (a forgalomba hozatal befejezésének időpontjától számítva)	Minimalna gwarantowana dostępność aktualizacji oprogramowania i oprogramowania układowego (od daty zakończenia wprowadzania do obrotu)
22	Minimální zaručená dostupnost náhradních dílů (od date, kdy bylo ukončeno uvádění na trh)	Minimálna zaručená dostupnosť náhradných dielov (od dátumu keď sa výrobok prestáva dodávať na trh)	A tartalék alkatrészek minimális garantált rendelkezésre állása (a forgalomba hozatal befejezésének időpontjától számítva)	Minimalna gwarantowana dostępność części zamiennych (od daty zakończenia wprowadzania do obrotu)

#	CZ	SK	HU	PL	
23	Minimální zaručená podpora výrobku	Minimálna zaručená podpora výrobkov	Garantált terméktámogatás minimális időtartama	Minimalne gwarantowane serwisowane produktu	
	Minimální doba trvání obecné záruky nabízená dodavatelem	Minimálne trvanie celkovej záruky, ktorú ponúka dodávateľ	A szállító által vállalt általános jótállás minimális időtartama	Minimalny okres ogólnej gwarancji oferowanej przez dostawcę	
24	Typ napájení	Typ zdroja napájania	A tápegység típusa	Typ zasilacza	
25	Vnější napájecí zdroj (jiný než normalizovaný a součást balení výrobku)	Externý zdroj napájania (nenormalizovaný, súčasť balenia výrobku)	külső tápegység (nem szabványos, és a termékdobozban található)	zasilacz zewnętrzny (nieznormalizowany i dostarczony w opakowaniu z produktem)	
	i	-	-	-	
	ii	Vstupní napětí	Vstupné napätie	Bemeneti feszültség	Napięcie wejściowe
	iii	Výstupní napětí	Výstupné napätie	Kimeneti feszültség	Napięcie wyjściowe
26	Vnější normalizovaný napájecí zdroj (nebo vhodný zdroj tohoto typu, pokud není součástí balení výrobku)	Externý normalizovaný zdroj napájania (alebo vhodný zdroj, ak nie je súčasťou balenia výrobku)	szabványos külső tápegység (vagy annak megfelelő, ha a termékdoboznak nem része)	znormalizowany zasilacz zewnętrzny (lub odpowiedni zasilacz, jeżeli nie jest dostarczony w opakowaniu z produktem)	
	i	-	-	-	
	ii	Požadované výstupní napětí	Požadované výstupné napätie	Előírt kimeneti feszültség	Wymagane napięcie wyjściowe
	iii	Požadovaný dodávaný proud (minimální)	Požadovaný prúd (minimálny)	Előírt szállított áramerősség (minimum)	Wymagane natężenie prądu (minimalne)
	iv	Požadovaný kmitočet proudu	Požadovaná frekvencia prúdu	Előírt áramfrekvencia	Wymagana częstotliwość prądu