

SEARS

Operator's Manual

- Assembly
- Operation
- Maintenance
- Repair Parts

MODEL NO.

358.356281-2.8/18"

358.356332-3.3/20"

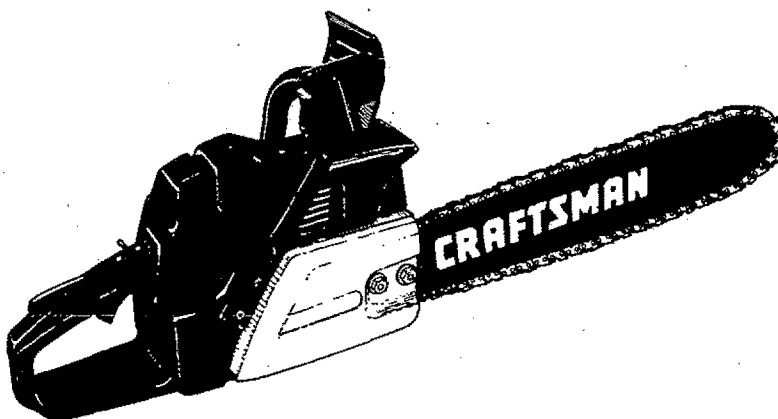

SEARS / CRAFTSMAN®

2.8/18"

3.3/20"

GASOLINE CHAIN SAW



▲WARNING:

Carefully read and follow Safety Rules, Precautions and Operating Instructions. Failure to do so can result in serious personal injury.

Record in the space provided below the Model No. and Serial No. of your saw. These numbers are located on the starting instructions decal.

Model No. _____ Serial No. _____

Retain these numbers for future reference.

Sold by Sears, Roebuck and Co., Hoffman Estates, IL 60179 USA

FULL ONE YEAR WARRANTY ON GASOLINE CHAIN SAW

(Excluding Bar, Chain, Spark Plug, Air Filter and Starter Rope)

For one year from date of purchase, when you maintain, lubricate, and tune up this chain saw according to the operating and maintenance instructions in the operator's manual, Sears will repair defects in material or workmanship in this gasoline chain saw at no charge. This warranty excludes bar, chain, spark plug, air filter, and starter rope which are expendable parts and become worn during normal use.

If this chain saw is used for commercial or rental purposes, this warranty does not apply.

WARRANTY SERVICE IS AVAILABLE BY RETURNING THE CHAIN SAW TO THE NEAREST SEARS SERVICE CENTER/DEPARTMENT IN THE UNITED STATES.

This warranty gives you specific legal rights, and you may also have other rights which vary from state to state.

Sears, Roebuck and Co., Dept. D/731-CR-W, Sears Tower, Chicago, IL 60684

Sold by Sears, Roebuck and Co., Dept. D/817WA, Hoffman Estates, IL 60179 USA

TABLE OF CONTENTS

Specifications	2	Using Your Saw	11
SPECIAL SAFETY SECTION	3	Types of Cutting	12
Know Your Chain Saw	6	Maintenance	16
Preparing Your Saw For Use	7	Repair Parts	23
Accessories	10	Quick Reference Page	27

SPECIFICATIONS

MODEL	358356281 (2.8/18")	358358332 (3.3/20")
CU. IN. DISPLACEMENT	2.8 in. ³	3.3 in. ³
GUIDE BAR—REDUCED-KICKBACK	18" Lo-Kick® Guide Bar Stock No. 71-36372	20" Lo-Kick® Guide Bar Stock No. 71-36373
CHAIN LOW-KICKBACK	18" - .325 Extended Pitch Chrome Cutters - 72 Drive Links - Stock No. 71-3634	20" - .325 Extended Pitch Chrome Cutters - 78 Drive Links — Stock No. 71-3635
SPARK PLUG	Champion CJ-4 (Stock No. 71-36401)	
SPARK PLUG GAP	.025"	
IGNITION	Solid State	
MODULE AIR GAP	.008 to .014"	
FUEL MIX	Gasoline/Oil Mixture 40:1	
MUFFLER	Spark Arresting/Temperature Limiting USDA Approved	
OILER SYSTEM	Adjustable Automatic	
FUEL TANK CAPACITY	20 oz.	
OIL TANK CAPACITY	10 oz.	

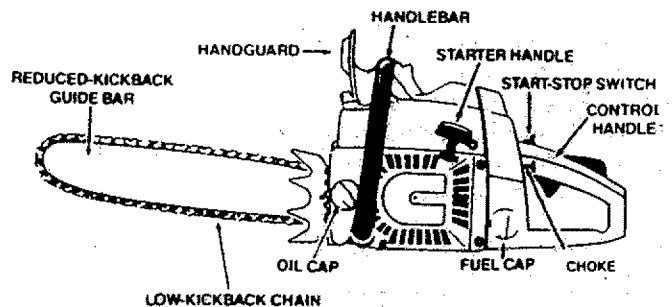
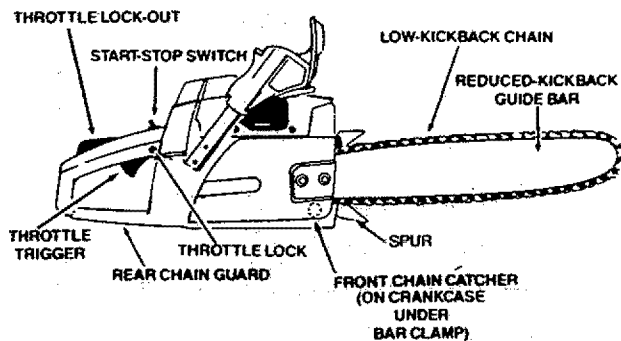

SPECIAL SAFETY SECTION

GUARD AGAINST KICKBACK

Kickback is a dangerous reaction that can lead to serious personal injury. Do not rely only on the safety devices provided with your saw. As a chain saw user, you must take special safety precautions to help keep your cutting jobs free from accident or injury.

⚠ KICKBACK WARNING

Kickback can occur when the moving chain contacts an object at the upper portion of the tip of the guide bar or when the wood closes in and pinches the saw chain in the cut. Contact at the upper portion of the tip of the guide bar can cause the chain to dig into the object and stop the chain for an instant. The result is a lightning fast, reverse reaction which kicks the guide bar up and back toward the operator. If the saw chain is pinched along the top of the guide bar, the guide bar can be driven rapidly back toward the operator. Either of these reactions can cause loss of saw control which can result in serious injury.

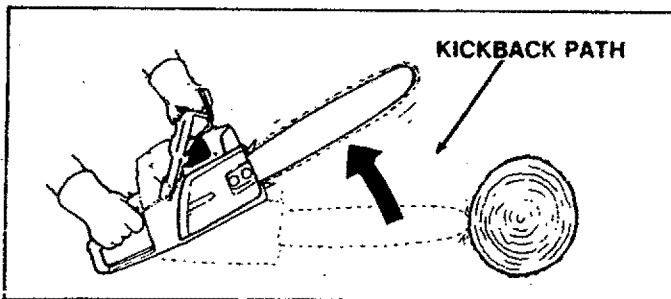

Figure 1

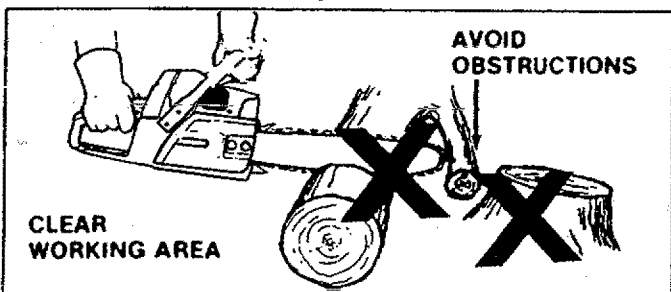

Figure 2

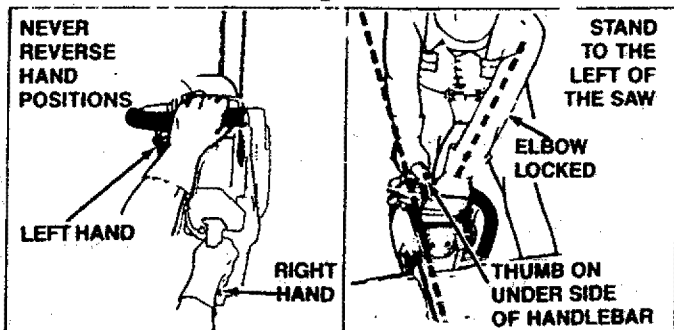

Figure 3

REDUCING KICKBACK

1. Recognize that kickback can happen. With a basic understanding of kickback, you can reduce the element of surprise which contributes to accidents.
2. **Never let the moving chain contact any object at the tip of the guide bar.** Figure 1.
3. Keep the working area free from obstructions such as other trees, branches, rocks, fences, stumps, etc. Figure 2. Eliminate or avoid any obstruction that your saw chain could hit while you are cutting through a particular log or branch.
4. Keep your saw chain sharp and properly tensioned. Follow Sears chain sharpening and maintenance instructions. Check tension at regular intervals with the engine stopped, never with the engine running. Make sure the bar clamp nuts are securely tightened after tensioning the chain. A loose or dull chain can increase the chance of kickback.
5. Begin and continue cutting at full throttle. If the chain is moving at a slower speed, there is greater chance for kickback.
6. Cut only one log at a time.
7. Use extreme caution when re-entering a cut.
8. Do not attempt plunge cuts.
9. Watch for shifting logs or other forces that could close a cut and pinch or fall into the chain.
10. Use only the Reduced-Kickback Guide Bar and Low-Kickback Chain specified for your saw.

MAINTAINING CONTROL

1. Keep a good firm grip on the saw with both hands when the engine is running and don't let go. Figure 3. A firm grip can neutralize kickback and help you maintain control of the saw. Keep the fingers of your left hand encircling and your left thumb under the front handlebar. Keep your right hand completely around the rear handle *whether you are right handed or left handed*. Keep your left arm straight with the elbow locked.
2. Position your left hand on the front handlebar so it is in a straight line with your right hand on the rear handle when making bucking cuts. Figure 3. Never reverse right and left hand positions for any type of cutting.
3. Stand with your weight evenly balanced on both feet.
4. Stand slightly to the left side of the saw to keep your body and head from being in a direct line with the cutting chain. Figure 3.
5. Do not overreach. You could be drawn or thrown off balance and lose control of the saw.
6. Never cut above shoulder height. It is difficult to maintain control of the saw above shoulder height and places the chain dangerously close to your upper body.

SPECIAL SAFETY SECTION (continued)

⚠ WARNING

Because a chain saw is a high-speed wood-cutting tool, special safety precautions must be observed to reduce the risk of accidents. Careless or improper use can cause serious injury.

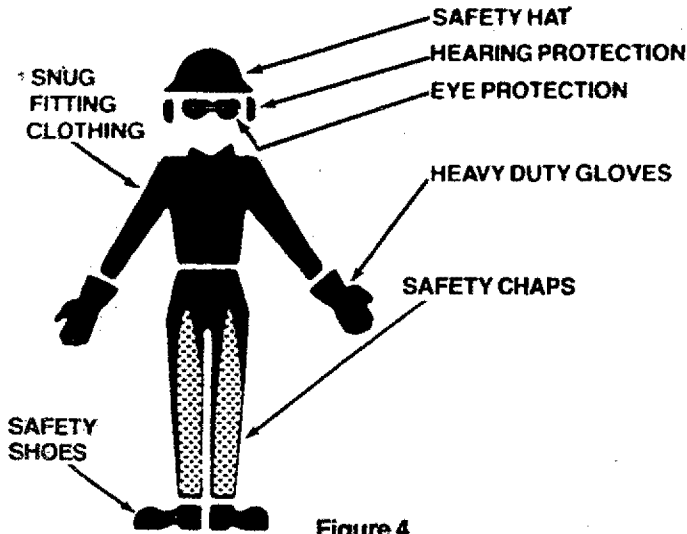

Figure 4

KNOW YOUR SAW

1. Read your Operator's Manual carefully until you completely understand and follow all safety rules and operating instructions before attempting to operate the unit.
2. Restrict the use of your saw to adult users who understand and follow the safety rules, precautions, and operating instructions in this manual.

PLAN AHEAD

1. Wear protective gear. Figure 4. Always use steel-toed safety footwear with non-slip soles; snug-fitting clothing; heavy-duty non-slip gloves; eye protection such as non-fogging, vented goggles or face screen; an approved safety hard hat, and sound barriers — ear plugs or mufflers to protect your hearing. Regular users should have hearing checked regularly as chain saw noise can damage hearing.
2. Keep children, bystanders, and pets out of the work area — a minimum of 30 feet (10 meters). Do not allow other people or animals to be near the chain saw when starting or operating the chain saw.
3. Do not handle or operate a chain saw when you are fatigued, ill, upset, or if you are under the influence of alcohol, drugs, or medication. You must be in good physical condition and mentally alert. Chain saw work is strenuous. If you have any condition that might be aggravated by strenuous work, check with your doctor before operating a chain saw.

4. Do not attempt to use your chain saw during bad weather conditions such as strong wind, rain, snow, etc., or at night.
5. Plan your sawing operation carefully in advance. Do not start cutting until you have a clear work area, secure footing, and if you are felling trees, a planned retreat path.

AVOID REACTIVE FORCES

Pinch-Kickback and Pull-in occur when the chain is suddenly stopped by being pinched, caught, or by contacting a foreign object in the wood. This results in a reversal of the chain force used to cut wood and causes the saw to move in the opposite direction of chain rotation. Pinch-Kickback drives the saw straight back toward the operator. Pull-in pulls the saw away from the operator. Either reaction can result in loss of control and possible serious injury.

To avoid Pinch-Kickback:

1. Be extremely aware of situations or obstructions that can cause material to pinch the top of or otherwise stop the chain.
2. Do not cut more than one log at a time.
3. Do not twist the saw as the bar is withdrawn from an under-cut when bucking.

To avoid Pull-in:

1. Always begin cutting with the engine at full throttle and the spur against the wood.
2. Use wedges made of plastic or wood (never of metal) to hold the cut open.

HANDLE FUEL WITH CAUTION

1. Eliminate all sources of sparks or flame in the areas where fuel is mixed, poured, or stored. There should be no smoking, open flames, or work that could cause sparks.
2. Mix and pour fuel in an outdoor area, on bare ground; store fuel in a cool, dry, well-ventilated place; and use an approved, marked container for fuel.
3. Wipe up all spilled fuel before starting your saw.
4. Move at least 10 feet (3 meters) away from fuel and fueling site before starting the engine.
5. Do not smoke while handling fuel or while operating the saw.
6. Turn the engine off and let your saw cool in a non-combustible area, not on dry leaves, straw, paper, etc.
7. Stop engine before removing fuel cap. Allow the engine to cool before refueling.
8. Store tool and fuel in an area where fuel vapors cannot reach sparks or open flames from water heaters, electric motors or switches, furnaces, etc.

To avoid the above listed situations, refer to the "Types of Cutting" section.

SPECIAL SAFETY SECTION (continued)

OPERATE YOUR SAW SAFELY

1. Do not operate a chain saw that is damaged, improperly adjusted, or not completely and securely assembled.
2. Operate the chain saw only in outdoor areas.
3. Do not operate the saw from a ladder or in a tree.
4. Position all parts of your body to the left of cut and away from the saw chain when the engine is running.
5. Cut wood only. Do not cut metal, plastics, masonry, non-wood building materials, etc. Inspect material to be cut; remove any foreign materials such as nails, wire, etc. Do not use your saw to pry or shove away limbs, roots, or other objects.
6. Make sure the chain will not make contact with any object before starting the motor. Never try to start the saw when the guide bar is in a cut.
7. Use extreme caution when cutting small size brush and saplings. Slender material can catch the saw chain and be whipped toward you or pull you off balance.
8. Be alert for springback when cutting a limb that is under tension so you will not be struck by the limb or saw when the tension in the wood fibers is released.
9. Do not put pressure on the saw at the end of a cut. This can cause you to lose control when the cut is completed.
10. Stop the engine before setting the saw down.

MAINTAIN YOUR SAW IN GOOD WORKING ORDER

1. Have all chain saw service performed by your Sears Service Center/Department with the exception of the items listed in the maintenance section of this manual. For example, if improper tools are used to remove or hold the flywheel when servicing the clutch, structural damage to the flywheel can occur and cause the flywheel to burst.
2. Keep fuel and oil caps, screws, and fasteners securely tightened.
3. Keep the handles dry, clean, and free of oil or fuel mixture.
4. Make certain the saw chain stops moving when the throttle trigger is released. For correction, refer to "Carburetor Adjustment" instructions.
5. Stop the saw if the chain strikes a foreign object. Check for alignment, binding, breakage, and mounting of moving parts and any other condition that may affect the operation of the unit. Check guards and all other parts to see if each will operate properly and perform its intended function. Any part that is damaged should be properly repaired or replaced by using the instructions in this manual or by seeing your Sears Service Center.
6. Disconnect the spark plug before performing any maintenance except for carburetor adjustments.

NOTE: When cutting fibrous material such as palms, pampas grass, yucca, etc., clean the cooling system (including cylinder cooling fins) after every other refueling.

7. Never modify your saw in any way. Use only attachments supplied or specifically recommended by Sears.
8. Always replace the handguard immediately if it becomes damaged, broken, or is otherwise removed.
9. Keep the vibration isolators in good condition. Periodically inspect isolators for tears, rips, or separation of the rubber portion from the metal mountings. Have your Sears Service Center/Department replace the isolators if worn or damaged, if vibration increases, or if mounts develop an out of round or swollen shape from exposure to gasoline and/or oil. It is recommended that all isolators be replaced when a failure to one occurs.

CARRY AND STORE YOUR SAW SAFELY

1. Hand carry the unit with the engine stopped, the muffler away from your body, and the guide bar and chain to the rear covered preferably with a scabbard.
2. Before transporting in any vehicle or storing in any enclosure, allow your saw to cool completely, cover the bar and chain, and properly secure to avoid turnover, fuel spillage, or damage.
3. Before storing the tool, use up fuel left in the carburetor and fuel lines by starting the engine and letting it run until it stops.
4. Store in a dry area out of the reach of children and away from where fuel vapors can reach sparks or an open flame from hot water heaters, furnaces, etc.

SAVE THESE INSTRUCTIONS

NOTE: Exposure to vibrations through prolonged use of gasoline powered hand tools could cause blood vessel or nerve damage in the fingers, hands, and wrists of people prone to circulation disorders or abnormal swellings. Prolonged use in cold weather has been linked to blood vessel damage in otherwise healthy people. If symptoms occur such as numbness, pain, loss of strength, change in skin color or texture, or loss of feeling in the fingers, hands, or wrists, discontinue the use of this tool and seek medical attention. An anti-vibration system does not guarantee the avoidance of these problems. Users who operate power tools on a continual and regular basis must monitor closely their physical condition and the condition of this tool.

Notice: Refer to the Code of Federal Regulations, Section 1910.266(5); 2.5.1 of American National Standard Safety Requirements for Pulpwood Logging, ANSI O3.1-1978; and relevant state safety codes when using a chain saw for logging purposes.

KNOW YOUR CHAIN SAW

A. INTRODUCTION

Your saw has been designed with safety in mind and includes the following features as standard equipment:

- Reduced-Kickback Guide Bar (Lo-Kick®)
- Low-Kickback Chain (Elongated Guard Link)
- Spark Arrestor
- Temperature Limiting Muffler
- Handguards
- Full Vibration Isolation System

⚠ WARNING

The following features are included on your saw to help reduce the hazard of kickback; however, such features will not totally eliminate this dangerous reaction. As a chain saw user, do not rely only on safety devices. You must follow all safety precautions, instructions, and maintenance in this manual to help avoid kickback and other forces which can result in serious injury.

B. KICKBACK SAFETY FEATURES

- **Reduced-Kickback Guide Bar**, designed with a small radius tip which reduces the size of the kickback danger zone on the bar tip. Figure 5. A Reduced-Kickback Guide Bar is one which has been demonstrated to significantly reduce the number and seriousness of kickbacks when tested in accordance with the safety requirements for gasoline powered chain saws as set by the American National Standards Institute, Inc., Standard B175.1-1985.
- **Low-Kickback Chain**, designed with a contoured depth gauge and guard link which deflect the kickback force and allow wood to gradually ride into the cutter. Figure 5. Low-Kickback Saw Chain is chain which has met the kickback performance requirements of ANSI B175.1 when tested on a representative sample of chain saws below 3.8 cubic inch displacement specified in ANSI B175.1-1985. (American National Standard for Power Tools - Gasoline Powered Chain Saws - Safety Requirements).
- **Handguard**, designed to reduce the chance of your left hand contacting the chain if your hand slips off the front handlebar.
- **Position of front and rear handlebars**, designed with distance between handles and "in line" with each other. The spread and "in line" position of the handlebars work together to give balance and resistance in controlling the saw if kickback occurs.

⚠ WARNING

Do not operate the chain saw unless the safety devices or their specified replacements are properly installed and maintained according to the instructions in this manual. Do not use any other guide bar and chain combination that is not equivalent to the original equipment or not certified to comply with ANSI B175.1-1985. Failure to follow these instructions can result in serious injury.

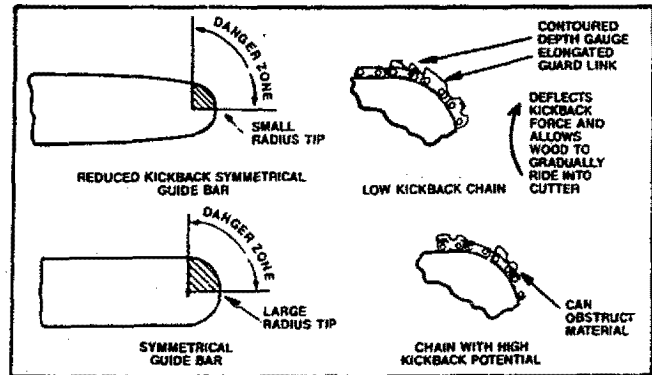

Figure 5

C. STATE AND LOCAL REQUIREMENTS.

For users on U.S. Forest Land and in some states, including California (Public Resources Codes 4442 and 4443), Idaho, Maine, Minnesota, New Jersey, Oregon, and Washington: Certain internal combustion engines operated on forest, brush, and/or grass-covered lands in the above areas, must be equipped with a spark arrestor, maintained in effective working order, or the engine must be constructed, equipped, and maintained for the prevention of fire. Check with your state or local authorities for regulations pertaining to these requirements. Failure to follow these requirements is a violation of the law. **This unit is factory-equipped with a spark arrestor.** If a spark arrestor is required in your area, you are legally responsible for maintaining the operating condition of these parts (see "Spark Arrestor" in the maintenance section).

D. CARTON CONTENTS

After you unpack the carton:

1. Check the contents against the list below.
2. Examine the items for damage.
3. *Notify your Sears Store immediately if a part is missing or damaged.*

NOTE: It is normal to hear the fuel filter rattle in an empty fuel tank.

KEY NO.	CARTON CONTENTS:	QTY.
1	Power Head	1
2	Guide Bar	1
3	2-Cycle Engine Oil	1
—	Loose Parts Bag (not shown)	1
LOOSE PARTS BAG CONTENTS:		
4	Handguard	1
5	Cap-Handguard	1
6	Screws - Handguard (#10 x 1")	3
7	Spur	1
8	Screw - Spur (#10 - 24 x 5/8")	2
9	Chain	1
10	Scrench	1
—	Operator's Manual (not shown)	1

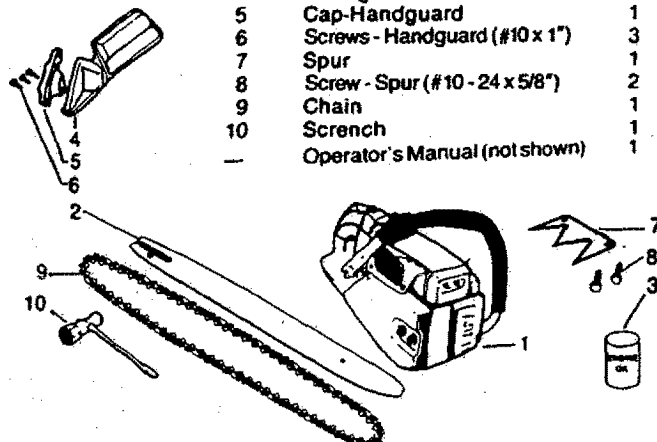

PREPARING YOUR SAW FOR USE

A. GETTING READY

1. READ YOUR OPERATOR'S MANUAL

Your Operator's Manual has been developed to help you prepare your saw for use and to understand its safe operation. It is important that you read your manual completely to become familiar with the unit *before* you begin assembly or attempt operation.

2. HAVE THE FOLLOWING AVAILABLE:

- Protective gloves
- Approved, marked, fuel container.
- Regular unleaded gasoline. (See "Fueling Your Engine.")
- Two-cycle engine oil provided with unit.
- Bar and Chain Lubricant. (See "Bar and Chain Lubricant.")
- Srench — provided with your unit. Use the long end of the tool as a standard screwdriver, the small pipe end as a socket wrench, and the larger pipe end to remove the spark plug.
- Phillips Screwdriver.

B. ATTACHING THE HANDGUARD

The Handguard is a protective device designed to reduce the chance of your left hand contacting the chain if your hand slips off the front handlebar.

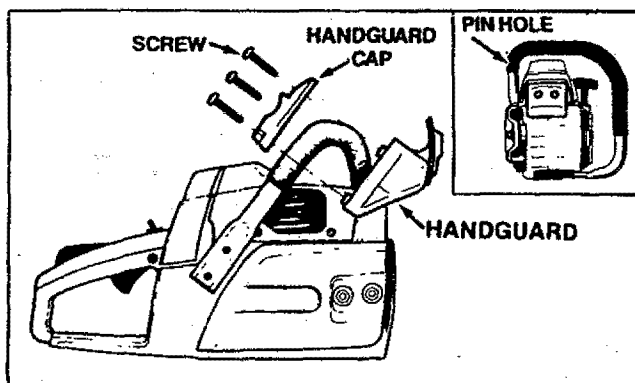

Figure 6

⚠ WARNING

Do not use the saw without the handguard in place. Always replace the handguard immediately if it becomes damaged, broken, or otherwise removed.

- Lift and carry the chain saw by the handlebar, *not* by the handguard.
- Keep the handguard securely fastened at all times. Check the handguard screws each time the saw is used.
- To install:
 1. Align the Handguard and Handguard Cap around the Handlebar as shown in Figure 6.
 2. Fit the mounting pin on the Handguard into the pin hole in the Handlebar. Figure 6 (inset).
 3. Insert the 3 mounting screws into the 3 holes on the Handguard Cap.
 4. Turn each screw with a Phillips screwdriver a little at a time clockwise until the Handguard Cap and Handguard meet and there is no gap between the two parts.

C. ATTACHING THE SPUR

- The spur is a special piece of equipment designed to assist the cutting operation. When assembled to the saw, the spur will dig into the tree or log and:

- relieve contact pressure adding ease to the sawing operation.
- allow the saw to be more easily rotated or pivoted into the cut.

- To Install:

1. Remove the bar clamp nuts and bar clamp.
NOTE: Be sure to remove the spacer on the bar stud (between the bar clamp and the crankcase).
2. Remove the front screw and spacer from the chain catcher bracket. Figure 7 (inset). Discard the spacer.
3. Position the spur over the two holes in the shroud. Figure 7. Make sure the lower screw hole on the spur is positioned *between* the shroud and the chain catcher bracket. Figure 7.

4. Secure the spur with the new screw (supplied) and the screw removed in step 2. Tighten the screws firmly.

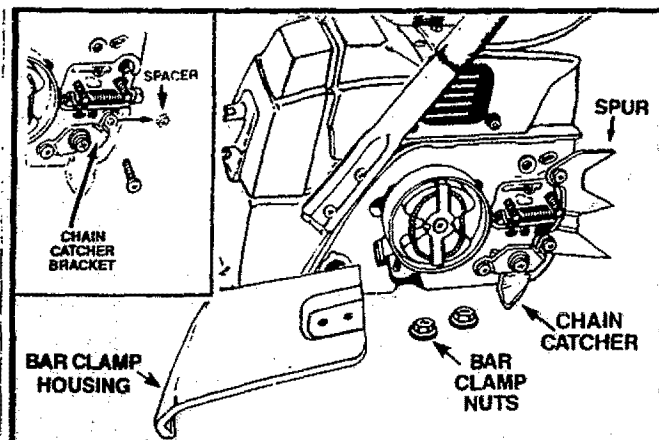

Figure 7

D. ATTACHING THE BAR AND CHAIN

CAUTION: Wear protective gloves when handling or operating your saw. The chain is sharp and can cut you even when it is not moving!

- Your saw is equipped with a Reduced-Kickback Guide Bar and a Low-Kickback Chain.
- Use only the Reduced-Kickback Guide Bar and Low-Kickback Chain specified for your chain saw model when replacing these parts. See "Specifications."

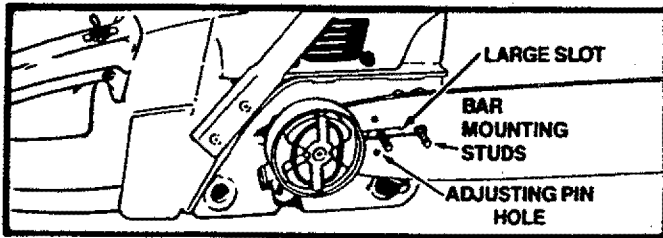

Figure 8

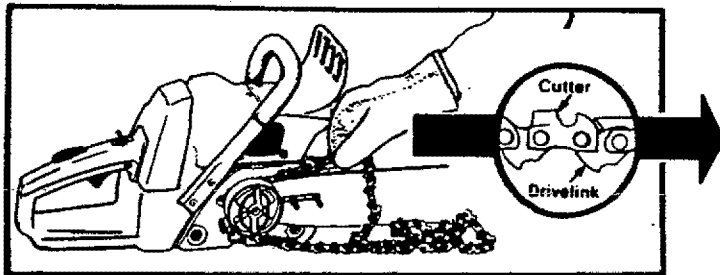

Figure 9

WARNING

Do not start engine without guide bar and chain completely assembled. Otherwise, the clutch can come off and serious injury can result.

1. Turn the adjusting screw counterclockwise to move the adjusting pin almost as far as it will go to the rear. Figure 10.
2. Mount the slotted end of the guide bar over the bar mounting studs and the small round hole over the adjusting pin. Figure 8. Turn the adjusting screw as needed to position the adjusting pin.
3. Hold chain with cutters facing as shown in Figure 9.
4. Place chain over and behind the clutch drum onto the sprocket. Fit the bottom of the drive links between the teeth in the sprocket.
5. Start at the top of the bar and fit the chain drive links into the groove around the guide bar. Figure 9.
6. Turn the adjusting screw clockwise until the chain is snug in the guide bar groove. Figure 10.
7. Install the bar clamp, replace the bar clamp nuts, then tighten the nuts finger tight *only*.
8. Follow "Chain Tension" instructions below.

E. CHAIN TENSION

- Correct chain tension is very important:
 - a loose chain will wear the bar and itself.
 - a loose chain can jump off the bar while you are cutting.
 - a tight chain can damage the saw and/or break.
- The chain stretches during use, especially when new. Check tension:
 - each time the saw is used
 - more frequently when the chain is new
 - as the chain warms up to normal operating temperature
- Chain tensioning procedure:

NOTE: The bar clamp nuts must be no more than finger tight to tension the chain correctly.

NOTE: Hold up the tip of the Guide Bar through step 4.

1. Hold the tip of the guide bar up and turn the adjusting screw just until the chain does not sag beneath the guide bar. Figure 10.

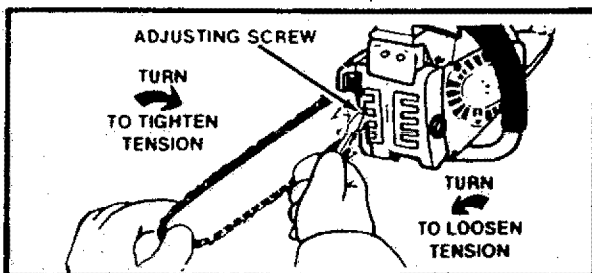

Figure 10

NOTE: Turn screw clockwise to tighten tension. Turn screw counterclockwise to loosen tension.

2. While still holding the tip of the guide bar up check the tension by lifting the chain from the guide bar at the center of the bar. Figure 11.

NOTE: Chain tension is correct when the chain:

- can be lifted about 1/8" from the Guide Bar at a point near the middle of the bar,
- and will move freely around the bar.

When installing a new chain, allow the chain to be lifted 1/4" from the bar. Thereafter, follow the instructions as indicated.

3. Continue adjusting the Adjusting Screw until the tension is correct.
4. Hold the tip of the Guide Bar up and tighten the Bar Clamp Nut with the Bar Adjusting Tool.
5. Recheck tension. See Figure 11.

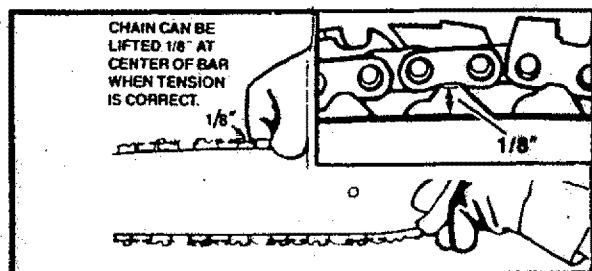

Figure 11

F. FUELING YOUR ENGINE

1. FUEL SAFETY

- a. Use only recommended fuel mixtures.
- b. Mix and pour fuel outdoors and where there are no sparks or flames.
- c. Use a container approved for fuel.
- d. Do not smoke or allow smoking near fuel or the tool or while using the tool.
- e. Wipe up all fuel spills before starting engine.
- f. Move at least 10 feet away from fueling site before starting engine.
- g. Stop engine before removing fuel cap. Allow the engine to cool before refueling.
- h. Before storing the tool, use up fuel left in the carburetor and fuel lines by starting the engine and letting it run until it stops.
- i. Store tool and fuel in an area where fuel vapors cannot reach sparks or open flames from water heaters, electric motors or switches, furnaces, etc.

2. FUEL MIXTURE

- Your tool is powered by a two-cycle engine which requires a fuel mixture of regular unleaded gasoline and a high quality engine oil specially made for 2-cycle, air cooled engines. The internal design of the 2-cycle engine requires lubrication of moving parts. Lubrication is provided when the recommended mixture of gasoline and oil is used.
- Gasoline must be clean and not over two months old. Gasoline will chemically break down and form compounds that cause hard starting and damage in 2-cycle engines.
- The correct measure of gasoline to oil is very important. Too much oil in the mixture will foul the spark plug.

CAUTION: Too little oil or incorrect oil will cause the engine to overheat and seize.

- Always mix the fuel thoroughly in a container since gasoline and oil do not readily combine. Do not mix gasoline and oil directly in the fuel tank.

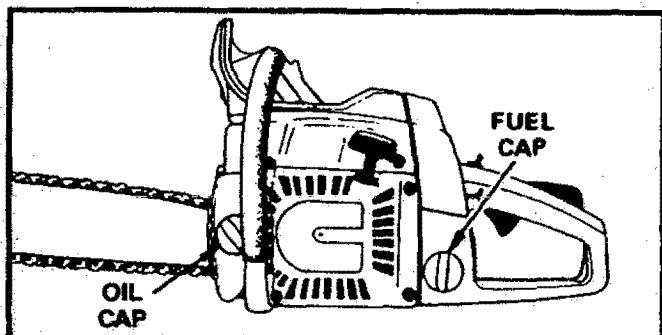

Figure 12

3. USE THE FOLLOWING ONLY:

SEARS CRAFTSMAN 2-CYCLE ENGINE OIL MIXED AT 40:1 IS STRONGLY RECOMMENDED. CONSULT THE INSTRUCTIONS ON THE OIL CONTAINER FOR PROPER MIXING.

1 Part Oil to 40 Parts Gasoline =
3.2 Fl Oz Oil to 1 Gallon Gasoline
8.0 Fl Oz Oil to 2.5 Gallon Gasoline

Not all air-cooled engine oils have the same qualities. If Sears Craftsman 2-cycle engine oil is not available, use a good quality, 2-cycle engine oil recommended for air-cooled engines. Mix at a ratio of 16:1 (8 oz. oil to 1 gallon gasoline). A 16:1 fuel mixture with these oils will assure adequate lubrication for your engine.

4. DO NOT USE:

- **NMMA Oil** — National Marine Manufacturers Association (formerly BIA)

Does not have proper additives for 2-cycle, air-cooled engines and can cause engine damage.

- **AUTOMOTIVE OIL** —

Does not have proper additives for 2-cycle, air-cooled engines and can cause engine damage.

⚠ CAUTION

Experience indicates that alcohol blended fuels (called gasohol or using ethanol or methanol) can attract moisture which leads to separation and formation of acids during storage. Acidic gas can damage the fuel system of an engine while in storage. To avoid engine problems, do not leave fuel in the unit when storing for 30 days or longer. Start the engine and let it run until the fuel lines and carburetor are empty. Use fresh fuel next season. See the "Storage" section for additional information. Never use engine or carburetor cleaner products in the fuel tank or permanent damage can occur.

NOTE: If you do not want to remove the gasoline from your unit, SEARS CRAFTSMAN Fuel Stabilizer (#71-33500) may be added to gasoline left in the tank to minimize gum deposits and acids. If the tank is almost empty, mix stabilizer with fresh gasoline in a separate container and add to the tank.

5. HOW TO MIX FUEL AND FILL TANK

- a. Pour the proper measure of engine oil into an approved, marked container. Then, fill the container with regular unleaded gasoline.

NOTE: If fuel is already in the container, add the proper measure of engine oil. Then, close the container tightly and shake it momentarily.

NOTE: Do not mix gasoline and oil directly in the fuel tank.

- b. Using a spout or funnel, fill the fuel tank with fuel mix.
- c. Reinstall the fuel cap securely.

G. BAR AND CHAIN LUBRICANT

- The Guide Bar and Cutting chain require continuous lubrication to remain in operating condition. Lubrication is provided by the automatic oiler system when the oil tank is kept filled.
 - Lack of oil will quickly ruin the bar and chain.
 - Too little oil will cause overheating shown by smoke coming from the chain and/or discoloration of the guide bar rails.
- Use Sears Bar and Chain Lubricant (#71-36554-gal. or #71-36556-qt.) to fill the oil tank. Clean SAE 30W oil may also be used, but is less effective. *Never use waste oil for this purpose.*
- In freezing weather oil will thicken, making it necessary to thin bar and chain oil with a small amount of #1 Diesel Fuel or Kerosene. Bar and chain oil must be free flowing for adequate lubrication.

1. USE THE FOLLOWING:

- 30° or above — Lubricant undiluted
30° to 0°F. — 95% Lubricant to 5%
 #1 Diesel fuel or Kerosene.
Below 0°F. — 90% Lubricant to 10%
 #1 Diesel fuel or Kerosene.

2. HOW TO FILL THE OIL TANK

- Stop the engine.
- Turn saw on its side with oil cap up. Figure 12.
- Loosen cap slowly and wait for pressure in the tank to be released before removing the cap.
- Fill the oil tank.
- Replace the oil cap securely.

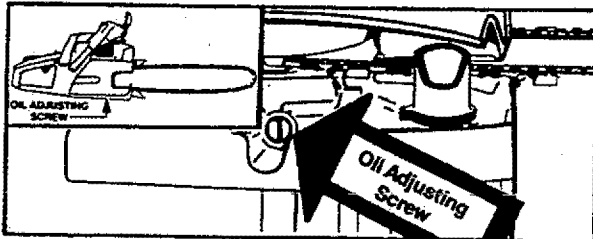

Figure 13

3. ADJUSTING THE AUTOMATIC OILER

- The adjustable automatic oiler is set for maximum output at the factory. Some types of cutting will require adjusting the oiler.
 - less oil is required for soft or freshly cut wood.
 - maximum oil is required for hardwood or wood that has been cut for a period of time.
- The adjusting screw is located at the bottom of the saw on the crankcase next to the bar clamp housing and can be adjusted with the screwdriver end of the srench provided with your saw. Figure 13.
 - To increase the oil flow, turn the adjusting screw counterclockwise.
 - To decrease the oil flow, turn the adjusting screw clockwise.
- If the oiler is adjusted to decrease the oil flow, be sure to readjust the oiler before returning to types of cutting that require greater lubrication.
- When the saw is run at high RPM's for long periods of time during certain types of cutting, such as pruning or debranching, more oil can be delivered than is required. To avoid running out of chain oil before running out of fuel, check the oil tank periodically.

4. IMPORTANT POINTS TO REMEMBER

- Fill the oil tank each time you refill the fuel tank to ensure there will be sufficient oil for the chain whenever you start and run the saw.
- Keep sawdust and debris cleaned from the oil holes in the guide bar to allow an adequate oil flow to the bar and chain.
- Keep spilled and spattered oil wiped from the unit to avoid sawdust and debris build-up. Pay particular attention to oil on the fan housing and starter assembly to avoid overheating the engine.
- It is normal for a small amount of oil to appear under the saw after the engine stops. This accumulation is oil drainage from the bar and chain when the unit is not in use.

ACCESSORIES

Available through your nearest Sears Store, Catalog Sales Office, or Service Center.

Catalog No.	Description
71-36565	File Guide
71-36527	File (11/64" Dia.) Twin Pack
71-36557	Depth Gauge Tool
71-3634	Replacement Chain for 2.8 - Low-Kickback - (33SL-72 drive links) (requires 11/64" dia. file)
71-3635	Replacement chain for 3.3 Low-Kickback -(78 drive links) (requires 11/64" dia. file)
71-36372	Replacement Guide Bar - 18" - Lo-Kick® Symmetrical
71-36373	Replacement Guide Bar - 20" - Low-Kick® - Symmetrical
71-36401	Spark Plug-Champion CJ-4
71-30143	2-Cycle Engine Oil
71-36554	Bar and Chain Lubricant (gallon size)*
71-36556	Bar and Chain Lubricant (quart size)*
71-33500	Fuel Stabilizer

*Available through your Sears Service Center/Catalogue.

USING YOUR SAW

A. CONTROL DEVICES

Understanding the control devices on your saw is an important part of learning how to properly and safely operate the unit. Figure 14.

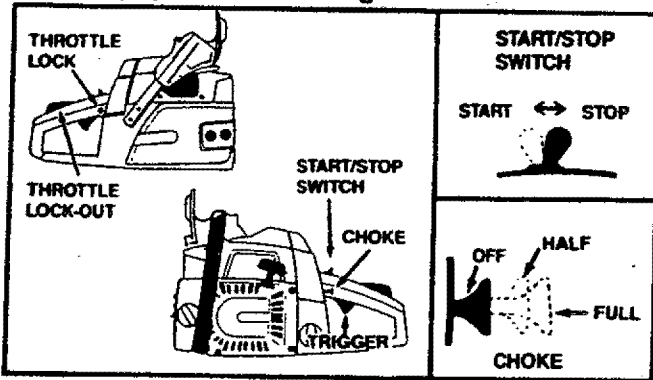

Figure 14

B. STARTING INSTRUCTIONS

⚠ WARNING

Always wear gloves; safety footwear; snug-fitting clothing; and eye, hearing, and head protection devices when operating a chain saw.

1. BASIC PROCEDURE

- Set the saw on flat ground making certain the saw chain is free to turn without contacting any object. Figure 15.
- Move start/stop switch to the "Start" position.
- Push down on the throttle lock-out, then squeeze the trigger. Press and hold down the throttle lock, then slowly release the trigger. Figure 14. When the trigger is released, the throttle lock is engaged.
- Adjust choke according to "Starting Procedure for Varying Conditions," step 2.
- Hold front handlebar with left hand. Place right foot through rear handle to stabilize saw.
- Pull starter rope quickly with your right hand.
- After engine has started, squeeze then release throttle trigger to release the throttle lock, allowing the engine to return to idle.

⚠ WARNING

The chain must not move when the engine runs at idle speed. Refer to "Carburetor Adjustment," Page 19, for correction.

- Stop engine by moving the ignition switch to the "STOP" position (Figure 14).

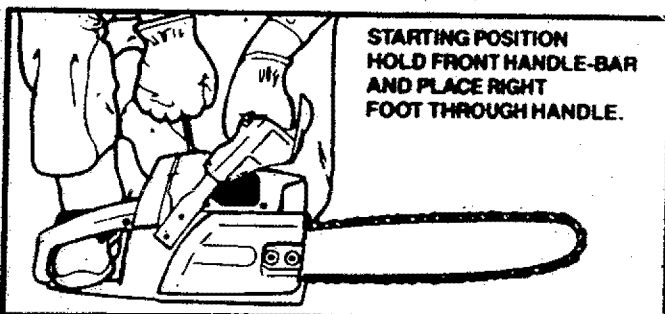

Figure 15

- The Start/Stop Switch is moved forward for the "Start" position and rearward for the "Stop" position.
- The two-position Choke helps to start the saw by controlling the air flow to the fuel system.
- The Trigger accelerates and controls the speed of the engine and is designed to be used with the throttle lock-out.
- The Throttle Lock-out prevents the trigger from becoming accidentally engaged. The throttle lock-out must be pressed before the trigger can be activated.
- The Throttle Lock holds the throttle lock-out and trigger in position while the engine is being started. Release the throttle lock after the engine is started by lightly squeezing the trigger.

2. STARTING PROCEDURE FOR VARYING CONDITIONS

NOTE: Be sure to follow "1. Basic Procedure," as described on this page.

a. COLD ENGINE

- Pull choke to full choke position. Figure 14.
- Pull starter rope until engine attempts to run.
- Push choke to the half position. Figure 14.
- Pull starter rope until engine runs.
- After 5 second warm up, push choke to the off position. Figure 14.

⚠ WARNING

Avoid bodily contact with the muffler when starting or using a warm engine to avoid serious burns.

b. WARM ENGINE

- Leave choke at the off position. Figure 14.
- Pull starter rope until engine runs.

c. REFUELED WARM ENGINE AFTER RUNNING OUT OF FUEL

- Pull choke to full choke position. Figure 14.
- Pull starter rope until engine attempts to run.
- Push choke to the off position. Figure 14.
- Pull starter rope until engine runs.

3. IMPORTANT POINTS TO REMEMBER

- When pulling the starter rope, do not use the full extent of the rope as this can cause the rope to break. Do not let the starter rope snap back. Hold the handle and let the rope rewind slowly.
- If engine floods, let the unit sit for a few minutes, then repeat starting procedure using the half-choke position.
- For cold weather starting, allow engine to warm up (1-2 min.) at the half-choke position, then move choke to the closed position. Do not cut with the choke at the "full" or "half" position.

TYPES OF CUTTING

A. BASIC CUTTING TECHNIQUE

1. IMPORTANT POINTS.

- Cut wood only. Do not cut metal, plastics, masonry, non-wood building materials, etc. Do not use your saw to pry or shove away limbs, roots, or other objects.
- Stop the saw if the chain strikes a foreign object. Inspect the unit and repair or replace parts as necessary.
- Keep the chain out of dirt and sand. Even a small amount of dirt will quickly dull a chain and increase the possibility of kickback.

▲ KICKBACK WARNING

Kickback can occur when the moving chain contacts an object at the upper portion of the tip of the guide bar or when the wood closes in and pinches the saw chain in the cut. Contact at the upper portion of the tip of the guide bar can cause the chain to dig into the object and stop the chain for an instant. The result is a lightning fast, reverse reaction which kicks the guide bar up and back toward the operator. If the saw chain is pinched along the top of the guide bar, the guide bar can be driven rapidly back toward the operator. Either of these reactions can cause loss of saw control which can result in serious injury.

2. UNDERSTAND REACTIVE FORCES

Pinch-Kickback and Pull-In occur when the chain is suddenly stopped by being pinched, caught, or by contacting a foreign object in the wood. This results in a reversal of the chain force used to cut wood and causes the saw to move in the opposite direction of chain rotation. Either reaction can result in loss of control and possible serious personal injury.

● Pinch-Kickback

- occurs when the chain on top of the bar is suddenly stopped when the top of the bar is used for cutting.
- rapidly drives the saw straight back toward the operator.

● Pull-In —

- can occur when the chain on the bottom of the bar is suddenly stopped.
- pulls the saw rapidly forward.

3. PROCEDURE

Practice cutting a few small logs using the following technique to get the "feel" of using your saw before you begin a major sawing operation.

- Accelerate the engine to full throttle just before entering the cut by squeezing the throttle trigger.
- Begin cutting the with spur against the log. Figure 16.
- Run the engine at full throttle the entire time you are cutting.
- Allow the chain to cut for you; exert only light downward pressure. If you force the cut, damage to the bar, chain, or engine can result.
- Release the throttle trigger as soon as the cut is completed, allowing the engine to idle. If you run the saw at full throttle without a cutting load, unnecessary wear can occur to the chain, bar, and engine.
- Do not put pressure on the saw at the end of the cut to avoid losing control when the cut is complete.
- Stop the engine before setting the saw down after cutting.

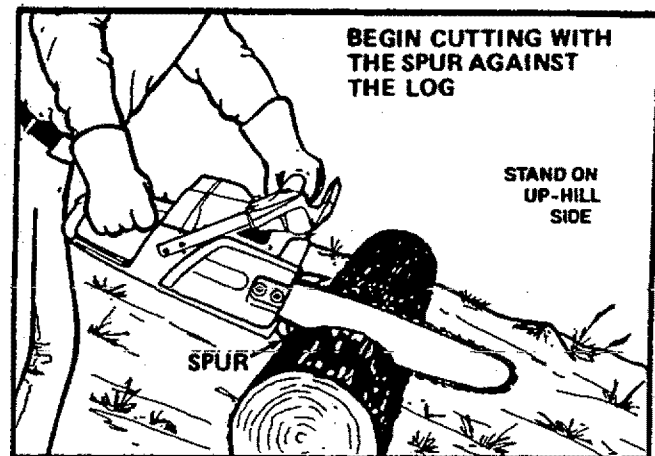

Figure 16

B. TREE FELLING TECHNIQUES

1. PLAN YOUR SAWING OPERATION CAREFULLY IN ADVANCE

- Clear the work area. You need a clear area all around the tree where you can have secure footing.
- Study the natural conditions that can cause the tree to fall in a particular direction:
 - The WIND direction and speed.
 - The LEAN of the tree.
 - WEIGHTED with BRANCHES on one side.
 - Surrounding TREES and OBSTACLES.
- Look for decay and rot. If the trunk is rotted, it could snap and fall toward the operator.
- Check for broken or dead branches which could fall on you while cutting.
- Make sure there is enough room for the tree to fall. Maintain a distance $2\frac{1}{2}$ tree lengths from the nearest person or other object. Engine noise can drown out a warning call.
- Remove dirt, stones, loose bark, nails, staples, and wire from the tree where cuts are to be made.
- Plan to stand on the up-hill side when cutting on a slope. Figure 16.
- Plan a clear retreat path to the rear and diagonal to the line of fall. Figure 17.

2. FELLING SMALL TREES — LESS THAN 6" IN DIAMETER

- a. If you know the direction of fall:
 - 1.) Make a single, horizontal felling cut on the side away from the direction of the fall.
 - 2.) Cut all the way through.
 - 3.) Stop the saw, put it down, and get away quickly on your planned retreat path.
- b. If you are not sure which way the tree will fall, use the notch method described for felling large trees.

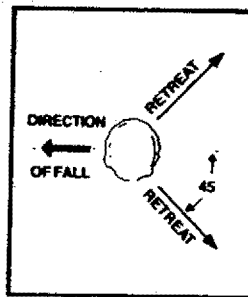

Figure 17

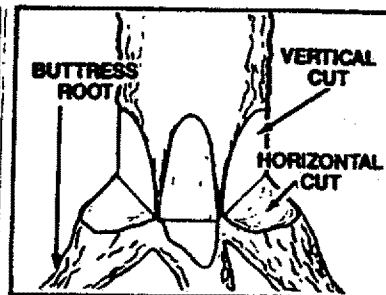

Figure 18

DO NOT CUT:

- near electrical wires or buildings.
- if you do not know the direction of tree fall.
- at night since you will not be able to see well.
- during bad weather — strong wind, snow, rain, etc.

⚠ WARNING

3. FELLING LARGE TREES — 6" DIAMETER OR MORE

The notch method is used to cut large trees. A notch is cut on the side of the tree in the desired direction of fall. After a felling cut is made on the opposite side of the tree, the tree will tend to fall into the notch.

NOTE: If the tree has large buttress roots, remove them before making the notch. Cut into the buttresses vertically, then horizontally. Figure 18.

- a. Make the notch cut. Figure 19.
 - Cut 1.) Cut the bottom of the notch first, through 1/3 of the diameter of the tree.
 - Cut 2.) Complete the notch by making the slant cut. Remove the notch of wood.
- b. Make the felling cut. Figure 20.
 - Cut 3.) Cut on the opposite side of the notch about 2" higher than the bottom of the notch.

- c. Leave enough uncut wood between the felling cut and the notch to form a hinge. Figure 20.

NOTE: The hinge helps to keep the tree from twisting and falling in the wrong direction.

- d. Insert a wedge in the felling cut if there is any chance that the tree will not fall in the desired direction.

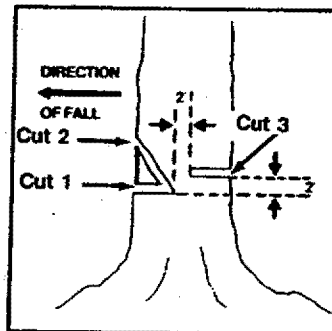

Figure 19

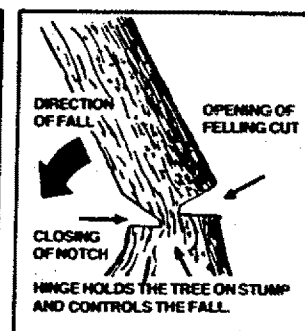

Figure 20

⚠ WARNING

Stay on the uphill side of the tree to avoid the tree rolling or sliding downhill into you. Figure 16.

NOTE: Before the felling cut is complete, drive wedges to open up the cut when necessary to control the direction of fall. Use wood or plastic wedges but *never* metal, to avoid kickback and chain damage.

- e. Be alert for signs that the tree is ready to fall:
 - 1.) cracking sounds
 - 2.) widening of the felling cut
 - 3.) movement in the upper branches.
- f. As the tree starts to fall, *remove and stop the saw, put it down, and get away quickly on your planned retreat path.*
- g. Be extremely cautious with partially fallen trees that may be poorly supported. When a tree doesn't fall completely, set the saw aside and pull down the tree with a cable winch, block and tackle, or tractor. To avoid injury, do not cut down a partially fallen tree with your saw.

DON'T PUT YOURSELF IN THESE POSITIONS

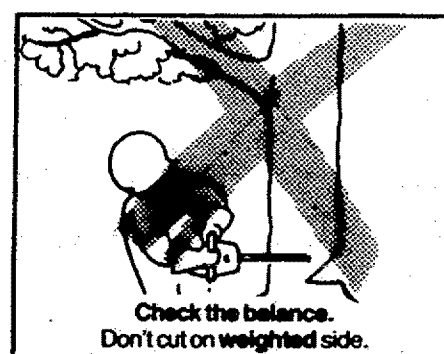
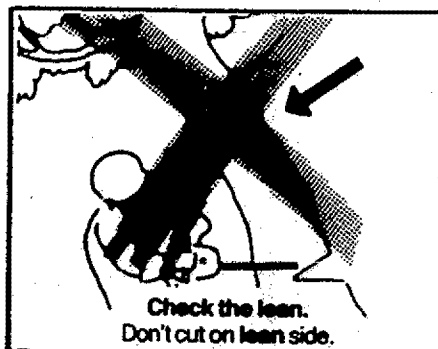
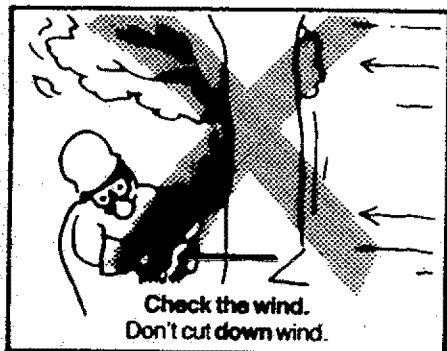

C. BUCKING

Bucking is the term used for cutting a fallen tree to the desired log size.

1. IMPORTANT POINTS

- Cut only one log at a time.
- Cut shattered wood very carefully. Sharp pieces of wood could be flung toward the operator.
- Use a sawhorse to cut small logs. Never allow another person to hold the log while cutting and never hold the log with your leg or foot.
- Give special attention to logs under strain to prevent the saw from pinching. Make the first cut on the pressure side to relieve the stress on the log. Figure 22.
- Do not cut in an area where logs, limbs, or roots are tangled such as in a blown down area. Pull out exposed and cleared logs first. Drag the logs into a clear area before cutting.
- Make the first bucking cut 1/3 of the way through the log and finish with a 2/3 cut on the opposite side. As the log is being cut, it will tend to bend. The saw can become pinched or hung in the log if you make the first cut deeper than 1/3 of the diameter of the log.

2. TYPES OF CUTTING USED Figure 22.

- **Overcutting** - begin on the top side of the log with spur against the log; exert light pressure downward.
- **Undercutting** - begin on the underside of the log with the spur against the log; exert light pressure upward. During undercutting, the saw will tend to push back at you. Be prepared for this reaction and hold the saw firmly to maintain control.

⚠ WARNING

Never turn the saw upside down to undercut. The saw cannot be controlled in this position.

⚠ WARNING

If saw becomes pinched or hung in a log, don't try to force it out. You can lose control of the saw resulting in injury and/or damage to the saw. Stop the saw; drive a wedge of plastic or wood into the cut until the saw can be removed easily. Figure 23. Restart the saw and carefully reenter the cut. To avoid kickback and chain damage, do not use a metal wedge. Do not attempt to restart your saw when it is pinched or hung in a log.

3. BUCKING—WITHOUT A SUPPORT

(Figure 23)

- Overcut with a 1/3 diameter cut.
- Roll log over and finish with an overcut.

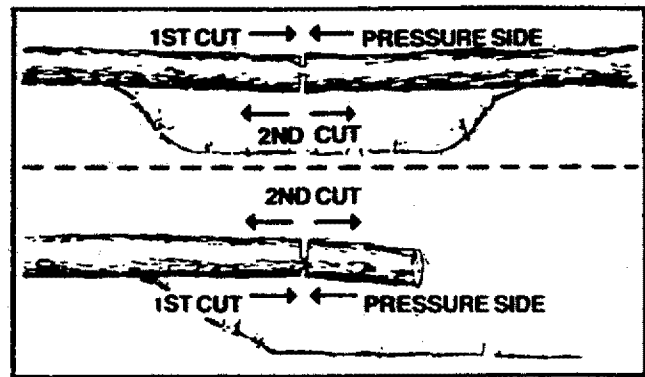

Figure 21

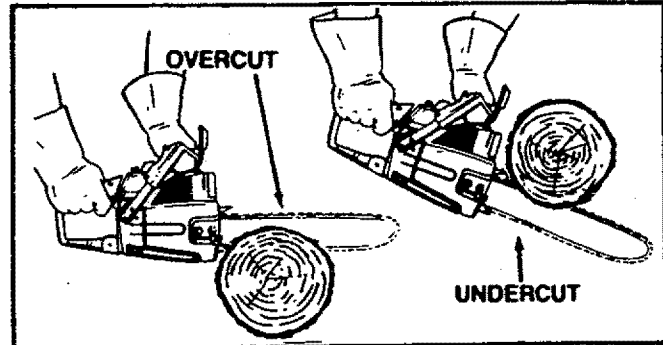

Figure 22

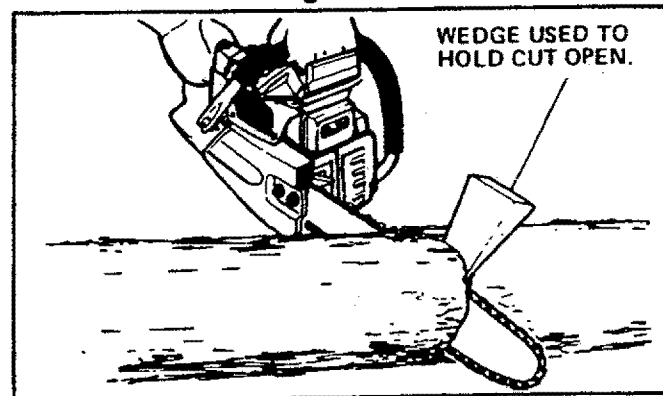

Figure 23

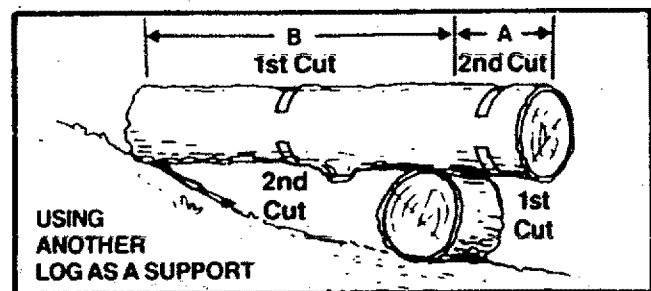

Figure 24

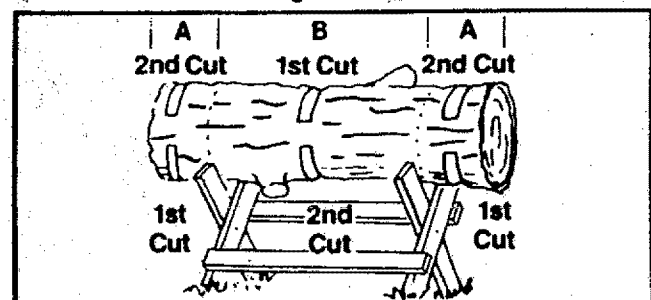

Figure 25

4. BUCKING — USING ANOTHER LOG AS A SUPPORT (Figure 24)

⚠ WARNING

Do not stand on the log being cut. Any portion can roll causing loss of footing and control.

- a. In area A:
 - 1.) Undercut 1/3 of the way through the log.
 - 2.) Finish with an overcut.
- b. In area B:
 - 1.) Overcut 1/3 of the way through the log.
 - 2.) Finish with an undercut.

5. BUCKING — USING A STAND (Figure 25)

- a. In area A:
 - 1.) Undercut 1/3 of the way through the log.
 - 2.) Finish with an overcut.

b. In area B:

- 1.) Overcut 1/3 of the way through the log.
- 2.) Finish with an undercut.

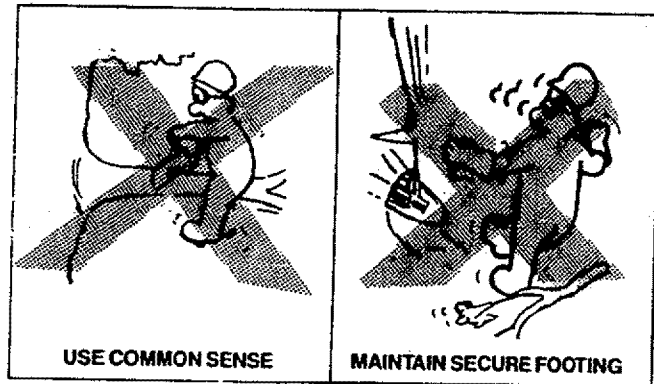

D. DEBRANCHING AND PRUNING

- Work slowly, keeping both hands firmly gripped on the saw. Maintain secure footing and balance.
- Watch out for springpoles. Use extreme caution when cutting small size limbs. Slender material can catch the saw chain and be whipped toward you or pull you off balance.
- Be alert for springback. Watch out for branches that are bent or under pressure as you are cutting to avoid being struck by the branch or the saw when the tension in the wood fibers is released.
- Keep a clear work area. Frequently, clear branches out of the way to avoid tripping over them.

⚠ WARNING

Never climb into a tree to debranch or prune. Do not stand on ladders, platforms, a log, or in any position which can cause you to lose your balance or control of the saw.

1. DEBRANCHING

- a. Always debranch a tree *after* it is cut down. Only then can debranching be done safely and properly.
- b. Leave the larger lower limbs to support the tree as you work.
- c. Start at the base of the felled tree and work toward the top, cutting branches and limbs. Remove small limbs with one cut. Figure 26.
- d. Keep the tree between you and the chain. Cut from the side of the tree opposite the branch you are cutting.
- e. Remove larger, supporting branches with the 1/3, 2/3 cutting techniques described in the bucking section.
- f. Always use an overcut to cut small and freely hanging limbs. Undercutting can cause limbs to fall and pinch the saw.

2. PRUNING

- a. Limit pruning to limbs shoulder height or below. Do not cut if branches are higher than your shoulder. Get a professional to do the job.
- b. Refer to Figure 27 for the pruning technique.
 - 1.) Undercut 1/3 of the way through the limb near the trunk of the tree.
 - 2.) Finish with an overcut farther out from the trunk.
 - 3.) Keep out of the way of the falling limb.
 - 4.) Cut the stump flush near the trunk of the tree.

⚠ WARNING

Be alert for and guard against kickback. Do not allow the moving chain to contact any other branches or objects at the nose of the guide bar when debranching or pruning. Allowing such contact can result in serious injury.

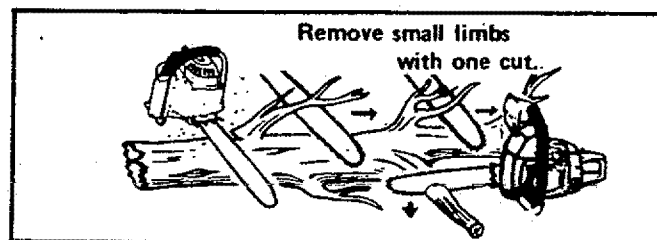

Figure 26

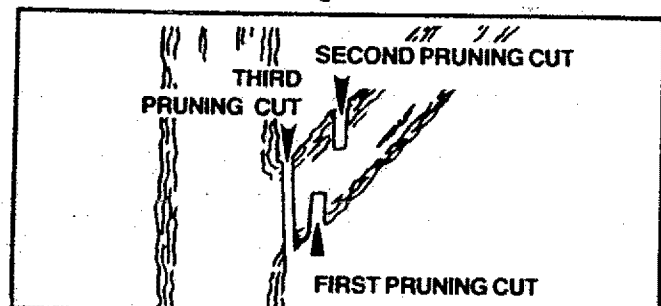

Figure 27

MAINTENANCE

A good maintenance program of regular inspection and care will increase the service life and help to maintain the safety and performance of your saw.

- Make all adjustments or repairs (except carburetor adjustments) with:
 - spark plug wire disconnected.
 - engine cool as opposed to a unit that has just been run.

- Check the saw for loose bolts, screws, nuts, and fittings regularly. Loose fasteners can cause an unsafe condition as well as damage to your saw. Tools required are described on page 7.

⚠ WARNING

Have all chain saw service performed by your Sears Service Center with the exception of the items listed in the maintenance section of this manual

A. GUIDE BAR AND CHAIN

Increase the service life of your Guide Bar and Chain by:

- Using the saw properly and as recommended in this manual.
- Maintaining correct Chain Tension, page 9.
- Proper lubrication, page 10.
- Regular maintenance as described in this section.

1. CHAIN MAINTENANCE

- Sharpen the chain when:
 - wood chips are small and powdery. Wood chips made by the saw chain should be about the size of the teeth of the chain.
 - saw has to be forced through the cut.
 - saw cuts to one side.

CAUTION: Always wear gloves when handling the chain. The chain is sharp enough to cut you even though it is too dull to cut wood.

a. SHARPENING INSTRUCTIONS

Items required:

Gloves	Medium Flat File
11/64" dia. File	Depth Gauge Tool
6" File Holder	Vise

- 1.) Stop engine and disconnect spark plug.
- 2.) Adjust the chain for proper tension, page 8.
- 3.) Work at the midpoint of the bar, moving the chain forward by hand as each cutter is filed.
- 4.) Sharpen cutters.
 - a.) Position file holder (with 11/64" round file) on cutter top plate and depth gauge. Figure 28.
 - b.) Hold the file holder level with the 30° guide mark parallel to the center of the chain. Figure 29.
 - c.) File from inside toward outside of cutter, straight across, on forward stroke only. Use 2 or 3 strokes per cutting edge. Figure 29.
 - d.) Keep all cutters the same length. Figure 30.
 - e.) File enough to remove any damage to cutting edge (side & top plate) of cutter. Figure 30.
 - f.) File chain to meet specifications shown in Figure 31.

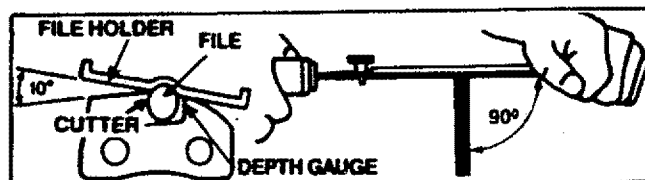

Figure 28

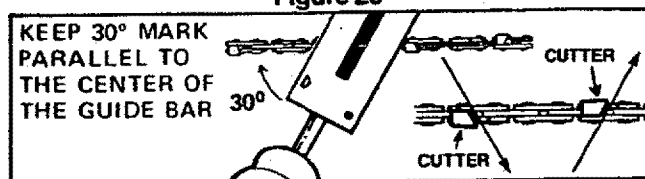

Figure 29

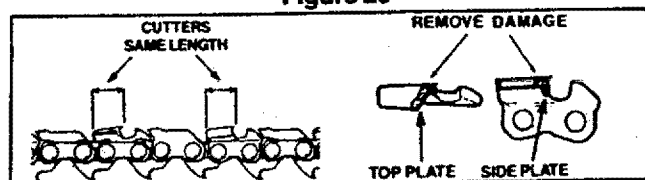

Figure 30

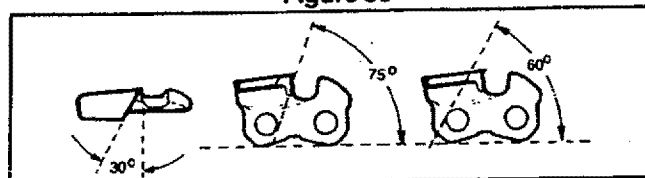

Figure 31

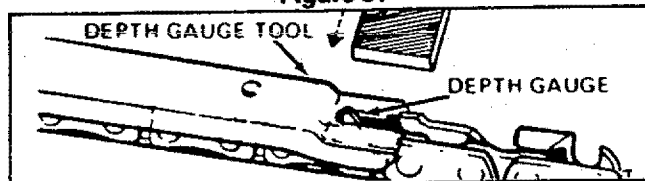

Figure 32

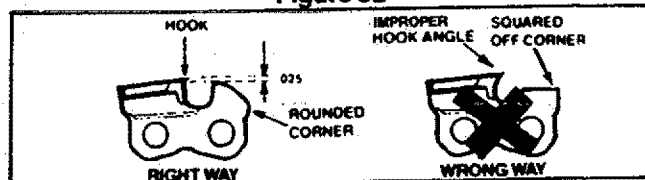

Figure 33

⚠ WARNING

Maintain the proper hook angle according to the manufacturer's specification for the chain you are using. Improper hook angle will increase the chance of kickback which can result in serious injury. Figures 31 & 33.

5.) Correct Depth Gauges

- Place depth gauge tool over each cutter depth gauge. Figure 32.
- File level with the flat file if depth gauge is higher than the depth gauge tool.
- Maintain rounded front corner of depth gauge with a flat file. Figures 32 & 33.

NOTE: The very top of the depth gauge should be flat with the front half rounded off with a flat file.

▲ WARNING

Depth gauge tool is required to insure proper depth gauge. Filing the depth gauge too deep will increase the chance of kickback which can result in serious injury.

b. CHAIN REPLACEMENT

- Use only the Low-Kick Chain specified for your saw in "Specifications" for replacement chain.
- Replace the chain when cutters or links break.
- See your Sears Service Center to replace and sharpen individual cutters for matching your chain.
- Always have a worn sprocket replaced by your Sears Service Center when installing a new chain to avoid excessive wear to the chain.

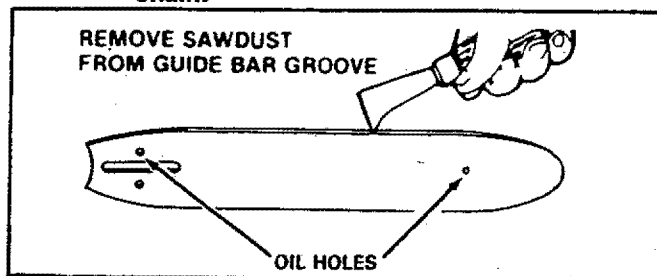

Figure 34

2. GUIDE BAR MAINTENANCE

- Conditions which can require guide bar maintenance:
 - saw cuts to one side
 - saw has to be forced through a cut
 - inadequate supply of oil to bar and chain.
- Check the condition of the guide bar each time the chain is sharpened. A worn guide bar will damage the chain and make cutting more difficult. Reverse bar after every cleaning.
- Replace the guide bar when:
 - the inside groove of the guide bar rails is worn.
 - the guide bar is bent or cracked.
- Use only the replacement Reduced-Kickback Guide Bar specified for your saw in "Specifications."
 - Remove the guide bar to service.
 - Clean oil holes at least once for each five hours of operation. Figure 34.
 - Remove sawdust from the guide bar groove periodically with a putty knife or a wire. Figure 34.
 - Remove burrs by filing the side edges of the guide bar grooves square with a flat file. Figure 35.
 - Restore square edges to an uneven rail top by filing with a flat file. Figure 35.

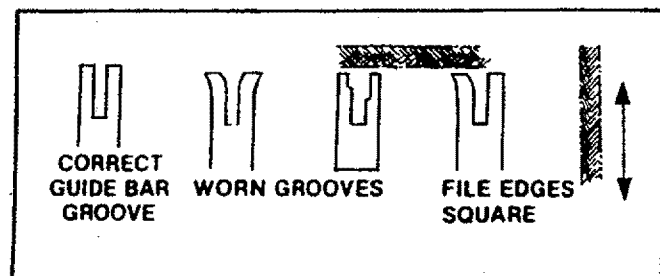

Figure 35

B. SPARK ARRESTOR AND SPARK PLUG

1. SPARK ARRESTOR

- Carbon deposits build up on the spark arrestor as the saw is used and must be removed to avoid creating a fire hazard or causing engine damage.
- Replace the spark arrestor if breaks occur.
- Keep the spark arrestor clean at all times.
Clean:
 - as required
 - at least once for each 25-30 hours of operation

Items required:
wire brush, 3/8" wrench

- Disconnect the spark plug wire.
- Remove the heat shield. Figure 36.
- Remove the screen from the diffuser.
- Clean the screen with a wire brush or replace if breaks are found.
- Reassemble parts.

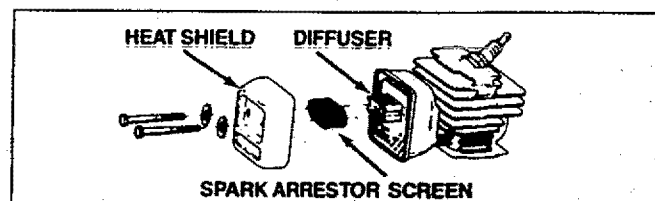

Figure 36

2. SPARK PLUG

- Replace the spark plug when necessary. Use Stock No. 71-36401.
- If you perform this maintenance yourself, note the "Caution" below.

CAUTION: Do not mix chrome-colored fan housing screws with the black-colored cylinder shroud screws. Other than color, these screws are similar in appearance; but if interchanged, they can strip out and/or cause permanent engine damage.

C. STARTER ROPE

- Replace the starter rope if the rope breaks or is badly worn.



⚠ WARNING

Always wear eye protection when servicing the starter rope. The recoil spring beneath the pulley is under tension. If the spring pops out, serious injury can result.

NOTE: The recoil spring, located beneath the pulley, is under tension. If the spring pops out, it will require considerable time and effort to reinstall. For this reason you may want to let your Sears Service Center/Department handle this repair. If you try to repair the starter rope and the recoil spring pops out, take the unit to your Sears Service Center/Department.

1. Remove the four screws on the side of the fan housing. Figure 37.

CAUTION: Do not mix chrome-colored fan housing screws with the black-colored cylinder shroud screws. Other than color, these screws are similar in appearance; but if interchanged, they can strip out and/or cause permanent engine damage.

2. Remove the fan housing.
3. If the starter rope is broken, proceed to step "4." If the starter rope is not broken, release the tension on the spring as follows:
 - a. Pull about 12 inches of rope from the pulley and catch the rope in the notch as shown in Figure 38.
 - b. Turn the pulley counterclockwise until the spring tension is released.
4. Unthread the pulley screw in the center of the pulley with a 5/32" allen wrench until the pulley assembly can be removed from the fan housing. Figure 39.
5. Lift the pulley *carefully* while gently twisting the pulley counterclockwise. Remove the old rope.

6. Move away from the fuel tank and melt the end of the new rope.
7. Allow the melted end to drip once; then while the rope is still hot, pull the melted end through a rag to obtain a smooth, pointed end.
8. Feed the rope through the round starter hole in the fan housing. Figure 39.
9. Guide rope inside pulley, then through topside pulley hole by pushing the rope from the underside hole with a small round object, such as a Phillips screwdriver. See inset. Figure 39.
10. Tie a knot in the end of the rope leaving no more than a 3/8 to 1/4 inch tail and pull the knot snugly into the corner of the groove in the pulley. Figure 38.
11. Tuck the tail on the rope knot into the inner curved section to avoid interference with the flywheel. Figure 38 & 40.
12. Set the pulley assembly in the housing; push it down and engage the spring.
13. Tighten the pulley screw. Do not overtighten screw.

NOTE: If you remove the pulley screw from the pulley, make sure the starter dog, retainer, cam, and wave washer are positioned and installed properly as shown in Figure 39. If parts have been cleaned, apply a small amount of grease to both sides of the cam and wave washers.
14. Make sure the cam is installed on the starter dog in the direction shown in Figure 39. Also make sure the wave washer is seated around the top outer edge of the retainer and not caught between the top of the retainer and the pulley screw.
15. Catch the rope in the notch in the pulley. Figure 40.
16. Turn the pulley clockwise to wind up the spring until it will turn no more without forcing. *Hold the pulley by hand. Do not let go of the pulley.* Let the pulley unwind one full turn and release the rope from the slot. Continue to hold pulley.
17. Hold the pulley and pull the starter rope to the full extent. Release the pulley and let the rope rewind slowly.
18. Reinstall fan housing and the four chrome-colored screws. Tighten screws securely.

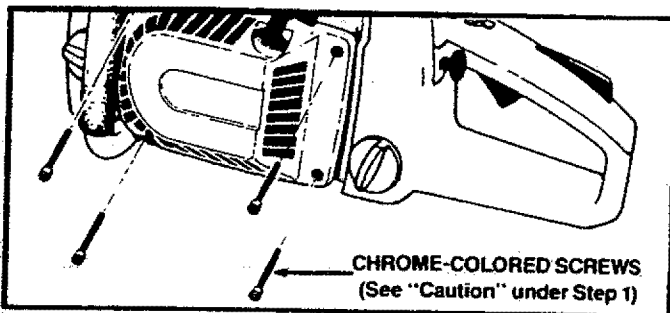

Figure 37

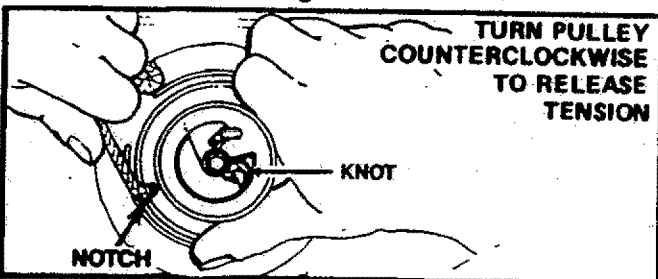

Figure 38

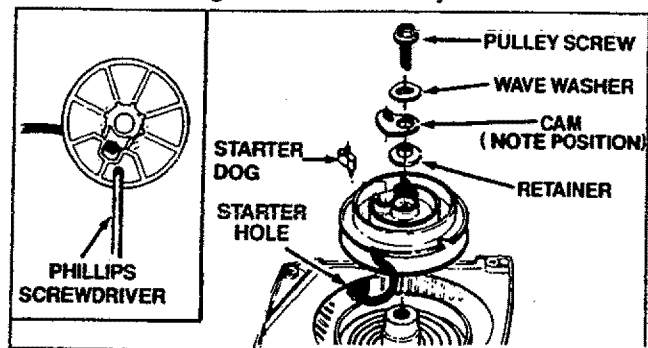

Figure 39

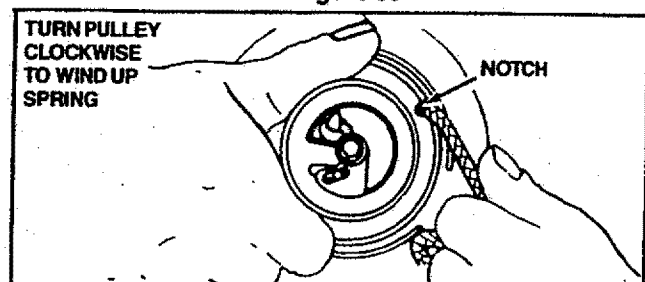

Figure 40

D. CARBURETOR ADJUSTMENTS

- Poor engine performance can be a result of other causes such as dirty air filter, carbon build-up on muffler outlets, etc. See "Trouble Shooting Chart" before proceeding with carburetor adjustments.
- The carburetor has been adjusted at the factory for sea level conditions. Adjustments may become necessary if the unit is used at significantly higher altitudes or if you notice any of the following conditions:

NOTE: Be sure to properly prepare the saw as described in "1. Preparation" below, before making any adjustments.

- Chain moves when the engine runs at idle speed. See "2. Idle Speed Adjustment."
- Saw will not idle. See "2. Idle Speed Adjustment" and "3. Low Speed Mixture Adjustment."
- Loss of cutting power which is not corrected by air filter cleaning. "See "5. High Speed Mixture Adjustment."
- Engine dies or hesitates when it should accelerate. See "4. Acceleration Adjustment."

CAUTION: Permanent damage will occur to any 2-cycle engine if incorrect carburetor adjustments are made.

- If the unit will not operate properly after making these adjustments, take the unit to your Sears Service Center.

⚠ WARNING

The chain will be moving during most of this procedure. Wear your protective gear and observe all safety precautions.

1. PREPARATION

- Stop engine.
- Use a fresh fuel mixture with proper gasoline/oil ratio.
- Place the saw on a solid, flat surface and make sure the chain will not contact any object.
- Locate the three (3) carburetor adjusting screws to the right of the air filter cover. Figure 41.
- Start the engine and allow engine to idle 3 minutes to warm up. *The engine must be at operating temperature for proper adjustments to be made.*

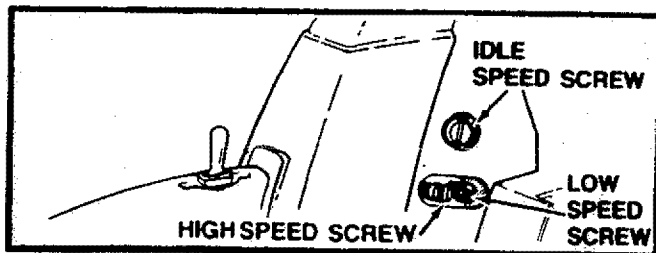

Figure 41

2. IDLE SPEED ADJUSTMENT

- Allow engine to idle.
- Adjust **Idle Speed Screw** until engine continues to run without stalling and without the chain moving.
 - Turn screw clockwise to increase engine speed if engine stalls or dies.
 - Turn screw counterclockwise to slow engine down and/or to keep the chain from turning.
- No further adjustments are necessary if the chain does not move at idle speed and if performance is satisfactory.

⚠ WARNING

Recheck idle speed after each adjustment below. The chain must not move at idle speed to avoid serious injury.

3. LOW SPEED MIXTURE ADJUSTMENT

- Allow engine to idle.
- Turn the **Low Speed Mixture Screw** slowly clockwise until the RPM starts to drop. Note the position.
- Turn the **Low Speed Mixture Screw** counterclockwise until the RPM speeds up and starts to drop again. Note the position.
- Set the **Low Speed Mixture Screw** at the midpoint between the two positions.

4. ACCELERATION ADJUSTMENT

If engine dies or hesitates instead of accelerating, turn the **Low Speed Mixture Screw** 1/16 of a turn at a time counterclockwise until you have smooth acceleration.

5. HIGH SPEED MIXTURE ADJUSTMENT

CAUTION: Adjustments as small as 1/16 of a turn can affect engine performance. It is important to turn the screw only 1/16 of a turn per adjustment and test the performance of the saw before making further adjustments.

- Make a test cut.
- Adjust the **High Speed Mixture Screw** 1/16 of a turn as follows:
 - Clockwise if saw smokes or loses power.
 - Counterclockwise if the saw has speed out of the cut but lacks power in the cut.
- Repeat test cut.
- Continue 1/16 of a turn adjustments until the saw runs smoothly in cut.

CAUTION: A too lean high speed setting (clockwise adjustment) will cause engine damage to any 2-cycle engine from overheating and lack of lubrication. Never set the high speed mixture screw so far clockwise that you have high engine speed but lack power while cutting. An effective approach follows:

- Turn screw counterclockwise until engine loses power while cutting.
- Then, turn screw clockwise in 1/16 of a turn increments *only until* the engine has power while cutting.

NOTE: If the unit will not operate properly after making these adjustments, take the unit to your Sears Service Center/Department.

E. CLUTCH AND DRUM/SPROCKET

⚠ WARNING

Do not start engine without Guide Bar, Chain, and Bar Clamp Housing completely assembled. The clutch can come off without the guide bar and chain completely assembled and serious injury can result. The clutch shoes and drum can separate causing the clutch to violently fly apart and serious injury can result.

- Take the saw to your Sears Service Center for full clutch inspection and service after each 100 hours of operation. It is recommended that you do not try to service the clutch or drum/sprocket yourself unless you are a competent small engine mechanic and have the proper clutch service tools. Proper disassembly and repair of the clutch is extremely important to the life of the engine and the safety of the operator.
- Clutch maintenance is required when:
 - the chain continues to turn while engine idles after the idle speed screw has been adjusted to its capacity.
 - slippage occurs during a cut.
 - a chattering noise occurs during cutting.
- Clean the clutch, drum, sprocket, and surrounding area daily during heavy use of the saw. Check to see that the clutch drum turns freely and smoothly.
- Inspect the sprocket regularly for wear. A worn sprocket will make the chain run erratically and will shorten the life of the bar and chain. Figure 42.
- Always have a worn sprocket replaced by your Sears Service Center/Department whenever a new chain is installed to gain the full life expectancy of the chain.

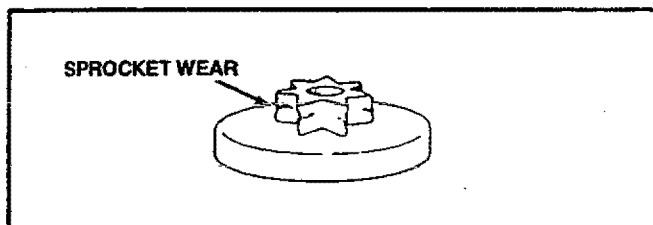

Figure 42

F. AIR FILTER

- A dirty air filter:
 - reduces cutting power.
 - increases fuel consumption
- Clean the air filter:
 - frequently, especially in very dusty conditions.
 - always after 10 tanks of fuel mixture or 5 hours of operation, whichever is less.
- Replace the air filter if it is damaged.

CAUTION: Never operate the unit without the air filter in place to avoid damage to the engine.

Items Required: soft bristled brush, such as a paint brush.

1. Clean off the carburetor cover and the area around it.
2. Pull choke to the full position (Figure 14) to prevent dirt from entering the carburetor.
3. Remove the carburetor cover.
4. Remove the air filter carefully. Figure 43.
5. Remove single top screw and separate the two halves.

CAUTION: Do not use gasoline or other flammable liquid to clean the filter to avoid creating a fire hazard.

6. Soak filter in soap and water.
7. Brush away all dust and debris from the filter.
8. Allow filter to dry.
9. Reassemble filter.
10. Brush away all debris from surfaces on which the filter is to be placed.
11. Replace the filter and carburetor cover.

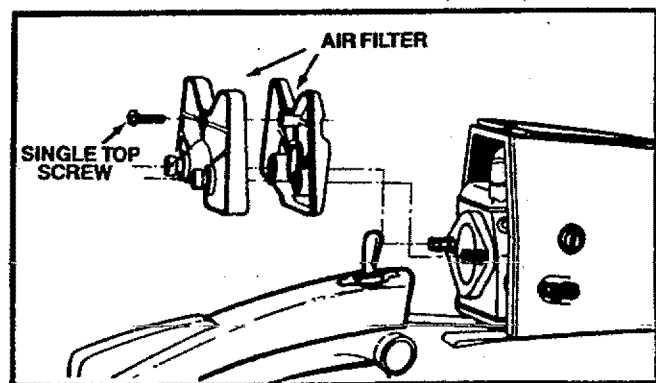

Figure 43

G. STORAGE

When your saw is to be stored for over 30 days, always:

1. Run the fuel out of the fuel tank, carburetor, and fuel lines by starting the engine and allowing it to run at idle speed until it stops. (See "Fueling Your Engine.")
NOTE: It is important to prevent gum deposits from forming in essential fuel systems parts such as the carburetor, fuel filter, fuel hose, or tank during storage. Alcohol blended fuels (called gasohol or using ethanol or methanol) can attract moisture which leads to separation and formation of acids during storage. Acidic gas can damage the fuel system of an engine while in storage.
NOTE: If you do not want to remove the gasoline from your unit, SEARS CRAFTSMAN Fuel Stabilizer (#71-33500) may be added to gasoline

left in the tank to minimize gum deposits and acids. If the tank is almost empty, mix stabilizer with fresh gasoline in a separate container and add to the tank.

CAUTION: Wear protective gloves when handling the chain. The chain is sharp and can cut you even when it is not moving.

2. Drain oil tank.
3. Remove, clean, and dry the bar and chain.
4. To protect the chain from rust, store it in a container filled with oil.
5. Apply a coating of oil to the entire surface of the bar and wrap it in heavy paper, cloth, or plastic.
6. Clean the outside surfaces of the engine.
7. Store the saw in a dry place, out of the reach of children, and away from where fuel vapors can reach open flames from hot water heaters, furnaces, etc.

H. TROUBLE SHOOTING CHART

TROUBLE	CAUSE	REMEDY
ENGINE WILL NOT START	<ol style="list-style-type: none"> 1. Ignition Switch off. 2. Fuel tank empty. 3. Spark Plug not firing. 4. Engine flooded. 5. Fuel not reaching carburetor. 6. Compression low. 	<ol style="list-style-type: none"> 1. Move switch to "Start." 2. Fill tank with correct fuel mixture. 3. Install new plug/check ignition system. 4. See Starting Instructions. 5. Check for dirty fuel filter; clean. Check for kinked or split fuel line; repair or replace. 6. Contact your Sears Service Center.
ENGINE WILL NOT IDLE PROPERLY	<ol style="list-style-type: none"> 1. Idle speed set too low. 2. Idle speed set too high. 3. Low speed screw requires adjustment. 4. Crankshaft seals worn. 5. Compression low. 	<ol style="list-style-type: none"> 1. Adjust idle speed screw clockwise to increase speed. 2. Adjust idle speed screw counterclockwise to reduce speed. 3. See Carburetor Adjustments. 4. Contact your Sears Service Center. 5. Contact your Sears Service Center.
ENGINE WILL NOT ACCELERATE, LACKS POWER, OR DIES IN THE CUT	<ol style="list-style-type: none"> 1. Air filter is dirty. 2. Spark plug fouled. 3. Carbon build-up on exhaust ports on muffler outlets. 4. Carburetor requires adjustment. 5. Low Compression. 	<ol style="list-style-type: none"> 1. Clean or replace air filter. 2. Clean or replace Spark Plug and regap. 3. Contact your Sears Service Center. 4. See Carburetor Adjustments. 5. Contact your Sears Service Center.
ENGINE SMOKES EXCESSIVELY	<ol style="list-style-type: none"> 1. Choke partially on. 2. Air filter dirty. 3. Oil rich fuel mixture. 4. High speed needle requires adjustment. 5. Crankcase leak. 	<ol style="list-style-type: none"> 1. Push Choke in. 2. Clean or replace air filter. 3. Empty fuel tank and refill with correct fuel mixture. 4. See Carburetor Adjustments. 5. Contact your Sears Service Center.
ENGINE RUNS HOT	<ol style="list-style-type: none"> 1. Fan Housing dirty. 2. Fuel Mixture incorrect. 3. Spark Plug incorrect. 4. High Speed Mixture set too low. 5. Carbon build-up on spark arrestor screen. 6. Carbon build-up on exhaust ports or muffler outlets. 	<ol style="list-style-type: none"> 1. Clean fan housing. 2. See Engine Fuel Mixture. 3. Replace with correct plug. 4. See Carburetor Adjustments. 5. Clean spark arrestor screen. 6. Contact your Sears Service Center.
OIL INADEQUATE FOR BAR AND CHAIN LUBRICATION	<ol style="list-style-type: none"> 1. Oil tank empty. 2. Improperly adjusted oiler (if so equipped). 3. Oil pump or oil filter clogged. 4. Guide bar oil hole blocked. 	<ol style="list-style-type: none"> 1. Fill oil tank. 2. Adjust oiler. 3. Contact your Sears Service Center. 4. Remove bar and clean.
CHAIN MOVES AT IDLE SPEED	<ol style="list-style-type: none"> 1. Idle speed requires adjustment. 2. Clutch requires repair. 	<ol style="list-style-type: none"> 1. See Carburetor Adjustments. 2. Contact your Sears Service Center.
CHAIN DOES NOT MOVE WHEN ENGINE IS ACCELERATED	<ol style="list-style-type: none"> 1. Chain tension too tight. 2. Carburetor requires adjustment. 3. Guide bar rails pinched. 4. Clutch slipping. 	<ol style="list-style-type: none"> 1. See Chain Tension. 2. See Carburetor Adjustments. 3. Repair or replace. 4. Contact your Sears Service Center.
CHAIN CLATTERS OR CUTS ROUGHLY	<ol style="list-style-type: none"> 1. Chain tension incorrect. 2. Cutters damaged after striking foreign material. 3. Chain wear due to contact with dirt, sand, or frozen wood. 4. Cutters dull, improperly sharpened; depth gauges too high. 5. Sprocket worn. 	<ol style="list-style-type: none"> 1. See Chain Tension. 2. Contact your Sears Service Center. 3. Resharpener or replace chain. 4. See Chain Sharpening Instructions. 5. Contact your Sears Service Center.
CHAIN STOPS WITHIN THE CUT	<ol style="list-style-type: none"> 1. Chain cutter tops not filed flat. 2. Guide bar burred or bent; rails uneven. 3. Clutch slipping. 	<ol style="list-style-type: none"> 1. See Chain Sharpening Instructions. 2. Repair or replace Guide Bar. 3. Contact your Sears Service Center.
CHAIN CUTS AT AN ANGLE	<ol style="list-style-type: none"> 1. Cutters damaged on one side. 2. Chain dull on one side. 3. Guide bar bent or worn. 	<ol style="list-style-type: none"> 1. Resharpener until all cutters have equal angles and lengths. 2. Resharpener until all cutters have equal angles and lengths. 3. Replace guide bar.

I. MAINTENANCE CHART

		before starting work	After each refueling stop after finishing work or daily	weekly	monthly
Complete machine	Visual inspection (condition, leaks)	x		x	
	Clean		x		
Throttle trigger, safety throttle lock, stop switch	Check operation	x		x	
Filter in fuel tank	Replace — when clogged or dirty				
Chain lubrication	Fill	x		x	
Saw Chain	Inspect (sharpness, wear, damage)	x		x	
	Check chain tension	x		x	
	Sharpen — when dull				
Guide bar	Inspect (wear, damage)	x			
	Clean groove				x
	Deburr — when needed				
	Replace — when worn or damaged				
Chain sprocket	Check			x	
Air Filter	Clean	x			
	Replace — when worn or damaged				
Cylinder fins	Clean				x
Carburetor	Check idle adjustment — chain must not turn	x			
Spark plug	Replace — when fouled or damaged				
All accessible screws and nuts (not adjusting screws)	Retighten	x			
Vibration mounts	Inspect (tears, rips, separation, out-of-round)				x
	Replace — when worn or damaged				
Spark arrestor screen	Inspect				x
	Replace — when worn or damaged				

NOTE: When cutting fibrous material such as palms, pampas grass, yucca, etc., clean the cooling system (including cylinder cooling fins) after every other refueling.

SEARS CHAIN SAW REPAIR PARTS LIST MODEL 358.356281-2.8/18" MODEL 358.356332-3.3/20"

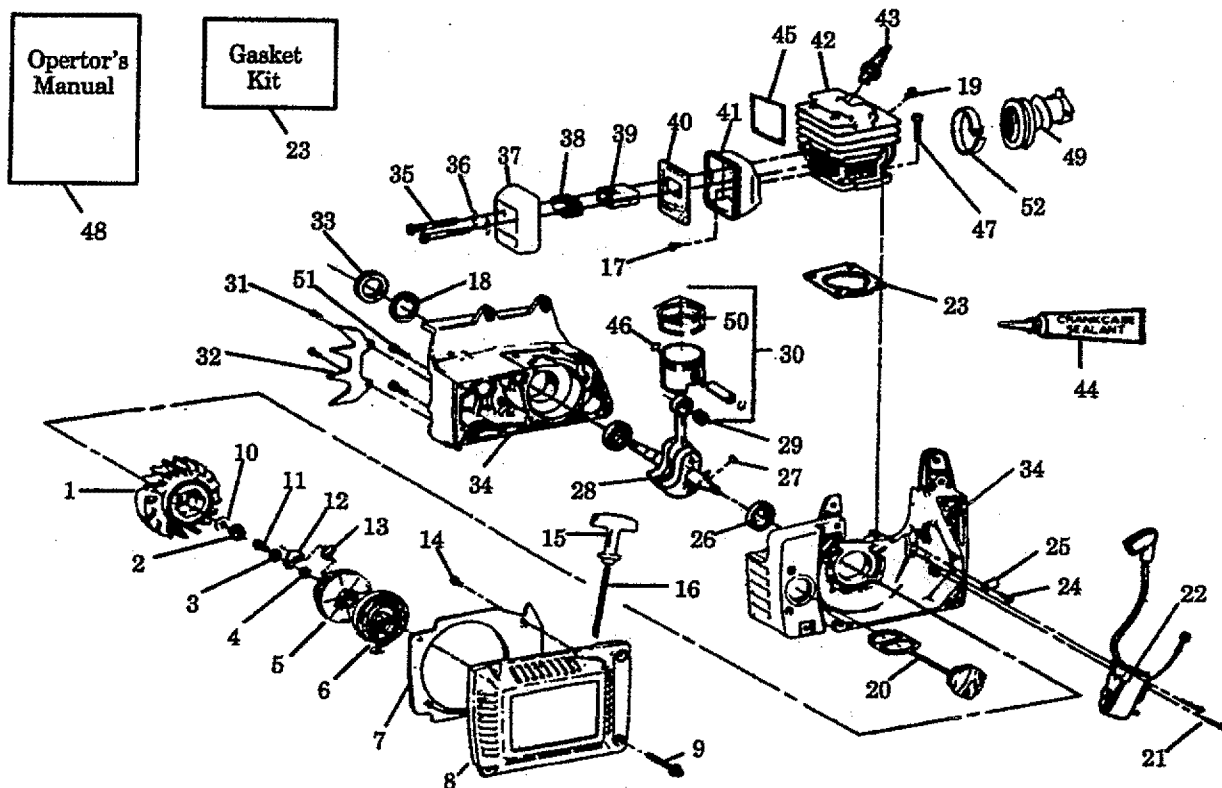

KEY NO.	PART NO.	DESCRIPTION	KEY NO.	PART NO.	DESCRIPTION
1	530-039127	Flywheel	31	530-015710	Screw
2	STD541137	Nut	32	530-027184	Spur
3	530-015254	Wave Washer	33	530-019146	Crankshaft Seal
4	530-027163	Retainer	34	530-014719	Crankcase Ass'y. (Incl. #'s 18, 26, 33, 125, 126, 127, 137, 138, 141 & 142)
5	530-027170	Starter Pulley	35	530-015718	Screw
6	530-042067	Starter Spring	36	530-015722	Washer
7	530-027096	Baffle Plate	37	530-028645	Muffler Cover
8	-	Fan Housing	38	530-027095	Spark Arrestor Screen
	530-010861	Model 358.356281	39	530-028647	Muffler Diffuser
	530-014272	Model 358.356332	40	530-028646	Muffler Baffle Plate
9	530-015709	Screw	41	530-028644	Muffler Body
10	530-015441	Washer	42	-	Cylinder
11	530-015713	Screw		530-012155	Model 358.356281
12	530-027765	Starter Cam		530-012200	Model 358.356332
13	530-027162	Starter Dog	43	530-030034	Spark Plug (CJ-4)
14	STD610603	Screw	44	530-030054	Sealant
15	530-026735	Starter Handle	45	530-027838	Deflector
16	530-069233	Rope Kit			Model 358.356332 Only
17	530-015720	Bolt	46	530-015697	Retainer
18	530-001516	Snap Ring	47	530-001624	Screw
19	530-015696	Clip	48	530-081372	Operator's Manual
20	530-010846	Oil Cap Ass'y. (Incl. "O" Ring)	49	530-027218	Carb. Adaptor
21	530-015708	Screw	50	-	Piston Ring
22	530-039128	Ignition Module (Incl. High Tension Lead Ass'y.)		530-027090	Model 358.356281
		Gasket Set (Includes 79 & 108)		530-027607	Model 358.356332
23	530-069550	Gasket Set (Includes 79 & 108)	51	530-015707	Screw
24	530-015306	Screw	52	530-027285	Clamp Ass'y.
25	530-027264	Clamp			Not Shown
26	530-032093	Crankshaft Bearing			530-061329
27	STD580008	Flywheel Key			Model 358.356281
28	530-027143	Crankshaft/Rod Ass'y.			530-061349
29	530-032111	Piston Pin Bearing			Model 358.356332
30	-	Piston Kit (Includes: 29, 46, 50 & Piston Pin)			Carton
	530-010864	Model 358.356281			Model 358.356281
	530-010986	Model 358.356332			Model 358.356332

SEARS CHAIN SAW REPAIR PARTS LIST MODEL 358.356281-2.8/18" MODEL 358.356332-3.3/20"

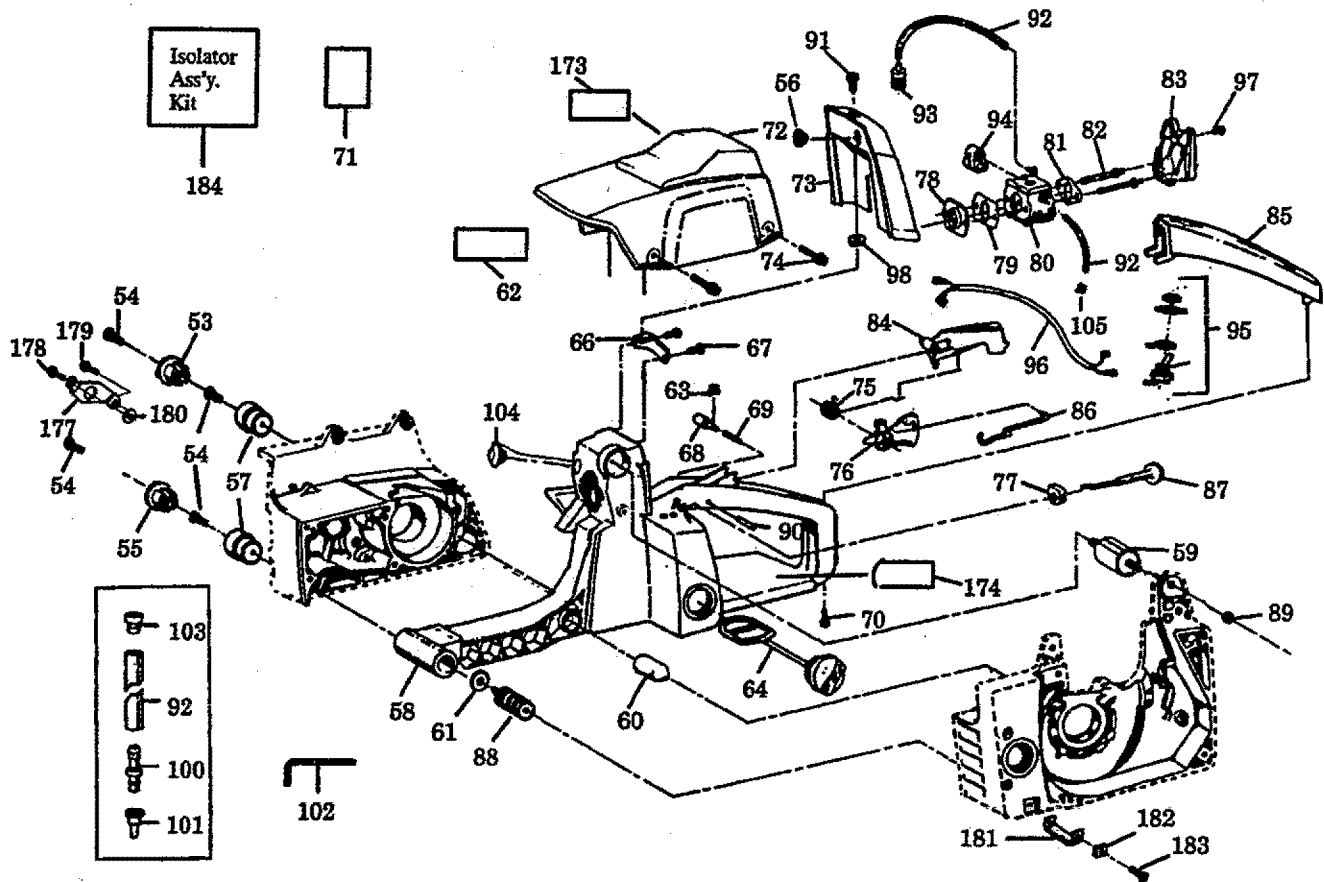

KEY NO.	PART NO.	DESCRIPTION	KEY NO.	PART NO.	DESCRIPTION
53	530-027732	Retainer Mount	85	530-027207	Rear Handle Cover
54	530-016057	Screw	86	530-027073	Throttle Wire
55	530-027183	Chain Catcher Retainer	87	530-027075	Choke Knob
56	530-027399	Bumper-Carb. Cover	88	530-036962	Spring Ass'y.
57	530-027392	Lower Isolator	89	530-001543	Nut
58	530-069391	Rear Handle & Fuel Tank	90	530-015701	Dowel Pin
59	530-027394	Cylindrical Mount	91	530-015724	Screw
60	530-027187	Isolator Limiter	92	530-069216	Line Kit (Bulk 8133)
61	530-015123	Washer	93	530-091878	Fuel Filter Ass'y.
62	530-027888	Reflector	94	530-039129	Grommet
63	530-015702	"C" Clip	95	530-069225	Switch Kit
64	530-010845	Fuel Cap Ass'y. (Incl. "O" Ring)	96	530-027138	Lead Wire Ass'y.
66	530-027191	Bracket	97	530-015717	Screw
67	530-015598	Screw	98	530-027202	Screw Retainer
68	-	Throttle Lock (One piece design)	100	530-024475	Vent Fitting
	530-027139	(Two piece design)	101	530-026119	Check Valve
	530-029666	Throttle Lock Spring	102	530-031111	Hex Key
69	530-024772	Screw	103	530-027339	Vent Plug
70	530-015716	Screw	104	530-025922	Plug-Air Box
71	952-069253	Carb. Cover Winter Kit	105	530-027341	Clamp
72	530-069279	Cylinder Shield Kit (Incl. # 62)	173	-	Instructions Decal Model 358.356281 Model 358.356332
73	530-027178	Carb. Cover	174	-	Repl. Bar & Chain Model 358.356281 Model 358.356332
74	530-015871	Screw		530-027257	Bracket
75	530-027134	Trigger Latch Spring		530-029684	Screw
76	530-027133	Throttle Trigger	177	530-029347	Screw
77	530-027271	Grommet	178	530-015875	Washer
78	530-027121	Bracket	179	530-015810	AV Strap
79	530-069217	Gasket Set	180	530-015562	Strap Retainer Plate
80	530-035201	Carburetor (HDA-49)	181	530-037104	Screw
81	530-023664	Air Filter Plate	182	530-037012	Isolator Ass'y. Kit
82	530-015735	Carb. Mounting Stud	183	530-016015	
83	530-010892	Air Filter Ass'y.	184	530-069384	
84	530-027135	Throttle Lockout			

SEARS CHAIN SAW REPAIR PARTS LIST MODEL 358.356281-2.8/18"
 MODEL 358.356332-3.3/20"

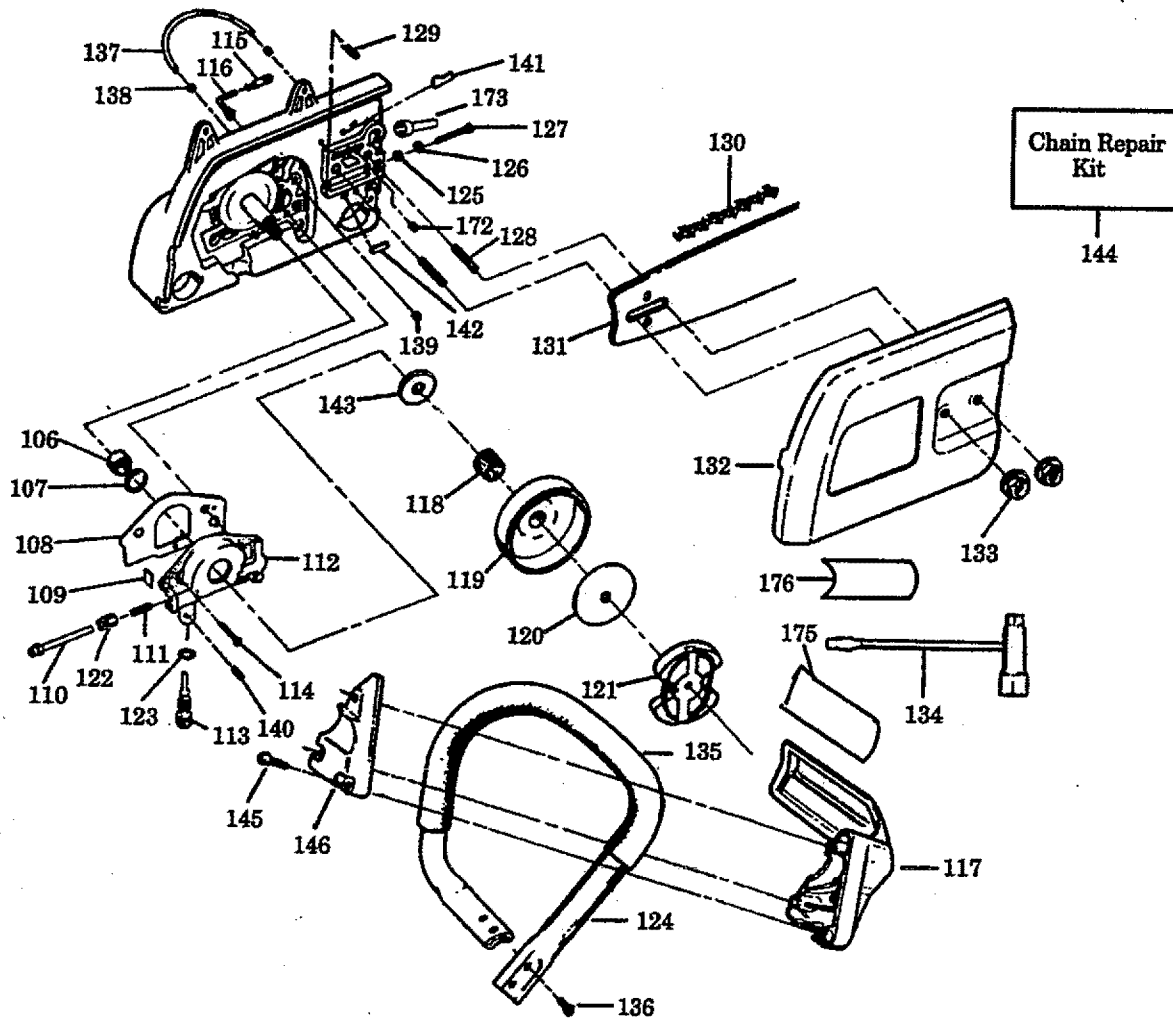

KEY NO.	PART NO.	DESCRIPTION	KEY NO.	PART NO.	DESCRIPTION
106	530-027140	Worm Gear	130	-	Chain
107	530-019147	Seal		71-3634	18"
108	530-069217	Gasket Set		71-3635	20"
109	530-027128	Dust Plug	131	-	Bar
110	530-014204	Plunger		71-36372	18"
111	530-027126	Spring		71-36373	20"
112	530-069218	Oil Pump Kit (Incl. #'s 106, 107, 109, 110, 111, 113, 122, 123 & 140)	132	530-014273	Bar Clamp Ass'y. (Incl. #142)
113	530-015873	Oiler Adjustment Screw	133	530-015445	Nut
114	530-015871	Screw	134	530-031107	Scrench
115	530-027272	Oil Pickup & Filter	135	530-027847	Handlebar Grip
116	530-027192	Oiler Intake Line	136	530-016058	Screw
117	530-024466	Handguard	137	530-021061	Oiler Discharge Line
118	530-032049	Clutch Bearing	138	530-002464	Oiler Discharge Sleeve
119	530-048084	Drum Sprocket	139	530-015422	Tubing Nut
120	530-027161	Clutch Plate	140	530-015752	Oiler Adjustment Pin
121	530-014161	Clutch Ass'y.	141	530-027222	Chain Pad - Top
122	530-027129	Oiler Gear Spur	142	530-027223	Chain Pad
123	530-019079	"O" Ring	143	530-015733	Thrust Washer
124	530-010990	Handlebar Ass'y.	144	530-052085	Chain Repair Kit
125	530-023064	Bar Adjusting Pin	145	530-015509	Screw
126	530-024419	"E" Ring	146	530-024467	Handguard Cap
127	530-015730	Screw	172	530-025539	Impulse Fitting
128	530-015719	Bar Stud	173	530-029236	Crankcase Plug
129	530-015108	Vent Pin	175	530-026849	Kickback Decal
			176	530-027256	Bar Clamp & Fan Hsg. Decal

**SEARS CHAIN SAW REPAIR PARTS LIST MODEL 358.356281-2.8/18"
MODEL 358.356332-3.3/20"**

Carburetor Assembly - #530-035201 HDA - #49

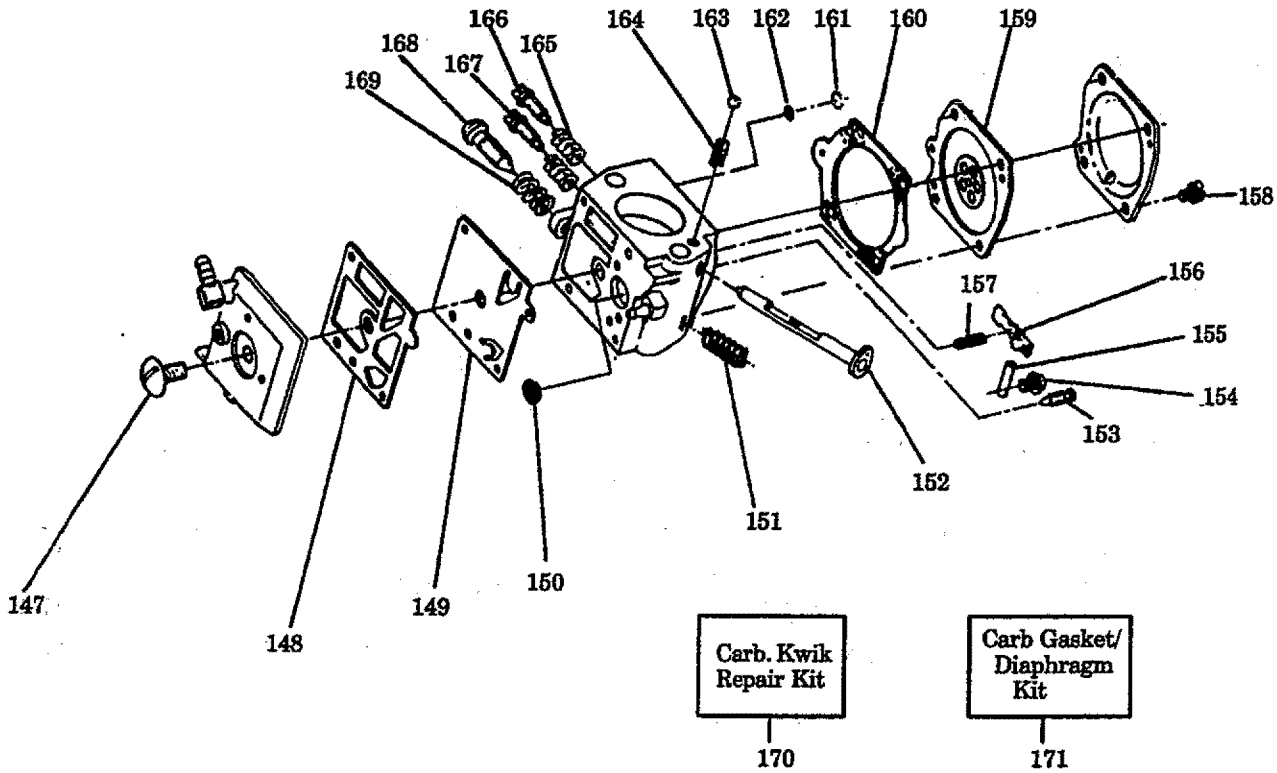

KEY NO.	PART NO.	DESCRIPTION	KEY NO.	PART NO.	DESCRIPTION
147	530-035237	Screw	161	+530-035204	Retaining Ring
148	*+530-035227	Fuel Pump Gasket	162	+530-035248	Check Valve Screen
149	*+530-035229	Fuel Pump Diaphragm	163	530-035226	Ball
150	+530-035249	Inlet Screen	164	530-035240	Spring
151	530-035244	Throttle Spring	165	530-035243	Needle Adjusting Spring
152	530-035216	Choke Shaft & Lever Ass'y	166	530-035245	High Speed Needle
153	+530-035223	Inlet Needle Valve	167	530-035246	Idle Needle
154	+530-035236	Screw	168	530-035238	Idle Adjust Screw
155	+530-035250	Pin	169	530-035242	Idle Adjust Spring
156	+530-035252	Metering Lever	170	530-035209	Kwik Repair Kit(+Indicates Contents)
157	+530-035241	Spring	171	530-035213	Carb. Gasket Kit (*Indicates Contents)
158	530-035239	Screw			
159	*+530-035230	Metering Diaphragm			
160	*+530-035228	Metering Diaphragm Gasket			
				Not Shown	
				+530-035224	Welch Plug
				+530-035225	Plug Cup

QUICK REFERENCE PAGE

*Read and follow all Safety Rules, Precautions, and Operating Instructions.
Failure to do so can result in serious injury.*

SPECIAL SAFETY SECTION	page 3-5
PREPARATION	3-5
1. Wear protective gear — gloves; safety footwear; snug fitting clothing; and eye, hearing, and head protection.	
2. Check for worn, loose, missing, or damaged parts and repair or replace as necessary.	
3. Check the chain for sharpness and tension.	
4. Keep children, bystanders and animals a minimum of 30 feet away from work area.	
5. Plan your sawing operation carefully in advance.	
FUEL AND OIL	9 & 10
1. Eliminate all sources of sparks or flame where fuel is mixed, poured, or stored.	
2. Use 1 part air-cooled, 2-cycle engine oil to 40 parts regular unleaded gasoline.	
3. Use gasoline not over 2 months old.	
4. Mix and pour fuel in an approved, marked container and in an outdoor area.	
5. Move a minimum of 10 feet away from fuel and fueling site before starting engine.	
6. Fill the oil tank each time the fuel tank is refueled.	
STARTING THE ENGINE	11
1. Hold saw firmly with the saw chain free to turn without making contact with any object.	
2. Hold front handlebar with left hand & place right foot through rear handle to stabilize saw.	
3. Use less than the full extent of the starter rope per pull.	
4. Release the trigger after engine starts allowing engine to idle.	
OPERATING THE UNIT	12
1. Cut wood only.	
2. Accelerate the engine to full throttle before entering the cut.	
3. Begin cutting with spur against the log.	
4. Cut only at full throttle.	
5. Release the trigger as soon as the cut is completed.	
6. Stop the engine before setting the saw down after cutting.	
MAINTENANCE	16
1. Adjust or have the carburetor adjusted if the chain moves when the engine idles.	
2. Disconnect spark plug before performing maintenance except for carburetor adjustment.	
3. Check the guide bar for wear each time the chain is sharpened.	
4. Clean the air filter frequently and always after 10 tanks of fuel mixture or 5 hours of operation, whichever is less.	
5. Clean spark arrestor screen at least once for each 25-30 hours of operation.	
6. Take the saw to your Sears Service Center/Department for full clutch inspection after each 100 hours of operation.	
7. Run fuel out of the fuel tank in a safe manner before storing the unit for 30 or more days.	
8. Store saw in a dry place out of the reach of children.	

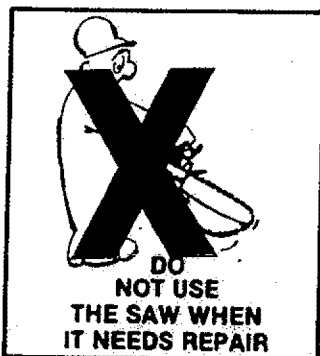

SEARS

Operator's Manual

MODEL NO.
358.356281-2.8/18"
358.356332-3.3/20"

How to Order Repair Parts

**SEARS SERVICE
IS AT YOUR SERVICE**

The Model Number will be found below the top handle with the Serial Number. Always mention the Model Number when requesting service or repair parts for your unit.

All parts listed herein may be ordered from any Sears Service Center and most Sears Stores.

WHEN ORDERING REPAIR PARTS ALWAYS GIVE THE FOLLOWING INFORMATION AS SHOWN IN THIS LIST:

- | | |
|---|------------------------------------|
| 1. The PART NUMBER | 3. The PART DESCRIPTION |
| 2. The MODEL NUMBER
358.356281-2.8/18"
358.356332-3.3/20" | 4. The NAME OF ITEM —
Chain Saw |

If the parts you need are not stocked locally, your order will be transmitted to a Sears Repair Parts Distribution Center for handling.



When you buy merchandise from Sears you get an extra value that nobody else can offer — Sears Service.

Across town or across the country, Sears Service is always near, providing trustworthy, competent service technicians using only Sears specified factory parts.

SEARS / CRAFTSMAN.

CHAIN AND BAR LUBRICANT

Available in Gallons (#71-36554) and in Quarts (#71-36556) at your nearest Sears Store, Catalog Sales Office, or Service Center.



Sold by Sears, Roebuck and Co., Hoffman Estates, IL 60179 USA

PRINTED IN U.S.A.