

Packing List	1
Safety Warnings and Precautions.....	2
Installation Instructions.....	6
Adjustment of Angle and Height.....	9
Connection of Peripherals.....	10
Functions of Keys.....	10
Use of Internal Battery.....	11
Remote Control (Optional).....	12
Basic Operations.....	13
Power-on/Standby.....	13
Touch Operation.....	13
Wireless Network Connection.....	14
Important Statement on Network Service.....	14
Troubleshooting.....	15
Specifications.....	16

Packing List

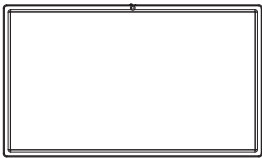

Display screen



Ring decoration strip
(at back cover of
display screen)

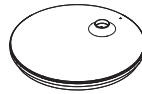

Base

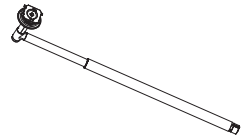

Lifter



User Manual



Power cord

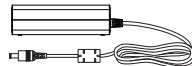

Power adapter



Screws



AAA

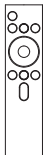

Battery
(optional)

Remote control
(optional)





If any of the above items is missing, please contact your product dealer.

Personal safety factors have been taken into account during design of the product, and the product has been tested strictly before delivery. However, improper installation and use could result in electric shock, fire or other hazards. To ensure its safe use, prolong its service life and bring its best performance into full play, please read and understand all operating instructions and nameplate indications and observe the following safety precautions carefully before using the product, and keep this manual properly for future reference.



Caution: In order to reduce the risk of electric shock, please do not remove the cover plate (or back plate). The product does not contain any user-serviceable components. Please consult qualified service personnel for service arrangement.

 There is “dangerous voltage” without insulation protection in the product housing, and the voltage strength is high enough to pose the risk of electric shock.

 Warning	May result in casualties		Indicate the behaviors that must be prohibited
 Caution	May result in personal injury or property losses		Indicate the operations that must be performed

- In any of the following situations, turn off the product immediately, disconnect the power plug from the power socket and contact authorized professional service personnel for repair.
 1. The product produces abnormal sound or smell or has any other obvious abnormality.
 2. The power cord or power plug is damaged or worn.
 3. The product gets damaged due to fall, strike or impact. Any liquid flows or foreign object falls into the product.
- In case of any flammable gas leakage, do not connect/disconnect the power plug of the product or any other electrical appliance but close the leaky valve and open the doors and windows immediately.

Warning

-  ● This product can only use the power supply of the type indicated on its nameplate. If you are not sure about the type of power supply in use, please consult your product dealer or the local power supply bureau.
- The power cord uses a 3-prong plug with ground protection. For the sake of safety, please use a 3-pin outlet with ground protection, and ensure that the ground terminal is well grounded.
- Do not disassemble the adapter or power cord, which may cause fire or electric shock.

Warning

- Please place the adapter carefully to avoid drop or impact.
- Impact could cause damage of the product.
- Please place the product on an even ground. Do not place the product at an unstable or inclined position; otherwise, drop and damage or even fire could be caused, further resulting in severe personal injury or death.
- Always use the stand and installation method recommended by the manufacturer.
- Never allow children to climb up the product; otherwise, the product will topple over, resulting in severe injury.
- To avoid the risk of swallow, keep small accessories beyond the reach of children.
- Do not put any fabric or other material between the product and the ground.
- Do not place any article on the product.
- Do not place the product:
 1. in an environment that is too damp, hot, cold or dusty or exposed to direct sunlight;
 2. in an environment where flammable or explosive substances are stored or used;
 3. in an environment where there are combustible or corrosive gases;
 4. in or near a bathroom, kitchen or other working environment with high humidity or with source of heat, steam or oil fume.
- Do not use any damaged or inappropriate power outlet. Keep a good contact between the power plug and the power outlet.
- Protect the power plug and the power outlet against dust and metal attachments.
- Do not damage the power cord:
 1. Do not remodel the power cord;
 2. Do not put heavy objects on the power cord;
 3. Keep the power cord away from heat sources;
 4. Do not pull the power cord when disconnecting the power plug. Please hold the power plug instead of the power cord.
- Paralleling too many power plugs to one power outlet may cause fire due to excessive power consumption.
- To avoid the risk of electric shock or fire, keep the product away from naked flames (like burning candles).
- Do not put any container with water on the product, or water drops or splashes could cause electric shock or fire.
- To avoid the risk of short circuit, product damage and electric shock, do not put any sharp object, metal or liquid into or allow them to contact the ventilation holes or signal connectors.
- The ventilation holes in the housing are designed to protect the internal components against overheat and ensure their long-term reliable work. The product should be placed without blocking such ventilation holes. Always leave a space of at least 4" or 10cm around the product to guarantee good ventilation.

Warning

- ⊘ ● The base of the product contains an internal lithium battery. Please take care during use!
 - If the battery leaks, please stop using it immediately to avoid contact with your skin and eyes. Carelessness in this respect could result in loss of eyesight or burn injury. If any part of your body in contact with the leaking liquid shows any abnormality, please wash it with sufficient clean water, and also seek medical advices.
 - Please dispose of the battery correctly. Improper battery disposal could pose the risk of explosion or fire. The guideline for battery disposal varies with the country and region.
 - Do not expose the product (especially the lithium battery) to electricity.
 - Do not expose the product to flame, electric heater or direct sunlight. Otherwise, electric shock, injury or fire could be caused.
 - To charge the battery, do not use any power supply or circuit beyond the specified range. Otherwise, the risk of battery damage or fire will be caused.
 - Be careful when using the lithium battery since the risk of fire or explosion exists.
 - Clean the charging port using a soft cloth. If dirt or other foreign object exists on the charging port, the battery cannot be charged normally, or fire can be caused.
 - If the battery is fully discharged and left unused for a long period of time, it is possible that the battery cannot be charged or that the battery life is shortened.
 - Do not remove, disconnect, disassemble or short-circuit the battery. Otherwise, electric shock, injury or fire could be caused.
 - Do not replace the battery with one of wrong model that could deactivate the safety protection. Using a battery of wrong model poses the risk of explosion.
 - Do not throw the battery into the fire or heating furnace, or mechanically extrude or cut the battery; otherwise, explosion could be caused.
 - Do not place the battery in an environment with extremely high temperature that could result in battery explosion or leakage of flammable liquid or gas.
 - Do not place the battery under extremely low atmospheric pressure that could result in battery explosion or leakage of flammable liquid and gas.
- ⊘ ● To avoid the risk of electric shock, do not touch the power plug with wet hands.
- ⚠ Do not use the product during rainstorm or lightning. Disconnect the power plug immediately to protect it against lightning stroke.
- ⊘ ● To avoid the risk of electric shock or fire, do not disassemble the product in any way. All repairs should be referred to professional technicians.

Caution

- Please tidy the wires and cables connected to the product to avoid trip-over, pull or grab.
- Please ensure that no juveniles play, disport, chase each other, run or jump around the product, or push, drag, touch or impact the product in any way, thus to avoid topple-over or damage of the product.
- Please ensure that no pets play, disport, run or jump around the product, or push, drag, touch or impact the product in any way, thus to avoid topple-over or damage of the product.
- Do not place the product on a carpet or cushion.
- Take care to protect your hands, feet, hair or clothes from getting stuck in the wheels.
- Do not push or kick the product.
- Do not ride on the product as it was a foot rest.
- Do not use hard objects to rub or strike the screen or twist or press it forcibly.
- Disconnect the power plug before cleaning the product. Clean it with a soft cloth without using any industrial chemical. Take care to prevent the ingress of any foreign object into the product. Improper cleaning (e.g., cleaning solution, water) may cause damage to the appearance, erase the printed information or damage the internal components (if the cleaning solution or water flows into the product) and cause display failure.
- Disconnect all cables before changing the position of the product. To avoid the risk of fall, move the product slowly.
- To avoid the risk of dew and fault, do not use the product immediately after moving it from a low-temperature place to a high-temperature place.
- Please do not place the product near any strong electromagnetic field; otherwise, it will be subjected to electromagnetic interference and get damaged.
- Please do not place the product directly facing an air conditioner; otherwise, dew can be formed on the panel inside the product, further resulting in fault.
- If the leakage splashes onto your skin when the LCD screen is broken, rinse the skin with clean water for 15min and seek medical advices. Grab the four corners and hold the bottom side rather than exert pressure on the front panel when moving the product with hands.
- If the product keeps displaying one image or there is any still text or icon in a moving image during a long time, an “afterimage” will stay on the screen and last long after the product is turned off. Such fault is not covered by the warranty.
- Watch the screen in a healthy way:
 1. Please watch the screen under proper light condition; insufficient light or long continuous use may damage your vision.
 2. Please adjust the volume to protect your hearing from being impaired by excessively high volume.

Caution

- Turn off the product and disconnect the power plug before leaving the product unused for a long time for any reason.
- Cut off power supply to the product by pressing the [ON/OFF] button on the base of the product and also disconnecting the power plug.
- The power plug or appliance coupler acting as the make-and-break device should be easy to operate.
- Insert the power plug into the power outlet reliably. A loose connection may cause sparks or fire.
- To better provide services, all technical specifications contained in this manual and on the carton are subject to change without further notice. If there is any difference between this manual and any actual operation, such actual operation shall prevail.

Installation Instructions

Installation of Base and Lifter

Warning

- During assembly, please lock the mount fixing screws since drop of the mount could result in product damage or personal injury.
- Since the product is somewhat heavy, the cooperation of at least two persons is needed during unpacking and installation.
- When assembling the product, do not apply any foreign matter (e.g., oil, lubricating oil) on the screws.
- After installation of the product, do not remove the cable holder and screws.
- During daily use, please grab the middle of the lifter and ensure that the product moves in upright position. Do not tilt the product since the topple-over risk will be caused, further resulting in fault of the product or personal injury.

Instructions for Installation of Lifter

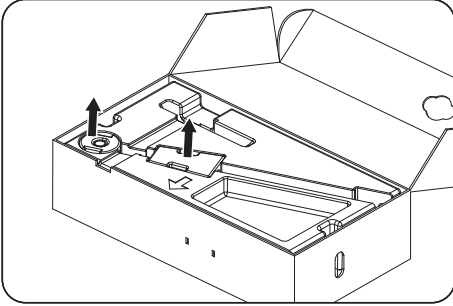

1. Unpack and take out the top protective pad.

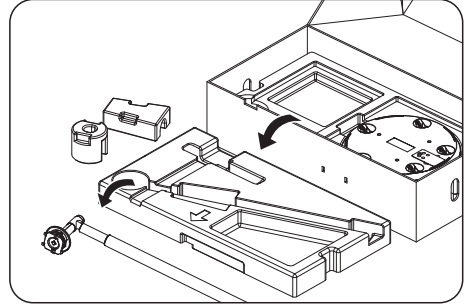

2. Take out the cushion pad and the lifter.

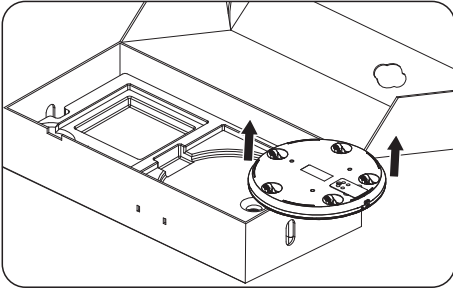

2. Take out the base.

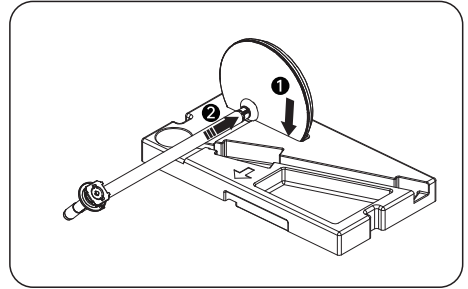

4. Place the base in the slot.

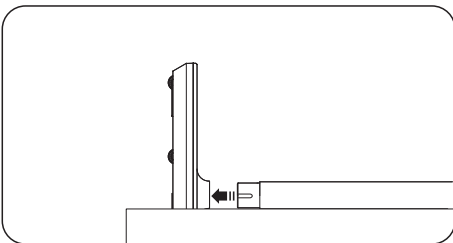

5. Install the lifter to the base by aligning it with the slot position.

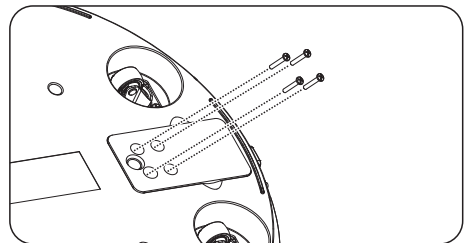

6. Align the screws with the screw holes, and then fasten the screws.

Instructions for Installation of Display Screen

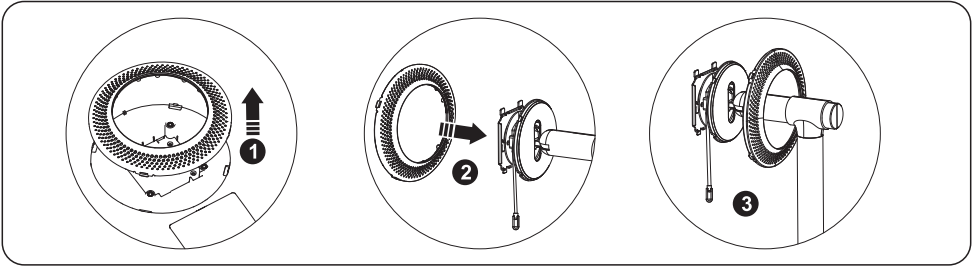

7. Before taking the display screen out of the package, first take out the trim ring at the back; then put the trim ring through the lifter.

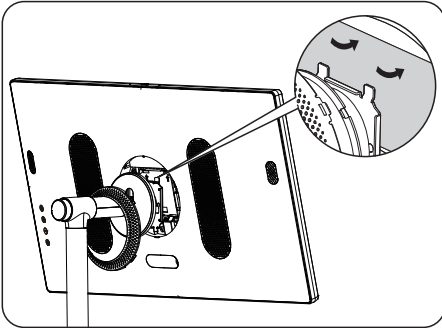

8. Tilt the display screen face up, and install it by alignment with the clipping position.

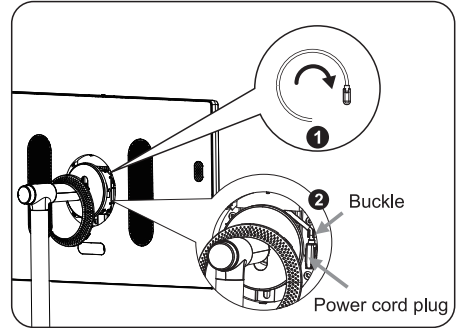

9. Wind power cable around the lifter clockwise, and insert power cable plug, then arrange power cable and clamp it into the buckle.

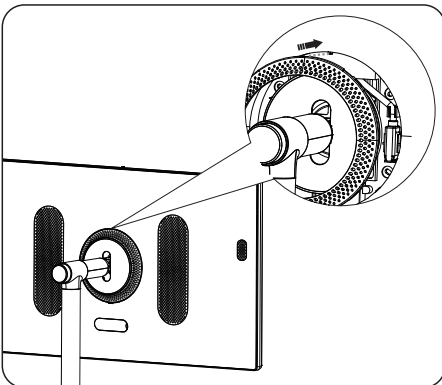

10. Align the locating hole of trim ring with the locating stud on the rear shell of the screen, and simply press to finish installation.

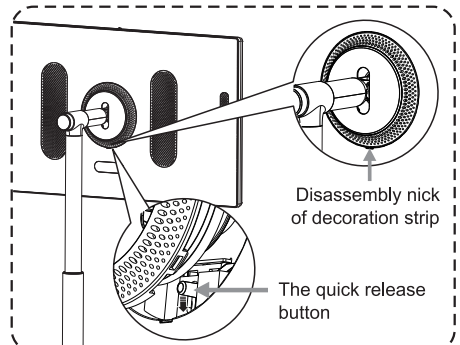

Attention: During disassembly, it is needed to press the quick release button to remove the display screen from the lifter.

Adjustment of Angle and Height

The height and angle of the product can be adjusted to get a comfortable watching experience.

Attention: Some applications do not support vertical display.

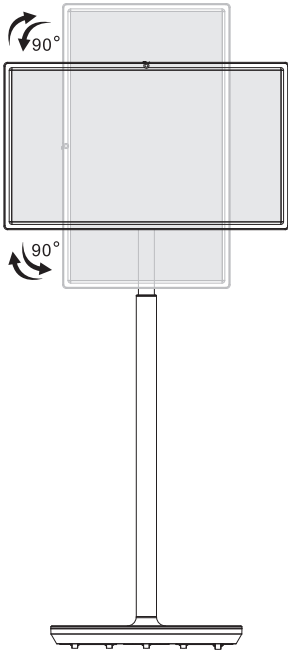

Forward angle: $20\pm 3^\circ$
Backward angle: $20\pm 3^\circ$

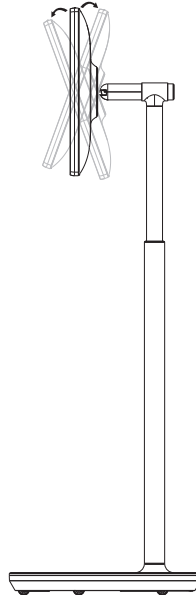

The height of the lifter is adjustable within $190\pm 10\text{mm}$

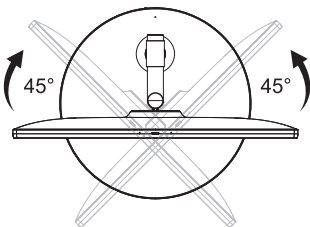
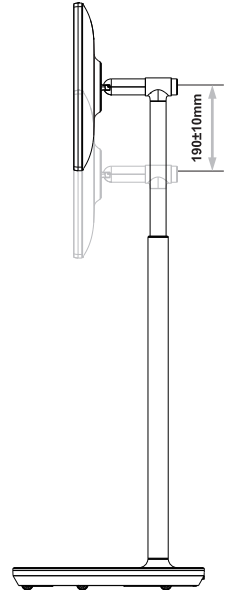

Caution

- Do not rotate the product at an angle beyond the limit or beyond the maximum adjustable range of height.
- Do not let your hands or fingers get stuck in the stand or height adjustment area.

⚠ Warning: Cut off power supply before connecting/disconnecting any cable.

Note:

1. Open the port dust cover, and connect to the corresponding port as per need.
2. The maximum resolution of HDMI 2.0 is 2160@60Hz.

Attention:

- If it is the first time to turn on the product, please first connect the power adapter so that the product can be turned on normally.
- Please connect the product to the power adapter, then insert the power plug of the product to the power outlet.

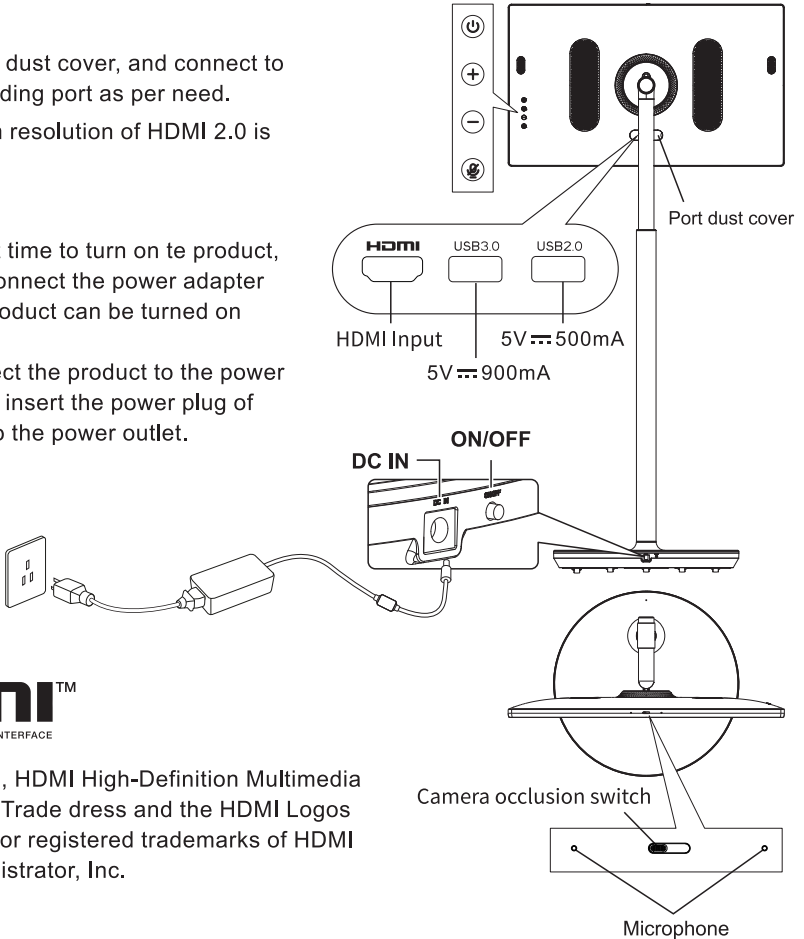

The terms HDMI, HDMI High-Definition Multimedia Interface, HDMI Trade dress and the HDMI Logos are trademarks or registered trademarks of HDMI Licensing Administrator, Inc.

Functions of Keys

ON/OFF: Turn on or off the product.

⏻ : In standby mode, press ⏻ key to turn on the product. During normal working, press ⏻ key, and the screen will show the auxiliary menus, then you can operate as per need.

⊕ : Increase the volume.

⊖ : Decrease the volume.

🔇 : Turn the microphone on or off.

Use of Internal Battery

The base of the product contains an internal battery which can supply voltage to the product for some time when no other power supply is connected. The indicator light changes its color among green, yellow, and red according to the remaining battery level.

The indicator light is on during charging; after battery is fully charged, the green light flashes.

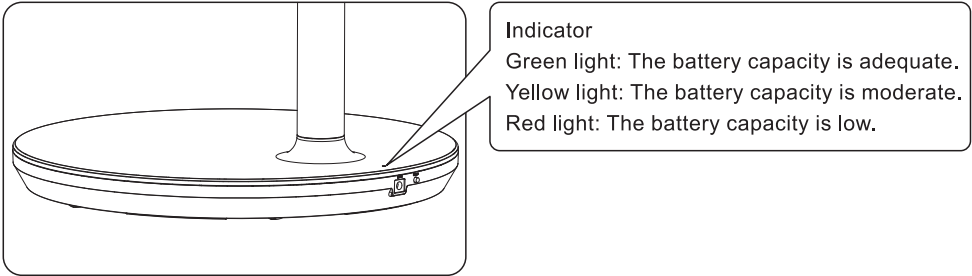

Attention:

- The battery life and service time after charging reduces in proportion to the service period of the product.
- The battery cannot be charged in extreme environments.
- In standby mode, the remaining battery capacity reduces naturally.
- To prolong the battery life, it is suggested to charge the battery after use for some time instead of keeping the battery fully charged.
- Maintaining the battery capacity at 50% helps to prolong the battery life.
- The service time may vary with various factors, such as connected devices, operating temperature, service period and user settings. Therefore, the actual time may vary with the service condition.

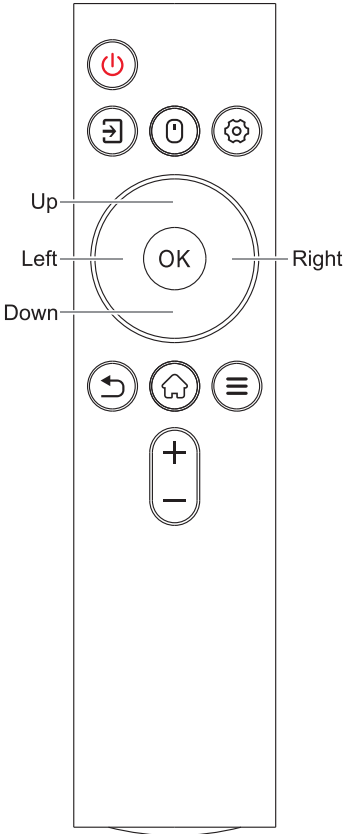

How to Install Batteries in the Remote Control

Remove the battery compartment cover; install two AAA (No.7, 1.5V) batteries, and ensure that the terminals of the batteries are consistent with the “+” and “-” symbols in the battery compartment of the remote control.







Instructions for Pairing Bluetooth Remote Control

The remote control can be used only after it is successfully paired.

1. Click “**Settings > Bluetooth > Remote control pairing tutorial**” on the screen.
2. Simultaneously press and hold the  key and  key on the remote control, and release the keys when the indicator light on the remote control blinks. At this moment, it enters the auto pairing state. Keep a distance of less than 20cm between the remote control and the screen, and wait for the screen to show the pairing successful prompt.
3. If successful pairing cannot be achieved, please retry.

Description of Control Keys on the Remote Control

 In “Go out screen” mode, press  key to light up the screen. During normal working, press  key, and the screen will show the auxiliary menus, then you can operate as per need.

 Switch the signal source.

 Enable or disable the mouse function.

 Open the Settings menu.

Up/Down: on the smart interface, press **Up/Down** key to open or close drop-down menu; on the “**Settings**” interface, simulate swiping the screen up/down.

Left/Right: when the mouse function is enabled, it has no effect; When the mouse function is off, in the smart interface, the simulated touch swipes the screen left and right.

 Confirm the operation.

 Go back to the previous menu.

 Go back to the home page.

 Not working

 Press + to increase the volume.



 Press - to decrease the volume.

Precautions for Use of Remote Control

- Do not place objects between the remote control and the remote control sensor window.
- Strong lighting affects the remote control sensor window, please adjust the angle of lighting or the product, or operate the remote control near the remote control sensor window.
- Do not expose the battery to overheating environments such as sunlight or fire, or charge, heat or incinerate, mechanically crush or cut the battery, as this may cause an explosion.
- Do not place the battery in an environment with extremely high temperature or extremely low air pressure that may cause the battery to explode or leak flammable liquids or gases.
- If the remote control is not in use for a long time or the batteries are dead, please remove the batteries.
- Please do not use batteries of different types. It is not allowed to use old and new batteries together; the batteries should be replaced in pair.
- The waste batteries contaminate the environment, please dispose the waste batteries pursuant to relevant regulations on environmental protection.

Basic Operations

Power-on/Standby

Connect the power cord, and press the [ON/OFF] key on the base to turn on the product. In power-on state, press the  key on the rear shell, then the screen will show the auxiliary menus. Click , then the product will enter standby. Press [ON/OFF] key to turn off the product.

Touch Operation

- Click: Tap on the screen.
- Click and hold: Tap on the screen for 2s or longer.
- Swipe: Swipe on the screen up, down, left and right.
- Drag: Tap and hold the target (e.g., an application) to be moved, then swipe to the desired position.
- Open/close: Place two fingers on the screen, then open or close these fingers to zoom in or out the content displayed on the screen.

Click "**Settings > Universal > Gesture Navigation Tutorial**" to show the gesture guide in the interface.

Attention:

- Whether the displayed content supports the zoom in/out function is related to the application. Please operate according to the actual condition.
- Avoid pressing the screen with force; where necessary, simply use your fingertip to tap on the desired item. If you wear gloves or use your fingernail to touch the screen, it is possible that the product cannot respond and be operated normally.
- If the screen is a little wet or too damp, the sensor cannot work normally when touching it.

Wireless Network Connection

Click “**Settings > Wi-Fi**”, and turn on Wi-Fi; the system will start searching and list the wireless network signals available. Click the network to be connected. The  icon beside a network indicates the network is encrypted; the product can be connected to the network only after you enter the correct password.

Remark: More system settings can be done under “**Settings**” as per need.

Important Statement on Network Service

All contents and services obtained from the product are owned by third parties and protected by copyright, patent, trademark and/or other intellectual property laws. These contents and services are only for your personal non-commercial purposes, which shall not be used in a way not authorized by the content owner or service provider.

Under no circumstance shall our Company be liable for any direct, indirect or unexpected losses or damages arising from your or any third party's access to any contents or services or any information or third-party software through this product.

Third-party services may be subject to change, removal or discontinuation without prior notice. Our Company does not represent or warrant that some services or contents will remain accessible at any time.

Our Company will not be responsible for any service related to these contents and services, or assume any liability for customer service. For any question or service request about these contents and services, please directly contact your content or service provider.

Symptom	Solution
The screen does not display anything; there is no sound, and the indicator does not turn on.	<ol style="list-style-type: none"> 1. Check whether the product has been turned on. 2. Check whether the power cord has been connected.
The product shuts down suddenly.	<ol style="list-style-type: none"> 1. It is possible that the internal battery runs out; please connect the power cord. 2. Check whether the [ON/OFF] key on the base is in OFF position. 3. Check whether the auto shutdown function is activated at the set time point. 4. If the battery overheats, the product will shut down automatically for self-protection.
There is no signal when an external HDMI device is connected.	<ol style="list-style-type: none"> 1. Press the [ON/OFF] key to restart the product. 2. Reconnect the HDMI cable. 3. When the product is on, restart the HDMI device.
There is no sound.	Adjust the volume to a proper level.
Short remote control distance, malfunction of remote control	<ol style="list-style-type: none"> 1. Move the object away to avoid blocking the remote receiver. 2. Replace the battery.
Network cannot be connected	<ol style="list-style-type: none"> 1. Ask the network administrator for the available network IP addresses and other parameters. 2. Check whether the network cable is connected normally. 3. Consult the network service provider.
The network is very slow when playing videos online	<ol style="list-style-type: none"> 1. Please upgrade your network bandwidth to a higher one. 2. Please try other VOD addresses to get better resources.
The product gets stuck, crashes or cannot be operated.	Press [ON/OFF] button on the base to turn off. Reboot after 1-2min.

Specifications

27"

Resolution	1920×1080
Built-in system	Android 13 OS
Speaker output power	2×5W(Treble)+2×5W(Alto and bass)
Power supply	19V \equiv 3.42A, 65W
Rechargeable lithium battery	14.4V / 9500mAh (136.8Wh)
Charging time	261 min (Typ) (Play online videos)
Battery life	356 min (Typ) (Play online videos)
Power adapter	Input: 100-240V~, 50/60Hz Output: 19V \equiv 3.42A
Environmental requirements	Operating temperature: 0°C ~ +40°C Charging temperature: 0°C ~ +45°C Operating humidity: 0% ~ 65%, non-condensing Storage humidity: 0% ~ 60%, non-condensing Operating altitude: ≤ 3000 m

Dimension (L×W×H) and Weight

Overall dimension (without base)	634X374X46mm
Overall dimension (with base)	634x426x1306mm
Net weight of device	18.09kg

Remark: View the product information on the label affixed to the base of the product.

FCC Caution: Any changes or modifications not expressly approved by the party responsible for compliance could void the user's authority to operate this equipment.

This device complies with Part 15 of the FCC Rules. Operation is subject to the following two conditions:

- (1) This device may not cause harmful interference, and
- (2) this device must accept any interference received, including interference that may cause undesired operation.

This equipment should be installed and operated with minimum distance 20cm between the radiator and your body.

NOTE:

This equipment has been tested and found to comply with the limits for a Class B digital

device, pursuant to Part 15 of the FCC Rules.

These limits are designed to provide reasonable protection against harmful interference

in a residential installation. This equipment generates, uses and can radiate radio frequency energy and, if not installed and used in accordance with the instructions,

may cause harmful interference to radio communications.

However, there is no guarantee that interference will not occur in a particular installation.

If this equipment does cause harmful interference to radio or television reception,

which can be determined by turning the equipment off and on, the user is encouraged to

try to correct the interference by one or more of the following measures:

- Reorient or relocate the receiving antenna.
- Increase the separation between the equipment and receiver.
- Connect the equipment into an outlet on a circuit different from that to which the receiver is connected.
- Consult the dealer or an experienced radio/TV technician for help.