

Description:

ROBINHOOD WALL CANOPY CURVED GLASS 90CM VETRO

Model Numbers:

RWV3CL6G, RWV3CL9G

















Product may vary slightly from the picture (RWV3CL9G pictured)

Pre-installation

Thank you for purchasing a quality Robinhood rangehood. Robinhood has a high standard of quality control and every rangehood is tested and approved before it leaves the factory.

Important:

-  Please read the entire instructions before installing the rangehood, always switch power off prior to installation. All electrical work must be done by a registered electrician in accordance with local and national electrical codes as applicable. For your safety, this product must be earthed.
-  The power socket must be accessible and enable the end user to isolate the rangehood from the power for the purpose of internal cleaning or maintenance.
-  A power outlet should be within 1500mm of the power cord exit from the rangehood.
-  The canopy hood is not intended for use by persons (including children) with reduced physical, sensory or mental capabilities, or lack of experience and knowledge, unless they have been given supervision or instruction concerning use of the appliance by a person responsible for their safety
-  Children should be supervised to ensure that they do not play with the appliance.
-  There shall be adequate ventilation of the room when the rangehood is used at the same time as appliances burning gas or other fuels.
-  There is a fire risk if cleaning is not carried out in accordance with the instructions. You must read the details concerning the method and frequency of cleaning.
-  Do not flambé under the rangehood.
-  Exhaust air must not be discharged into an existing flue which is used for exhausting fumes from appliances burning gas or other fuels.
-  The minimum distance between the hob surface and the lowest part of the rangehood is 600mm. This distance shall be at least 650mm, if the rangehood is installed over a gas hob. If the instructions for the gas hob specify a greater distance, this has to be taken into account.
-  Attention should be given to ensure that any applicable regulations concerning the discharge of exhaust air is fulfilled. If re-circulating, ensure that the side outlet grilles on the upper chimney are not obstructed. Even a partial obstruction will restrict the efficiency of the rangehood.
-  Stainless steel is very easily damaged during installation if abraded or knocked by tools. Protect the rangehood with the cardboard box or plastic bag during installation.
-  Check the contents of the packaging, check all electrical functions of the canopy before installation. Canopy is heavy. Please ensure adequate care when installing to prevent personal injury.
-  CAUTION: Accessible parts may become hot when used with cooking appliances

Pre-installation

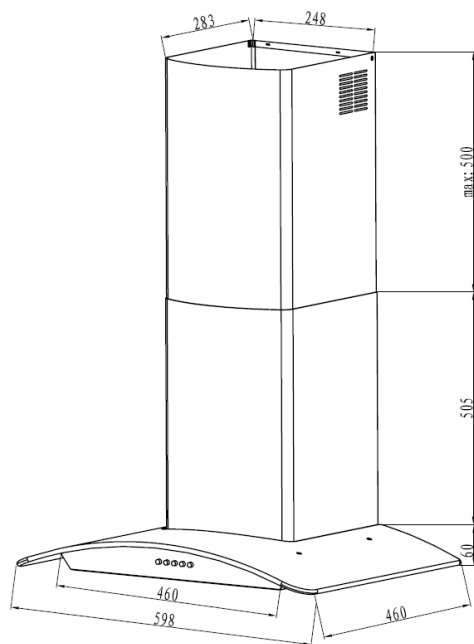

RWV3CL6G

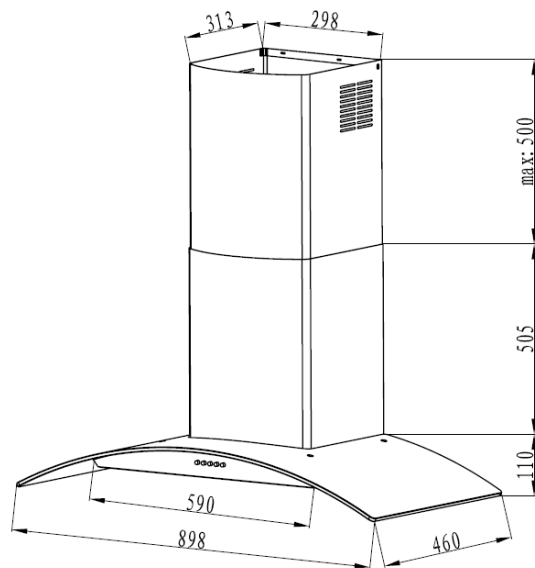

RWV3CL9G

- The canopy hood is designed for 2400mm-2700mm** ceilings.
- **For 2700mm ceiling height, the hood must be installed at 750mm above standard 900mm height bench top
- The chimney is telescopic and is designed for hood installations between 650 to 750mm above the cooking surface.
- Ascertain the desired installation height of the canopy hood.
- Any installation above 750mm will compromise the extraction performance.
- The air outlet from the motor requires 150mm round ducting which requires 170mm diameter hole in the ceiling.

A=650mm(electric cook top) min
 A=650mm(gas cook top) min
 B=305mm
 C=220mm

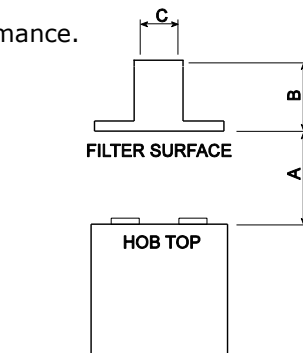

Contents of packaging:

- 1 x rangehood
- 1 x packet of fasteners and wall plugs
- 2 x chimney pieces (upper and lower)
- 1 x chimney bracket
- 1 x Installation and Operating Instructions

Typical equipment required:

- electric drill and screwdriver
- tape measure and spirit level
- step ladder
- duct tape (if ducting)
- jig saw (if ducting)
- ladder (if ducting)

Ducting Options

The method of ducting should be carefully considered before installing the rangehood. The guide below recommends the ducting kit to use for all common ducting configurations - through the top of the home (for the roof and soffit) and through the rear of the home. 150mm round ducting should be used in conjunction with this model rangehood. Alternatively this rangehood can be operated in recirculation mode (Pg.6 Recirculation mode).

The highlighted area in the table below gives the recommended Uniduct Kit numbers for different mounting and outlet options.

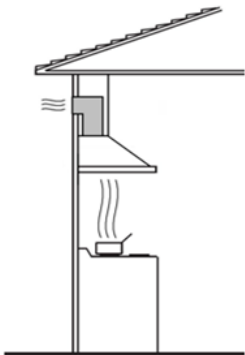
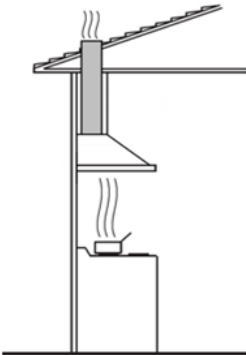
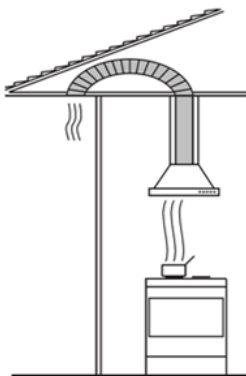
Duct mounting option			
	Rear	Top (roof)	Top (soffit/eave)
			
Uniduct item numbers			
150mm diameter round outlet	UTWSE150	UHRS150	USSR150

Extra lengths and/or bends may be required, depending on the length required and whether there is any structural material in the way, e.g. rafters.

Please note that this chart is designed as a guide. Please consult Robinhood customer services if unsure. For NZ phone 0800 760 667 or www.robinhood.co.nz. For AUS phone 1800 648 556 or www.robinhood.com.au.

Installation

Control Panel

Timer switch

Canopy hood will remain on a low, mid or high speed for 15 minutes to clear away all residual cooking odours before switching off automatically

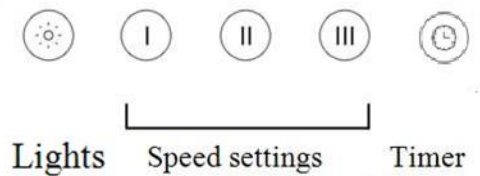

Wall / ceiling preparation

Recirculation

For recirculation, do not cut 170mm hole and purchase a charcoal filter.
For other accessories, parts and service, please contact your local supplier or approved service agent

Ducted

For ducted installation, it is recommended you use 150mm diameter rigid / semi rigid ducting this will require a 170mm hole in the ceiling / wall.

Before drilling any holes check the area behind the surface to be drilled is clear of any electrical cables, pipes etc.

Note:

Fixing to a solid stud is recommended, Rangehood is over 20kg

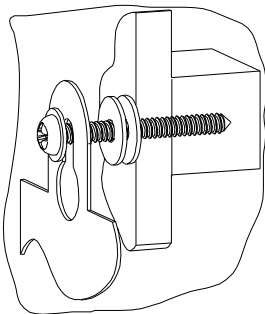
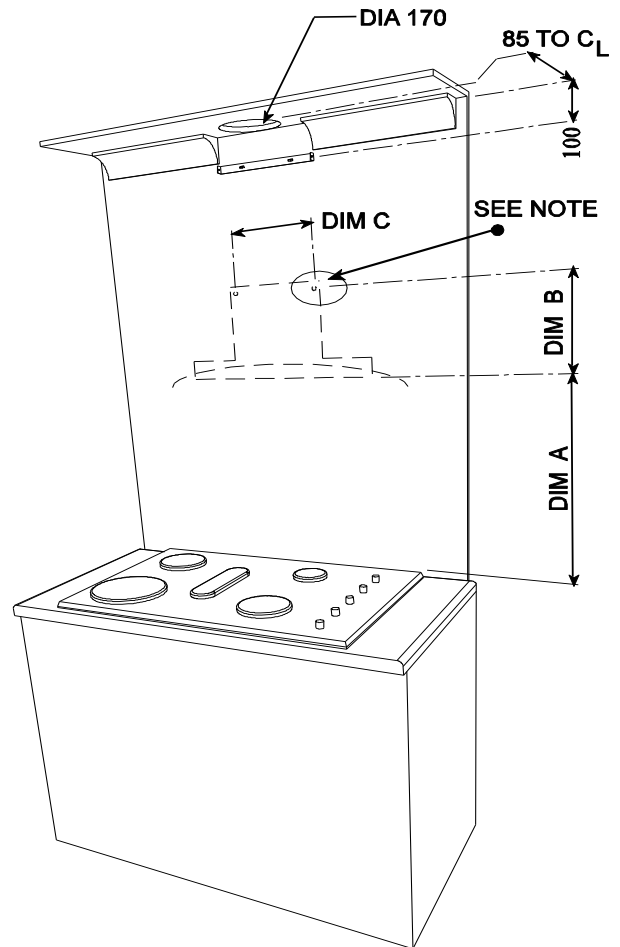

Installation & Hardware

Hardware Provided:

4pcs screws ST5x40 (40mm), 2pcs screws M3x12 (12mm), 4pcs anchor wall plug, 4pcs washers

1. Pre drill pilot hole 3mm diameter at dimensions C and B.
60cm hood; B=305mm and C=170mm to centre of bracket.
90cm hood; B=310mm and C=230mm to centre of bracket.
2. Loosely fix 2x mounting screws (ST5x40, 40mm) and 2x washers in position, drilling into 2x anchor wall plugs (supplied). Check with a spirit level across the washers to ensure they are level.
3. Mark the position of the decorative chimney at the ceiling and wall. Cut the cornice moulding away if required, to enable the chimney to fit flush against the wall and ceiling.
4. Mark and cut out the hole in the ceiling / wall to fit the ducting. (170mm dia.) This is positioned centrally above the canopy hood and 110mm from the wall. (For ceiling option)
5. Using 2x mounting screws (ST5x40) 2x washers, and 2x anchor wall plugs (supplied), fix the chimney bracket to the wall, 100mm below the ceiling checking that it is aligned with the hood.
6. Remove the protective plastic covering from all parts including the filters. Fit the canopy hood on the mounting screws, tighten screws. Plug in the power cord to the supply and check the function of the canopy hood. Connect and secure the ducting (use duct tape if required).
7. Assemble the top chimney to the chimney bracket and fix using the 2x M3x12 screws supplied, then assemble the bottom chimney to the canopy hood and fit into the glass recess.
8. Remove transport tape that holds the oil cup in place under the motor unit and fit the filters.

 **WARNING:** Failure to install the screws or fixing device in accordance with these instructions may result in electrical hazards!

Cleaning and maintenance

Particular care must be taken with the aluminium filters which must be periodically cleaned (at least every two months). You can wash them either by hand using hot soapy water or in the dishwasher using mild detergent.

Note- some discolouration of the frame may occur.

Caution: Never use abrasive or oil based liquid cleaners.

To clean the stainless steel and glass components of the appliance use mild detergent and warm water. In areas of high humidity and coastal environments cleaning should be carried out frequently.

In the case of charcoal filters (2517 or 2619), these are disposable items and it is recommended that these be replaced every 2-4 months depending on the use of the canopy hood.

LED bulb replacement

1. Switch off the power to the canopy hood and allow the bulb to cool.
2. Use a small bladed screwdriver to pop out the light assembly, taking care not to damage the surrounding material.
3. Unplug the Assembly from the wiring.
4. Plug in the new assembly.
5. Push the light assembly back into place.

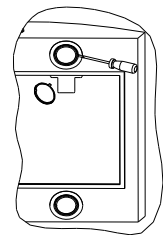

Optional accessories:













Charcoal filter	2517 (Twin Pack for RWV3CL9G) or 2619 (Single for RWV3CL6G)	
Chimney Extension	2200 – 10ft RWV3CL6G 2202 – 10ft RWV3CL9G	2201 – 12ft RWV3CL6G 2203 – 12ft RWV3CL9G

For other accessories, parts and service, please contact your local supplier (Refer to the Warranty Certificate).

Product approvals and ratings

Product rating	223W, 220-240 Volt,50 hertz
Electrical approval AS/NZS	60335.2.31:2004 + A1 + A2 + A3 + A4
EMC AS/NZS	CISPR14:2001
Performance tested	IEC61591

Important safety information

-  **The canopy hood is not intended for use by persons (including children) with reduced physical, sensory or mental capabilities, or lack of experience and knowledge, unless they have been given supervision or instruction concerning use of the appliance by a person responsible for their safety.**
-  **Children should be supervised to ensure that they do not play with the appliance.**
-  **There shall be adequate ventilation of the room when the rangehood is used at the same time as appliances burning gas or other fuels.**
-  **You must read the details concerning the method and frequency of cleaning.**
-  **There is a fire risk if cleaning is not carried out in accordance with the instructions.**
-  **Do not flambé under the rangehood.**
-  **Exhaust air must not be discharged into an existing flue which is used for exhausting fumes from appliances burning gas or other fuels.**
-  **The minimum distance between the hob surface and the lowest part of the rangehood is 600mm. This distance shall be at least 650mm, if the rangehood is installed over a gas hob.**
-  **If the instructions for the gas hob specify a greater distance, this has to be taken into account.**
-  **Attention should be given to ensure that any applicable regulations concerning the discharge of exhaust air is fulfilled.**
-  **If the supply cord of this equipment is damaged, it must only be replaced by the manufacturer or its service agent or a similarly qualified person in order to avoid a hazard.**
-  **CAUTION: Accessible parts may become hot when used with cooking appliances**

Warranty Certificate (Australia)

Terms and Conditions

If you are a consumer under the Australian Consumer Law, our goods come with guarantees that cannot be excluded under the Australian Consumer Law. You are entitled to a replacement or refund for a major failure and for compensation for any other reasonably foreseeable loss or damage. You are also entitled to have the goods repaired or replaced if the goods fail to be of acceptable quality and the failure does not amount to a major failure

1. Shiro Australia Pty Limited ("Shiro") also warrants the following Robinhood products against manufacturing defects and faulty materials, under normal use and subject to the exclusions in this certificate, for a period of:

Rangehood, Ovens, Cooktops, Dishwashers - 24 months from date of original purchase for domestic use.

Uniduct – 12 months from date of original purchase for domestic use.

Ironing centre – 12 months from date of original purchase for domestic use.

Taps, including Pull-out and Mixer taps – 5 years on parts only from date of original purchase domestic for use, 24 months parts and labour from date of original purchase for domestic use

Sinks sets– 5 years on stainless steel sink including draining bench from date of original purchase for domestic use, 6 months on all stainless steel accessories, including wire rack, colander and tray from date of original purchase for domestic use.

Laundry Tub - 5 years on stainless bowl, 24 months on Tap, Cabinet and other components from the date of original purchase for domestic use.

"Original purchase", when used in this certificate, means purchase by the customer directly from Robinhood or one of its approved suppliers.

2. This warranty is limited to the repair or replacement, at our option, within the warranty period of any component part which we at our discretion determine to contain faulty materials or a manufacturing defect in breach of this warranty. This warranty is subject to terms and conditions set out in this certificate.

3. The warranty only applies within Australia.

4. For warranty service outside of capital city metropolitan area or 30 km from nearest authorised service agent you will be liable for reasonable travelling expenses and the cost of transport of the product or parts to and from the service agent

5. To make a claim under this warranty, you must produce the original invoice or other purchase documentation as proof of the original purchase date. You must send your claim to Shiro Australia Pty Limited, 104 Vanessa Street, Kingsgrove 2208 within 7 days of any alleged defect or failure of the product first becoming apparent, you are responsible for the expense of making a claim under this warranty.

This warranty is given by:

Shiro Australia Pty Ltd

ABN 28 002 386 129

Telephone: 1800 648 556

Facsimile: 1800 628 577

Email: enquiries@robinhood.com.au

www.robinhood.com.au

Attention Customer Services Manager

Warranty exclusions

1. The warranty does not apply where, in Shiro's opinion:

The defect is caused by misuse, wear and tear, dirt, fire or accidental damage.

The product has been repaired or serviced by an unauthorised person.

The product was not installed in accordance with our instructions.

The product was purchased overseas or was not designed for use in Australia.

The product was not used, cleaned or cared for in accordance with our instructions.

The product was used outdoors.

2. All Robinhood Rangehoods are suitable for indoor use only and not suitable over BBQs or charcoal cookers designed for outdoor use.

3. In addition, this warranty does not extend to damage or defects which in our opinion, directly or indirectly arise from or are due to: exposing the product to acidic or corrosive materials or chemicals such as dyes, solvents, denture cleaner or acetone; using inappropriate household cleaning products such as abrasive cream or powder cleansers, furniture polish, bleach, mentholated spirits, drain cleaners, sugar soap, metal pads and strongly alkaline or acidic cleaners; heat damage, including from washing the product at high temperatures; impact or mishandling the product, including the impact caused by objects scraped along, thrown or dropped on the product surface or excessive weight being placed on the product; structural or support changes in or affecting the building or the application where the product has been installed; failure to clean or maintain the product as recommended; or any other causes specified in the product information as being excluded from this warranty.

4. Variations with the colour or gloss within the product or any ageing or fading of colour, shine or gloss level over time are not covered by this warranty. The warranty does not cover visual imperfections or blemishes in the surface and edges of the product that were not brought to your supplier's attention at the time you inspected the product.

5. We will not be responsible under this warranty for, nor pay the costs of, removing the existing product, or reinstalling the new product, or any associated costs or damages.

6. Charcoal filters and light bulbs are not covered by this warranty

The benefits given by this warranty are in addition to other rights and remedies of consumers under any law in relation to the goods which cannot be excluded.

This warranty certificate is not intended to create a contract between Shiro Australia Pty Limited and the purchaser.

Should you require service please contact us on:

Australia

Shiro Australia Pty Ltd

ABN 28 002 386 129

Telephone: 1800 648 556

Facsimile: 1800 628 577

Email: enquiries@robinhood.com.au

www.robinhood.com.au



Warranty Certificate (New Zealand)

Terms and Conditions

The following conditions apply in respect of the warranty given in this certificate:

1. Monaco Corporation Limited ("Monaco") warrants the following Robinhood products against manufacturing defects and faulty materials, under normal use and subject to the exclusions in this certificate, for a period of:
Rangehood, Ovens, Cooktops, Dishwashers - 24 months from date of original purchase for domestic use.
Uniduct – 12 months from date of original purchase for domestic use.
Ironing centre – 12 months from date of original purchase for domestic use.
Taps, including Pull-out and Mixer taps – 5 years on parts only from date of original purchase domestic for use, 24 months parts and labour from date of original purchase for domestic use
Sinks sets– 5 years on stainless steel sink including draining bench from date of original purchase for domestic use, 6 months on all stainless steel accessories, including wire rack, colander and tray from date of original purchase for domestic use.
Laundry Tub - 5 years on stainless bowl, 24 months on Tap, Cabinet and other components from the date of original purchase for domestic use.

"Original purchase", when used in this certificate, means purchase by the customer directly from Monaco or one of its approved suppliers.

2. This warranty is limited to the repair or replacement, at our option, within the warranty period of any component part which we at our discretion determine to contain faulty materials or a manufacturing defect in breach of this warranty. This warranty is subject to terms and conditions set out in this certificate.
3. The warranty only applies within New Zealand.
4. The customer must produce the original invoice or other purchase documentation as proof of the original purchase date.

Warranty exclusions

1. The warranty does not apply where, in Monaco's opinion:
The defect is caused by misuse, wear and tear, dirt, fire or accidental damage.
The product has been repaired or serviced by an unauthorised person.
The product was not installed in accordance with our instructions.
The product was purchased overseas or was not designed for use in New Zealand.
The product was not used, cleaned or cared for in accordance with our instructions.
The product was used outdoors.
2. In addition, this warranty does not extend to damage or defects which in our opinion, directly or indirectly arise from or are due to:
Exposing the product to acidic or corrosive materials or chemicals such as dyes, solvents, denture cleaner or acetone;
Using inappropriate household cleaning products such as abrasive cream or powder cleansers, furniture polish, bleach, mentholated spirits, drain cleaners, sugar soap, metal pads and strongly alkaline or acidic cleaners;
Heat damage, including from washing the product at high temperatures;
Impact or mishandling the product, including the impact caused by objects scraped along, thrown or dropped on the product surface or excessive weight being placed on the product;
Structural or support changes in or affecting the building or the application where the product has been installed;
Failure to clean or maintain the product as recommended; or
any other causes specified in the product information as being excluded from this warranty.
3. Variations with the colour or gloss within the product or any ageing or fading of colour, shine or gloss level over time are not covered by this warranty. The warranty does not cover visual imperfections or blemishes in the surface and edges of the product that were not brought to your supplier's attention at the time you inspected the product.
4. Costs incurred on installation or removal of a product, or any reinstallation of a product, or any associated costs, are not covered by this warranty.
5. Monaco will not be liable for consequential or indirect loss or damage whatsoever and however arising out of or in connection with the supply, performance or removal of the product, including (but not limited to) loss of profit, loss of revenue, loss of contract, loss of goodwill or increased cost of workings, even if due to the negligence of Monaco or any of its approved suppliers, employees or agents.
6. Charcoal filters and light bulbs are not covered by this warranty
7. This warranty and the statements contained in this certificate or other documents given to you do not exclude, restrict or modify the application of any term implied into this warranty by statute, provided that (to the extent any statutory provision permits Monaco to limit its liability for a breach of an implied condition or warranty) Monaco's liability for such breach is limited to the payment of the cost of replacing the product, repairing the product or acquiring an equivalent product.
8. Subject to clause 5, our obligations under this warranty are limited to those set out in this certificate, and this warranty is expressly instead of all other warranties, express or implied, including any implied warranty of merchantability or fitness for a particular purpose and notwithstanding any course of dealing between the parties or custom and usage in trade to the contrary.

Terms and conditions are subject to change.

Should you require service please contact us on:

New Zealand

Monaco Corporation Limited

Telephone: (09) 415 6000

Facsimile: (09) 415 7400

Email: enquiries@robinhood.co.nz

www.robinhood.co.nz

 Robinhood