

Operating instructions Steam oven



To avoid the risk of accidents or damage to the appliance it is **essential** to read these instructions before it is installed and used for the first time.

Contents

Warning and Safety instructions	5
Caring for the environment	14
Guide to the appliance	15
Steam oven front view	15
Accessories supplied	16
Controls	17
Sensor controls	18
Display	18
Description of functions	19
Water container	19
Condensate tray	19
Temperature	19
Cooking duration	19
Noises	19
Heating-up phase	20
Cooking phase	20
Before using for the first time	21
Cleaning for the first time	21
Setting the water hardness level	22
Set the correct boiling point for water	22
Operation	23
Operating the steam oven	23
Interrupting operation	25
Pre-heat	26
General notes	27
The advantages of cooking with steam	27
Suitable containers	27
Condensate tray	27
Shelf level	28
Frozen food	28
Temperature	28
Duration	28
Cooking with liquid	28
Your own recipes	28
Steam cooking	29
Vegetables	29
Meat	32

Sausages.....	34
Fish.....	34
Shellfish.....	37
Mussels.....	38
Rice.....	39
Pasta.....	40
Dumplings.....	41
Grain.....	42
Dried pulses.....	43
Hen's eggs.....	45
Fruit.....	46
Menu cooking (cooking whole meals).....	47
Special applications.....	49
Reheat.....	49
Defrost.....	52
Bottling.....	55
Extracting juice with steam.....	57
Make yoghurt.....	58
Prove dough.....	59
Dissolve gelatine.....	59
Melt chocolate.....	60
Skinning vegetables and fruit.....	60
Apple storage.....	61
Blanching.....	61
Sweat onions.....	62
Cook bacon.....	62
Disinfect items.....	63
Heating damp flannels.....	63
Decrystallise honey.....	63
Making eierstich.....	64
Settings.....	65
Note for test institutes.....	67
Cleaning and care.....	68
Cleaning the steam oven front and casing.....	69
Cleaning the oven compartment.....	70
Accessories.....	70
Cleaning the side runners.....	71
Emptying and drying the water container.....	72
Descaling the water container.....	74

Contents

Problem solving guide	76
Optional accessories	79
Cooking containers	79
Cleaning and care products	81
Miscellaneous.....	81
Technical data	82
After sales service	83
Contact in case of malfunction	83
Data plate	83
Warranty	83

Warning and Safety instructions

This steam oven conforms to current safety requirements. Inappropriate use can, however, lead to personal injury and damage to property.

To avoid the risk of personal injury and damage to the steam oven, please read these instructions carefully before using it for the first time. They contain important notes on installation, safety, use and maintenance.

Miele cannot be held liable for damage caused by non-compliance with these instructions.

Keep these instructions in a safe place and ensure that new users are familiar with the contents. Pass them on to any future owner.

Warning and Safety instructions

Correct application

- ▶ This steam oven is intended for use in domestic households and similar working and residential environments.
- ▶ This steam oven is not intended for outdoor use.
- ▶ This steam oven is intended for domestic use only as described in these operating instructions.
Any other usage is not supported by the manufacturer and could be dangerous.
- ▶ The steam oven can only be used by people with reduced physical, sensory or mental capabilities, or lack of experience and knowledge, if they are supervised whilst using it, or have been shown how to use it in a safe way and recognise and understand the consequences of incorrect operation.

Safety with children

- ▶ Children under 8 years of age must be kept away from the steam oven unless they are constantly supervised.
- ▶ Children aged 8 and older may only use the steam oven without supervision if they have been shown how to use it in a safe manner. Children must be able to understand and recognise the possible dangers caused by incorrect operation.
- ▶ Children must not be allowed to clean the steam oven unsupervised.
- ▶ Please supervise children in the vicinity of the steam oven and do not let them play with it.
- ▶ Danger of suffocation! Whilst playing, children may become entangled in packaging material (such as plastic wrapping) or pull it over their head with the risk of suffocation. Keep packaging material away from children.
- ▶ Danger of burning from steam. Children's skin is far more sensitive to high temperatures than that of adults. Children must not be allowed to open the steam oven door if it is in use. Keep children well away from the steam oven until it has cooled down and there is no danger of burning.
- ▶ Danger of injury. The oven door can support a maximum weight of 8 kg. Children could injure themselves on an open door. Do not let children swing on the door when it is open.

Warning and Safety instructions

Technical safety

- ▶ Unauthorised installation, maintenance and repairs can cause considerable danger for the user. Installation, maintenance and repairs must only be carried out by a Miele authorised technician.
- ▶ Never use a damaged steam oven. It could be dangerous. Check it for visible signs of damage before using it.
- ▶ Reliable and safe operation of this steam oven can only be assured if it has been connected to the mains electricity supply.
- ▶ The electrical safety of this appliance can only be guaranteed when correctly earthed. It is essential that this standard safety requirement is met. If in any doubt please have the electrical installation tested by a qualified electrician.
- ▶ Before connecting the appliance to the mains supply, ensure that the connection data on the data plate (voltage and frequency) match the mains electricity supply.
This data must correspond in order to avoid the risk of damage to the appliance. Consult a qualified electrician if in any doubt.
- ▶ Do not connect the steam oven to the mains electricity supply by a multi-socket adapter or an extension lead. These do not guarantee the required safety of the appliance (fire hazard).
- ▶ This steam oven must not be used in a non-stationary location (e.g. on a ship).
- ▶ Never open the casing of the appliance. Tampering with electrical connections or components and mechanical parts is highly dangerous to the user and can cause operational faults.
- ▶ While the appliance is under guarantee, repairs should only be undertaken by a Miele authorised service technician. Otherwise the guarantee is invalidated.

Warning and Safety instructions

- ▶ Miele can only guarantee the safety of the appliance when genuine original Miele replacement parts are used. Faulty components must only be replaced by Miele spare parts.
- ▶ If the plug is removed from the connection cable or if the cable is supplied without a plug, the appliance must be connected to the electrical supply by a suitably qualified electrician.
- ▶ If the connection cable is damaged, it must be replaced with a special connection cable type H 05 VV-F (PVC insulated), available from Miele.
- ▶ During installation, maintenance and repair work, the appliance must be disconnected from the mains electricity supply.
- ▶ If the steam oven is installed behind a furniture panel (e.g. a door), ensure that the door is never closed whilst the steam oven is in use. Heat and moisture can build up behind a closed furniture panel and cause subsequent damage to the steam oven, the housing unit and the floor. Do not close the door until the steam oven has cooled down completely.
- ▶ In areas which may be subject to infestation by cockroaches or other vermin, pay particular attention to keeping the appliance and its surroundings clean at all times. Any damage caused by cockroaches or other vermin will not be covered by the warranty.

Warning and Safety instructions

Correct use

▶ Danger of burning. The steam oven gets hot during operation. You could burn yourself on the oven compartment, accessories, food or steam.

Use oven gloves when placing food in the oven or removing it and when working in a hot oven.

When putting cooking containers into the oven or taking them out, take care not to spill the contents.

▶ Do not use the steam oven to heat up or bottle food in sealed jars and tins.

Pressure will build up inside them and they can explode causing damage to the appliance, as well as the risk of injury and scalding.

▶ Plastic dishes which are not heat- and steam resistant melt at high temperatures and can damage the appliance.

Use temperature- (to 100°C) and steam-resistant plastic dishes. Follow the manufacturer's instructions.

▶ Food which is stored in the oven compartment can dry out and the moisture released can lead to corrosion damage in the steam oven. Do not leave food in the oven compartment and do not use any cooking containers which are susceptible to corrosion.

▶ You could injure yourself on the open oven door.

Avoid leaving the door open unnecessarily.

▶ When using a small electrical appliance, e.g. a hand-held blender, near the steam oven, care should be taken that the cable of the appliance cannot get trapped by the steam oven door. The insulation on the cable could become damaged, giving rise to an electric shock hazard.

▶ The steam oven is designed in such a way that there will always be a little residual water left in the water container after use. If there is no residual water, there is something wrong. Call the Service Department.

Warning and Safety instructions

- ▶ Do not immerse the water container in water, or clean it in a dishwasher. Connecting the water container into the appliance when wet could cause an electric shock.
- ▶ For reasons of hygiene and to prevent the build-up of moisture in the appliance, the water container should be emptied after each use.
- ▶ Danger of burning. There may be some residual hot water in the water container at the end of a cooking process. Take care not to spill the contents when taking the water container out of the appliance.
- ▶ To avoid the risk of scratches, do not place items on top of the appliance.

Warning and Safety instructions

Cleaning and care

- ▶ Do not use a steam cleaning appliance to clean this appliance. The steam could reach electrical components and cause a short circuit.
- ▶ Scratches on the door glass can result in the glass breaking. Do not use abrasive cleaners, hard sponges, brushes or sharp metal tools to clean the door glass.
- ▶ The side runners can be removed (see “Cleaning and care” – “Cleaning the side runners”). Refit the side runners correctly.
- ▶ Try to avoid the interior walls being splashed with food or liquids containing salt. If it does happen, wipe these away thoroughly to avoid corrosion to stainless steel surfaces inside the cabinet.

Accessories

- ▶ Only use genuine original Miele accessories and spare parts with this appliance. Using accessories or spare parts from other manufacturers will invalidate the warranty and Miele cannot accept liability.

Location advice

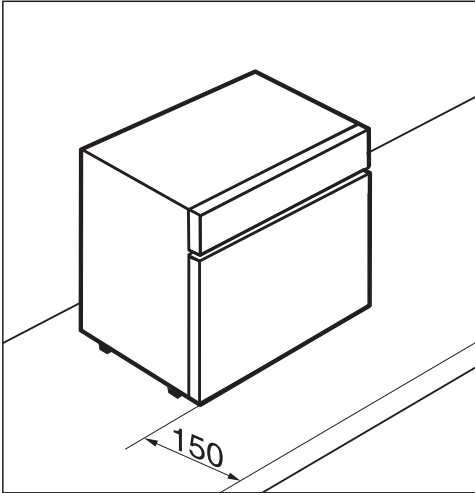

- ▶ The safety distance of 150 mm between the appliance door when closed and the front edge of the worktop/table top must be at least 150 mm.

Caring for the environment

Disposal of the packing material

The packaging is designed to protect the appliance from damage during transportation. The packaging materials used are selected from materials which are environmentally friendly for disposal and should be recycled.

Recycling the packaging reduces the use of raw materials in the manufacturing process and also reduces the amount of waste in landfill sites.

Disposing of your old appliance

Electrical and electronic appliances often contain valuable materials. They also contain specific materials, compounds and components, which were essential for their correct function and safety. These could be hazardous to human health and to the environment if disposed of with your domestic waste or if handled incorrectly. Please do not, therefore, dispose of your old appliance with your household waste.



Please dispose of it at your local community waste collection / recycling centre for electrical and electronic appliances, or contact your dealer or Miele for advice. You are also responsible (by law, depending on country) for deleting any personal data that may be stored on the appliance being disposed of. Please ensure that your old appliance poses no risk to children while being stored prior to disposal.

Steam oven front view

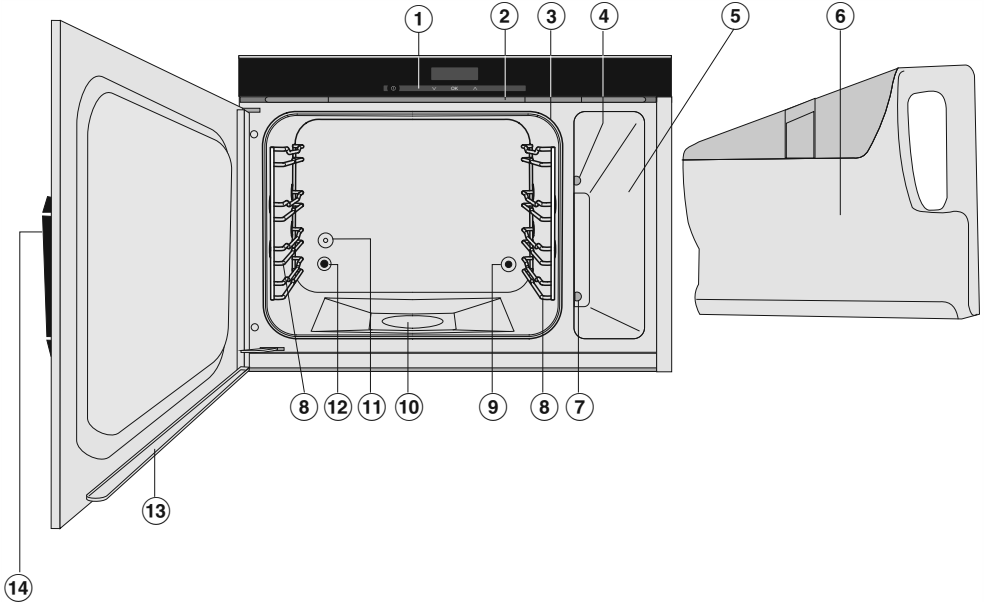

- | | |
|------------------------------------|------------------------------------|
| ① Control elements | ⑧ Side runners with 4 shelf levels |
| ② Ventilation outlet | ⑨ Steam inlet |
| ③ Door seal | ⑩ Floor heater element |
| ④ Steam channel | ⑪ Temperature sensor |
| ⑤ Compartment for water container | ⑫ Steam outlet |
| ⑥ Water container with insert | ⑬ Drip channel in the door |
| ⑦ Water container connection point | ⑭ Door release |

Guide to the appliance

Accessories supplied

The accessories supplied with your appliance as well as a range of optional ones are available to order from Miele (see “Optional accessories”).

DGG 15



1 condensate tray for collecting excess moisture, can also be used as a cooking container.

325 x 265 x 40 mm (W x D x H)

DGGL 1

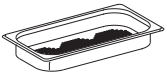

2 perforated cooking containers

Gross capacity 1.5 l

Usable capacity 0.9 l

325 x 175 x 40 mm (W x D x H)

Silicone grease



1 tube for lubricating the coupling seal on the water container

Descaling tablets

For descaling the appliance

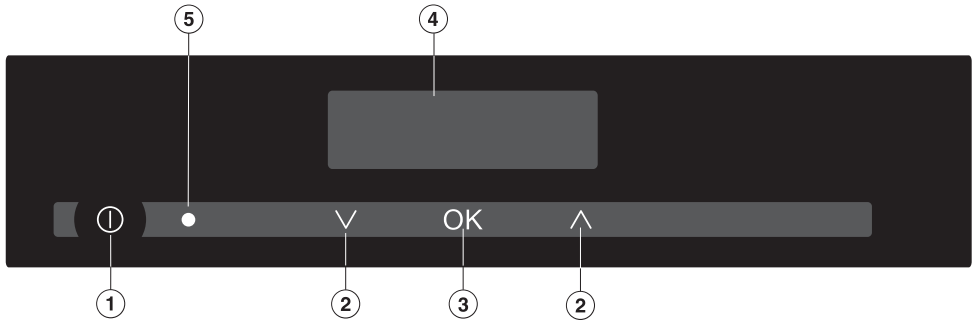

- ① Recessed On/Off button ①
For switching the appliance on and off and accessing the descaling process
- ② ∇/∧ sensors
For setting the temperature and cooking duration and for “scrolling” through options.
Settings are accessed using: ① + ∇ (see “Settings”)
- ③ OK sensor
For confirming input
- ④ Display
- ⑤ Optical interface
(for Miele service technician use only)

Controls

Sensor controls

The sensors react to touch. Each touch is confirmed with a keypad tone. This keypad tone can be switched off (see “Settings”).

Display

Display	Meaning
☹ (flashing)	Insufficient water or water container not present
Numbers + °C	Temperature
Numbers + h	Duration
☹ + number(s)	The appliance needs to be descaled.

Water container

The maximum filling volume is 1.2 l and the minimum is 0.75 l. There are markings on the inside and outside of the water container. The upper marking must never be exceeded.

The water consumption depends on the type of food and the duration of cooking. The water may need to be topped up during cooking. The water consumption is increased if the door is opened during cooking.

If the  symbol is flashing, either the water container is not pushed in correctly or there is not enough water in it.

Condensate tray

When using perforated containers, place the condensate tray on the lowest shelf level to collect any drops of liquid and allow them to be removed easily.

You can also use the condensate tray as a cooking container if necessary.

Temperature

The steam oven has a temperature range of 40 °C to 100°C. The appliance is set at 100 °C when the oven is switched on. You can alter the temperature in 5 °C steps.

Recommended temperature

Temperature	When to use
100 °C	<ul style="list-style-type: none">– Cooking all types of food– Reheating– Menu cooking (cooking whole meals)– Bottling– Extracting juice
85 °C	<ul style="list-style-type: none">– Cooking fish gently
60 °C	<ul style="list-style-type: none">– Defrosting
40 °C	<ul style="list-style-type: none">– Proving dough– Making yoghurt

Cooking duration

You can set a cooking duration of between 1 minute (0:01) and 9 hours 59 minutes (9:59). If the duration exceeds 59 minutes you have to enter it in hours and minutes.

Example: Duration 80 minutes = 1:20.

Noises

You can hear the noise of the fan when the appliance is operating. Noises similar to those of a kettle can be heard when steam is being generated.

Description of functions

Heating-up phase

During the heating-up phase the oven compartment is heated to the set temperature. The display will show the temperature in the cooking compartment as it rises.

The duration of the heating-up phase will depend on the quantity and the temperature of the food. In general the heating-up phase will last for approx. 7 minutes. The duration will be longer if you are cooking refrigerated or frozen food.

Filling the water container with hot water will shorten the heating-up time.

Cooking phase

The cooking phase begins when the set temperature is reached. During the cooking phase, the duration remaining will be shown in the display.

Before using for the first time

- Please stick the extra data plate for the appliance supplied with this documentation in the space provided in the “After sales service” section of this booklet.
- Remove any protective wrapping and stickers.

The appliance has undergone a function test in the factory. Residual water from this testing may have trickled back into the cabinet during transportation.

Cleaning for the first time

Opening the door

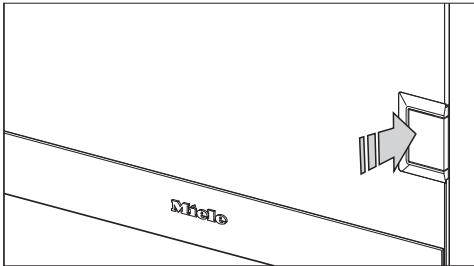

- Open the door by pressing on the left hand side of the door release.

The door will open slightly.

Cleaning the water container

⚠ Risk of damage due to ingress of water.

The water container's heating element can become damaged if it is exposed to water.

Do not clean the water container or the insert in the dishwasher and do not immerse the water container in water.

- Take the water container out of the steam oven and remove the insert (see “Cleaning and care” – “Water container”).
- Rinse the water container and the insert thoroughly by hand using hot water. Do not use any washing-up liquid or detergent.

Cleaning accessories/oven compartment

- Take all accessories out of the oven.
- Wash the accessories in a mild solution of washing-up liquid and hot water or in the dishwasher.

The interior of the steam oven has been treated at the factory with a conditioning agent.

- To remove this, clean the oven compartment with a clean sponge and a mild solution of washing-up liquid and hot water.

Before using for the first time

Setting the water hardness level

The steam oven is set to a **hard** water hardness level at the factory. It must be adjusted to the local water hardness level to ensure that it works correctly and to ensure that descaling is carried out at the correct interval. The harder the water is, the more frequently the steam oven needs to be descaled.

- Check the hardness of your local water supply and adjust the setting if necessary (see “Settings”).

Set the correct boiling point for water

Before cooking food for the first time, you must adjust the boiling temperature of the water, which varies depending on the altitude of where the steam oven is located. This procedure also flushes out the waterways.

This procedure **must** be carried out to ensure efficient functioning of your appliance.

- Run the steam oven for 15 minutes at 100 °C. Proceed as described in “Operation”.

Setting the correct boiling point for water following a house move

If you move house, the appliance will need to be re-set for the new altitude if this differs from the old one by 300 m or more. To do this, descale the appliance (see “Cleaning and care” – “Descaling”).

Operating the steam oven

Only use drinking water. Never use distilled or mineral water or other liquids.

- Fill the water container and push it into the appliance until it connects.

If the water container is not inserted correctly, the steam oven will not heat up and after a short time *F20* will appear in the display (see “Problem solving guide”).

- Place the condensate tray on the lowest shelf level when using perforated containers.
- Place the food in the oven.
- Close the door.
- Switch the steam oven on using the On/Off  button.



100 will appear in the display and °C will start flashing.

- If you want to cook with 100 °C, confirm the setting with OK.
- If you wish you can set a lower temperature by touching the ∨ sensor control. Confirm with OK.



0:00 will appear in the display and *h* will start flashing.

- Set the cooking duration you want by touching the ^ sensor control (from 0:00 upwards) or ∨ (from 9:59 downwards).
- Confirm with OK.

The cooking process begins. The steam generator and fan switch on.

If you do not complete these steps within 15 minutes, the appliance will switch itself off.

Operation

Taking food out of the oven

At the end of the cooking duration, a signal sounds and 0:00 h appears in the display.

 Risk of injury caused by hot surfaces and steam.

Steam will escape when the door is opened. The oven compartment walls, food and accessories get very hot during cooking.

Open the door carefully, then step back and wait until the steam has dissipated.

Use oven gloves when taking food out of the oven and when working in the hot oven compartment.

- Open the door and remove the food.
- Switch the steam oven off using the On/Off  button.

If you want to reduce the fan run-on time, you can do so by removing the water container as soon as you have switched the appliance off.

Cleaning the steam oven

- Remove the condensate tray and empty it.
- Remove and empty the water container. Remove the water container by pushing it upwards slightly.

The appliance is designed in such a way that there will always be a little residual water left in the water container after use. If there is no residual water, there is something wrong. Call Miele Service.

- After each use, clean and dry the whole appliance as described in “Cleaning and care”.
- Leave the appliance door open until the oven compartment is completely dry.

Refilling the water

Insufficient water is indicated by the flashing  symbol and an audible tone.

- Remove the water container and fill it with fresh tap water.
- Push the water container into the appliance until it connects.
- Close the door.

Operation will continue.

Changing settings during a programme

You can alter the temperature and cooking duration at any time during operation.

Changing the temperature

- Touch OK briefly once.

The display will change to the temperature setting and °C will flash.

- Set the temperature as described earlier.

Changing the cooking duration

- Touch OK briefly twice.

The display will change to the cooking duration setting and h will flash.

- Set the cooking duration as described earlier.

Interrupting operation

Operation is interrupted as soon as the door is opened. The heating will be switched off and the cooking duration will remain stored in the memory.

 Risk of injury caused by hot surfaces and steam.

Steam will escape when the door is opened. The oven compartment walls, food and accessories get very hot during cooking.

Open the door carefully, then step back and wait until the steam has dissipated.

Use oven gloves when taking food out of the oven and when working in the hot oven compartment.

Operation will resume when the door is closed.

When the door is closed, the pressure has to equalise, which can cause a whistling sound.

The steam oven will heat up again and the display will show the temperature in the oven compartment as it rises. Once the set temperature has been reached, the display will change to show the cooking duration remaining as it counts down.

The cooking programme will finish early if the door is opened in the last minute of cooking.

Operation

Pre-heat

Your appliance has a pre-heating function. This heats the oven interior to approx. 40 °C. The heating-up time is then shorter as the oven interior is pre-heated and therefore the cooking process takes less time.

The appliance is delivered with this function deactivated. If you wish to use it you will need to alter the setting (see “Settings”).

When the pre-heating function has been activated you can still choose whether you want to use it for each programme.

The water container must be filled with water for pre-heating and present in the appliance.

The pre-heating process will be cancelled if the door is opened. You can start the process again by switching the appliance off and then back on again.

Using pre-heat

- Switch the steam oven on.

100 will appear in the display and °C will start flashing. **Do not** confirm.

After a few seconds the pre-heating process will begin and the display will show the temperature as it rises.

When pre-heating is finished, 100 will appear in the display and °C will flash.

- Place the food in the oven.
- Set the temperature and duration as normal.

Not using pre-heat

- Place the food in the oven.
- Switch the steam oven on.

100 will appear in the display and °C will start flashing.

- Confirm this with OK or set the required temperature as normal.
- Set the cooking duration as described earlier.

This section contains general information. You will find more detailed information about particular foods and how to cook them in the other sections.

The advantages of cooking with steam

Almost all vitamins and minerals are retained as the food is not immersed in water.

Cooking with steam also retains the true taste of the food better than conventional cooking. We therefore recommend seasoning the food after it has been cooked. Food also retains its fresh, original colour.

Suitable containers

Cooking containers

This steam oven is supplied with stainless steel cooking containers. Other containers, in a variety of sizes, both perforated and solid, are available as optional extras (see “Optional accessories”). This enables you to choose the most suitable container for the food you are cooking.

It is best to use perforated containers for steam cooking. The steam can reach the food from all sides and the food is cooked evenly.

Your own containers

You can also use your own containers. However, please note the following:

- Containers must be heat-resistant to 100 °C and able to withstand hot steam. With plastic containers please check with the manufacturer that they are suitable for use in a steam oven.
- Thick-sided containers made from porcelain, china or stoneware, for example, are not so suitable for steam cooking. They do not conduct heat well and as a result cooking durations will be considerably longer than those given in the charts.
- Place the cooking container in a sufficiently large perforated container, not on the oven floor.
- Ensure that there is a gap between the upper rim of the container and the top of the cooking compartment to allow sufficient steam into the container.

Condensate tray

When using perforated containers, place the condensate tray on the lowest shelf level to collect any drops of liquid and allow them to be removed easily.

You can also use the condensate tray as a cooking container if necessary.

General notes

Shelf level

You can select any shelf level. You can also cook on several levels at the same time. This will not alter the cooking duration.

Always insert cooking containers and the rack between the rails of the side runners so that they cannot tip.

Frozen food

The heating up phase for frozen food is longer than for fresh food. The greater the quantity of frozen food, the longer the heating up phase.

Temperature

A maximum temperature of 100 °C is reached when steam cooking is taking place. Most types of food will cook at this temperature. Some more delicate types of food, such as soft fruit, must be cooked at lower temperatures as otherwise they will burst. More information is given in the relevant section.

Combination with a food warming drawer

When the warming drawer is in use the oven cavity in the steam oven can get up to 40 °C. If, in this case, you set a temperature of 40 °C, no steam will be produced because the oven cavity is too warm.

Duration

In general, the cooking durations for cooking with steam are the same as for cooking food in a saucepan. More information about any factors which may affect the cooking duration is given in the relevant sections.

The quantity of food does not affect the cooking duration. 1 kg of potatoes will take the same time to cook as 500 g.

The durations given in the charts are guidelines only. We recommend selecting the shorter cooking duration quoted to start with. If food is not cooked sufficiently after the shorter time it can be put back in the oven and cooked for longer.

Cooking with liquid

When cooking with liquid only fill the cooking container $\frac{2}{3}$ full to prevent the liquid spilling when the cooking container is removed from the oven.

Your own recipes

Food which is cooked in a pot or a pan can also be cooked in the steam oven. The cooking durations in the steam oven will be the same. Please note that food will not be brown or crisp when cooking with steam.

Vegetables

Fresh

Prepare fresh vegetables in the usual way, i.e. wash, clean and cut them up.

Frozen food

Frozen vegetables do not need to be defrosted beforehand, unless they have been frozen together in a block.

Frozen and fresh vegetables which take the same length of time to cook can be cooked together.

If vegetables have frozen together in clumps, break these up before cooking with steam. Follow the manufacturer's instructions on the packaging regarding cooking duration.

Cooking containers

Food such as peas or asparagus spears, which have little or no space between them, will take longer to cook because the steam has less space to work in. For an even result, it is best to use a shallow container for these types of food, and only fill it about 3-5 cm deep. When cooking large quantities divide the food between 2 or 3 shallow containers rather than using one deep one.

Different types of vegetables which take the same length of time to cook can be cooked together.

Use solid containers for vegetables which are cooked in liquid.

Shelf level

To avoid any colour transfer when cooking vegetables with a distinctive colour (e.g. beetroot) in a perforated container, do not place other food underneath the perforated container.

Duration

As with conventional methods, the cooking duration when cooking vegetables with steam will depend on the size and how well done you want them.

Example:

firm potatoes, cut into quarters

= approx. 17 minutes

firm potatoes, cut in half

= approx. 21 minutes

Settings

Temperature: 100 °C

Duration: see chart

Steam cooking

The durations given in the chart are guidelines for fresh vegetables. We recommend selecting the shorter cooking duration quoted. If food is not cooked sufficiently after the shorter duration it can be put back in the oven and cooked for longer.

Vegetables	🕒 [min]
Artichokes	32–38
Cauliflower, whole	27–28
Cauliflower, florets	8
Beans, green	10–12
Broccoli, florets	3–4
Chantenay carrots, whole	7–8
Chantenay carrots, halved	6–7
Chantenay carrots, chopped	4
Chicory, halved	4–5
Chinese cabbage, chopped	3
Peas	3
Fennel, halved	10–12
Fennel, cut into strips	4–5
Curly kale, chopped	23–26
Firm potatoes, peeled whole	27–29
halved	21–22
quartered	16–18
Fairly firm potatoes, peeled whole	25–27
halved	19–21
quartered	17–18
Floury potatoes, peeled whole	26–28
halved	19–20
quartered	15–16
Kohlrabi, cut into batons	6–7

Steam cooking

Vegetables	 [min]
Pumpkin, diced	2–4
Corn on the cob	30–35
Chard, chopped	2–3
Peppers, diced / cut into strips	2
New potatoes, firm	30–32
Mushrooms	2
Leeks, sliced	4–5
Leeks, halved lengthwise	6
Romanesco, whole	22–25
Romanesco, florets	5–7
Brussels sprouts	10–12
Beetroot, whole	53–57
Red cabbage, chopped	23–26
Black salsify, whole	9–10
Celeriac, cut into batons	6–7
Green asparagus	7
White asparagus	9–10
Main crop carrots, chopped	6
Spinach	1–2
Spring cabbage, chopped	10–11
Celery, chopped	4–5
Swede, chopped	6–7
White cabbage, chopped	12
Savoy cabbage, chopped	10–11
Courgettes, sliced	2–3
Sugar snap peas	5–7

 Duration

Steam cooking

Meat

Fresh

Prepare the meat in the usual way.

Frozen food

Meat should be thoroughly defrosted before cooking in the steam oven (see “Special applications” – “Defrost”).

Preparation

For meat which needs to be seared before being cooked, e.g. for a stew, sear the meat in a pan on the hob first.

Duration

The cooking duration depends on the thickness and the texture of the meat, and not on the weight. The thicker the piece of meat, the longer the cooking duration. A piece of meat weighing 500 g which is 10 cm thick will take longer to cook than a piece of meat weighing 500 g which is 5 cm thick.

Tips

- Use a perforated container to retain the **juices** when cooking meat. Place a solid container underneath to catch the juices. You can use these to make a gravy or freeze them for later use.
- Boiling fowl, back or top rib and meat bones can be used to make **stock**. Place the meat together with some mixed vegetables in a solid cooking container and add cold water and cook. The longer the cooking duration, the stronger the stock.

Settings

Temperature: 100 °C

Duration: see chart

Steam cooking

The durations given in the charts are guidelines only. We recommend selecting the shorter cooking duration quoted to start with. If food is not cooked sufficiently after the shorter time it can be put back in the oven and cooked for longer.

Meat	🕒 [min]
Leg steak, covered with water	110–120
Knuckle	135–140
Chicken breast	8–10
Shank	105–115
Top rib, covered with water	110–120
Veal cutlets	3–4
Gammon slices	6–8
Lamb stew	12–16
Poularde	60–70
Turkey roulade	12–15
Turkey escalope	4–6
Brisket, covered with water	130–140
Beef stew	105–115
Boiling fowl, covered with water	80–90
Boiled topside	110–120

🕒 Duration

Steam cooking

Sausages

Settings

Temperature: 90 °C

Duration: see chart

Sausages	⌚ [min]
Frankfurters	6–8
Bologna sausages	6–8
Veal sausages	6–8

⌚ Duration

Fish

Fresh

Prepare fresh fish in the usual way, i.e. clean, gut and fillet.

Frozen food

Fish does not need to be fully defrosted before cooking. Defrost so that the surface is sufficiently thawed to take herbs and seasoning. Depending on the thickness of the fish, 2 - 5 minutes should be enough.

Preparation

Add some lemon or lime juice to fish before cooking. The citric acid helps the flesh stay firm.

It is not necessary to season fish with salt when cooking with steam as this method retains the minerals which give the fish its unique flavour.

Cooking containers

If using a perforated container, grease it first.

Shelf level

When cooking fish in a perforated container at the same time as cooking other types of food in other containers, place the container with the fish directly above the condensate tray/universal tray (depending on model) to catch any liquid and so avoid any transfer of tastes to other food.

Temperature

85 °C – 90 °C

For gently cooking delicate types of fish, such as sole.

100 °C

For cooking firmer types of fish, e.g. cod and salmon.

Also for cooking fish in sauce or stock.

Duration

The cooking duration depends on the thickness and the texture of the fish, and not on the weight. The thicker the fish, the longer the cooking duration. A 3 cm thick piece of fish weighing 500 g will take longer to cook than a 2 cm thick piece of fish weighing 500 g.

The longer fish cooks, the firmer its flesh will become. Use the cooking durations given in the chart. If you find that the fish is not cooked sufficiently only cook it for a few minutes more.

When cooking fish in sauce or stock, we recommend that you increase the cooking duration quoted by a few minutes.

Tips

- Adding herbs and spices, such as dill, will help bring out the full flavour of the fish.
- Cook large fish in the swimming position. To help maintain the shape of the fish, place a small cup or similar upside down in the cooking container, and arrange the fish bellysides down over the cup.
- You can use any fish scraps, e.g. fish heads, bones, tails etc to make a **fish stock**. Place the fish scraps together with some mixed vegetables in a solid cooking container and add cold water. Cook at 100 °C for 60 to 90 minutes. The longer the cooking duration, the stronger the stock.
- **Blue fish** is fish which is cooked in water and vinegar. It is important not to damage the skin of the fish. This method is suitable for cooking carp, trout, tench, eel and salmon. (Follow recipe instructions for the ratio of water to vinegar).

Settings

Temperature: see chart

Duration: see chart

Steam cooking

The cooking durations given in the chart are guidelines for fresh fish. We recommend selecting the shorter cooking duration quoted. If food is not cooked sufficiently after the shorter duration it can be put back in the oven and cooked for longer.

Fish	🌡️ [°C]	🕒 [min]
Eel	100	5–7
Perch fillet	100	8–10
Seabream fillet	85	3
Trout, 250 g	90	10–13
Halibut fillet	85	4–6
Cod fillet	100	6
Carp, 1.5 kg	100	18–25
Salmon fillet	100	6–8
Salmon steak	100	8–10
Salmon trout	90	14–17
Basa fillet	85	3
Rosefish fillet	100	6–8
Haddock fillet	100	4–6
Plaice fillet	85	4–5
Monkfish fillet	85	8–10
Sole fillet	85	3
Turbot fillet	85	5–8
Tuna fillet	85	5–10
Pike perch fillet	85	4

🌡️ Temperature 🕒 Duration

Shellfish

Preparation

Defrost frozen shellfish before cooking with steam.

Peel, remove and discard the intestines, and then wash the shellfish.

Cooking containers

If using a perforated container, grease it first.

Duration



The longer shellfish are cooked, the tougher they become. Use the cooking durations given in the chart.

When cooking shellfish in sauce or stock, we recommend that you increase the cooking duration quoted by a few minutes.

Settings

Temperature: see chart

Duration: see chart

	 [°C]	 [min]
Crevettes	90	3
Prawns	90	3
King prawns	90	4
Small shrimps	90	3
Lobster	95	10–15
Large shrimps	90	3

 Temperature  Duration

Steam cooking

Mussels

Fresh food

 Danger of food poisoning from spoiled mussels.
Spoiled mussels can cause food poisoning.
Only cook mussels which are closed.
Do not eat mussels which have not opened after being cooked.

Steep fresh mussels in water for a few hours before cooking to rinse out any sand. Then scrub the mussels thoroughly to clean them.

Frozen food

Defrost frozen mussels before cooking.



Duration

The longer mussels are cooked, the tougher they become. Use the cooking durations given in the chart.

Settings

Temperature: see chart

Duration: see chart

	 [°C]	 [min]
Barnacles	100	2
Cockles	100	2
Mussels	90	12
Scallops	90	5
Razor clams	100	2–4
Venus clams	90	4

 Temperature  Duration

Rice

Rice swells when cooked and needs to be cooked in liquid. The proportion of rice to liquid will vary depending on the type of rice.

The rice absorbs all the liquid during the cooking process and so none of the nutrients are lost.

Settings

Temperature: 100 °C

Duration: see chart

	Ratio Rice : Liquid	🕒 [min]
Basmati rice	1 : 1.5	15
Parboiled rice	1 : 1.5	23–25
Round grain rice		
Pudding rice	1 : 2.5	30
Risotto rice	1 : 2.5	18–19
Brown rice	1 : 1.5	26–29
Wild rice	1 : 1.5	26–29

🕒 Duration

Steam cooking

Pasta

Dry pasta

Dry pasta swells when it is cooked and needs to be cooked in liquid. The liquid must cover the pasta. Using hot liquid gives better results.

Increase the cooking time stated by the manufacturer by approx. $\frac{1}{3}$.

Fresh food

Fresh pasta, such as the kind you can buy from the supermarket chilled counter, does not need to absorb water. Cook fresh pasta in a greased perforated container.

Separate any pieces of pasta which have stuck together and spread them out in the cooking container.

Settings

Temperature: 100 °C

Duration: see chart

Fresh	 [min]
Gnocchi	2
Knöpfli	1
Ravioli	2
Spätzle	1
Tortellini	2
Dry pasta, covered with water	
Tagliatelli	14
Vermicelli	8

 Duration

Dumplings

Ready made boil-in-the-bag dumplings need to be well covered with water as otherwise they can fall apart. This is because even though they have been soaked in water beforehand they will not absorb enough moisture.

Cook fresh dumplings in a greased, perforated container.

Settings

Temperature: 100 °C

Duration: see chart

	🕒 [min]
Sweet dumplings	30
Yeast dumplings	20
Boil-in-the-bag potato dumplings	20
Boil-in-the-bag bread dumplings	18–20

🕒 Duration

Steam cooking

Grain

Grain swells during cooking and needs to be cooked in liquid. The proportion of grain to liquid depends on the type of grain.

Grain can be cooked whole or cracked.

Settings

Temperature: 100 °C

Duration: see chart

	Ratio Grain : Liquid	🕒 [min]
Amaranth	1 : 1.5	15–17
Bulgur	1 : 1.5	9
Green spelt, whole	1 : 1	18–20
Green spelt, cracked	1 : 1	7
Oats, whole	1 : 1	18
Oats, cracked	1 : 1	7
Millet	1 : 1.5	10
Polenta	1 : 3	10
Quinoa	1 : 1.5	15
Rye, whole	1 : 1	35
Rye, cracked	1 : 1	10
Wheat, whole	1 : 1	30
Wheat, cracked	1 : 1	8

🕒 Duration

Dried pulses

Soak pulses for at least 10 hours in cold water before cooking. Soaking makes the pulses more digestible and shortens the cooking duration required. Soaked pulses must be covered with liquid during cooking.

Lentils do not need to be soaked before cooking.

With unsoaked pulses a certain ratio of pulses to liquid is required depending on variety.

Settings

Temperature: 100 °C

Duration: see chart

Soaked	
	🕒 [min]
Beans	
Kidney beans	55–65
Adzuki beans	20–25
Black beans	55–60
Pinto beans	55–65
Haricot beans	34–36
Peas	
Yellow split peas	40–50
Green split peas	27

🕒 Duration

Steam cooking

Unsoaked		
	Ratio Pulses : Liquid	🕒 [min]
Beans		
Kidney beans	1 : 3	130–140
Adzuki beans	1 : 3	95–105
Black beans	1 : 3	100–120
Pinto beans	1 : 3	115–135
Haricot beans	1 : 3	80–90
Lentils		
Brown lentils	1 : 2	13–14
Red lentils	1 : 2	7
Peas		
Yellow split peas	1 : 3	110–130
Green split peas	1 : 3	60–70

🕒 Duration

Hen's eggs

Use a perforated container to boil eggs in the steam oven.

The eggs do not need to be pierced before cooking as they are gradually warmed during the heating up phase and so do not burst when they are cooked with steam.

When using a solid container for making egg dishes such as scrambled eggs, remember to grease it first.

Settings

Temperature: 100 °C

Duration: see chart

	 [min]
Small soft medium hard	 3 5 9
Medium soft medium hard	 4 6 10
Large soft medium hard	 5 6–7 12
Extra large soft medium hard	 6 8 13

 Duration

Steam cooking

Fruit

Cook fruit in a solid container so that none of the juice is lost. If you wish to cook fruit in a perforated container, place a solid container directly underneath it to collect the juice.

Tip: You can use the juice which has collected in the solid container to make a glaze for a fruit flan.

Settings

Temperature: 100 °C

Duration: see chart

	 [min]
Apple pieces	1–3
Pear chunks	1–3
Cherries	2–4
Mirabelle plums	1–2
Nectarine / Peach pieces	1–2
Plums	1–3
Quince, diced	6–8
Rhubarb pieces	1–2
Gooseberries	2–3

 Duration

Menu cooking (cooking whole meals)

You can use the steam oven to cook a whole meal containing types of food which have different cooking durations, e.g. fish fillet with rice and broccoli. Each dish is placed in the oven at different times so that they are all ready at the same time.

Shelf level

When cooking fish or food with a distinctive colour (e.g. beetroot) in a perforated container, place the perforated container directly above the condensate tray / universal tray (depending on model) to avoid any transfer of flavour or colour to other food and to prevent liquid dripping onto food below it.

Temperature

Whole meals should be cooked at a temperature of 100 °C as this is the temperature required to cook the majority of foods.

Do not cook a whole meal at the lowest temperature when different temperatures are required for different types of food, e.g. 85 °C for seabream and 100 °C for potatoes.

If the recommended cooking temperature for the food is 85 °C for example, try cooking it at 100 °C and testing the result. Some delicate types of fish with a soft structure, e.g. sole and plaice will become very firm when cooked at 100 °C.

Duration

If you are increasing the recommended temperature, shorten the cooking duration by approx. $\frac{1}{3}$.

Example

Rice	20 minutes
Rose fish fillet	6 minutes
Broccoli	4 minutes

20 minutes minus 6 minutes =
14 minutes (1st duration: rice)

6 minutes minus 4 minutes = 2 minutes
(2nd duration: rose fish fillet)

Remaining time = 4 minutes (3rd duration: broccoli)

Durations	20 min. - rice		
		6 min. - fish fillet	
			4 min. - broccoli
Setting	14 min	2 min.	4 min.

Steam cooking

Cooking a whole meal

- Place the rice in the oven first.
- Set the first cooking duration:
14 minutes.
- After 14 minutes, place the fish in the steam oven.
- Set the second cooking duration:
2 minutes.
- After 2 minutes, place the broccoli in the steam oven.
- Set the third cooking duration:
4 minutes.

Reheat

The steam oven is very effective at reheating food gently, without drying it out or cooking it further. The food will reheat evenly and does not need to be stirred during the reheating process.

You can reheat individual dishes or plated meals which have been prepared previously (e.g. meat, vegetables and potatoes).

Suitable containers

Small quantities can be reheated on a plate, larger quantities should be placed in a cooking container.

Time

The number of plates or containers has no bearing on the time.

The times listed in the chart relate to an average portion per plate. Increase the duration for larger quantities.

Tips

- Do not reheat large items, such as a joint of roast meat, whole. Divide it into portions and reheat these as plated meals.
- Compact items, such as stuffed peppers, roulades or dumplings, should be cut in half.
- Reheat sauces separately, except for dishes such as stew and casseroles where the sauce is part of the dish.
- Cover food when reheating it to avoid steam condensing on the crockery.
- Please note that breaded items, such as schnitzel, will not retain their crispness when they are reheated.

Reheating food

- Cover the food with a plate, a lid, or with foil that is resistant to temperatures up to 100 °C and to steam.
- Place the plate or dish in a sufficiently large perforated container.

Settings

Temperature: 100 °C

Duration: see chart

Special applications

Food	🕒* [min]
Vegetables	
Carrots Cauliflower Kohlrabi Beans	6–7
Side dishes	
Pasta Rice	3–4
Potatoes, halved lengthways	12–14
Dumplings	15–17
Meat and poultry	
Sliced meat, 1.5 cm thick Roulades, sliced Goulash Lamb stew	5–6
Meatballs	13–15
Chicken escalopes Turkey escalopes	7–8
Fish	
Fish fillets, 2 cm thick	6–7
Fish fillets, 3 cm thick	7–8
Plated meals	
Spaghetti with tomato sauce	13–15
Roast pork, potatoes, vegetables	12–14
Stuffed pepper (halved), rice	13–15
Chicken fricassee, rice	7–8
Vegetable soup	2–3
Creamy soup	3–4
Consommé	2–3

Special applications

Food	🕒* [min]
Stew	4-5

🕒 Duration

* These times apply to food heated on a plate and covered with a plate.

Special applications

Defrost

It is much quicker to defrost food in the steam oven than at room temperature.

 Risk of infection from bacteria. Bacteria such as salmonella can cause life-threatening food poisoning.

It is particularly important to observe food hygiene rules when defrosting fish and meat, and in particular when defrosting poultry.

Do not use the liquid produced during defrosting.

Process the food as required as soon as it has been defrosted.

Temperature

60 °C is the best temperature for defrosting.

Exception: 50 °C for minced meat and game

Before and after defrosting

Remove all packaging before defrosting.

Exceptions: Leave bread, biscuits and cakes in their packaging as otherwise they will absorb moisture and become soft.

Allow defrosted food to stand at room temperature after removing it from the oven. The standing time is necessary to allow the even distribution of heat.

Cooking containers

Use a perforated container with a solid container or universal tray underneath it when defrosting food which will drip, such as poultry. This way food will not be lying in defrosted liquid.

Food which does not drip can be defrosted in a solid container.

Tips

- Fish does not need to be fully defrosted before cooking. Defrost so that the surface is sufficiently thawed to take herbs and seasoning. Depending on the thickness of the fish, 2 - 5 minutes should be enough.
- When defrosting food which has frozen together, e.g. berries, chops, fish fillets etc. separate it about half-way through the defrosting time.
- Do not refreeze food once it has thawed.
- Defrost frozen pre-cooked meals according to the manufacturer's instructions.

Settings

Temperature: see chart

Defrosting duration: see chart

Special applications

Food to be defrosted	Quantity	🌡️ [°C]	🕒 [min]	⌚ [min]
Dairy products				
Sliced cheese	125 g	60	15	10
Quark	250 g	60	20–25	10–15
Cream	250 g	60	20–25	10–15
Soft cheese	100 g	60	15	10–15
Fruit				
Apple sauce	250 g	60	20–25	10–15
Apple chunks	250 g	60	20–25	10–15
Apricots	500 g	60	25–28	15–20
Strawberries	300 g	60	8–10	10–12
Raspberries/redcurrants/ blackcurrants	300 g	60	8	10–12
Cherries	150 g	60	15	10–15
Peaches	500 g	60	25–28	15–20
Plums	250 g	60	20–25	10–15
Gooseberries	250 g	60	20–22	10–15
Vegetables				
Frozen in a block	300 g	60	20–25	10–15
Fish				
Fish fillets	400 g	60	15	10–15
Trout	500 g	60	15–18	10–15
Lobster	300 g	60	25–30	10–15
Small shrimps	300 g	60	4–6	5
Ready meals				
Meat, vegetables, side dishes/ stew/soup	480 g	60	20–25	10–15
Meat				
Roast meat, sliced	125–150 g each	60	8–10	15–20
Minced meat	250 g	50	15–20	10–15
	500 g	50	20–30	10–15

Special applications

Food to be defrosted	Quantity	🌡️ [°C]	🕒 [min]	⌚ [min]
Goulash	500 g	60	30–40	10–15
	1000 g	60	50–60	10–15
Liver	250 g	60	20–25	10–15
Saddle of hare	500 g	50	30–40	10–15
Saddle of venison	1000 g	50	40–50	10–15
Cutlets/chops/sausages	800 g	60	25–35	15–20
Poultry				
Chicken	1000 g	60	40	15–20
Chicken thighs	150 g	60	20–25	10–15
Chicken escalopes	500 g	60	25–30	10–15
Turkey legs	500 g	60	40–45	10–15
Baked goods				
Puff pastries/yeast buns	–	60	10–12	10–15
Creamed mixture cakes/biscuits	400 g	60	15	10–15
Bread/rolls				
Bread rolls	–	60	30	2
Rye bread, sliced	250 g	60	40	15
Wholegrain bread, sliced	250 g	60	65	15
White bread, sliced	150 g	60	30	20

🌡️ Temperature 🕒 Defrosting time ⌚ Standing time

Bottling

Only use unblemished, fresh produce which is in good condition for bottling.

Glass jars

Use clean glass jars and accessories and check them for any defects. Glass jars with twist off lids or glass lids with a rubber seal are suitable.

Make sure that all the jars are the same size so that bottling is carried out evenly.

After you have filled the jars with the bottled produce, clean the glass rims with a clean cloth and hot water and then seal the jars.

Fruit

Sort fruit carefully, rinse it briefly but thoroughly and allow it to drain. Take great care when cleaning soft fruit as it is very delicate and squashes easily.

Remove any peel, stalks, cores or stones. Cut up large fruit. For example, cut apples into slices.

If you are bottling fruit with stones (e.g. plums, apricots) without removing the stones, pierce the fruit several times with a fork or wooden skewer as otherwise it will burst.

Vegetables

Rinse, clean and cut up vegetables.

Vegetables should be blanched before bottling to help them retain their colour (see “Special applications” – “Blanching”).

Fill volume

Fill the glass jars with produce up to a maximum of 3 cm below the rim. Do not pack it down as this will damage the cell walls of the produce. Tap the jar gently onto a cloth to help distribute the contents evenly. Fill the jars with liquid. The produce must be completely covered.

Use a sugar solution for fruit and a salt or vinegar solution for vegetables.

Tips

- Make use of residual heat by leaving the jars in the oven for 30 minutes after it has switched off.
- Then cover the jars with a cloth and allow to cool for approx. 24 hours.

Special applications

Bottling food

- Push the condensate tray in on the lowest shelf level with a perforated container above it.
- Place the jars in a perforated container. The jars must not touch each other.

Settings

Temperature: see chart

Bottling duration: see chart

Food to be bottled	🌡️ [°C]	🕒* [min]
Berries		
Redcurrants/blackcurrants	80	50
Gooseberries	80	55
Cranberries	80	55
Fruit with stones		
Cherries	85	55
Mirabelle plums	85	55
Plums	85	55
Peaches	85	55
Greengages	85	55
Fruit with pips		
Apples	90	50
Apple sauce	90	65
Quinces	90	65
Vegetables		
Beans	100	120
Broad beans	100	120
Gherkins	90	55
Beetroot	100	60

* Bottling times apply to 1 l jars. If using 0.5 l jars, reduce the duration by 15 minutes. If using 0.25 l jars, reduce the duration by 20 minutes.

Extracting juice with steam

This appliance is ideal for extracting juice from soft, firm and hard fruit.

It is best to use overripe fruit, as the riper the fruit, the greater the quantity of juice produced. Very ripe fruit will also produce a more intense flavour.

Preparation

Sort and clean the fruit. Cut out any blemishes.

Remove the stalks from grapes and morello cherries as these are bitter. Berries do not need to have their stalks removed.

Cut larger fruit such as apples into chunks of approximately 2 cm in size. The harder the fruit, the smaller the pieces should be.

Tips

- Try experimenting with mild and tart fruit.
- Adding sugar will increase the quantity of juice produced and improve the flavour. Sprinkle the fruit with sugar and leave to absorb for a few hours before juicing. For 1 kg of sweet fruit add 50–100 g of sugar, and for 1 kg of tart fruit add 100–150 g of sugar.
- If you wish to bottle the juice rather than consume it straight away, pour it whilst hot into hot, sterilised bottles, and then seal immediately with sterilised tops.

Extracting juice from fruit

- Put the prepared fruit into a perforated cooking container.
- Place a solid container or the condensate tray underneath to catch the juice.

Settings

Temperature: 100 °C

Duration: 40 - 70 minutes

Special applications

Make yoghurt

To make yoghurt, you will need either fresh live yoghurt or yoghurt culture, obtainable from health food shops.

Use natural yoghurt with live culture and without additives. Heat-treated yoghurt is not suitable.

The yoghurt must be fresh (short storage time).

You can use either unchilled long-life milk or fresh milk.

Long-life milk can be used as it is – no further preparation is required. Fresh milk must first be heated to 90 °C (do not boil it) and then cooled down to 35 °C. Fresh milk will give a better set than long-life milk.

The yoghurt and milk should have the same percentage fat.

Do not move or shake the jars whilst the yoghurt is thickening.

Immediately after preparation, leave the yoghurt to cool in the fridge.

How well home-prepared yoghurt sets will depend on the consistency, fat content and the cultures used in the starter yogurt. Not all yoghurts are suitable for use as starter yoghurt.

- Mix 100 g yoghurt with 1 l milk or make up the mixture with yoghurt enzyme, following the instructions on the packaging.
- Pour the mixture into jars and seal the jars.
- Place the sealed jars in a perforated container, making sure they do not touch one another.
- Immediately after the yoghurt has been made, place the jars in the refrigerator, taking care not to shake them unnecessarily.

Tip: When using yoghurt enzyme, yoghurt can be made from a milk / cream mixture. Mix $\frac{3}{4}$ litre milk with $\frac{1}{4}$ litre cream.

Settings

Temperature: 40 °C

Duration: 5:00 hours

Possible reasons for unsatisfactory results

Yoghurt has not set:

Incorrect storage of starter yoghurt, too much time out of the refrigerator, e.g. in transportation, damaged packaging, milk not sufficiently heated.

Liquid has separated:

The jars were moved, yoghurt was not cooled down quickly enough.

Yoghurt is gritty:

Milk was overheated or in poor condition, milk and starter yoghurt not evenly stirred.

Prove dough

- Prepare the dough according to the recipe.
- Cover the bowl and place in a perforated container.

Settings

Temperature: 40 °C

Duration: as per recipe instructions

Dissolve gelatine

- Soften **gelatine leaves** by leaving them in a bowl of cold water for 5 minutes. The gelatine leaves have to be fully covered with water. Remove the gelatine leaves from the bowl and squeeze them out. Empty the bowl. Place the squeezed gelatine leaves back in the bowl.
- Place **gelatine powder** in a bowl and add water according to the instructions on the packaging.
- Cover the bowl and place in a perforated container.

Settings

Temperature: 90 °C

Duration: 1 minute

Special applications

Melt chocolate

You can use the steam oven for melting any type of chocolate.

- Break the chocolate into small pieces. Place chocolate cake covering in a perforated cooking container, leaving it in its packaging.
- Place large quantities in a solid cooking container and small quantities in a cup or a bowl.
- Cover the container or the dish with a lid or with foil that is resistant to temperatures up to 100 °C and to hot steam.
- Stir large quantities once halfway through cooking.

Settings

Temperature: 65 °C
Duration: 20 minutes

Skinning vegetables and fruit

- Cut a cross in the top of tomatoes, nectarines, etc. This will allow the skin to be removed more easily.
- Place the fruit/vegetables in a perforated cooking container.
- To blanch almonds, it is important to plunge them into cold water as soon as they are taken out of the oven, otherwise the skin cannot be removed.

Settings

Temperature: 100 °C
Duration: see chart

Food	🕒 [min]
Apricots	1
Almonds	1
Nectarines	1
Peppers	4
Peaches	1
Tomatoes	1

🕒 Duration

Apple storage

You can treat homegrown apples in the steam oven to increase the length of time for which you can store them.

Once treated, the apples will keep for 5 to 6 months when stored in a dry, cool and well-ventilated place. This method is only suitable for apples and not for other types of fruit.

Settings

Temperature: 50 °C

Duration: 5 minutes

Blanching

Blanch vegetables before freezing them. Blanching helps maintain the quality of the produce when it is frozen.

Blanching vegetables also helps them retain their original colour.

- Put the prepared vegetables into a perforated cooking container.
- Once blanched, plunge the vegetables into ice cold water to cool them down quickly. Drain them well.

Settings

Temperature: 100 °C

Duration: 1 minute

Special applications

Sweat onions

Sweating means cooking the onions in their own juices, with the addition of a little fat if necessary.

- Cut the onions up into small pieces and place them in a solid cooking container with a little butter.
- Cover the container with a lid or with foil that is temperature resistant up to 100 °C and to steam.

Settings

Temperature: 100 °C

Duration: 4 minutes

Cook bacon

The bacon does not brown.

- Place the bacon (diced or rashers) in a solid cooking container.
- Cover the container with a lid or with foil that is temperature resistant up to 100 °C and to steam.

Settings

Temperature: 100 °C

Duration: 4 minutes

Disinfect items

The steam oven can be used to disinfect baby bottles and other containers so that at the end of the programme they are as germ free as they would have been had they been boiled. Check beforehand that all parts, teats etc. are declared by the manufacturer to be heat resistant to 100 °C and also that they can withstand hot steam.

Dismantle, clean and thoroughly rinse baby bottles. All parts of the bottles must be completely dry before they are reassembled to keep them germ free.

- Place the individual parts in a perforated container (on their sides or with the opening facing downwards), ensuring that they do not touch one another. This will allow hot steam to reach them from all sides.

Settings

Temperature: 100 °C
Duration: 15 minutes

Heating damp flannels

- Moisten the flannels and then roll them up.
- Place them beside one another in a perforated cooking container.

Settings

Temperature: 70 °C
Duration: 2 minutes

Decrystallise honey

- Loosen the lid and place the jar of honey in a perforated container.
- Stir the honey once during the cooking duration.

Settings

Temperature: 60 °C
Duration: 90 minutes (irrespective of the size of jar or the amount of honey in the jar)

Special applications

Making eierstich

- Mix 6 eggs with 375 ml milk (do not beat into a foam).
- Season the egg and milk mixture and pour into a solid cooking container greased with a little butter.

Settings

Temperature: 100 °C

Duration: 4 minutes

Your steam oven is supplied with a number of standard default settings. The standard settings listed in the chart can be altered.

To change and save settings

With the appliance **switched off**:

- Press and hold the On/Off ① button.
- Whilst pressing the On/Off ① button, touch the ∨ sensor once briefly when the display lights up.

P1 will appear in the display.

- Touch the ∧ or ∨ sensor repeatedly until the programme you want appears highlighted in the display.
- Confirm with OK.
- Touch the ∧ or ∨ sensor repeatedly until the status you want appears highlighted in the display.
- Confirm with OK.

The selected status will be saved.



- After you have altered the setting(s) required, switch the appliance off.

Settings

The factory setting is shown in **bold**.

Programme		Status	Available settings
P1		S0 S1	Factory default settings reinstated
P2	Demo mode	S0 S1	Off, the steam oven heats up On, the steam oven does not heat up
P3	Buzzer volume	S1 S2 S3 S4	Very quiet Quiet Medium Loud
P4	Water hardness	S1 S2 S3 S4	Soft (< 1.5 mmol/l, < 8.4 °dH) Medium (1.5 - 2.5 mmol/l, 8.4–14 °dH) – Hard (> 2.5 mmol/l, > 14 °dH)
P5	Temperature	S1 S2	°C °F
P6	Pre-heat	S0 S1	Pre-heating not activated Pre-heating activated
P7	Keypad tone	S0 S1	Off On

Test food in accordance with EN 60350-1 (Steam cooking function)

Test food	Cooking container	Quantity [g]	 ¹	 ² [°C]	 [min]
Steam replenishment					
Broccoli (8.1)	1x DGGL 1	max.	Any	100	3
Steam distribution					
Broccoli (8.2)	1x DGGL 1	300	Any	100	3
Performance at maximum capacity					
Peas (8.3)	3x DGGL 1	2.5 kg frozen peas spread evenly across the container	2, 3, 4 ³	100	4

 Shelf level(s) /  Temperature /  Duration

- 1) Always insert the condensate tray on the lowest shelf level.
- 2) Place the test food in a cold oven (before the heating up phase begins).
- 3) Place cooking container at the back of shelf levels 2 and 4 and at the front of shelf level 3.
- 4 The test is finished when the temperature measures 85 °C in the coolest place.

Cleaning and care

 Risk of injury caused by hot surfaces.

The steam oven gets hot during operation. You could burn yourself on the oven compartment, side runners or accessories.

Allow the oven compartment, side runners and accessories to cool before cleaning.

 Risk of injury due to electric shock.

The steam from a steam cleaning appliance could reach live electrical components and cause a short circuit.

Do not use a steam cleaner to clean the steam oven.

All surfaces could be discoloured or damaged if unsuitable cleaning agents are used.

All surfaces are susceptible to scratching. Scratches on glass can in some circumstances lead to breakage.

Use only domestic washing-up liquid to clean the appliance.

Remove all cleaning agent residues immediately.

Do not use cleaning agents or washing-up liquids containing aliphatic hydrocarbons as these could cause the seals to swell.

If soiling is left on for any length of time, it may become impossible to remove.

Surfaces may suffer discolouration or damage.

It is therefore best to remove any soiling immediately.

- The appliance and accessories should be cleaned and dried thoroughly after each use.
- Leave the appliance door open until the oven compartment is completely dry.

Tip: If the appliance is not going to be used for a longer period of time – during a holiday, for example – it should be thoroughly cleaned and dried beforehand to prevent the build-up of odours and so on. Leave the door open afterwards.

Unsuitable cleaning agents

To avoid damaging the surfaces of your appliance, do not use:

- Cleaning agents containing soda, ammonia, acids or chlorides
- Cleaning agents containing descaling agents
- Abrasive cleaning agents, e.g. powder cleaners and cream cleaners
- Solvent-based cleaning agents
- Stainless steel cleaning agents
- Dishwasher cleaner
- Glass cleaning agents
- Cleaning agents for ceramic glass hobs
- Hard, abrasive brushes or sponges (e.g. pot scourers, brushes or sponges which have been previously used with abrasive cleaning agents)
- Melamine eraser blocks
- Sharp metal scrapers
- Wire wool
- Stainless steel spiral pads
- Spot cleaning with mechanical cleaning agents
- Oven cleaners or sprays

Cleaning the steam oven front and casing

- Clean the front and casing with a clean sponge and a solution of warm water and washing-up liquid.
- After cleaning, wipe the front and casing dry using a soft cloth.

Tip: A clean, damp microfibre cloth without cleaning agent can also be used.

Cleaning and care

Cleaning the oven compartment

If something gets caught behind the seals around the steam inlet and outlet, the seals could get pushed behind the back panel by mistake. Make sure that nothing gets caught behind the seals when cleaning the back of the oven compartment.

The oven compartment, the door seal, the inside of the door and the drip channel should be cleaned and dried after each use.

- Remove:
 - Condensate using a sponge or absorbent cloth
 - Light, greasy soiling with a clean sponge and a solution of washing-up liquid and hot water
- After cleaning, wipe the surface with clean water to remove any cleaning agent residues.
- Then wipe the surfaces dry using a cloth.

After prolonged use, the **floor heater** can become discoloured by drops of liquid, but this will not impair the function.

Replace the **seal** with a new one if it becomes porous or brittle. Door seals can be ordered from the Miele Customer Service Department (see the end of this booklet for contact details).

Accessories

All accessories are dishwasher safe.

Cleaning the condensate tray and cooking containers

- Wash and dry the condensate tray and cooking containers after each use.
- Any bluish discolouration on the cooking containers can be removed with vinegar. Then rinse with clean water.

Cleaning the side runners

The side runners are suitable for cleaning in a dishwasher.

- Pull the runners off as shown.
- The side runners can be cleaned in the dishwasher or by hand with a solution of warm water and a little washing-up liquid applied with a clean sponge.

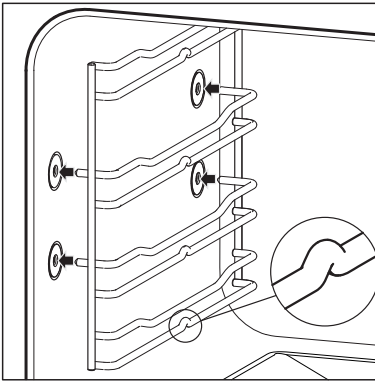

- Push the side runners firmly back in after cleaning. When putting them back in, make sure they are correctly inserted (see illustration).

Risk of damage to side runners when not inserted correctly.

If the side runners are not correctly inserted, the temperature sensor could be damaged when cooking containers are placed in the steam oven.

Insert the side runners correctly.

If the side runners are not correctly inserted, there is no anti-tip protection.

Insert the side runners correctly.

Cleaning and care

Emptying and drying the water container

 Risk of damage due to ingress of water.

The water container's heating element can become damaged if it is exposed to water.

Do not clean the water container or the insert in the dishwasher and do not immerse the water container in water.

For reasons of hygiene and to prevent the build-up of moisture in the appliance, the water container should be emptied after each use. Do not use scouring pads or hard brushes.

- Remove, empty and dry the water container after each use.

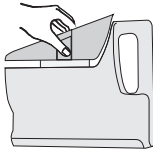

- Release the insert by pushing the catches on the sides in towards each other and then pull it out of the container.



- After cleaning, dry both parts of the insert thoroughly before replacing it in the water container. When replacing

the insert, guide it in at an angle ① and then push it downwards ② as illustrated.

Lubricating the coupling seal

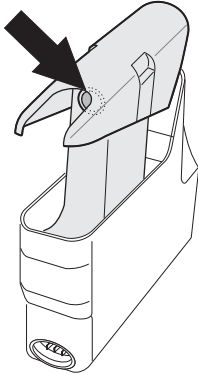

Coupling seals can be ordered from the Miele Customer Service Department (see the end of this booklet for contact details).

Only use the silicone grease supplied. On no account must margarine, oil or any other domestic grease or fat be used, as these can cause the seal to swell.

- If, after prolonged use, the water container becomes difficult to remove and replace or the fault message *F20* appears, rub a small amount of the silicone grease supplied (see “Guide to the appliance” – “Accessories supplied”) into the inside of the coupling seal.

Do not take the sealing ring out to lubricate it.

⚠ Danger of injury caused by silicone grease.

Silicone grease can irritate mucous membranes.

Remove any silicone grease from your skin either by wiping it off or by washing it off.

If the grease gets into the eyes, it must be rinsed out with plenty of clean water.

Seek medical attention if silicone grease has been swallowed.

- The coupling seal should be replaced with a new one if it becomes brittle or porous or if an unusually large amount of water collects on the floor of the water container compartment.

Cleaning and care

Descaling the water container

We recommend using Miele descaling tablets (see “optional accessories”). These have been specially developed for use with Miele appliances to optimise the descaling process. Alternatively you can use a proprietary citric acid based descaling agent.

Do not spill descaling agent onto metal surfaces. This can cause marks to appear.

However, should any descaling agent get onto these surfaces, wipe it away immediately.

The steam oven needs to be descaled after a certain number of operating hours. When it needs descaling, the ☞ symbol and a number will appear in the display when the appliance is switched on. The number indicates the number of times that the steam oven can be used before it has to be descaled.



The appliance will lock after the last remaining cooking process.

We recommend that you descale the appliance before it locks out.

During the descaling process, the water container must be rinsed out and re-filled with fresh water.



- Touch the On/Off (ⓘ) button until a tone sounds and the flashing ☞ symbol and the duration 0:22 h appear in the display.
- Pour 1 l lukewarm water into the water container and add 1 Miele descaling tablet or the recommended amount of citric acid descaling agent.
- Wait until the descaling agent has dissolved.
- Push the water container into the appliance until it connects.
- Confirm with OK.





The colon will flash and the ☞ symbol will now light up constantly in the display. Descaling will now begin.

It is only possible to cancel the descaling process during the first minute. Do not switch the appliance off during the descaling process. If it is switched off before the end of the process, the whole process will have to be started from the beginning again.



An audible tone will sound and the ☞ symbol will flash in the display approximately 10 minutes before the end of the descaling process.

- Remove the water container and take the insert out.
- Empty the water container.
- Rinse the water container and the insert thoroughly.
- Fill the water container with 1 l of fresh tap water and refit the insert.
- Push the water container into the appliance until it connects.

The flashing  symbol will go out and the  symbol will start flashing.

- Confirm with OK.

The colon will flash and the  symbol will now light up constantly in the display. Descaling will continue.



An audible tone will sound when the descaling process has been completed.

- Switch the steam oven off.
- Remove, empty and dry the water container.
- Allow the oven compartment to cool down.
- Then dry the oven compartment.
- Leave the appliance door open until the oven compartment is completely dry.

Problem solving guide

Many malfunctions and faults that can occur in daily operation can be easily remedied. Time and money will be saved because a service call will not be needed.

The following guide may help you to find the reason for a malfunction or a fault, and to correct it.

Problem	Cause and remedy
<p>You cannot switch the appliance on.</p>	<p>The fuse has tripped.</p> <ul style="list-style-type: none"> ■ Reset the trip switch in the fuse box or replace the fuse in the plug (see data plate for minimum fuse rating). <p>There may be a technical fault.</p> <ul style="list-style-type: none"> ■ Disconnect the appliance from the mains connection for approximately 1 minute by: <ul style="list-style-type: none"> – Tripping the relevant mains fuse or unscrewing the fuse completely, or – Switching off the residual current protection device ■ If, after resetting the trip switch in the mains fuse box or the residual current protection device, the steam oven will still not turn on, contact a qualified electrician or Miele Service.
<p>The oven does not heat up.</p>	<p>Demo mode has been activated. <i>dEND</i> appears in the display. The steam oven can be operated but does not heat up.</p> <ul style="list-style-type: none"> ■ Deactivate demo mode (see “Settings”). <p>The oven cavity has been warmed up by a warming drawer in operation underneath it.</p> <ul style="list-style-type: none"> ■ Open the door and let the oven cool down.
<p>The  symbol and a number between 1 and 10 appear in the display. 0:22 h and  are flashing.</p>	<p>The appliance needs to be descaled.</p> <ul style="list-style-type: none"> ■ Proceed as described in “Cleaning and care” – “Descaling”.

Problem solving guide

Problem	Cause and remedy
<p>The fan can still be heard after the appliance has been switched off.</p>	<p>The fan is still running. The appliance is fitted with a fan which removes steam from the oven. The fan will continue to run for a while after the appliance has been switched off. It will switch itself off automatically after a while.</p>
<p>The water container has become harder to put into the appliance and take out again.</p>	<p>The coupling seal in the water container has become stiff.</p> <ul style="list-style-type: none"> ■ Lightly lubricate the coupling seal on the water container with silicone grease, as described in “Cleaning and care” – “Water container”.
<p>After moving house the appliance no longer switches from the heating-up phase to the cooking phase.</p>	<p>The boiling temperature of the water has changed as the altitude of the new location for the appliance differs from the old one by at least 300 m.</p> <ul style="list-style-type: none"> ■ To adjust the boiling temperature, you need to descale the appliance (see “Cleaning and care” – “Descaling”).
<p>During operation an unusually large amount of steam escapes, or steam escapes from parts of the oven where it does not usually.</p>	<p>The door is not properly closed.</p> <ul style="list-style-type: none"> ■ Close the door.
	<p>The door seal is not correctly fitted.</p> <ul style="list-style-type: none"> ■ Press it in all the way round the door to make sure it is fitted evenly.
	<p>The door seal is damaged, e.g. cracks can be seen.</p> <ul style="list-style-type: none"> ■ Replace the door seal. This can be ordered from Miele (see the end of this booklet for contact details).
<p>After a period of time, the door makes a noise when it is opened and closed.</p>	<p>The door has become stiff.</p> <ul style="list-style-type: none"> ■ Lubricate the hinges with the silicone grease supplied.
<p>The  symbol appears in the display and an audible tone may sound.</p>	<p>The water container has not been pushed into the appliance properly.</p> <ul style="list-style-type: none"> ■ Remove the water container and push it back in so that it connects.
	<p>There is not enough water in the water container. The water level must be between the two marks.</p> <ul style="list-style-type: none"> ■ Fill the water container

Problem solving guide

Problem	Cause and remedy
<p>The heating-up phase lasts an unusually long time.</p>	<p>The water container has a lot of limescale build-up in it because the appliance was not set correctly for the hardness of the local water supply.</p> <ul style="list-style-type: none"> ■ Set the correct water hardness level for your water supply (see “Settings”). ■ Descale the appliance (see “Cleaning and care” – “Descaling”). ■ If the water hardness level was in fact set correctly or the problem occurs again, contact Miele Service.
<p><i>F 5</i> <i>F 5</i></p>	<p>Technical fault.</p> <ul style="list-style-type: none"> ■ Switch the appliance off and contact Miele.
<p><i>F20</i></p>	<p>The water container has not been pushed into the appliance properly.</p> <ul style="list-style-type: none"> ■ Remove the water container and push it back in so that it connects. ■ Switch the steam oven off and then back on again. <p>The coupling seal in the water container has become stiff.</p> <ul style="list-style-type: none"> ■ Lightly lubricate the coupling seal on the water container with silicone grease, as described in “Cleaning and care” – “Water container”.

Miele offer a comprehensive range of useful accessories as well as cleaning and conditioning products for your Miele appliances.

These products can be ordered through the Miele Webshop.

They can also be ordered from Miele (see end of this booklet for contact details) or from your Miele dealer.

Cooking containers

There is a wide range of perforated and solid cooking containers available in different sizes:

DGGL 1

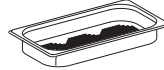

Perforated cooking container
Gross capacity 1.5 l
Usable capacity 0.9 l
325 x 175 x 40 mm (W x D x H)

DGG 2

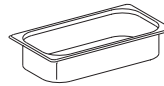

Solid cooking container
Gross capacity 2.5 l
Usable capacity 2.0 l
325 x 175 x 65 mm (W x D x H)

DGG 3

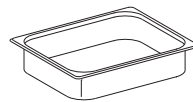

Solid cooking container
Gross capacity 4.0 l
Usable capacity 3.1 l
325 x 265 x 65 mm (W x D x H)

Optional accessories

DGGL 4



Perforated cooking container
Gross capacity 4.0 l
Usable capacity 3.1 l
325 x 265 x 65 mm (W x D x H)

DGGL 5

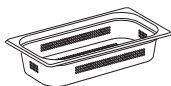

Perforated cooking container
Gross capacity 2.5 l
Usable capacity 2.0 l
325 x 175 x 65 mm (W x D x H)

DGGL 6

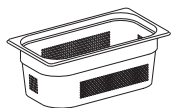

Perforated cooking container
Gross capacity 4.0 l
Usable capacity 2.8 l
325 x 175 x 100 mm (W x D x H)

DGG 7



Solid cooking container
Gross capacity 4.0 l
Usable capacity 2.8 l
325 x 175 x 100 mm (W x D x H)

DGGL 8

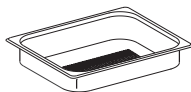

Perforated cooking container
Gross capacity 2.0 l
Usable capacity 1.7 l
325 x 265 x 40 mm (W x D x H)

Lid for cooking containers

DGD 1/3



Lid for 325 x 175 mm cooking containers

DGD 1/2



Lid for 325 x 265 mm cooking containers

Cleaning and care products

Descaling tablets (Qty 6)



For descaling the appliance

Microfibre cloth

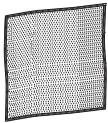

Removes finger marks and light soiling

Silicone grease



For lubricating the coupling seal on the water container

Miscellaneous

DGG 15

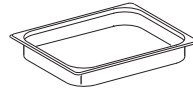

Condensate tray for catching excess moisture, can also be used as a cooking container.

325 x 265 x 40 mm (W x D x H)

Multi-purpose casserole dish

Die-cast aluminium casserole dish with non-stick surface and stainless steel lid. Also suitable for use on an extended zone of induction hobs and in all Miele cookers and ovens.

KMB 5000-S*

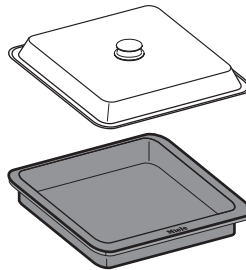

Maximum capacity approx. 2.5 kg
325 x 260 x 60 mm (W x D x H)

* Not suitable for use on gas hobs.

Technical data

This appliance is supplied with a mains cable and moulded plug ready for connection to a single phase supply.

Voltage and frequency: 230 V, 50 Hz

Connected load: 2.2 kW

Weight: 19.3 kg

VDE test certificate: yes

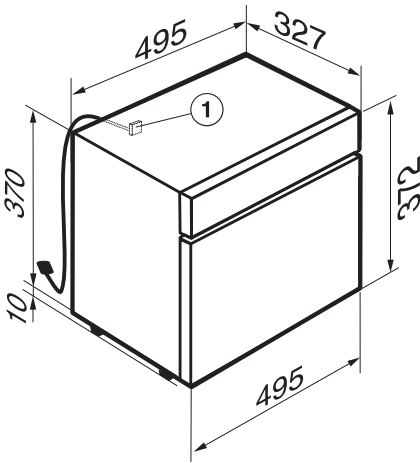

① Inlet for mains connection cable to the appliance

Dimensions (H x W x D):

- Appliance see illustration
- Cooking compartment 240 x 335 x 275 mm

Contact in case of malfunction

In the event of any faults which you cannot remedy yourself, please contact your Miele Dealer or Miele Service.

Contact information for Miele Service can be found at the end of this document.

Please note that telephone calls may be monitored and recorded for training purposes and that a call-out charge will be applied to service visits where the problem could have been resolved as described in this booklet.

Please quote the model and serial number of your appliance when contacting Miele. This information can be found on the data plate.

Data plate

Stick the extra data plate supplied with the appliance here. Make sure that the model number matches the one specified on the back cover of this document.



Warranty

For information on the appliance warranty specific to your country please contact Miele. See back cover for address.

In the UK, your appliance warranty is valid for 2 years from the date of purchase. However, you must activate your cover by calling 0330 160 6640 or registering online at www.miele.co.uk.

United Kingdom

Miele Co. Ltd., Fairacres, Marcham Road, Abingdon, Oxon, OX14 1TW

Tel: 0330 160 6600, Internet: www.miele.co.uk/service, E-mail: info@miele.co.uk

Australia

Miele Australia Pty. Ltd.
ACN 005 635 398
ABN 96 005 635 398
1 Gilbert Park Drive
Knoxfield, VIC 3180
Tel: 1300 464 353
Internet: www.miele.com.au

China Mainland

Miele Electrical Appliances Co., Ltd.
1-3 Floor, No. 82 Shi Men Yi Road
Jing' an District
200040 Shanghai, PRC
Tel: +86 21 6157 3500
Fax: +86 21 6157 3511
E-mail: info@miele.cn
Internet: www.miele.cn

Hong Kong, China

Miele (Hong Kong) Ltd.
41/F - 4101, Manhattan Place
23 Wang Tai Road
Kowloon Bay, Hong Kong
Tel: (852) 2610 1025
Fax: (852) 3579 1404
Email:
customerservices@miele.com.hk
Website: www.miele.hk

India

Miele India Pvt. Ltd.
1st Floor, Copia Corporate Suites,
Commercial Plot 9,
Mathura Road, Jasola,
New Delhi - 110025
E-mail: customercare@miele.in
Website: www.miele.in

Ireland

Miele Ireland Ltd.
2024 Bianconi Avenue
Citywest Business Campus
Dublin 24
Tel: (01) 461 07 10
Fax: (01) 461 07 97
E-Mail: info@miele.ie
Internet: www.miele.ie

Malaysia

Miele Sdn Bhd
Suite 12-2, Level 12
Menara Sapura Kencana
Petroleum
Solaris Dutamas No. 1
Jalan Dutamas 1
50480 Kuala Lumpur, Malaysia
Phone: +603-6209-0288
Fax: +603-6205-3768

New Zealand

Miele New Zealand Limited
IRD 98 463 631
8 College Hill
Freemans Bay, Auckland 1011
New Zealand
Tel: 0800 464 353
Internet: www.miele.co.nz

Singapore

Miele Pte. Ltd.
29 Media Circle
#11-04 ALICE@Mediapolis
Singapore 138565
sTel: +65 6735 1191
Fax: +65 6735 1161
E-Mail: info@miele.com.sg
Internet: www.miele.sg

South Africa

Miele (Pty) Ltd.
63 Peter Place
Bryanston 2194
P.O. Box 69434
Bryanston 2021
Tel: (011) 875 9000
Fax: (011) 875 9035
E-mail: info@miele.co.za
Internet: www.miele.co.za

Thailand

Miele Appliances Ltd.
BHIRAJ TOWER at EmQuartier
43rd Floor Unit 4301-4303
689 Sukhumvit Road
North Klongton Sub-District
Vadhana District
Bangkok 10110, Thailand

United Arab Emirates

Miele Appliances Ltd.
Showroom 1
Eiffel 1 Building
Sheikh Zayed Road, Umm Al Sheif
P.O. Box 114782 - Dubai
Tel. +971 4 3044 999
Fax. +971 4 3418 852
800-MIELE (64353)
E-Mail: info@miele.ae
Website: www.miele.ae

Manufacturer: Miele & Cie. KG, Carl-Miele-Straße 29, 33332 Gütersloh, Germany

DG 6001

en-GB

M.-Nr. 10 674 800 / 03