

**OWNER'S MANUAL**

**115V SINGLE ZONE SYSTEM  
SPLIT-STYLE HEAT PUMP**

DREW09S2AL/ DRE1U09S2A,  
DREW12S2AL/ DRE1U12S2A

**R-454B 115V 1ph 60 HZ**

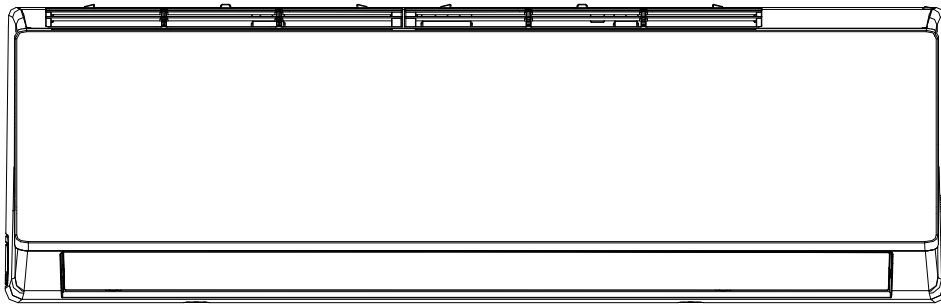

Model Number:

Serial Number:

Purchase Date:

Installing Contractor Company Name:



**TIP**

Capture relevant information about your Durastar mini-split equipment before it is installed and write it above for future reference.

## TABLE OF CONTENTS

|  |    |
|--|----|
| INTRODUCTION .....                       | 3  |
| SYMBOLS USED IN THIS MANUAL.....         | 3  |
| IMPORTANT SAFETY PRECAUTIONS .....       | 4  |
| FCC COMPLIANCE STATEMENT.....            | 13 |
| ACCESSORIES.....                         | 14 |
| OPERATING TEMPERATURES.....              | 15 |
| PARTS IDENTIFICATION .....               | 16 |
| INDOOR UNIT LED DISPLAY INDICATORS ..... | 17 |
| REMOTE CONTROL SCREEN INDICATORS .....   | 17 |
| REMOTE CONTROL BUTTONS .....             | 18 |
| REPLACING THE REMOTE BATTERIES.....      | 19 |
| OPERATING MODES .....                    | 20 |
| ADVANCED BUTTONS AND FUNCTIONS.....      | 21 |
| SETTING AIR FLOW DIRECTION.....          | 23 |
| MANUAL OPERATION.....                    | 24 |
| CARE AND MAINTENANCE .....               | 24 |
| TROUBLESHOOTING.....                     | 26 |
| WARRANTY .....                           | 29 |

## INTRODUCTION

To better serve you, please do the following before contacting customer service:

- If you received a damaged product, immediately contact the retailer or dealer that sold you the product.
- Read and follow this manual carefully to help you use and maintain your air handler.
- Read the troubleshooting section of this manual as it will help you diagnose and solve common issues.
- Visit us on the web at [www.durastar.com](http://www.durastar.com) to download product guides and up-to-date information.
- If you need warranty service, our friendly customer service representatives are available via email at [questions@durastar.com](mailto:questions@durastar.com) or by telephone at 1-888-320-0706.

## SYMBOLS USED IN THIS MANUAL



**WARNING:** The warning symbol indicates personal injury or loss of life is possible. Extra care and precautions should be taken to ensure the user's safety.



**CAUTION:** The caution symbol indicates property damage or other serious consequences could occur.



**NOTE:** The pencil indicates any manufacturer notes relating to surrounding content. These may include further clarifications or call-outs.



**TIP:** A light bulb symbol indicates suggested manufacturer tips for the user to get the most out of the Durastar equipment and to accommodate the best user experience.



Refrigerant  
Safety Group  
A2L

**WARNING:**

RISK OF FIRE DUE TO FLAMMABLE MATERIALS  
Follow handling instructions carefully in compliance with national regulations.

### Explanation of symbols displayed on the unit

|  |                |   |
|--|----------------|---|
|  | <b>CAUTION</b> | This symbol shows that the operation manual should be read carefully.   |
|  | <b>CAUTION</b> | This symbol shows that a service personnel should be handling this equipment with reference to the installation manual. |
|  | <b>CAUTION</b> | This symbol shows that information is available such as the operating manual or installation manual.                    |

**WARNING**

Turn off the air conditioner and disconnect the power before installing, cleaning, or repairing the air conditioner. Failure to do so can cause electric shock.

## IMPORTANT SAFETY PRECAUTIONS

Improper handling can cause serious damage or injury. Please read the following safety information in its entirety.



### Operation, Cleaning, and Maintenance Safety Precautions

- Children and people with reduced physical, sensory, or mental capabilities, or lack of experience and knowledge, should only use, clean, or maintain this air conditioner if they are given supervision or instructions concerning use of the air conditioner in a safe way and understand the hazards involved. Children should not play with the air conditioner.
- Maintenance or repair must be performed by qualified professionals. Otherwise, you may experience personal injury or damage to the air conditioner and surrounding property.
- Disconnect the power supply by turning it off at the circuit breaker when cleaning, maintaining, or repairing the air conditioner. Otherwise, you could risk electric shock.
- When turning the unit on or off via the emergency operation switch, press the switch with an insulated object other than metal.
- If the below problems occur, please turn off the air conditioner and disconnect power at the circuit breaker immediately. Then contact your dealer or a qualified professional for service.
  - The power cord is overheating or damaged.
  - There is an abnormal sound during operation.
  - The circuit breaker trips frequently.
  - The air conditioner gives off a burning smell.
  - The indoor unit is leaking.
- Do not block the air outlet or air inlet. This could cause a malfunction.
- Never stick fingers or any other body parts into the air conditioner openings. The internal fan may be rotating at high speeds, and may result in injury.
- Do not spill water on the remote control as this can permanently damage the remote.
- Do not spray water on the indoor unit. This could cause electric shock or a unit malfunction.
- Do not clean the air conditioner with excessive amounts of water.
- Do not clean the air conditioner with combustible cleaning agents; they can cause fire or deformation.
- After removing the filter, do not touch the fins in order to avoid injury.
- Do not use fire or a hair dryer to dry the filter. This could cause a deformation or fire hazard.
- Do not step on the top panel of the unit, or put heavy objects on the top panel. This could cause damage or personal injury.
- Do not use flammable materials such as hair spray, lacquer, or paint near the air conditioner as they may catch fire.
- Do not operate the air conditioner in places near combustible gases. Emitted gases may collect around the air conditioner and cause an explosion.
- Do not operate your air conditioner in a wet room such as a bathroom or laundry room. Too much exposure to water can cause electrical components to short circuit.
- If the air conditioner is used together with burners or other heating devices, thoroughly ventilate the room to avoid oxygen deficiency.



### **Electrical Safety**

- Do not modify the length of the power supply cord or use an extension cord to power the unit.
- If the supply cord is damaged, it must be replaced by the manufacturer, a service agent, or a similarly qualified person in order to avoid a safety hazard.
- Keep power plug clean. Remove any dust or grime that accumulates on or around the plug. Dirty plugs can cause fire or electric shock.
- Do not pull power cord to unplug unit. Hold the plug firmly and pull it from the outlet. Pulling directly on the cord can damage it, which can lead to fire or electric shock.
- Do not share the electrical outlet with other appliances. Improper or insufficient power supply can cause fire or electrical shock.
- The product must be properly grounded at the time of installation, or electrical shock may occur.
- For all electrical work, follow all local and national wiring standards and regulations. Connect cables tightly, and clamp them securely to prevent external forces from damaging the terminal. Improper electrical connections can overheat and cause fire, and may also cause shock. All electrical connections must be made according to the Electrical Connection Diagram located on the panels of the indoor and outdoor units.
- All wiring must be properly arranged to ensure that the control board cover can close properly. If the control board cover is not closed properly, it can lead to corrosion and cause the connection points on the terminal to heat up, catch fire, or cause electrical shock.
- If connecting power to fixed wiring, an all-pole disconnection device which has at least 3mm clearances in all poles, and have a leakage current that may exceed 10mA, the residual current device(RCD) having a rated residual operating current not exceeding 30mA, and disconnection must be incorporated in the fixed wiring in accordance with the wiring rules.
- The air conditioner's circuit board (PCB) is designed with a fuse to provide over-current protection. The specifications of the fuse are printed on the circuit board.



### **Installation Safety**

- Installation must be performed by an authorized dealer or specialist. Improper installation can cause water leakage, electrical shock, or fire. (In North America, installation must be performed in accordance with NEC and CEC requirements by authorized personnel only.)
- Installation must be performed according to the installation instructions. Improper installation can cause water leakage, electrical shock, or fire.
- This air conditioner shall be installed in accordance with national and local wiring regulations.
- Contact an authorized service technician for repair or maintenance of this unit.
- Only use the included accessories, parts, and specified parts for installation. Using non-standard parts can cause water leakage, electrical shock, fire, and can cause the unit to fail.
- Install the unit in a firm location that can support the unit's weight. If the chosen location cannot support the unit's weight, or the installation is not done properly, the unit may fall and cause serious injury and damage.
- Install drainage piping according to the instructions in the installation manual. Improper drainage may cause water damage to your home and property.
- For units that have an auxiliary electric heater, do not install the unit within 3 feet (1 meter) of any combustible materials.
- Do not install the unit in a location that may be exposed to combustible gas leaks. If combustible gas accumulates around the unit, it may cause a fire.

- Do not turn on the power until all work has been completed.
- When moving or relocating the air conditioner, consult experienced service technicians for disconnection and re-installation of the unit.
- Be careful when opening or closing valves below freezing temperatures. Refrigerant may spurt out from the gap between the valve stem and the valve body, resulting in injuries.

**WARNING: REFRIGERANT SAFETY (A2L)**

- Do not use means to accelerate the defrosting process or to clean the unit, other than those recommended by the manufacturer.
- The appliance shall be stored in a room without continuously operating ignition sources (for example: open flames, an operating gas appliance or an operating electric heater).
- Do not pierce or burn.
- Be aware that flammable refrigerants may not contain an odor.
- Compliance with national refrigerant regulations shall be observed.

**A2L REFRIGERANT SAFETY PRECAUTIONS****1. Installation (Where Refrigerant Pipes Are Allowed)**

- Any person who is involved with working on or breaking into a refrigerant circuit should hold a current valid certificate from an industry-accredited assessment authority, which authorizes their competence to handle refrigerants safely in accordance with an industry recognized assessment specification.
- Maintenance and repair requiring the assistance of other skilled personnel shall be carried out under the supervision of the person competent in the use of flammable refrigerants.
- That the installation of pipe-work shall be kept to a minimum.
- That pipe-work shall be protected from physical damage.
- Where refrigerant pipes shall be compliance with national gas regulations.
- That mechanical connections shall be accessible for maintenance purposes.
- Be more careful that foreign matter (oil, water, etc) does not enter the piping. Also, when storing the piping, securely seal the opening by pinching, taping, etc.
- All working procedure that affects safety means shall only be carried by competent persons.
- Appliance shall be stored in a well ventilated area where the room size corresponds to the room area as specific for operation.
- Joints shall be tested with detection equipment with a capability of 0.18 oz (5 g) per year of refrigerant or better, with the equipment in standstill and under operation or under a pressure of at least these standstill or operation conditions after installation. Detachable joints shall NOT be used in the indoor side of the unit (brazed, welded joint could be used).
- In cases that require mechanical ventilation, ventilation openings shall be kept clear of obstruction.

**2. Because a FLAMMABLE REFRIGERANT is used**, the requirements for installation space of appliance and/or ventilation requirements are determined according to:

- the mass charge amount(M) used in the appliance,
- the installation location,
- the type of ventilation of the location or of the appliance.
- piping material, pipe routing, and installation shall include protection from physical damage

in operation and service, and be in compliance with national and local codes and standards, such as ASHRAE 15, IAPMO Uniform Mechanical Code, ICC International Mechanical Code, or CSA B52. All field joints shall be accessible for inspection prior to being covered or enclosed.

- that protection devices, piping, and fittings shall be protected as far as possible against adverse environmental effects, for example, the danger of water collecting and freezing in relief pipes or the accumulation of dirt and debris;
- that piping in refrigeration systems shall be so designed and installed to minimize the likelihood of hydraulic shock damaging the system;
- that steel pipes and components shall be protected against corrosion with a rustproof coating before applying any insulation;
- that precautions shall be taken to avoid excessive vibration or pulsation;
- the minimum floor area of the room shall be mentioned in the form of a table or a single figure without reference to a formula;
- After completion of field piping for split systems, the field pipework shall be pressure tested with OXYGEN-FREE NITROGEN (OFN) and then vacuum tested prior to refrigerant charging, according to the following requirements:
  1. Pressure test the refrigerant piping to 500 PSI.
  2. The test pressure after removal of pressure source shall be maintained for at least 1 hour with no decrease of pressure indicated by the test gauge, with test gauge resolution not exceeding 5% of the test pressure.
  3. During the evacuation test, after achieving a vacuum level specified in the manual or less, the refrigeration system shall be isolated from the vacuum pump and the pressure shall not rise above 1500 microns within 10 min. The vacuum pressure level shall be specified in the manual, and shall be the lessor of 500 microns or the value required for compliance with national and local codes and standards, which may vary between residential, commercial, and industrial buildings.
- Field-made refrigerant joints indoors shall be tightness tested according to the following requirements: The test method shall have a sensitivity of 0.18 oz (5 g) per year of refrigerant or better under a pressure of at least 125% of the maximum allowable pressure. No leak shall be detected.

### **3. Qualifications Of Workers**

Any maintenance, service and repair operations must be performed by qualified personnel. Any working procedure that impacts safety must be performed only by qualified individuals who have completed the necessary training and obtained certification to demonstrate their competence. The training of these procedures is carried out by national training organizations or manufacturers that are accredited to teach the relevant national competency standards that may be set in legislation. All training shall follow the ANNEX HH requirements of UL 60335-2-40 4th Edition.

Examples for such working procedures are:

- breaking into the refrigerating circuit;
- opening of sealed components;
- opening of ventilated enclosures.

### **4. Checks To The Area**

Prior to beginning work on systems containing flammable refrigerants, safety checks are necessary to ensure that the risk of ignition is minimized. For repair to the refrigerating system, the following precautions shall be complied with prior to conducting work on the system.

## **5. Work Procedure**

Works shall be undertaken under a controlled procedure so as to minimize the risk of a flammable gas or vapor being present while the work is being performed.

## **6. General Work Area**

All maintenance staff and others working in the local area shall be instructed on the nature of work being carried out. Working in confined spaces shall be avoided.

## **7. Checking For Presence Of Refrigerant**

The area shall be checked with an appropriate refrigerant detector prior to and during work, to ensure the technician is aware of potentially flammable atmospheres. Ensure that the leak detection equipment being used is suitable for use with flammable refrigerants, i.e. no sparking, adequately sealed or intrinsically safe.

## **8. Presence Of Fire Extinguisher**

If any hot work is to be conducted on the refrigeration equipment or any associated parts, appropriate fire extinguishing equipment shall be available to hand. Have a dry power or CO2 fire extinguisher adjacent to the charging area.

## **9. No Ignition Sources**

No person carrying out work in relation to a REFRIGERATING SYSTEM which involves exposing any pipe work shall use any sources of ignition in such a manner that it may lead to the risk of fire or explosion. All possible ignition sources, including cigarette smoking, should be kept sufficiently far away from the site of installation, repairing, removing and disposal, during which refrigerant can possibly be released to the surrounding space. Prior to work taking place, the area around the equipment is to be surveyed to make sure that there are no flammable hazards or ignition risks.

"No Smoking" signs shall be displayed.

## **10. Ventilated Area**

Ensure that the area is in the open or that it is adequately ventilated before breaking into the system or conducting any work that could produce ignition. Keep ventilation openings clear of obstruction. Ventilation continue during the period that the work is carried out. Proper ventilation should safely disperse any released refrigerant and preferably expel it externally into the atmosphere.

## **11. Checks To The Refrigeration Equipment**

Where electrical components are being changed, they shall be fit for the purpose and to the correct specification. At all times the manufacturer's maintenance and service guidelines shall be followed. If in doubt consult the manufacturer's technical department for assistance. The following checks shall be applied to installations using FLAMMABLE REFRIGERANTS:

- the actual refrigerant charge is in accordance with the room size within which the refrigerant containing parts are installed;
- the ventilation machinery and outlets are operating adequately and are not obstructed;
- if an indirect refrigerating circuit is being used, the secondary circuits shall be checked for the presence of refrigerant;

- marking to the equipment continues to be visible and legible, marking and signs that are illegible shall be corrected;
- refrigeration pipe or components are installed in a position where they are unlikely to be exposed to any substance which may corrode refrigerant containing components, unless the components are constructed of materials which are inherently resistant to being corroded or are suitably protected against being so corroded.

## **12. Checks To Electrical Devices**

Repair and maintenance to electrical components shall include initial safety checks and component inspection procedures. If a fault exists that could compromise safety, then no electrical supply shall be connected to the circuit until it is satisfactorily dealt with. If the fault cannot be corrected immediately but it is necessary to continue operation, and adequate temporary solution shall be used. This shall be reported to the owner of the equipment so all parties are advised. Initial safety checks shall include:

- that capacitors are discharged: this shall be done in a safe manner to avoid possibility of sparking;
- that there no live electrical components and wiring are exposed while charging, recovering or purging the system;
- that there is continuity of earth bonding;
- Sealed electrical components shall be replaced if it's damage;
- Intrinsically safe components must be replaced if it's damage.

## **13. Wiring**

Check that wiring will not be subject to wear, corrosion, excessive pressure, vibration, sharp edges or any other adverse environmental effects. The check shall also take into account the effects of aging or continual vibration from sources such as compressors or fans.

## **14. Detection Of Flammable Refrigerants**

Under no circumstances shall potential sources of ignition be used in the searching for or detection of refrigerant leaks. A halide torch (or any other detector using a naked flame) shall not be used.

The following leak detection methods are deemed acceptable for refrigerant systems:

- Electronic leak detectors may be used to detect refrigerant leaks but, in the case of FLAMMABLE REFRIGERANTS, the sensitivity may not be adequate, or may need re-calibration to a sensitivity of 0.18 oz (5 g) per year. (Detection equipment shall be calibrated in a refrigerant free area.) Ensure that the detector is not a potential source of ignition and is suitable for the refrigerant used. Leak detection equipment shall be set at a percentage of the LFL of the refrigerant and shall be calibrated to the refrigerant employed, and the appropriate percentage of gas (25 % maximum) is confirmed.
- Leak detection fluids are also suitable for use with most refrigerants but the use of detergents containing chlorine shall be avoided as the chlorine may react with the refrigerant and corrode the copper pipe-work.

If a leak is suspected, all naked flames shall be removed/extinguished.

If a leakage of refrigerant is found which requires brazing, all of the refrigerant shall be recovered from the system, or isolated (by means of shut o valves) in a part of the system remote from the leak. See the following instructions for removal of refrigerant.

**Note**

Examples of leak detection fluids are bubble method and fluorescent method agents.

## 15. Evacuation

When breaking into the refrigerant circuit to make repairs – or for any other purpose conventional procedures shall be used. However, for flammable refrigerants it is important that best practice be followed, since flammability is a consideration.

The following procedure shall be adhered to:

- safely remove refrigerant following local and national regulations; evacuate;
- purge the circuit with NITROGEN
- evacuate (requirement);
- continuously flush or purge with NITROGEN when using flame to open circuit; and
- open the circuit

The refrigerant charge shall be recovered into the correct recovery cylinders if venting is not allowed by local and national codes. For appliances containing flammable refrigerants, the system shall be purged with OXYGEN-FREE NITROGEN (OFN) to render the appliance safe for flammable refrigerants. This process might need to be repeated several times. Compressed air or oxygen **shall not be used** for purging refrigerant systems.

For appliances containing flammable refrigerants, refrigerant purging shall be achieved by breaking the vacuum in the system with OXYGEN-FREE NITROGEN (OFN) and continuing to fill until the working pressure is achieved, then venting to atmosphere, and finally pulling down to a vacuum (requirement). This process shall be repeated until no refrigerant is within the system (requirement). When the final oxygen-free nitrogen charge is used, the system shall be vented down to atmospheric pressure to enable work to take place.

The outlet for the vacuum pump shall not be close to any potential ignition sources, and ventilation shall be available.

## 16. Charging Procedures

In addition to conventional charging procedures, the following requirements shall be followed:

- Works shall be undertaken with appropriate tools only (In case of uncertainty, please consult the manufacturer of the tools for use with flammable refrigerants).
- Ensure that contamination of different refrigerants does not occur when using charging equipment.
- Hoses or lines shall be as short as possible to minimize the amount of refrigerant contained in them.
- Cylinders shall be kept upright.
- Ensure that the refrigeration system is grounded prior to charging the system with refrigerant.
- Label the system when charging is complete (if not already).
- Extreme care shall be taken not to overfill the refrigeration system.
- Prior to recharging the system it shall be pressure tested with OXYGEN FREE NITROGEN (OFN). The system shall be leak tested on completion of charging but prior to commissioning.
- A follow up leak test shall be carried out prior to leaving the site.

## 17. Decommissioning

Before carrying out this procedure, it is essential that the technician is completely familiar with the equipment and all its detail. It is recommended good practice that all refrigerants are recovered safely. Prior to the task being carried out, an oil and refrigerant sample shall be taken in case analysis is required prior to re-use of recovered refrigerant. It is essential that electrical power is

available before the task is commenced.

- Become familiar with the equipment and its operation.
- Isolate system electrically
- Before attempting the procedure ensure that:
  1. mechanical handling equipment is available, if required, for handling refrigerant cylinders;
  2. all personal protective equipment is available and being used correctly;
  3. the recovery process is supervised at all times by a competent person;
  4. recovery equipment and cylinders conform to the appropriate standards.
- Pump down refrigerant system, if possible.
- If a vacuum is not possible, make a manifold so that refrigerant can be removed from various parts of the system.
- Make sure that cylinder is situated on the scales before recovery takes place.
- Start the recovery machine and operate in accordance with instructions.
- Do not overfill cylinders (no more than 80 % volume liquid charge)
- Do not exceed the maximum working pressure of the cylinder, even temporarily.
- When the cylinders have been filled correctly and the process completed, make sure that the cylinders and the equipment are removed from site promptly and all isolation valves on the equipment are closed off.
- Recovered refrigerant shall not be charged into another refrigeration system unless it has been cleaned and checked.

## **18. Labeling**

Equipment shall be labeled stating that it has been decommissioned and emptied of refrigerant. The label shall be dated and signed. For appliances containing FLAMMABLE REFRIGERANTS, ensure that there are labels on the equipment stating the equipment contains FLAMMABLE REFRIGERANT.

## **19. Recovery**

When removing refrigerant from a system, either for servicing or decommissioning, it is recommended good practice that all refrigerants are removed safely. When transferring refrigerant into cylinders, ensure that only appropriate refrigerant recovery cylinders are employed. Ensure that the correct number of cylinders for holding the total system charge is available. All cylinders to be used are designated for the recovered refrigerant and labeled for that refrigerant (i. e. special cylinders for the recovery of refrigerant). Cylinders shall be complete with pressure-relief valve and associated shut-off valves in good working order. Empty recovery cylinders are evacuated and, if possible, cooled before recovery occurs.

The recovery equipment shall be in good working order with a set of instructions concerning the equipment that is at hand and shall be suitable for the recovery of the flammable refrigerant. If in doubt, the manufacturer should be consulted. In addition, a set of calibrated weighing scales shall be available and in good working order. Hoses shall be complete with leak-free disconnect couplings and in good condition.

The recovered refrigerant shall be processed according to local legislation in the correct recovery cylinder, and the relevant waste transfer note arranged. Do not mix refrigerants in recovery units and especially not in cylinders.

If compressors or compressor oils are to be removed, ensure that they have been evacuated to an acceptable level to make certain that flammable refrigerant does not remain within the

lubricant. The compressor body shall not be heated by an open flame or other ignition sources to accelerate this process. When oil is drained from a system, it shall be carried out safely.

## 20. Unventilated Areas

- An unventilated area where the appliance using FLAMMABLE REFRIGERANTS is installed shall be so constructed that should any refrigerant leak, it will not stagnate so as to create a fire or explosion hazard.
- If appliances connected via an air duct system to one or more rooms with A2L REFRIGERANTS are installed in a room with an area less than  $A_{min}$ , that room shall be without continuously operating open flames (e.g. an operating gas appliance) or other POTENTIAL IGNITION SOURCES (for e.g. an operating electric heater, hot surfaces). A flame-producing device may be installed in the same space if the device is provided with an active flame arrest.
- Auxiliary devices which may be a POTENTIAL IGNITION SOURCE shall not be installed in the duct work. Examples of such POTENTIAL IGNITION SOURCES are hot surfaces with a temperature exceeding 700 °C and electric switching devices.
- Only auxiliary devices (such as certificated heater kit) approved by the appliance manufacturer or declared suitable with the refrigerant shall be installed in connecting ductwork.
- For duct connected appliances, false ceilings or drop ceilings may be used as a return air plenum if a REFRIGERANT DETECTION SYSTEM is provided in the appliance and any external connections are also provided with a sensor immediately below the return air plenum duct joint.
- REFRIGERANT SENSORS for REFRIGERANT DETECTION SYSTEMS shall only be replaced with sensors specified by the appliance manufacture.
- LEAK DETECTION SYSTEM installed. Unit must be powered except for service.

## 21. Transportation, Marking and Storage for Units That Employ Flammable Refrigerants

The following information is provided for units that employ FLAMMABLE REFRIGERANTS

Transport of equipment containing flammable refrigerants: Attention is drawn to the fact that additional transportation regulations may exist with respect to equipment containing flammable gas. The maximum number of pieces of equipment or the configuration of the equipment permitted to be transported together will be determined by the applicable transport regulations.

Marking of equipment using signs: Signs for similar appliances used in a work area are generally addressed by local regulations and give the minimum requirements for the provision of safety and/or health signs for a work location. All required signs are to be maintained and employers should ensure that employees receive suitable and sufficient instruction and training on the meaning of appropriate safety signs and the actions that need to be taken in connection with these signs. The effectiveness of signs should not be diminished by too many signs being placed together. Any pictograms used should be as simple as possible and contain only essential details.

Disposal of equipment using flammable refrigerants: See national regulations.

Storage of equipment/appliances: The storage of the appliance should be in accordance with the applicable regulations or instructions, whichever is more stringent.

Storage of packed (unsold) equipment: Storage package protection should be constructed in such a way that mechanical damage to the equipment inside the package will not cause a leak of the REFRIGERANT CHARGE. The maximum number of pieces of equipment permitted to be stored together will be determined by local regulations.



### **Additional Precautions**

- Turn off the air conditioner and disconnect the power if you are not going to use it for a long time.
- Turn off the unit during electrical storms to avoid damaging the unit.
- Make sure that water condensation can drain unhindered from the unit.
- Do not operate the air conditioner with wet hands. This may cause electric shock.
- Do not use this device for any other purpose than its intended use.
- Do not climb onto or place objects on top of the outdoor unit.
- Do not allow the air conditioner to operate for long periods of time with doors or windows open, or if the humidity is very high.
- If the air handler is used together with burners or other heating devices, thoroughly ventilate the room to avoid oxygen deficiency and carbon monoxide build up.
- In certain environments, such as kitchens, server rooms, etc., the use of specially designed air-conditioning units is highly recommended.
- As with any mechanical equipment, contact with sharp sheet metal edges can result in personal injury. Take care while handling this equipment and wear gloves and protective clothing.
- Excessive Weight Hazard – Use two (2) or more people when moving and installing the unit. Failure to do so can result in back or other type of injury.

## **FCC COMPLIANCE STATEMENT**

The remote provided with this unit complies with part 15 of the FCC Rules for Class B digital devices per the declaration of conformity below. These guidelines are meant to prevent against harmful interference in residential applications. This equipment generates a radio frequency that can interfere with radio communications if the unit is not installed in accordance with the installation manual provided and used in accordance with the owners manual provided. As mentioned in the installation manual, do not run the equipment's power and communication cables in parallel with antenna cables. If interference does occur, you are encouraged to try relocating the antenna or receiver and increasing the distance between the antenna and the equipment.

### **Supplier's Declaration of Conformity Per FCC Part 2 Section 2.1077**

**Unique Identifier:** DREW09S2AL, DREW12S2AL

**Responsible Party – U.S. Contact Information**

**Company name:** Ferguson Enterprises LLC

**Street Address:** 751 Lakefront Commons

**City, State:** Newport News, VA

**Postal Code:** 23606

**Telephone number or internet contact information:** Durastar.com









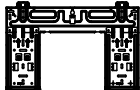
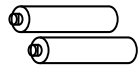
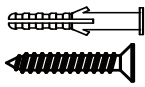

FCC Compliance Statement

This device complies with Part 15 of the FCC Rules. Operation is subject to the following two conditions: (1) This device may not cause harmful interference, and (2) this device must accept any interference received, including interference that may cause undesired operation.

## ACCESSORIES

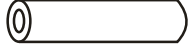
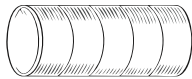
### INCLUDED INSTALLATION ACCESSORIES

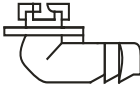
The air conditioning system comes with the following accessories.

| Accessory               | Quantity | Image   | Accessory                 | Quantity | Image   |
|-------------------------|----------|---|---------------------------|----------|---|
| Manual                  | 2        |    | Remote Control and Holder | 1        |    |
| Mounting Plate          | 1        |    | Batteries                 | 2        |    |
| Wall Anchors and Screws | 6        |    | Indoor Unit Drain Pipe    | 1        |    |
| Pipe Tape               | 1        |    | Flexible 5/8" Drain Pipe  | 1        |    |
| Sealant                 | 1        |    | Insulation                | 1        |    |
| Wall Sleeve             | 1        |  | Wall Sleeve Cover         | 1        |  |
| Drain Joint             | 1        |  | Carbon Filter             | 2        |  |

## OPERATING TEMPERATURES

Your air conditioner is designed to operate in the following indoor and outdoor temperatures. When your air conditioner is used outside of the following temperature ranges, certain safety features may activate and turn off the unit to protect it from damage.

After switching the operation mode or restoring power following an outage, the unit may require 2–5 minutes to start up in order to protect the compressor and/or allow for preheating.

### TEMPERATURE RANGES

|                                | HEAT mode                     | COOL mode                     | DRY mode |
|--------------------------------|-------------------------------|-------------------------------|----------|
| <b>Indoor Air Temperature</b>  | 32°F - 86°F<br>(0°C - 30°C)   | 63°F - 90°F<br>(17°C - 32°C)  |          |
| <b>Outdoor Air Temperature</b> | -4°F - 86°F<br>(-20°C - 30°C) | 5°F - 122°F<br>(-15°C - 50°C) |          |

To further optimize the performance of your unit, do the following:

- Keep doors and windows closed.
- Limit energy usage by using ECO, SLEEP, TIMER ON and TIMER OFF functions.
- Do not block air inlets or outlets.
- Regularly inspect and clean air filters.

#### NOTE



When outdoor air temperatures are at or below 32°F (0°C), we strongly recommend keeping the unit plugged in at all times to ensure smooth ongoing performance.

#### NOTE



Keep the room's relative humidity below 80%. If the air conditioner operates in excess of this, the surface of the air conditioner may attract condensation. To help prevent condensation from forming and dripping, set the vertical airflow louver to its maximum angle (vertically to the floor) and set the fan to HIGH.

## PARTS IDENTIFICATION

### INDOOR UNIT

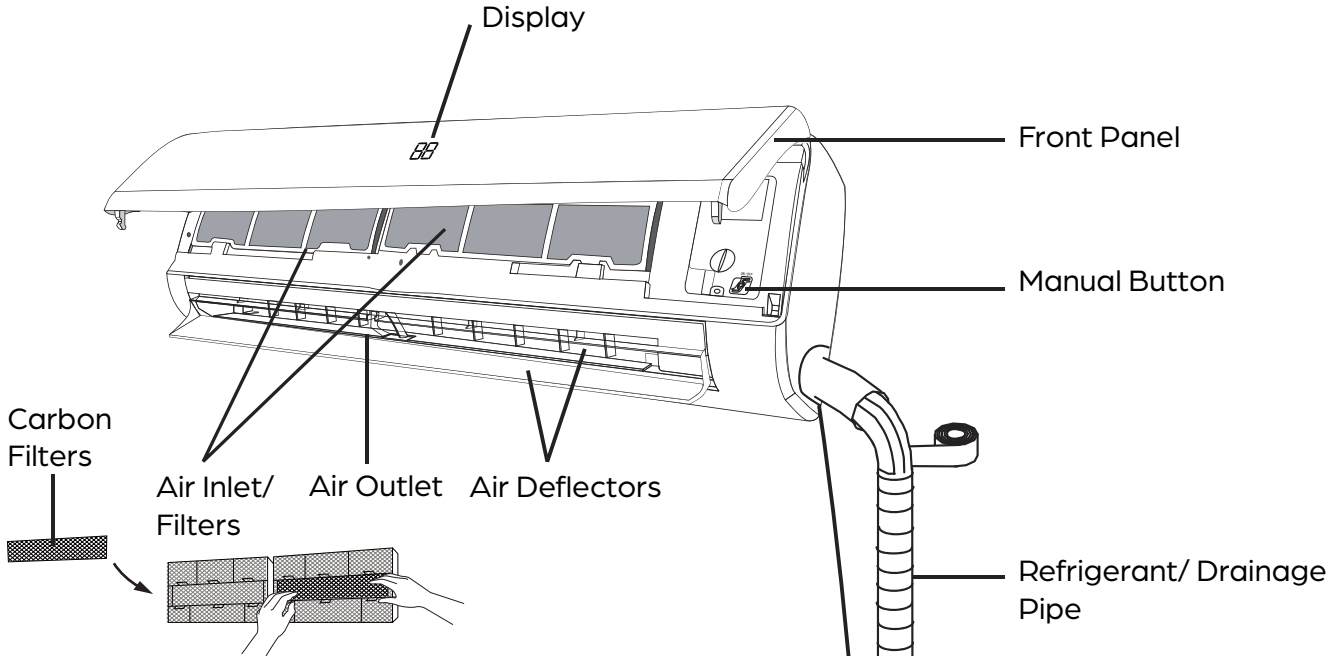

### OUTDOOR UNIT

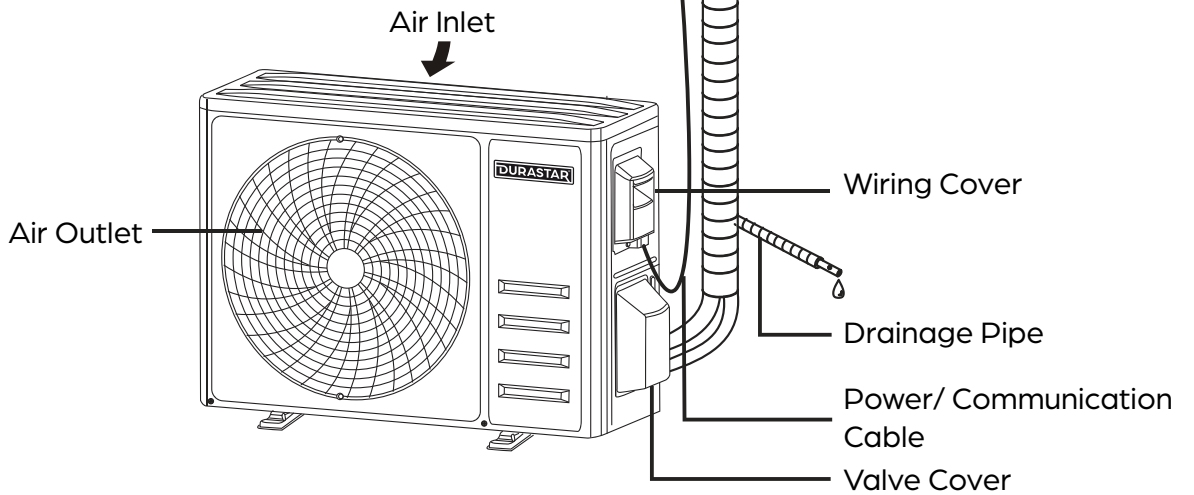

#### NOTE

Illustrations in this manual are for explanatory purposes. The actual shape of your mini-split equipment may vary slightly.

## INDOOR UNIT LED DISPLAY INDICATORS



### NOTE

All indicators shown in the figures are for purposes of clear representation. During actual operation, only the relative indicators are illuminated on the displays.



| Number | Indicator | Function Notes                                 |
|--------|-----------|--|
| 1      |           | Display for temperature, TIMER and error codes |
| 2      |           | Lights up during TIMER operation               |
| 3      |           | Lights up when SLEEP mode is active            |

## REMOTE CONTROL SCREEN INDICATORS

| Indicator | Function Notes  |
|-----------|---|
|           | Battery indicator                                     |
|           | Auto Mode   |
|           | Cooling Mode  |
|           | Dry Mode  |
|           | Fan Mode  |
|           | Heating Mode  |
|           | ECO Mode  |
|           | TIMER   |
|           | Temperature indicator                                 |
|           | Fan speed:<br>auto/ low/ low-mid/ mid/ mid-high/ high |
|           | Mute function   |
|           | TURBO   |
|           | Vertical Swing  |
|           | Horizontal Swing                                      |
|           | SLEEP   |
|           | I FEEL  |
|           | Child-Lock  |
|           | Display   |

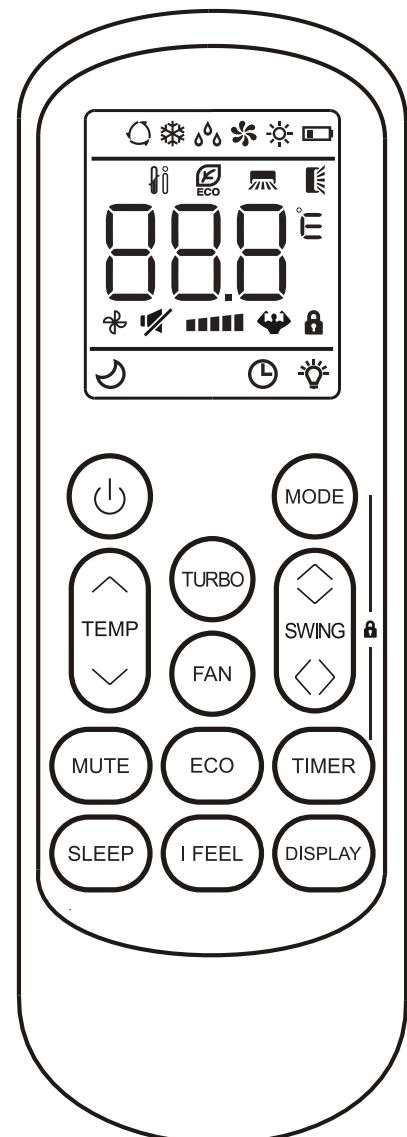

## REMOTE CONTROL BUTTONS

| Button         | Notes  |
|----------------|--|
|                | Turns on/off the air conditioner.  |
| ^              | Increases temperature or TIMER hours.  |
| ∨              | Decreases temperature or TIMER hours.  |
| MODE           | Selects the mode of operation (AUTO, COOL, DRY, FAN, HEAT)   |
| ECO            | Activates/ deactivates the ECO function  |
|                | Hold for 3 seconds to activate/ deactivate the 46°F heating function   |
| TURBO          | Activates/ deactivates the TURBO function  |
| FAN            | Selects the fan speed: auto/ low/ low-mid/ mid/ mid-high/ high/ turbo  |
| TIMER          | Press to set the time for TIMER on/off.  |
| SLEEP          | Activates/ deactivates the SLEEP function  |
| DISPLAY        | Activates/ deactivates the LED display.  |
| SWING          | Activates/ deactivates vertical air flow SWING movement of the louvers or sets the desired up/ down air flow direction.      |
| SWING          | Activates/ deactivates horizontal air flow SWING movement of the louvers or sets the desired left/ right air flow direction. |
| I FEEL         | Activates/ deactivates the I FEEL function.  |
| MUTE           | Activates/ deactivates the MUTE function.  |
| MODE + TIMER   | Press both to activate/ deactivate LOCK function.  |
| SWING  + SWING | Press both to activate SELF-CLEAN function. It runs for ~30 minutes. Press the power button to deactivate if needed.         |

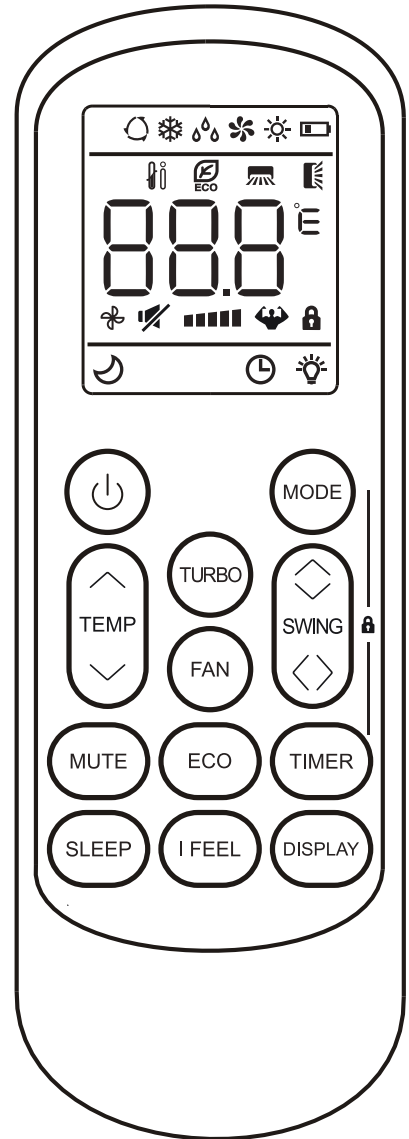

## REPLACING THE REMOTE BATTERIES

The remote uses two (2) AAA 1.5V batteries. To replace the batteries in your remote, do the following:

1. Remove the battery cover plate from the rear of the remote control by sliding it in the direction of the arrow.
2. Install the batteries according to the direction (+ and -) shown on the remote control.
3. Reinstall the battery cover by sliding it into place.

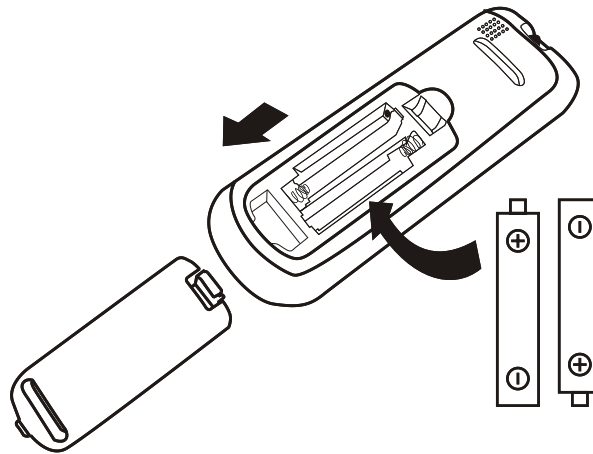

**CAUTION**

Do not use rechargeable batteries. Do not dispose of batteries with regular household waste. Batteries must be collected separately for proper treatment.



## OPERATING MODES ( )

### SETTING TEMPERATURE

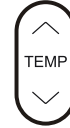

This unit can be set at any temperature within its operating range in AUTO, COOL, and HEAT modes (see "Temperature Ranges" section). You can increase or decrease the set temperature in 1°F (0.5°C) increments by pressing the TEMP UP (  ) or DOWN (  ) button.

Press and hold TURBO for 5 seconds to switch between °F and °C.





### AUTO ( )

In AUTO mode, the unit will automatically select the COOL or HEAT modes to maintain the set temperature.

To set the AUTO mode press  until the AUTO symbol (  ) appears at the top of the display.



### COOL ( )

In COOL mode, the unit will cool the room to the desired set temperature while reducing the air humidity at the same time.

To set the unit to COOL mode press  until the COOL symbol (  ) appears at the top of the display.



### DRY ( )

In DRY mode, the unit lowers room humidity for improved comfort. The function operates automatically, and the temperature cannot be adjusted.

To set the unit to DRY mode press  until the DRY symbol (  ) appears at the top of the display.



### FAN ( )

In FAN mode, the unit's fan is used to provide air circulation. The fan speed is controlled using the fan button as described on the next page. Temperature is not shown and cannot be adjusted.

To set the unit to FAN mode press  until the FAN symbol (  ) appears at the top of the display.

### HEAT ( )

In HEAT mode, the unit's heat pump technology is used to heat the room to the desired temperature.

To set the unit to HEAT mode press  until the HEAT symbol (  ) appears at the top of the display.

#### NOTE



In HEAT mode, the unit may run a 2–10 minute defrost cycle to remove condenser frost. The indoor fan stops during this process, then heating resumes automatically. If needed, press the ECO button 10 times within 8 seconds in HEAT mode to start forced defrosting.

## ADVANCED BUTTONS AND FUNCTIONS

### FAN SPEED BUTTON ( )

Press the FAN button to set the speed of the fan in AUTO, COOL, or HEAT modes. Pressing the fan button rotates through the following settings in the path illustrated below:

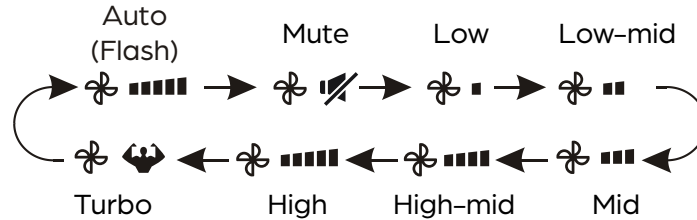

### LOCK ( )

The LOCK function disables all remote buttons to prevent changes to your settings. When active, no buttons will operate except the buttons that when pressed together unlock this function.

To activate hold + , to deactivate follow this same step.

### TIMER ( )

The TIMER function allows you to schedule when the unit turns itself on or off.

**TIMER ON** sets when the unit will turn on. Enable with the following steps:

1. Confirm that the unit is OFF and start by pressing the button.
2. The symbol will display and flash while the default setting of 6.0 hours shows on the screen.
3. Use the TEMP UP ( ) or DOWN ( ) button to set the desired time delay. The time changes by 0.5 between 0 and 10 hours and 1 between 10 and 24 hours.
4. Pressing the button again to confirm.
5. Press the button to select the operating mode the unit should start in.
6. Use the button to set the fan speed that the unit should operate with.
7. Use the TEMP UP ( ) or DOWN ( ) button to set the desired temperature.
8. The unit is now scheduled to start after the elapsed time.

**TIMER OFF** sets when the unit will turn off. Enable with the following steps:

1. Confirm that the unit is ON and start by pressing the button.
2. Use the TEMP UP ( ) or DOWN ( ) button to set the desired time delay. The time changes by 0.5 between 0 and 10 hours and 1 between 10 and 24 hours.
3. Pressing the button again to confirm. The symbol will show on the remote and unit.



#### NOTE

Press the TIMER button at any time during the steps above to cancel. If no buttons are pressed within 5 seconds, programming cancels and may need to be restarted.

## **SLEEP** ( )

The SLEEP function is designed to decrease energy use while you sleep. The SLEEP function is not available in FAN or DRY mode.

When you are ready to go to sleep select the  button and press OK. Press the button again to deactivate the function.

When in COOL mode, the unit will slowly increase the temperature over the first ~1-2 hours by up to 4°F (2°C). When in HEAT mode, the unit will decrease the temperature over the first ~1-2 hours by up to 4°F (2°C).

The SLEEP feature will turn off after ten (10) hours and the system will return to normal functioning.

## **I FEEL** ( )

This feature uses the temperature at the remote's location, instead of the indoor unit's location, to optimize the temperature around you and ensure maximum comfort.

To activate the I FEEL feature, press the  button and  will appear on the display. Press the button again to deactivate the function.

This feature will automatically deactivate after 8 hours (some models may be 2 hours).

## **ECO** ( )

In this mode, the appliance operates automatically to save energy. ECO is only available in COOL and HEAT modes.

To activate the ECO mode, press the  button and  will appear on the display. Press the button again to deactivate the function.

## **FREEZE PROTECTION**

This feature prevents indoor pipes and household items from freezing when the house is unoccupied for long periods of time in the winter.

Press and hold the  button for 3 seconds to set the indoor temperature to 46°F (8°C), and press the button again to deactivate it. The unit will return to standby once 48°F (9°C) is reached. The function automatically cancels once the outdoor temperature is 64°F (18°C).

## **DISPLAY**

This button turns the LED display on the indoor unit ON/OFF.

Press the  button and the LED on the unit will turn off. Press the button again to turn it on.



## **MUTE** ( )

In this mode, the appliance runs at its lowest indoor unit fan speed to minimize operational noise. The controller will display the AUTO fan speed and the  icon will appear on the display.

To activate the MUTE function, press the  button. Pressing FAN, TURBO or MUTE will deactivate the function.



## TURBO ( )

In COOL or HEAT mode, selecting TURBO activates rapid cooling or heating with maximum fan speed to reach the set temperature as quickly as possible.

To activate the TURBO mode, press the  button and  will appear on the display. Press the button again to deactivate the function.

## SELF-CLEAN

This function helps wash away dust, mold, and grease that may cause odors by freezing then rapidly thawing condensation on the indoor unit coil. We recommend activating it every 3 months.

To activate the function, turn OFF the indoor unit. Press the  and  button at the same time toward the unit until you hear a beep. "AC" will show on the remote control and the indoor unit display.

This function will run for about 30 minutes. When it is complete you will hear 2 beeps and the unit will return to the pre-set mode. You can press the power button to cancel this function during the process.



### NOTE

Some noise is normal during operation of this function, caused by plastic expanding with heat and contracting with cold.



### NOTE

Use this function only when the indoor temperature is less than 86°F (30°C) and the outdoor ambient temperature is between 41°F (5°C) and 86°F (30°C) to prevent safety shutdowns.

## SETTING AIR FLOW DIRECTION

The SWING button adjusts the louver direction and activates vertical and horizontal oscillation.

Press the  button to make the horizontal louvers swing up and down.  will appear on the remote.

Press again to stop the swing movement at the desired angle.

Press the  button to make the vertical louvers swing up and down.  will appear on the remote.

Press again to stop the swing movement at the desired angle.



### NOTE

Reminder, pressing the horizontal and vertical SWING buttons together activates the Self-Clean function described above.



### WARNING

Never adjust the flaps by hand, as this may damage the mechanism. Do not insert fingers or objects into the air vents—contact with moving or live parts can cause damage or injury.

## MANUAL OPERATION (USE WITHOUT REMOTE)

The manual override button is intended for testing purposes and emergency operation. Please do not use this button unless the remote control is lost and it is absolutely necessary. The unit must be turned off before manual operation, except to turn the unit off. (Always press the emergency button with an insulated material)

| Running Status | Instructions                          | Unit Response             | Enters Mode |
|----------------|---------------------------------------|---------------------------|-------------|
| Standby (Off)  | Press emergency button once           | Beeps briefly once        | COOL        |
| Standby (Off)  | Press emergency button twice in 3 sec | Beeps briefly twice       | HEAT        |
| Running        | Press emergency button once           | Keeps beeping for a while | OFF         |

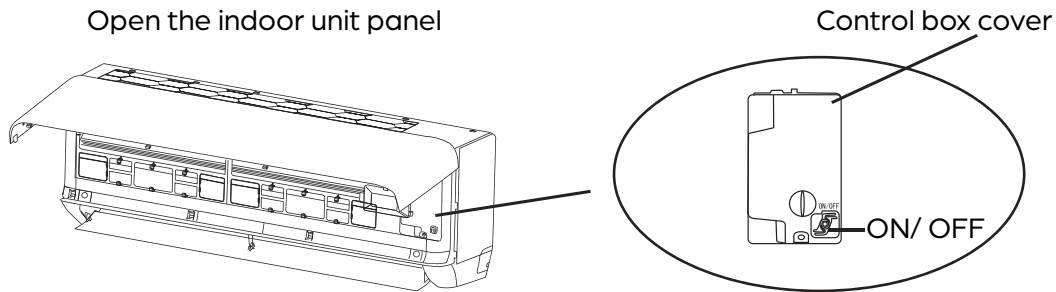

## CARE AND MAINTENANCE



### WARNING

- Always turn off the unit and disconnect power before cleaning or maintenance.
- Only use a soft, dry cloth to wipe the unit clean. If the unit is especially dirty, you can use a cloth soaked in warm water to wipe it clean.

### CLEANING INDOOR UNIT

- Do not use chemicals or chemically treated cloths to clean the unit.
- Do not use benzene, paint thinner, polishing powder or other solvents to clean the unit. They can cause the plastic surface to crack or deform.
- Do not use water hotter than 104°F (40°C) to clean the front panel. This can cause the panel to deform or become discolored.

## CLEANING THE AIR FILTER

A dirty air filter can reduce the cooling efficiency of your unit, and can also be bad for your health. Make sure to clean the filter once every two weeks.

1. Lift the front panel of the indoor unit.
2. First press the tab on the end of filter to loosen the buckle, lift it up, then pull it towards yourself
3. Now pull the filter out.
4. If your filter has a small air freshening filter, unclip it from the larger filter. Clean this air freshening filter with a hand-held vacuum.
5. Clean the large air filter with warm, soapy water. Be sure to use a mild detergent.
6. Rinse the filter with fresh water, then shake off excess water.
7. Dry filter in a cool, dry place, and refrain from exposing it to direct sunlight.
8. When dry, re-clip the air freshening filter to the larger filter, then slide it back into the indoor unit.
9. Close the front panel of the indoor unit.

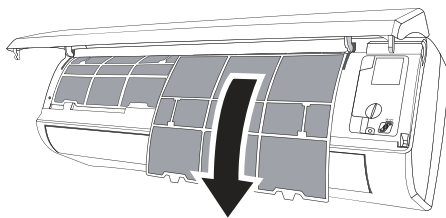

Remove the filter

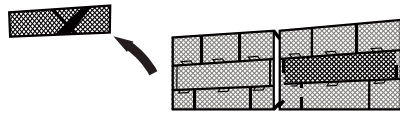

Remove accessory filter if applicable

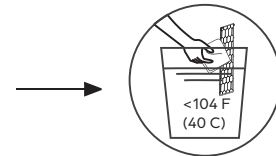

Clean the filter with soapy water and air dry it

### WARNING



- When removing the filter, do not touch the metal parts in the unit. The sharp metal edges can cut you.
- Do not use water to clean the inside of the indoor unit. This can destroy insulation and cause electrical shock.
- Do not expose filter to direct sunlight when drying. This can shrink the filter.

## MAINTENANCE: LONG PERIODS OF NON-USE

If you do not plan to use your air conditioner for an extended period of time, do the following:

- Clean all filters.
- Turn on the FAN until the unit dries out completely.
- Turn off the unit and disconnect the power.
- Remove batteries from remote control.

## MAINTENANCE: PRE-SEASON INSPECTION

After long periods of non-use, or before periods of frequent use, do the following:

- Inspect for damaged wires.
- Clean all filters.
- Check for leaks.
- Replace batteries.
- Make sure nothing is blocking any air inlets or outlets.

# TROUBLESHOOTING

## SAFETY PRECAUTIONS

If ANY of the following conditions occurs, turn off your unit immediately!

- The power cord is damaged or abnormally warm
- You smell a burning odor
- The unit emits loud or abnormal sounds
- A power fuse blows or the circuit breaker frequently trips
- Water or other objects fall into or out of the unit

DO NOT ATTEMPT TO FIX THESE YOURSELF! CONTACT AN AUTHORIZED SERVICE PROVIDER IMMEDIATELY!

## COMMON ISSUES

The following problems are not a malfunction and in most situations will not require repairs.

| ISSUE  | POSSIBLE CAUSES   |
|--|---|
| <b>Unit does not turn on when pressing ON/OFF button</b> | Verify that the unit has power.   |
|  | The unit has a protection feature that prevents the unit from overloading. The unit cannot be restarted within 2-5 minutes of being turned off.                                 |
|  | Verify that the TIMER-ON function is active.  |
| <b>The unit changes from COOL/HEAT mode to FAN mode</b>  | The unit may change its setting to prevent frost from forming on the unit. Once the temperature increases, the unit will start operating in the previously selected mode again. |
|  | The set temperature has been reached, at which point the unit turns off the compressor. The unit will continue operating when the temperature fluctuates again.                 |
| <b>The indoor unit emits white mist</b>                  | In humid regions, a large temperature difference between the room's air and the conditioned air can cause white mist.   |
| <b>Both the indoor and outdoor units emit white mist</b> | When the unit restarts in HEAT mode after defrosting, white mist may be emitted due to moisture generated during the defrosting process.  |
| <b>The indoor unit makes noises</b>                      | A rushing air sound may occur when the louver resets its position.  |
|  | A squeaking sound may occur after running the unit in HEAT mode due to expansion and contraction of the unit's plastic parts.   |
| <b>Both the indoor unit and outdoor unit make noises</b> | Low hissing sound during operation: This is normal and is caused by refrigerant gas flowing through both indoor and outdoor units.  |
|  | Low hissing sound when the system starts, has just stopped running, or is defrosting: This noise is normal and is caused by the refrigerant gas stopping or changing direction. |
|  | Squeaking sound: Normal expansion and contraction of plastic and metal parts caused by temperature changes during operation can cause squeaking noises.                         |

| ISSUE   | POSSIBLE CAUSES  |
|---|--|
| <b>The outdoor unit makes noises</b>  | The unit will make different sounds based on its current operating mode.   |
| <b>Dust is emitted from either the indoor or outdoor unit</b>                                   | The unit may accumulate dust during extended periods of non-use, which will be emitted when the unit is turned on. This can be mitigated by covering the unit during long periods of inactivity.   |
| <b>The unit emits a bad odor</b>  | The unit may absorb odors from the environment (such as furniture, cooking, cigarettes, etc.) which will be emitted during operations.   |
|   | The unit's filters have become moldy and should be cleaned.  |
| <b>The fan of the outdoor unit does not operate</b>   | During operation, the fan speed is controlled to optimize product operation.   |
| <b>Operation is erratic, unpredictable, or unit is unresponsive</b>                             | Interference from cell phone towers and remote boosters may cause the unit to malfunction. In this case, try the following: <ul style="list-style-type: none"> <li>• Disconnect the power, then reconnect.</li> <li>• Press ON/OFF button on remote control to restart operation.</li> </ul> |
| <b>The display is not showing.</b>  | Activate the DISPLAY function  |
|   | Verify that the unit has power.  |
| <b>Switch off the air conditioner immediately and cut off the power supply in the event of:</b> | Strange noises during operation.   |
|   | Faulty electronic control board  |
|   | Faulty fuses or switches   |
|   | Spraying water or objects inside the unit  |
|   | Overheated cables or plugs   |
|   | Very strong smells coming from the unit  |

## ADDITIONAL TROUBLESHOOTING

When troubles occur, check the following points. Contact a trained contractor to service the unit.

| PROBLEM                         | POSSIBLE CAUSES   | SOLUTION  |
|---------------------------------|---|---|
| <b>Poor Cooling Performance</b> | Temperature setting may be higher than ambient room temperature | Lower the temperature setting   |
|                                 | The heat exchanger on the indoor or outdoor unit is dirty       | Clean the affected heat exchanger   |
|                                 | The air filter is dirty   | Remove the filter and clean it according to instructions                  |
|                                 | The air inlet or outlet of either unit is blocked               | Turn the unit off, remove the obstruction and turn it back on             |
|                                 | Doors and windows are open                                      | Make sure that all doors and windows are closed while operating the unit  |
|                                 | Excessive heat is generated by sunlight                         | Close windows and curtains during periods of high heat or bright sunshine |
|                                 | Low refrigerant due to leak or long-term use                    | Check for leaks, re-seal if necessary and top off refrigerant             |

| PROBLEM  | POSSIBLE CAUSES   | SOLUTION  |
|--|---|---|
| <b>Poor Cooling Performance</b>                                | Excessive heat is generated by sunlight   | Block sunlight in installation area   |
|  | Too many sources of heat in the room (people, computers, electronics, etc.)   | Reduce amount of heat sources   |
| <b>Poor Heating Performance</b>                                | The outdoor temperature is extremely low  | This model is designed to work down to -13°F, however, heating performance is impacted at temperatures below freezing |
|  | Cold air is entering through doors and windows  | Make sure that all doors and windows are closed during use  |
|  | Low refrigerant due to leak or long-term use  | Check for leaks, re-seal if necessary, and top off refrigerant  |
| <b>The unit starts and stops frequently</b>                    | There's too much or too little refrigerant in the system  | Check for leaks and recharge the system with refrigerant  |
|  | Incompressible gas or moisture has entered the system   | Evacuate and recharge the system with refrigerant   |
|  | The voltage is too high or too low  | Install a manostat to regulate the voltage  |
| <b>The unit is not working</b>                                 | Power failure   | Wait for the power to be restored   |
|  | The power is turned off   | Turn on the power   |
|  | The fuse is burned out  | Replace the fuse  |
|  | Remote control batteries are dead   | Replace batteries   |
|  | Remote is not close enough to the unit.   | Stand closer to the unit.   |
|  | There are obstructions between the unit and the remote.   | Remove the obstructions   |
|  | The unit's 2-5 minute protection has been activated   | Wait 2-5 minutes after restarting the unit  |
|  | Timer is activated  | Turn timer off  |
| <b>Indicator lamps continue flashing or error code appears</b> | <p>The unit may stop operation or continue to run safely. If the indicator lamps continue to flash or error codes appear, wait for about 10 minutes. The problem may resolve itself.</p> <p>If not, disconnect the power, then connect it again. Turn the unit on.</p> <p>If the problem persists, disconnect the power and contact your nearest customer service center.</p> |   |



**NOTE**

If your problem persists after performing the checks and diagnostics above, turn off your unit immediately and contact an authorized service center.



**WARNING**

DO NOT ATTEMPT TO FIX THESE YOURSELF! CONTACT AN AUTHORIZED SERVICE PROVIDER! INJURY, DAMAGE TO THE EQUIPMENT AND/OR VOIDING THE WARRANTY COULD OCCUR.

## LIMITED WARRANTY – PARTS

This Limited Warranty applies to Covered Equipment manufactured on or after November 1<sup>st</sup>, 2024.

COVERED EQUIPMENT is defined by the following model number categories:

DRA1\_S2A, DRA3\_M2A, DRA4\_M2A, DRA5\_M2A, DRA6\_M2A, DRU1\_S2A, DRE1\_S2A, DREW\_S2AL, DRAC\_F2A, DRAD\_F2A, DRAF\_F2A, DRAL\_F2A, DRAM\_F2A, DRAS\_F2A, DRAW\_F2A, DRUM\_S2A.

Durastar accessories installed with Covered Equipment carry the balance of the Covered Equipment warranty.

### BASE RESIDENTIAL WARRANTY: SEVEN (7) YEARS PARTS

Subject to the terms of this Limited Warranty, Manufacturer will repair or replace, at its option, any part of the Covered Equipment that is found to be defective in material or workmanship.

Covered Equipment Parts are warranted to be free from defects in material and workmanship for a period of seven (7) years from the date of installation, under normal use and service. Durastar will, at its option, repair or replace any part determined by Durastar to be defective. Replacement parts carry the balance of the original parts warranty. If an exact replacement part is not available, an equivalent part or credit will be provided.

To qualify:

- The Covered Equipment must be installed in a residential single-family home.\*
- The Covered Equipment must be properly installed by a licensed HVAC professional pursuant to all local and state laws.
- Any part to be replaced must be made available to Durastar in exchange for the replacement.

\*Single-family home is defined as any single-family dwelling, which includes apartments, condominiums, duplexes, and homes.

### BASE COMMERCIAL WARRANTY: TWO (2) YEAR PARTS

Subject to the terms of this Limited Warranty, Covered Equipment installed in commercial applications are warranted against defects in material and workmanship for a period of TWO (2) YEARS.

### REGISTERED WARRANTY

Parts for Covered Equipment that is registered by the purchaser online within ninety (90) days of the original installation date shall be warranted for an extended period subject to the terms in this Limited Warranty. Any Covered Equipment not properly registered within the ninety (90) day registration window will be subject to the base warranty terms outlined herein. To register your Covered Equipment online, go to: [www.durastar.com/warranty-registration](http://www.durastar.com/warranty-registration)

Registered Residential Warranty: TEN (10) years

Registered Commercial Warranty: FIVE (5) years

FLORIDA, TEXAS, AND CALIFORNIA RESIDENTS ONLY: Failure to register Covered Equipment does not diminish or decrease your limited warranty length. Covered Equipment will receive the full REGISTERED WARRANTY terms.

### EFFECTIVE DATE OF WARRANTY

The Effective Date of warranty coverage is determined as follows: (a) If the original installation date can be verified by the installer's invoice then the Effective Date of warranty coverage is the original installation date as shown on the installer's invoice. For residential new construction installations, the final occupancy permit, or proof of purchase from the builder can be substituted for the installer's invoice. (b) if the original installation date cannot be verified by the installer's invoice, or proof of purchase from the builder in residential new construction applications, then the Effective Date of warranty coverage is the Covered Equipment's manufacture date (as verified by the product's serial number) plus ninety (90) days.

### LIMITATIONS

There is NO LABOR component provided with this warranty. This Limited Warranty does NOT cover any labor costs or expenses for service, NOR for removing or reinstalling parts.

This Limited Warranty does NOT cover shipping costs for warranty replacement parts from our factory to the Manufacturer's distributor or from the distributor to the location of your Covered Equipment. You also are responsible for the cost of shipping allegedly defective parts to the distributor and for incidental costs incurred locally, including handling charges. (If in Alaska, Hawaii or Canada, you also must pay the shipping costs of returning the failed part to the port of entry into the continental United States.)

Manufacturer's Liability hereunder is limited to the repair or replacement of Covered Equipment Parts, and in no event shall exceed the value of the original Covered Equipment Purchase Price. Liability for incidental, consequential or special damages are specifically excluded.

#### EXCLUSIONS

In addition to the other exclusions identified in this Limited Warranty, this Limited Warranty excludes:

- Damages, malfunctions, or failures resulting from failure to properly install, operate, or maintain Covered Equipment in accordance with the Manufacturer's instructions.
- Damages, malfunctions, or failures resulting from misuse, accident, contaminated/ corrosive atmosphere, vandalism, freight damage, fire, flood, freeze, lightning, power surges, acts of war, acts of God and the like.
- Non-original parts installed with Covered Equipment or used in connection with normal maintenance, such as cleaning or replacing air filters, refrigerant, thermostats, tubing, or concrete pads.
- Covered Equipment that is not installed in the United States.
- Covered Equipment that is not installed by a qualified, trained or licensed HVAC professional in accordance with applicable codes, ordinances, and good trade practices.
- Damages, malfunctions, or failures resulting from the use of any attachment, accessory, or component not authorized by the Manufacturer or resulting from alteration or modification of the unit.
- Covered Equipment moved from the original installation location.
- Covered Equipment when operated with system components (indoor unit, outdoor unit, coil, and refrigerant control devices) or accessories which do not match or meet the specifications recommended by the Manufacturer.
- Any Covered Equipment manufactured that has been sold to the consumer via the Internet or auction website, and has not been installed by a trained, qualified HVAC professional.
- Covered Equipment that is not part of a properly matched system as specified by the Air Conditioning, Heating & Refrigeration Institute (AHRI).

#### OBTAINING WARRANTY SERVICE

If you believe your Covered Equipment is defective, contact the licensed contractor who installed your mini-split system. Alternatively, contact a licensed contractor, dealer, or distributor.

Durastar Customer Support is available for troubleshooting assistance. Before contacting Customer Support, please locate your model number, serial number, and proof of purchase. These items will be required to complete any warranty service. A Durastar authorized representative will verify warranty eligibility and determine appropriate service options. Service will be provided during normal business hours.

The warranty claim must be submitted at [www.durastar.com/warranty-claim](http://www.durastar.com/warranty-claim) by the servicing contractor within 90 DAYS after the date of service in order for the warranty to be approved. The service invoice and/or return of parts may be requested to verify eligibility.

THIS WARRANTY IS IN LIEU OF ANY OTHER WARRANTY, EXPRESS OR IMPLIED, INCLUDING WITHOUT LIMITATION, ANY WARRANTY OF MERCHANTABILITY OR FITNESS FOR A PARTICULAR PURPOSE. TO THE EXTENT ANY IMPLIED WARRANTY IS REQUIRED BY LAW, IT IS LIMITED IN DURATION TO THE EXPRESS WARRANTY PERIOD ABOVE. NEITHER THE MANUFACTURER NOR ITS DISTRIBUTORS SHALL BE LIABLE FOR ANY INCIDENTAL, CONSEQUENTIAL, INDIRECT, SPECIAL, OR PUNITIVE DAMAGES OF ANY NATURE, INCLUDING WITHOUT LIMITATION, LOST REVENUES OR PROFITS, OR ANY OTHER DAMAGE WHETHER BASED IN CONTRACT, TORT, OR OTHERWISE. IN NO EVENT AND UNDER NO CIRCUMSTANCE OF ANY TYPE OR KIND SHALL THE SELLER, MANUFACTURER AND/OR DISTRIBUTOR BE LIABLE FOR ANY REASON, UNDER ANY THEORY, FOR MORE THAN THE BASIC COST OF THE PRODUCT TO THE PURCHASER OR END USER. SOME STATES DO NOT ALLOW THE EXCLUSION OF INCIDENTAL OR CONSEQUENTIAL DAMAGES, SO THE ABOVE EXCLUSION MAY NOT APPLY TO YOU. THIS WARRANTY GIVES YOU SPECIFIC LEGAL RIGHTS. YOU MAY HAVE OTHER RIGHTS THAT VARY FROM STATE TO STATE.

**THIS PAGE INTENTIONALLY LEFT BLANK.**



**THIS PAGE INTENTIONALLY LEFT BLANK.**

