

FRIGIDAIRE

All about the

Use & Care

of your Refrigerator

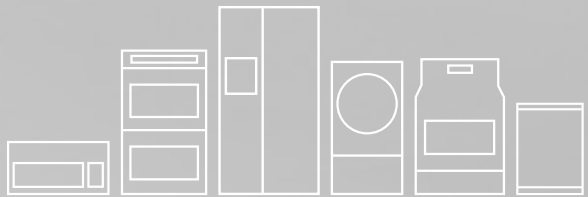

TABLE OF CONTENTS

Important Safety Instructions.....	2	Storage Features.....	20
Features At A Glance - Baseline Model	4	Automatic Ice & Water Dispenser - Frigidaire Gallery (some models)	21
Features At A Glance - Gallery/Pro Model	5	Automatic Ice & Water Dispenser - Frigidaire Gallery/Pro (some models)	24
Installation	6	Changing the Filter - Frigidaire Gallery	27
Door Removal Instructions	8	Changing the Filter - Frigidaire Pro	29
Handle Installation	10	Normal Operating Sounds and Sights.....	30
Connecting the Water Supply	11	Care & Cleaning	31
Controls - Frigidaire Gallery.....	13	Before You Call	35
Controls - Frigidaire & Frigidaire Gallery	16	Major Appliance Warranty	40
Controls - Frigidaire Professional	17		

IMPORTANT SAFETY INSTRUCTIONS



WARNING

Please read all instructions before using this refrigerator.

For your Safety

- DO NOT store or use gasoline, or other flammable liquids in the vicinity of this or any other appliance. Read product labels for warnings regarding flammability and other hazards.
- DO NOT operate the refrigerator in the presence of explosive fumes.
- Avoid contact with any moving parts of automatic ice maker.
- Remove all staples from the carton. Staples can cause severe cuts, and also destroy finishes if they come in contact with other appliances or furniture.

Definitions

 This is the safety alert symbol. It is used to alert you to potential personal injury hazards. Obey all safety messages that follow this symbol to avoid possible injury or death.



DANGER

DANGER indicates an imminently hazardous situation which, if not avoided, will result in death or serious injury.



WARNING

WARNING indicates a potentially hazardous situation which, if not avoided, could result in death or serious injury.



CAUTION

CAUTION indicates a potentially hazardous situation which, if not avoided, may result in minor or moderate injury.



IMPORTANT

IMPORTANT indicates installation, operation or maintenance information which is important but not hazard-related.



Installation Checklist

Doors

- Handles are secure and tight
- Door seals completely to cabinet on all sides
- Freezer door is level across the top

Leveling

- Refrigerator is level, side-to-side and tilted $\frac{1}{4}$ " (6mm) front-to-back
- Toe grille is properly attached to refrigerator
- Cabinet is setting solid on all corners

Electrical Power

- House power turned on
- Refrigerator plugged in

Ice Maker

- House water supply connected to refrigerator
- No water leaks present at all connections - recheck in 24 hours
- Ice maker is turned ON
- Ice & water dispenser operates correctly
- Front filter must be flush with filter housing (select models)

Final Checks

- Shipping material removed
- Fresh food and freezer temperatures set
- Crisper humidity controls set
- Registration card sent in

Child Safety

Destroy or recycle the carton, plastic bags, and any exterior wrapping material immediately after the refrigerator is unpacked. Children should **NEVER** use these items to play. Cartons covered with rugs, bedspreads, plastic sheets or stretch wrap may become airtight chambers, and can quickly cause suffocation.

Proper Disposal of your Refrigerator or Freezer

Risk of child entrapment

Child entrapment and suffocation are not problems of the past. Junked or abandoned refrigerators or freezers are still dangerous – even if they will sit for “just a few days”. If

IMPORTANT SAFETY INSTRUCTIONS

you are getting rid of your old refrigerator or freezer, please follow the instructions below to help prevent accidents.

Proper Disposal of Refrigerators/Freezers

We strongly encourage responsible appliance recycling/disposal methods. Check with your utility company or visit www.energystar.gov/recycle for more information on recycling your old refrigerator.

Before you throw away your old refrigerator/freezer:

- Remove doors.
- Leave shelves in place so children may not easily climb inside.
- Have refrigerator removed by a qualified service technician.

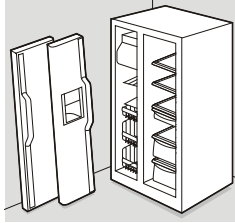

refrigerator to a Ground Fault Interrupter (GFI) circuit. **Do not use an extension cord or adapter plug.**

- If the power cord is damaged, it should be replaced by an authorized service technician to prevent any risk.
- Never unplug the refrigerator by pulling on the power cord. Always grip the plug firmly, and pull straight out from the receptacle to prevent damaging the power cord.
- Unplug the refrigerator before cleaning and before replacing a light bulb to avoid electrical shock.
- Performance may be affected if the voltage varies by 10% or more. Operating the refrigerator with insufficient power can damage the compressor. Such damage is not covered under your warranty.
- Do not plug the unit into an electrical outlet controlled by a wall switch or pull cord to prevent the refrigerator from being turned off accidentally.



IMPORTANT

CFC/HCFC Disposal

Your old refrigerator may have a cooling system that used CFCs or HCFCs (chlorofluorocarbons or hydrochlorofluorocarbons). CFCs and HCFCs are believed to harm stratospheric ozone if released to the atmosphere. Other refrigerants may also cause harm to the environment if released to the atmosphere.

If you are throwing away your old refrigerator, make sure the refrigerant is removed for proper disposal by a qualified technician. If you intentionally release refrigerant, you may be subject to fines and imprisonment under provisions of environmental legislation.



IMPORTANT

Pressing and holding the **On/Off** button for three seconds, located on the temperature control panel (Electronic controls), or turning the Freezer and Fresh Food controls to "0" (Mechanical controls) will disable your refrigerator's cooling system, but does not disconnect the power to the lighting system and other electrical components. To turn off power to your refrigerator you must unplug the power cord from the electrical outlet.



WARNING

These guidelines must be followed to ensure that safety mechanisms in this refrigerator will operate properly.

Grounding type wall receptacle

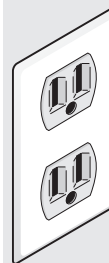

Do not, under any circumstances, cut, remove, or bypass the grounding prong.

Power cord with 3-prong grounded plug



Electrical information

- **The refrigerator must be plugged into its own dedicated 115 Volt, 60 Hz., 15 Amp, AC only electrical outlet.** The power cord of the appliance is equipped with a three-prong grounding plug for your protection against electrical shock hazards. It must be plugged directly into a properly grounded three prong receptacle. The receptacle must be installed in accordance with local codes and ordinances. Consult a qualified electrician. Avoid connecting



CAUTION

To avoid personal injury or property damage, handle tempered glass shelves carefully. Shelves may break suddenly if nicked, scratched, or exposed to sudden temperature change.

FEATURES AT A GLANCE - BASELINE MODEL

Features may vary according to model

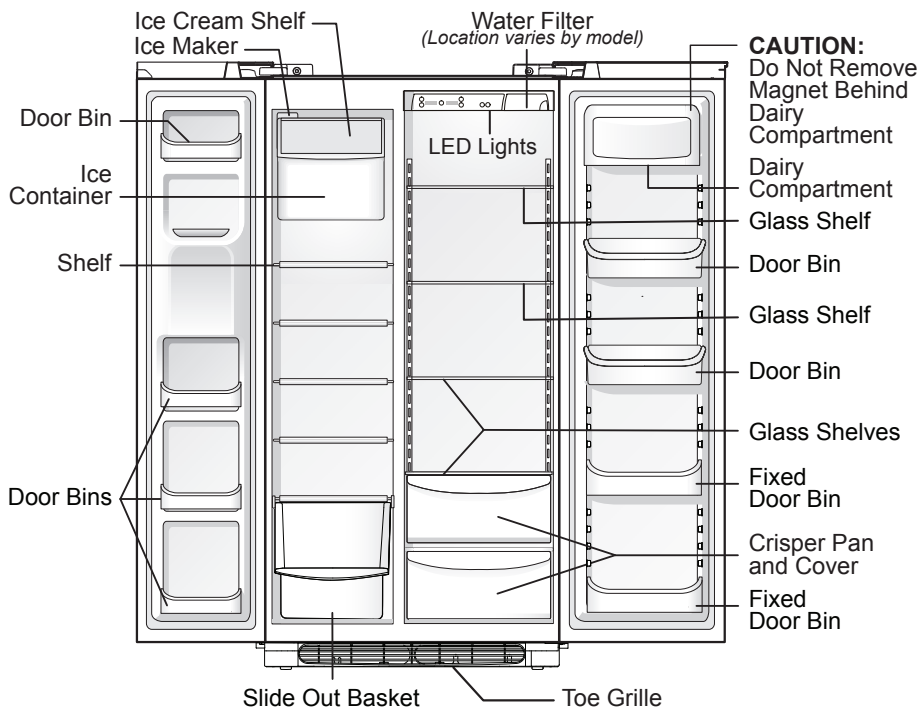

IMPORTANT

Features not included with your refrigerator can be purchased at www.frigidaire.com or by calling 1-800-374-4432.

FEATURES AT A GLANCE - GALLERY/PRO MODEL

Features may vary according to model

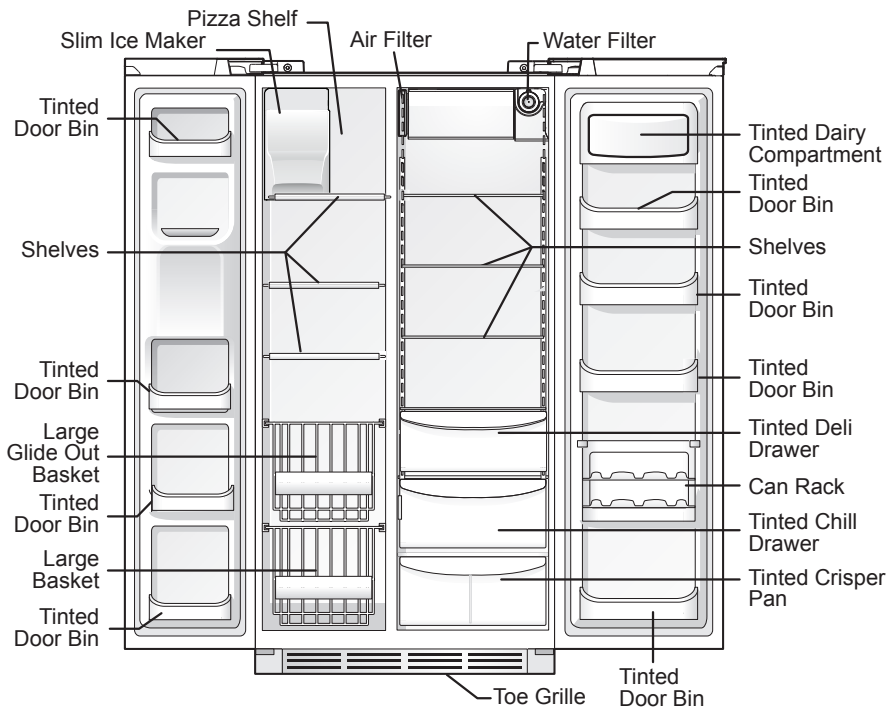

IMPORTANT

Features not included with your refrigerator can be purchased at www.frigidaire.com or by calling 1-800-374-4432.

INSTALLATION

This Use & Care Guide provides general operating instructions for your model. Use the refrigerator only as instructed in this Use & Care Guide. **Before starting the refrigerator, follow these important first steps.**

Location

- Choose a place that is near a grounded electrical outlet. **Do Not** use an extension cord or an adapter plug.
- If possible, place the refrigerator out of direct sunlight and away from the range, dishwasher or other heat sources.
- The refrigerator must be installed on a floor that is level and strong enough to support a fully loaded refrigerator.
- Consider water supply availability for models equipped with an automatic ice maker. If you do not hook up water to the refrigerator, remember to turn the ice maker off.



CAUTION

Do Not install the refrigerator where the temperature will drop below 55°F (13°C) or rise above 110°F (43°C). The compressor will not be able to maintain proper temperatures inside the refrigerator.

Do Not block the toe grille on the lower front of your refrigerator. Sufficient air circulation is essential for the proper operation of your refrigerator.

Installation

Installation clearances

Allow the following clearances for ease of installation, proper air circulation, and plumbing and electrical connections:

Sides & Top	$\frac{3}{8}$ inch
Back	1 inch

NOTE

If your refrigerator is placed with the door hinge side against a wall, you may have to allow additional space so the door can be opened wider.

Toe Grille Installation and Removal

To install toe grille

1. Open both doors. Slide left and right sides of toe grille over lower hinges of refrigerator.
2. While pushing toe grille firmly against cabinet, fasten bottom clips of toe grille to cabinet.
3. Fasten top clips to cabinet.
4. Close the doors. Fasten right and left side clips into groove of bottom hinge.



To remove toe grille

1. With both doors closed, unfasten right and left side clips of toe grille from bottom hinge groove.
2. Open both doors. Press firmly on top of toe grille until top of toe grille pops off.
3. Pull toe grille outward toward your body and off of lower hinges.

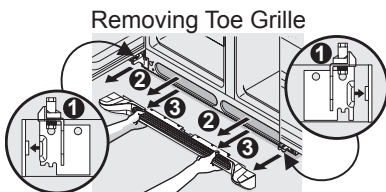

Door Opening

NOTE

The refrigerator doors are designed to shut by themselves within a 20 degree opening.

Your refrigerator should be positioned to allow easy access to a counter or table when removing food. For best use of drawers and freezer baskets, the refrigerator should be in a position where both the refrigerator and freezer doors can be fully opened.

Guidelines for final positioning of your refrigerator:

- All four corners of the cabinet must rest firmly on the floor.
- The cabinet should be level at the front and rear.
- The sides should tilt $\frac{1}{4}$ inch (6 mm) from front to back (to ensure that doors close and seal properly).
- Doors should align with each other and be level.

All of these conditions can be met by raising or lowering the adjustable front rollers.

To level the cabinet using the front rollers:

1. Open both doors and remove the toe grille (see "**Toe Grille Installation and Removal**" in the "**Installation**" section).
2. Close the doors and use a flat-blade screwdriver or $\frac{3}{8}$ inch socket wrench to raise or lower the front rollers.
3. Ensure both doors are bind-free with their seals touching the cabinet on all 4 sides.

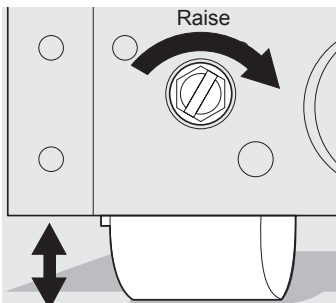

To level the doors using the adjustable lower hinge (some models):

1. Before leveling either door, remove set screw that locks door height into position. (The door cannot be adjusted without set screw removed).
2. If the refrigerator door is lower than the freezer door, raise the refrigerator door by turning the adjustment screw clockwise using a $\frac{7}{16}$ inch wrench. (See illustration.)
3. If the freezer door is lower than the refrigerator door, raise the freezer door by turning the adjustment screw clockwise using a $\frac{7}{16}$ inch wrench. (See illustration.)

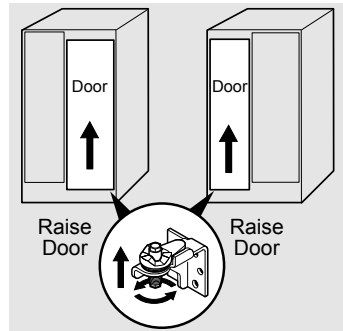

4. After leveling, verify door stop contacts lower hinge and top of door does not contact upper hinge through full movement of door (from fully closed to fully open).
5. Reinstall set screw, locking the door height.

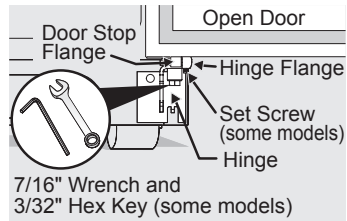

6. Replace the toe grille by fitting it into place (see "**Toe Grille Installation and Removal**" in the "**Installation**" section).

DOOR REMOVAL INSTRUCTIONS

Tools Necessary:

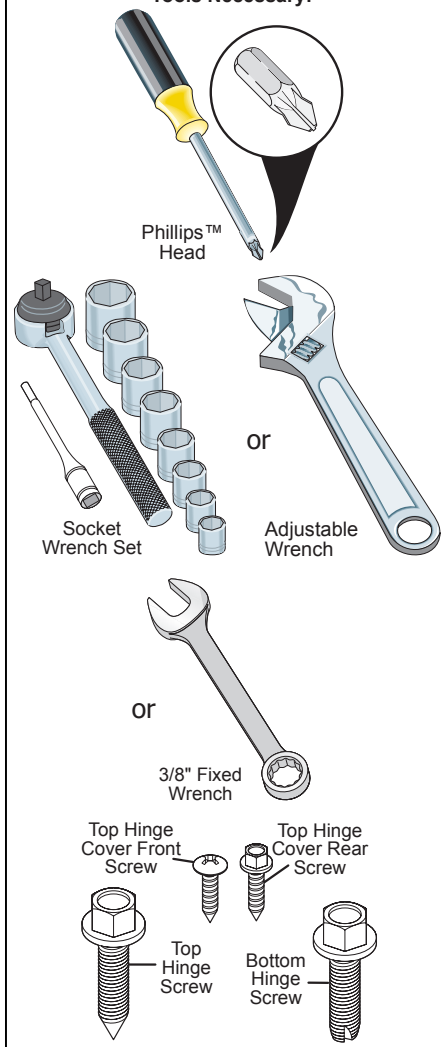

To prepare for removing the doors:

1. Make sure the electrical power cord is unplugged from the wall outlet.
2. Open both doors and remove the toe grille (as explained in the Installation Instructions that came with your appliance).
3. Remove any food from the door shelves.
4. Close the doors.

To remove the refrigerator top hinge cover:

5. Remove the 3 screws from each cover over the top door hinges.
6. Lift hinge cover straight up and off.

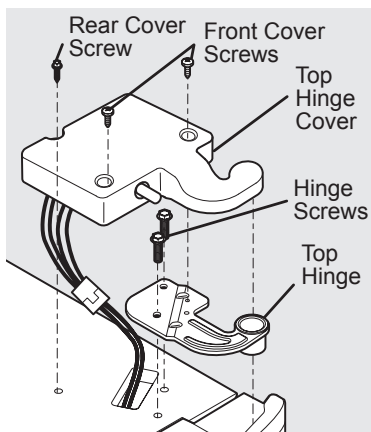

To remove the refrigerator door:

1. Trace lightly around the door's top hinge with a pencil. This makes reinstallation easier.

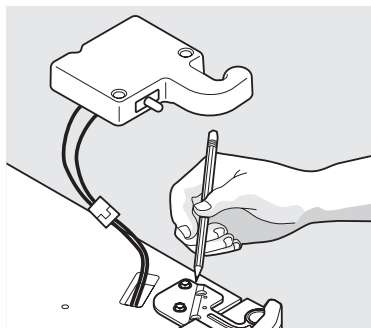

2. Remove the 2 screws from the top hinge. Lift the door off of the bottom hinge and set it aside.

DOOR REMOVAL INSTRUCTIONS

1. Remove the 2 bottom hinge screws and hinge if necessary.

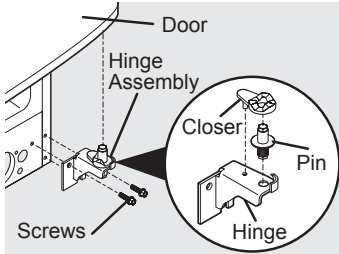

Adjustable Hinge (some models)

To reinstall the refrigerator door, reverse the above steps.

To remove the freezer top hinge cover:

1. Remove the 2 screws from each cover over the top door hinges.
2. Lift hinge cover straight up and off.

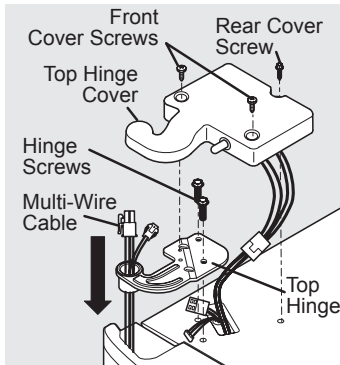

To remove the freezer door:

1. Detach the multi-wire cable connector located above the top hinge. Grasp both sides of the connector firmly and pull apart.

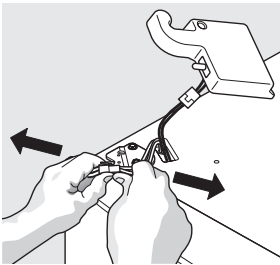

2. Trace lightly around the hinge with a pencil. This makes reinstallation easier.
3. Detach the water tube from the connector located below the freezer door. The connector releases when you press its outer sleeve inward.

4. Remove the screws from the top hinge and pull the multi-wire cable through it. Lift the door off of the bottom hinge.
5. Remove the 2 bottom hinge screws and hinge if necessary.

To Disconnect

1. Press outer ring against face of fitting
2. Pull to remove tube

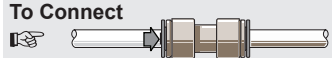

To Connect

Insert tube and push until mark touches face of fitting

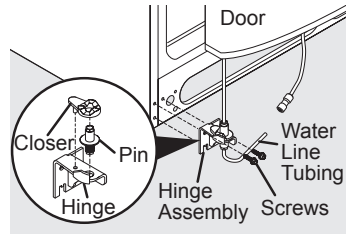

Adjustable Hinge (some models)

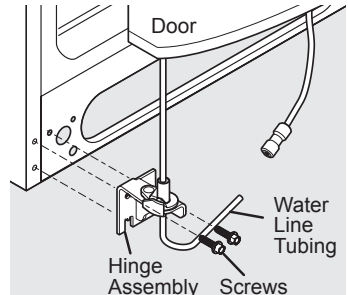

Non-Adjusting Hinge (some models)

6. Lay the door on its side to avoid damage to the water tube extending from the bottom hinge.

To reinstall the freezer door, reverse the above steps.



CAUTION

Be sure doors are set aside in a secure position where they cannot fall and cause personal injury.

HANDLE INSTALLATION



CAUTION

Wear gloves and safety goggles and use extreme CAUTION when installing these handles. The rounded end of the handles may be sharp (some models).



IMPORTANT

To ensure proper installation of handles, please review these instructions and illustrations thoroughly prior to installing the handles.

1. Remove handles from protective packaging.
2. Position freezer handle end caps over upper and lower pre-installed shoulder bolts (A) that are fastened into door, ensuring the holes for the set screws are facing towards the refrigerator door.
3. While holding handle firmly against door, fasten furthestmost upper and furthestmost lower Allen set screws (B) with supplied Allen wrench.
4. Firmly tighten the inside Allen set screws.
5. Repeat steps 2 through 4 to install refrigerator handle. Ensure the holes for the set screws are facing towards the freezer door.

NOTE

All set screws should be tightened and sub-flush (Allen set screw should be seated just below the surface of the end cap) of handle end cap. The end caps should be drawn tight to freezer and refrigerator doors with no gaps.

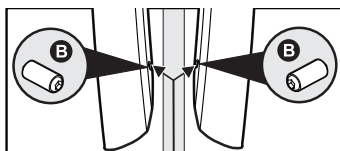

Ensure Handle Set Screws are Facing Each Other with Doors Closed

Frigidaire Professional®

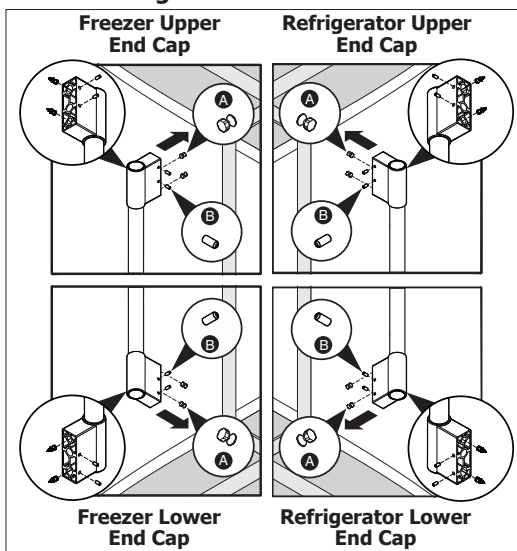

Frigidaire Gallery®

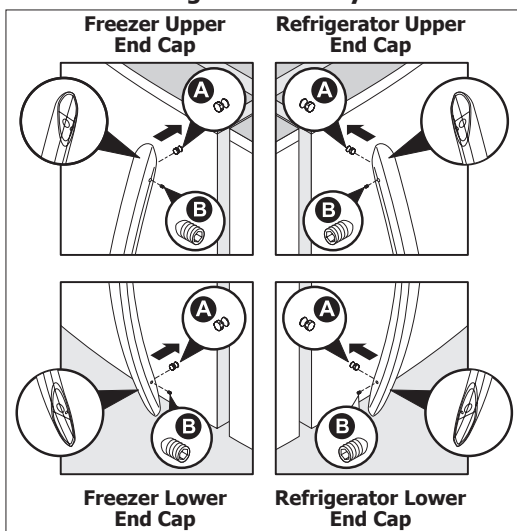

CONNECTING THE WATER SUPPLY



WARNING

To avoid electric shock, which can cause death or severe personal injury, disconnect the refrigerator from electrical power before connecting a water supply line to the refrigerator.



CAUTION

To Avoid Property Damage:

- Copper or Stainless Steel braided tubing is recommended for the water supply line. Water supply tubing made of ¼ inch plastic is not recommended to be used. Plastic tubing greatly increases the potential for water leaks, and the manufacturer will not be responsible for any damage if plastic tubing is used for the supply line.
- DO NOT install water supply tubing in areas where temperatures fall below freezing.
- Chemicals from a malfunctioning softener can damage the ice maker. If the ice maker is connected to soft water, ensure that the softener is maintained and working properly.



IMPORTANT

Ensure that your water supply line connections comply with all local plumbing codes.

Before Installing The Water Supply Line, You Will Need:

- Basic Tools: adjustable wrench, flat-blade screwdriver, and Phillips™ screwdriver
- Access to a household cold water line with water pressure between 30 and 100 psi.
- A water supply line made of ¼ inch (6.4 mm) OD, copper or stainless steel tubing. To determine the length of tubing needed, measure the distance from the ice maker inlet valve at the back of the refrigerator to your cold water pipe. Then add approximately 7 feet (2.1 meters), so the refrigerator can be moved out for cleaning (as shown).
- A shutoff valve to connect the water supply line to your household water system. Do not use a self-piercing type shutoff valve.
- Do not reuse compression fitting or use thread seal tape.

- A compression nut and ferrule (sleeve) for connecting a copper water supply line to the ice maker inlet valve.



NOTE

Check with your local building authority for recommendations on water lines and associated materials prior to installing your new refrigerator. Depending on your local/state building codes, Frigidaire recommends for homes with existing valves its **Smart Choice®** water line kit 5304490728 (with a 6 ft. Stainless Steel Water Line) or 5304493869 (with a 6 ft. Polyline Water Line) and for homes without an existing valve, Frigidaire recommends its **Smart Choice®** water line kit 5304490717 (with a 20 ft. copper water line with self-tapping saddle valve). Please refer to www.frigidaire.com/store for more information.

To Connect Water Supply Line To Ice Maker Inlet Valve

1. Disconnect refrigerator from electric power source.
2. Place end of water supply line into sink or bucket. Turn ON water supply and flush supply line until water is clear. Turn OFF water supply at shutoff valve.
3. Remove plastic cap from water valve inlet and discard cap.
4. **If you use copper tubing** - Slide brass compression nut, then ferrule (sleeve) onto water supply line. Push water supply line into water valve inlet as far as it will go (¼ inch/6.4 mm). Slide ferrule (sleeve) into valve inlet and finger tighten compression nut onto valve. Tighten another half turn with a wrench; DO NOT overtighten. See Figure 1.

If you use braided flexible stainless steel or polyline tubing - The nut is already assembled on the tubing. Slide nut onto valve inlet and finger tighten nut onto valve. Tighten another half turn with a wrench; DO NOT overtighten. See Figure 2.

CONNECTING THE WATER SUPPLY

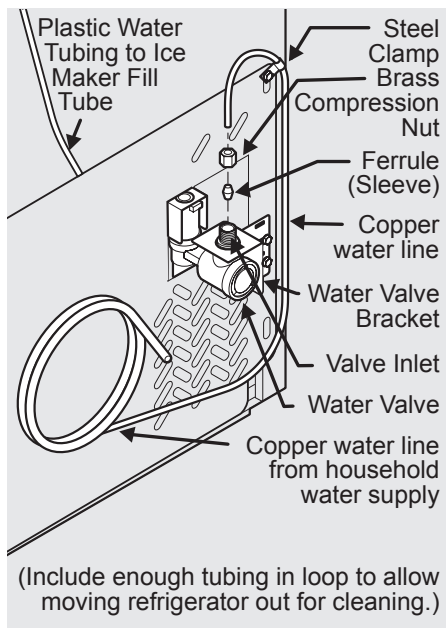

Figure 1

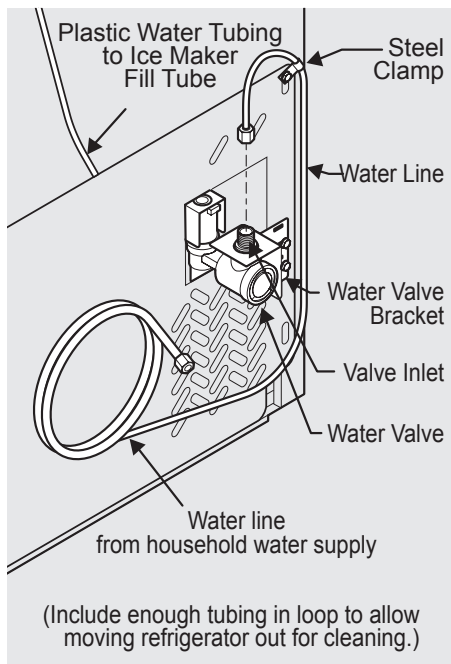

Figure 2

5. With steel clamp and screw, secure water supply line (copper tubing only) to rear panel of refrigerator as shown.
6. Coil excess water supply line (copper tubing only), about 2½ turns, behind refrigerator as shown and arrange coils so they do not vibrate or wear against any other surface.
7. Turn ON water supply at shutoff valve and tighten any connections that leak.
8. Reconnect refrigerator to electrical power source.
9. To turn ice maker on, lower wire signal arm (side mounted) or set the ice maker's On/Off power switch to the "I" position (rear mounted).



IMPORTANT

After connecting the water supply, refer to "How to Prime the Water Supply System" for important information about priming an empty water supply system.

To ensure that your water dispenser works properly, the water supply system must be completely filled with water when your refrigerator is first connected to the household water supply line.

CONTROLS - FRIGIDAIRE GALLERY

User Interface (varies by model)

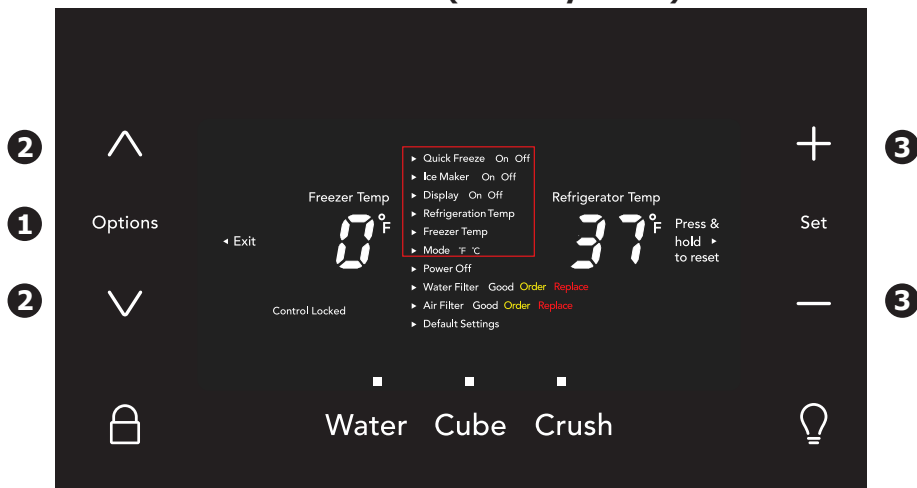

Operating the Controls

- 1 Press **Options** key
- 2 Use **Arrow** keys \wedge/\vee to scroll the menu selections
- 3 Use the **+** or **-** keys to change the option from on/off/change temperature or mode °F/°C
- 1 Use the **Options** key to exit and save changes

NOTE

The recommended settings for a product installed in a kitchen is 37°F for the fresh food compartment and 0°F for the freezer.

Quick Freeze On Off	Activates a faster rate for freezing food. Deactivates after 12 hours.
Ice Maker On Off	Press and hold for three seconds to toggle the ice maker in the freezer compartment "on" and "off".
Display On Off	Toggles the temperature displays On and Off.
Refrigeration Temp	Allows the temperature set points to be adjusted. Control temperatures range from +33°F / +1°C to +47°F / +8°C.
Freezer Temp	Allows the temperature set-points to be adjusted. Control temperatures range from -6°F / -21°C to +6°F / -15°C.
Mode °F °C	Toggles display from Fahrenheit to Celsius.

CONTROLS - FRIGIDAIRE GALLERY

User Interface (varies by model)

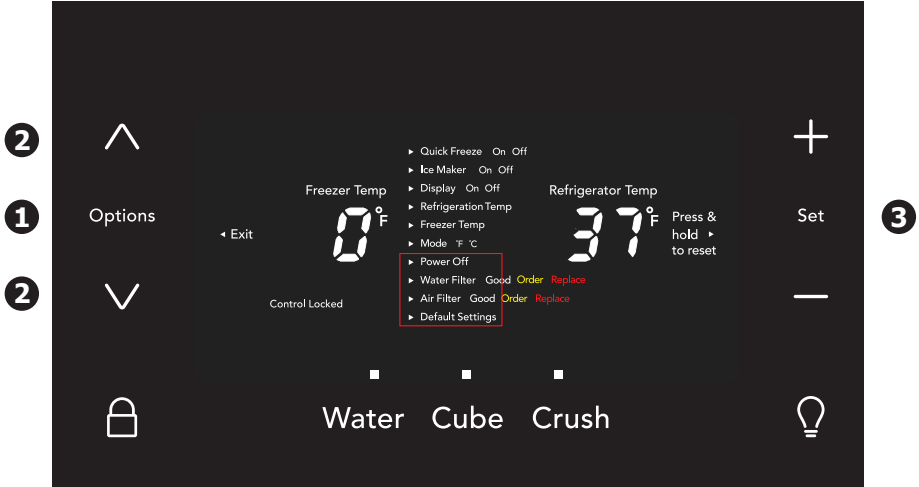

Operating the Controls

- 1 Press **Options** key
- 2 Use **Arrow** keys ^/v to scroll the menu selections
- 3 Press and hold **Set** key for 3 seconds
- 1 Use the **Options** key to exit and save changes

power off	Press and hold Set for 3 seconds to turn off the cooling system. It also turns off the ice maker and all dispenser functions. The display will read power off . Press and hold Set to turn power on.
water filter	Displays the current status of the water filter (Good , Order , or Replace). To reset the filter status to Good , press and hold the Set key for 3 seconds.
air filter	Displays the current status of the air filter (Good , Order , or Replace). To reset the filter status to Good , press and hold the Set key for 3 seconds.
default settings	While in the default option, press and hold the Set key for 3 seconds to reset all refrigerator settings to their factory default settings.



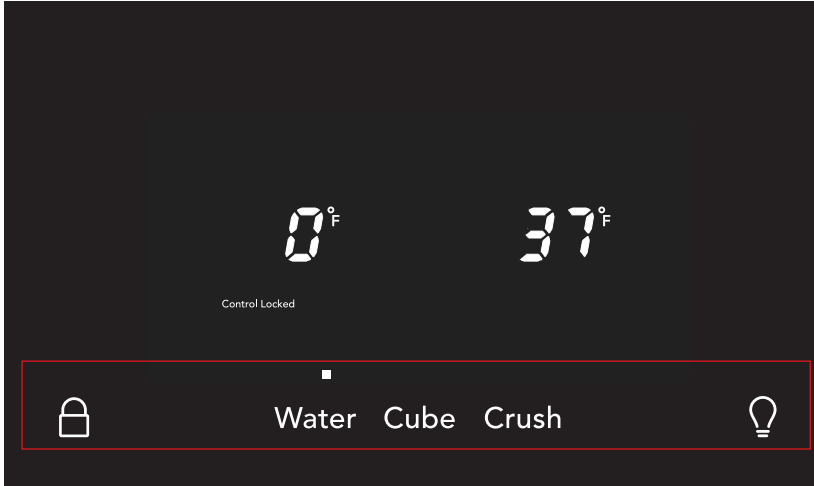

CONTROLS - FRIGIDAIRE GALLERY

User Interface (varies by model)



Operating the Controls

To activate features press the corresponding icon key on the display

water		Press the Water key to select water. Indicator light will be illuminated above the active feature.
cube		Press the Cube key to select cubed ice. Indicator light will be illuminated above the active feature.
crush		Press the Crush key to select crushed ice. Indicator light will be illuminated above the active feature.
control locked		Press and hold  for 3 seconds to lock the display. While in the locked state, you will not be able to change any settings on the display nor dispense ice and water. The Control Locked indicator will flash and illuminate and an audible warning tone will sound. Press and hold  a second time to unlock the display.
light		Toggles dispenser light On and Off.

CONTROLS - FRIGIDAIRE & FRIGIDAIRE GALLERY

Alarms

- Power Failure** In the event of a power failure, the power fail alert will be illuminated. Press alarm reset to acknowledge the alarm. Other modes may be turned off until the alarm is acknowledged. When the power fail alert is acknowledged, the refrigerator will resume normal operation. The high temp alarm may also be illuminated until a safe operating range temperature has been reached.
- Freezer Temp** If the freezer temperature reaches 26°F or greater, the alarm will sound and the temperature will flash. You can disable the alarm by pressing the set key but the "High Temp" indicator will illuminate until the temperature goes below 26°F.
- Fresh Food Temp** If the fresh food temperature reaches 55°F or greater, the alarm will sound and the temperature will flash. You can disable the alarm by pressing the set key but the "High Temp" indicator will illuminate until the temperature goes below 55°F.
- Door Ajar** If the freezer or fresh food doors have been left open for five minutes or more, an alarm will sound and the door ajar indicator will illuminate on the display. Press the set key to reset any system alarms.
- Flapper** When "Cube" or "Crush" is selected, if the flapper (or ice chute door) is being held open by a jammed ice cube, an alarm will sound for two minutes. The alarm will reset after 2 minutes or when the ice cube is removed and the set key is pressed to reset.

Sabbath Mode

The Sabbath Mode is a feature that disables portions of the refrigerator and its controls in accordance with observance of the weekly Sabbath and religious holidays within the Orthodox Jewish community.

Sabbath Mode is turned ON and OFF by pressing and holding both the "v" and "+" for five seconds. The display shows "Sb" while in Sabbath mode.

In the Sabbath Mode, the High Temp alarm is active for health reasons. For example, if the door is left ajar the High Temp alarm is activated. The refrigerator will function normally once the door is closed, without any violation of the Sabbath/Holidays. The High Temp alarm is permitted when cabinet temperature is outside the safe zone for 20 minutes. The alarm silences itself after 10 minutes while the High Temp icon stays lit until the Sabbath mode is exited.

For further assistance, guidelines for proper usage and a complete list of models with the Sabbath feature, please visit the web at <http://www.star-k.org>.



NOTE

While in Sabbath Mode, neither the lights, dispenser, nor the control panel will work until Sabbath Mode is deactivated.

Refrigerator stays in Sabbath Mode after power failure recovery. It must be deactivated with the buttons on the control panel.

NOTE

Although you have entered the Sabbath Mode, the ice maker will complete the cycle it had already initiated. The ice cube compartment will remain cold and new ice cubes can be made with standard trays.

CONTROLS - FRIGIDAIRE PROFESSIONAL

User Interface In-Door Controls (options may vary)

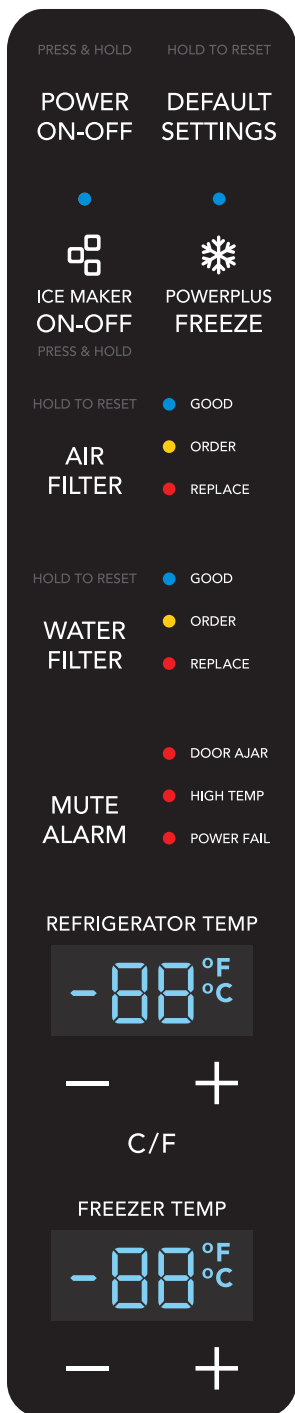

POWER ON-OFF	Press and hold for 3 seconds to turn off the cooling system. It also turns off the ice maker and all dispenser functions. The display will read "OFF".
DEFAULT SETTINGS	Press and hold for 3 seconds to reset all refrigerator settings to their factory default settings.
ICE MAKER ON-OFF	Press and hold for 3 seconds to toggle the ice maker in the freezer compartment "ON" or "OFF".
POWERPLUS FREEZE	Activates a faster rate for freezing food and increases ice production in the freezer. Deactivates after 12 hours.
AIR FILTER	Displays the current status of the air filter (GOOD, ORDER, or REPLACE). To reset the filter status to "GOOD", press and hold for 3 seconds.
WATER FILTER	Displays the current status of the water filter (GOOD, ORDER, or REPLACE). To reset the filter status to "GOOD", press and hold for 3 seconds.
REFRIGERATOR TEMP	Allows the temperature set-points to be adjusted. Press the "-" or "+" indicator to adjust the temperature to the desired setting. Control temperatures range from +33°F / +1°C to +43°F / +6°C.
FREEZER TEMP	Allows the temperature set-points to be adjusted. Press the "-" or "+" indicator to adjust the temperature to the desired setting. Control temperatures range from -6°F / -21°C to +4°F / -16°C.

CONTROLS - FRIGIDAIRE PROFESSIONAL

Dispenser Controls (options may vary)

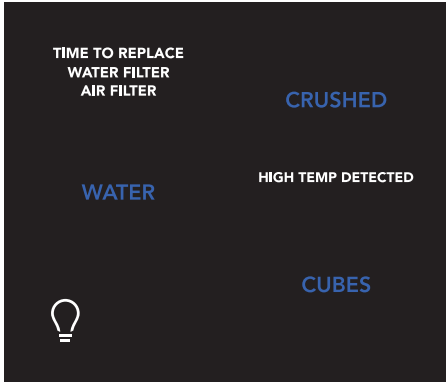

WATER Press the "WATER" key to select water.

CUBES Press the "CUBES" key to select cubed ice.

CRUSHED Press the "CRUSHED" key to select crushed ice.

light  Toggles dispenser light on and off.

Alarms

Power Failure

In the event of a power failure, the "POWER FAIL" alert will be illuminated. Press "MUTE ALARM" to acknowledge the alarm. Other modes may be turned off until the alarm is acknowledged. While a "POWER FAIL" alert is displayed on the control panel, the unit will continue normal operation. The "POWER FAIL" alert on the control panel will be removed once the user acknowledges the power fail condition by pressing "MUTE ALARM" or "DEFAULT SETTINGS".

Freezer Temp

If the freezer temperature reaches 26°F or greater, the alarm will sound and the temperature will flash and the dispenser control will display "HIGH TEMP DETECTED". You can disable the alarm by pressing "MUTE ALARM" but the "HIGH TEMP DETECTED" indicator will illuminate until the temperature goes below 26°F.

Fresh Food Temp

If the fresh food temperature reaches 55°F or greater, the alarm will sound and the temperature will flash and the dispenser control will display "HIGH TEMP DETECTED". You can disable the alarm by pressing "MUTE ALARM" but the "HIGH TEMP DETECTED" indicator will illuminate until the temperature goes below 55°F.

Door Ajar

If the freezer or fresh food doors have been left open for five minutes or more, an alarm will sound and the door ajar indicator will illuminate on the display. Press "MUTE ALARM" to reset any system alarms.

Flapper

When "CUBES" or "CRUSHED" is selected, if the flapper (or ice chute door) is being held open by a jammed ice cube, an alarm will sound for two minutes and the current selection will blink on the dispenser control. The alarm will reset after two minutes or when the ice cube is removed.

Sabbath Mode

The Sabbath Mode is a feature that disables portions of the refrigerator and its controls in accordance with observance of the weekly Sabbath and religious holidays within the Orthodox Jewish community.

Sabbath Mode is turned ON and OFF by simultaneously pressing and holding both the freezer “-” and the refrigerator “+” for five seconds. The display shows “Sb” while in Sabbath mode.

In the Sabbath Mode, the “HIGH TEMP” alarm is active for health reasons. For example, if the door is left ajar the “HIGH TEMP” alarm is activated. The refrigerator will function normally once the door is closed, without any violation of the Sabbath/Holidays. The “HIGH TEMP” alarm is permitted when cabinet temperature is outside the safe zone for 20 minutes. The alarm silences itself after 10 minutes while the “HIGH TEMP” icon stays lit until the Sabbath mode is exited.



For further assistance, guidelines for proper usage and a complete list of models with the Sabbath feature, please visit the web at <http://www.star-k.org>.

NOTE

While in Sabbath Mode, neither the lights, dispenser, nor the control panel will work until Sabbath Mode is deactivated.

Refrigerator stays in Sabbath Mode after power failure recovery. It must be deactivated with the buttons on the control panel.

NOTE

Although you have entered the Sabbath Mode, the ice maker will complete the cycle it had already initiated. The ice cube compartment will remain cold and new ice cubes can be made with standard trays.

STORAGE FEATURES



CAUTION

To avoid personal injury or property damage, handle tempered glass shelves carefully. Shelves may break suddenly if nicked, scratched, or exposed to sudden temperature change. Allow the glass shelves to stabilize to room temperature before cleaning. Do not wash in dishwasher.

Cantilever Shelf Adjustment

Refrigerator shelves are easily adjusted to suit individual needs. Before adjusting the shelves, remove all food. Cantilever shelves are supported at the back of the refrigerator.

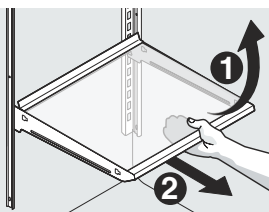

Cantilever Glass Shelf

To adjust cantilever shelves:

1. Lift front edge up.
2. Pull shelf out.

Replace the shelf by inserting the hooks at rear of the shelf into the wall bracket. Lower the shelf into the desired slots and lock into position.

Door storage

Door bins and shelves are provided for convenient storage of jars, bottles, and cans. Frequently used items can be quickly selected.

Some models have door bins that can accommodate gallon-sized plastic drink containers and economy-sized jars and containers. Some bins are adjustable for maximum storage capacity.

The dairy compartment, which is warmer than the general food storage section, is intended for short term storage of cheese, spreads, or butter.

Fresh Drawers with Humidity Control (some models)

The fresh drawers, located under the bottom refrigerator shelf, are designed for storing fruits, vegetables, and other fresh produce. The fresh drawers feature humidity control which allows you to adjust the humidity within the drawer. This can extend the life of fresh vegetables that keep best in high humidity. Wash items in clear water and remove excess water before placing them in the crispers.

Items with strong odors or high moisture content should be wrapped before storing.

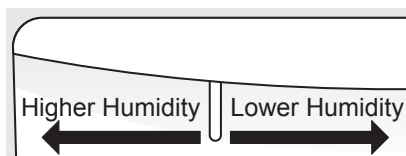

Crisper Humidity Control

NOTE

Leafy vegetables keep best when stored with the humidity control set on **Higher Humidity**, or in a drawer without a Humidity Control. This keeps incoming air to a minimum and maintains maximum moisture content.

Crispers

Crispers allow you the flexibility to store any manner of items including fruits, vegetables, nuts, etc. Crispers do not feature humidity controls.

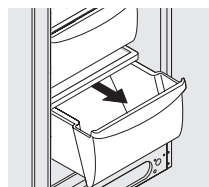

Crisper Drawer

Cool Drawer (some models)

Some models are equipped with a Cool Drawer for storage of luncheon meats, spreads, cheeses, and other deli items. This drawer does not have a separate temperature control.

Chill Drawer (some models)

Some models are equipped with a Chill Drawer. Chill Drawer temperatures can be adjusted by sliding the Chill Drawer Temperature Control in either direction. Use this pan for short term storage of bulk meat items. If meats are to be kept longer than one or two days, they should be frozen. The Chill Drawer is fixed and cannot be moved up or down. If fruits or vegetables are to be stored in the Chill Drawer, set the Chill Drawer Temperature Control to a warmer setting to prevent freezing.

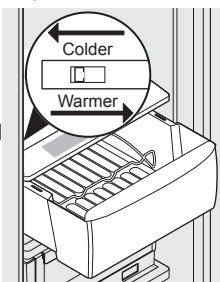

Chill Drawer with Temperature Control

AUTOMATIC ICE & WATER DISPENSER - FRIGIDAIRE GALLERY (SOME MODELS)

Priming the Water Supply System

Your refrigerator's water supply system includes several tubing lines, an advanced water filter, and a distribution valve bank to ensure ample supply to the ice and water dispenser at all times. This system needs to be completely filled with water when first connected to an external supply line.



CAUTION

For proper dispenser operation, recommended water supply pressure should fall between 30 psi and 100 psi. Excessive pressure may cause water filter to malfunction.

To prime the water supply system:

1. Begin filling the system by pressing and holding a drinking glass against the water dispenser paddle.
2. Keep the glass in this position until water comes out of the dispenser. It may take about 1½ minutes.
3. Continue dispensing water for about four minutes to flush the system and plumbing connections of any impurities (stopping to empty the glass as necessary).



NOTE

The water dispenser has a built-in device that shuts off the water flow after three minutes of continuous use. To reset this shutoff device, simply release the dispenser paddle.



NOTE

Dispensed water is not chilled. For colder water, add ice to cup or container before dispensing water.

Ice Maker Operation & Care

The ice maker, ice bin, and dispenser feeding mechanism are located in the top of the freezer compartment. After the refrigerator is installed properly and has cooled for several hours, the ice maker can produce ice within 24 hours. It can completely fill an ice bin in about two days.

Ice Production: What to Expect

How much ice will a side-mounted ice maker produce in 24 hours?

A side mounted ice maker will produce 4 to 4.5 pounds of ice every 24 hours, depending on usage conditions. Ice is produced at a rate of 8 cubes every 75 to 90 minutes.

How much ice can be stored in the bin?

When completely full, the bin in standard depth units will hold about 9.5 pounds of ice. The bin in counter depth units will hold about 5.5 pounds of ice.

Using the Ice Maker after Installation

Before making ice for the first time, be sure to prime the water supply system. Air in new plumbing lines can result in two or three empty ice maker cycles. Furthermore, if the system is not flushed, the first ice cubes may be discolored or have an odd flavor.



IMPORTANT

Your ice maker is shipped from the factory with the wire signal arm in the ON position. To ensure proper function of your ice maker, hook up water supply immediately or turn ice maker OFF by lifting the wire signal arm until it clicks and locks in the UP position.

If the ice maker is not turned off and the water supply is not connected, the water valve will make a loud chattering noise.

AUTOMATIC ICE & WATER DISPENSER - FRIGIDAIRE GALLERY (SOME MODELS)

Turning the SIDE MOUNTED Ice Maker On and Off

To begin ice production, lower the wire signal arm to the DOWN or ON position. The ice maker turns off automatically when the ice container becomes full. To stop the ice maker, raise the wire signal arm until it clicks and locks in the UP or OFF position.

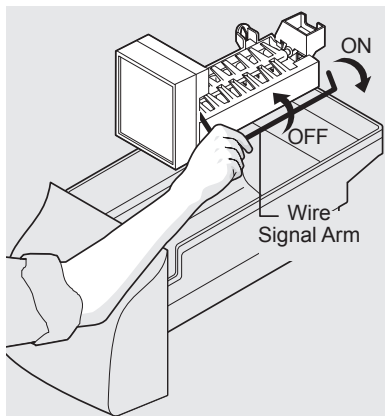

Ice Maker/Dispenser Tips

- Ice cubes stored too long may develop an odd flavor. Empty the ice container as explained below.
- Occasionally shake the ice container to keep ice separated.
- If your refrigerator is not connected to a water supply or the water supply is turned off, turn Off the ice maker.
- If you need a large quantity of ice at one time, it is best to get cubes directly from the ice container.
- The following sounds are normal when the ice maker is operating:
 - Motor running
 - Ice dropping into ice container
 - Water valve opening or closing
 - Ice loosening from tray
 - Running water
- When dispensing ice, you will hear a snapping or clicking sound when the ice chute opens and closes.
- To avoid splashing, dispense ice into your container before adding liquids.
- It is normal for ice to fill to the top of the ice bin.
- Turn Off the ice maker when cleaning the freezer and during vacations.
 - If you turn **Off** the ice maker for a long period of time, you should also turn off the water supply valve.



IMPORTANT

Small ice cubes or ice chips jamming in the ice maker may be a sign that your water filter needs changing. If you have a side mounted ice maker you may also experience hollow cubes partially frozen cubes with water inside. When these cubes are harvested, they break open and spill water over the other ice cubes in the ice container, forming a solid mass of ice. As the water filter nears the end of its useful life and becomes clogged with particles, less water is delivered to the ice maker during each cycle. The ice maker can't fill every cube in the ice maker mold, leading to small cubes or chips that can get caught between the ice ejector blades and the stripper. Remember, if your ice maker is jamming with small ice cubes or it's been six months or longer since you last changed your water filter replace the water filter with a new one. Poor quality household water may require the filter to be changed more frequently.



CAUTION

Chemicals from a malfunctioning water softener can damage the ice maker. If the water supply to your refrigerator is softened, be sure the softener is maintained to work properly.

AUTOMATIC ICE & WATER DISPENSER - FRIGIDAIRE GALLERY (SOME MODELS)

Cleaning the Ice Maker

Clean the ice maker and ice bin at regular intervals, particularly before you take a vacation or move.

To clean the ice maker:

1. Turn **Off** the ice maker.
2. Remove the ice bin by lifting up and out.
3. Empty and carefully clean the ice bin with mild detergent. Rinse with clear water. Do not use harsh or abrasive cleaners.
4. Allow the ice bin to dry completely before replacing in the freezer.
5. Remove ice chips and clean the ice bin shelf and the freezer door chute.
6. Replace the ice bin. Turn On the ice maker to resume ice production.

Remove and empty the ice storage bin if:

- An extended power failure (one hour or longer) causes ice cubes in the ice storage bin to melt and freeze together, jamming the dispenser mechanism.
- You do not use the ice dispenser frequently. Ice cubes will freeze together in the bin, jamming the dispenser mechanism.

Remove the ice storage bin and shake to loosen the cubes or clean as explained above.



IMPORTANT

When removing or replacing the ice bin, ensure that the ice bin is fully seated before closing the freezer door. If the ice bin is not positioned correctly the refrigerator will not dispense ice. The freezer door also may not close properly causing warm air to leak into the freezer compartment.



CAUTION

NEVER use an ice pick or similar sharp instrument to break up the ice. This could damage the ice storage bin and dispenser mechanism.

AUTOMATIC ICE & WATER DISPENSER - FRIGIDAIRE GALLERY/PRO (SOME MODELS)

Priming the water supply system



CAUTION

For proper dispenser operation, recommended water supply pressure should fall between 30 psi and 100 psi. Excessive pressure may cause the system to malfunction.

1. Begin filling the system by pressing and holding a drinking glass against the water dispenser paddle.

2. Keep the glass in this position until water comes out of the dispenser. It may take about 1½ minutes.



**Dispenser
(varies by model)**

3. Continue dispensing water for about four minutes to flush the system and plumbing connections of any impurities (stopping to empty the glass as necessary).

NOTE

The water dispenser has a built-in device that shuts off the water flow after three minutes of continuous use. To reset this shutoff device, simply release the dispenser paddle.

NOTE

Dispensed water is not chilled. For colder water, add ice to cup or container before dispensing water.

Ice Maker and Storage Bin Capacity

This ice maker should produce 2.5 to 3 pounds of ice per 24 hours, depending on usage conditions. Ice is produced at a rate of 10 cubes every 75 to 90 minutes.

How much ice can be stored in the ice bin?

When completely full, the bin in standard depth units will hold about 11 pounds of ice (total weight of ice and bin will be about 15 pounds). The bin in counter depth units will hold about 8.5 pounds of ice (total weight of ice and bin will be about 12 pounds).

Turning the ice maker on and off

Ice production is controlled by the ice maker's On/Off feature on the control panel. Pressing and holding the On/Off button toggles the ice maker On/Off.



IMPORTANT

Turning off the ice maker simply disables ice making. You will still be able to dispense existing ice, and you will still be able to dispense water.

NOTE

The ice maker also has a built-in plastic signal arm that automatically stops ice production when the ice bin is full. This signal arm should not be used to manually stop the ice maker.

Ice maker operation & care

After the refrigerator is installed properly and has cooled for several hours, the ice maker can produce ice within 24 hours. The ice maker will fill the ice bin from the rear. You must dispense some ice to force the ice forward in the bin. This will allow the bin to fill completely.

AUTOMATIC ICE & WATER DISPENSER - FRIGIDAIRE GALLERY/PRO (SOME MODELS)

Using the ice maker after installation

Before making ice for the first time, be sure to prime the water supply system. Air in new plumbing lines can result in two or three empty ice maker cycles. Furthermore, if the system is not flushed, the first ice cubes may be discolored or have an odd flavor.



IMPORTANT

Your ice maker is turned on at the factory so it can work as soon as you install your refrigerator. If you cannot connect a water supply, set the ice maker's On/Off feature to Off; otherwise, the ice maker's fill valve may make a loud chattering noise when it attempts to operate without water.



IMPORTANT

On occasion, unusually small ice cubes may be noticed in the bucket or in dispensed ice. This could occur in normal operation of the ice maker. If you start seeing these more frequently, it may be an indication of low water pressure or the water filter needs to be replaced. As the water filter nears the end of its useful life and becomes clogged with particles, less water is delivered to the ice maker during each cycle. Remember, if it's been six months or longer since you last changed your water filter, replace the water filter with a new one. Poor quality household water may require the filter to be changed more frequently.

Ice maker/dispenser tips

- If your refrigerator is not connected to a water supply or the water supply is turned off, turn off the ice maker as described in the previous section.
- The following sounds are normal when the ice maker is operating:
 - Motor running
 - Ice dropping into ice bin
 - Water valve opening or closing
 - Running water
- When dispensing ice, you will hear a snapping or clicking sound when the ice chute opens and closes.
- If you need a large quantity of ice at one time, it is best to get cubes directly from the ice bin.
- Ice cubes stored too long may develop an odd flavor. Empty the ice bin as explained below.
- When dispensing cubed ice, it is normal to have a small quantity of little pieces along with the whole cubes.
- To avoid splashing, dispense ice into your container before adding liquids.
- It is normal for ice to fill to the top of the ice bin.



CAUTION

If the water supply to your refrigerator is softened, be sure the softener is properly maintained. Chemicals from a water softener can damage the ice maker.

AUTOMATIC ICE & WATER DISPENSER - FRIGIDAIRE GALLERY/PRO (SOME MODELS)

Cleaning the storage bin

Clean the ice maker and ice bin at regular intervals, especially prior to vacation or moving.

1. Turn off the ice maker.
2. Remove the ice bin by lifting up slightly on the front of the bin and pulling it straight out of the ice maker housing.

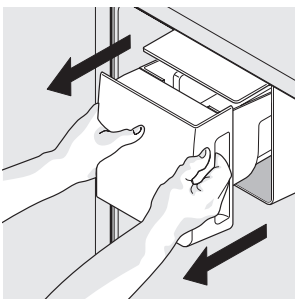

Removing Ice Bin

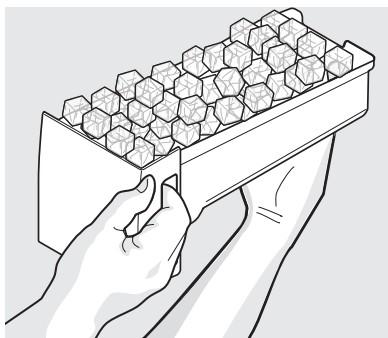

CAUTION

Be sure to firmly support the underside of the ice bin when removing it from the refrigerator. A standard depth bin that is full of ice will weigh about 15 pounds total, and a counter depth bin that is full of ice will weigh about 12 pounds total.

3. Empty and carefully clean the ice bin with mild detergent. Do not use harsh or abrasive cleaners. Rinse with clear water.
4. Allow the ice bin to dry completely before replacing in the freezer.
5. Remove ice chips and clean the ice bin shelf and the freezer door chute.
6. Replace the ice bin. Turn the ice maker on to resume ice production.

Remove and empty the ice bin if:

- An extended power failure (1 hour or longer) causes ice cubes in the ice bin to melt and refreeze together after power is restored, jamming the dispenser mechanism.
- You do not use the ice dispenser frequently. Ice cubes will freeze together in the bin, jamming the dispenser mechanism.

Remove the ice bin and shake to loosen the cubes or clean as explained above.



CAUTION

NEVER use an ice pick or similar sharp instrument to break up the ice. This could damage the ice bin and dispenser mechanism.

To loosen stuck ice, use warm water. Before replacing the ice bin, make sure it is completely dry.



IMPORTANT

When removing or replacing the ice bin, ensure that the ice bin is fully seated before closing the freezer door. If the ice bin is not positioned correctly the refrigerator will not dispense ice. The freezer door also may not close properly causing warm air to leak into the freezer compartment.

CHANGING THE FILTER - FRIGIDAIRE GALLERY

Locating the Filter

Your refrigerator is equipped with a water filtering system. The water filter system filters all dispensed drinking water, as well as the water used to produce ice.

Air Filter (some models)

The air filter is located at the top of the fresh food compartment next to the water filter.

Replacing the Air Filter

In general, you should change the air filter every six months (the filter status light on the control panel prompts you to replace the filter after six months) to ensure optimal filtering of refrigerator odors. You may want to adjust this time period depending on the types and amounts of food you typically store in your refrigerator. To replace your **PureSource Ultra™** air filter:

1. Pull the air filter housing straight out.
2. Remove the old filter and discard it.
3. Unpack the new filter and place it inside the housing.
4. Slide the housing back into position.

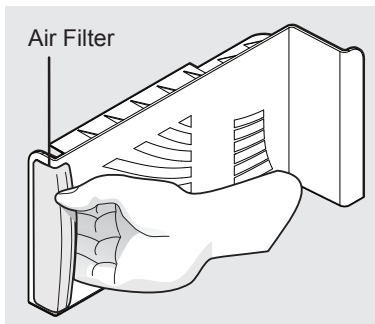

Water Filter

The water filter is located at the top right side of the fresh food compartment.

Replacing the Water Filter

In general, you should change the water filter every 6 months to ensure the highest possible water quality. Water Filter Status on the user interface prompts you to replace the filter after a standard amount of water (200 gallons/757 liters for **PureSource Ultra™**) has flowed through the system.

If your refrigerator has not been used for a period of time (during moving for example), change the filter before reinstalling the refrigerator.

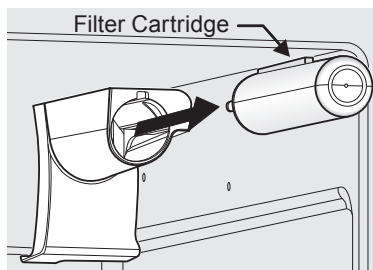

Ordering Replacement Filters

To order your replacement filters, please visit our online store at www.frigidaire.com/store, by calling toll-free at 1-800-374-4432, or by visiting the dealer where you purchased your refrigerator. Frigidaire recommends that you order extra filters when you first install your refrigerator, and that you replace your filters at least once every six months.

Here are the product numbers to request when ordering:

PureSource Ultra™ Water Filter
Part# **ULTRAWF**

CHANGING THE FILTER - FRIGIDAIRE GALLERY

More about your Advanced Water Filter



The **PureSource Ultra™** ice and water filter system is tested and certified to NSF/ANSI Standards 42, 53 and 401 for the reduction of claims specified on the performance data sheet.

Do not use with water that is microbiologically unsafe or of unknown quality without adequate disinfection before or after the system.

Systems certified for cyst reduction may be used on disinfected waters that may contain filterable cysts.

Test & certification results:

- Rated Capacity - 200 gallons/757 liters for **PureSource Ultra™** ice and water filter
- Rated service flow - .50 gallons per minute
- Operating Temp.: Min. 33°F, Max. 100°F
- Maximum Rated Pressure - 100 pounds per square inch
- Recommended Minimum Operating Pressure: 30 pounds per square inch

To replace your water filter:

It is not necessary to turn the water supply off to change the filter. Be ready to wipe up any small amounts of water released during the filter replacement.

1. Turn Off the ice maker.
2. Remove the filter by pushing on the end/face of the filter.
3. Slide the old water filter cartridge straight out of the housing and discard it.
4. Unpackage the new filter cartridge. Using the alignment guide, slide it gently into the filter housing until it stops against the snap-in connector at the back of the housing.
5. Push firmly until the cartridge snaps into place (you should hear a click as the cartridge engages the snap-in connector).
6. Press a drinking glass against the water dispenser while checking for any leaks at the filter housing. Any spurts and sputters that occur as the system purges air out of the dispenser system are normal.

7. After filling 1 glass of water, continue flushing the system for about 4 minutes.
8. Turn On the ice maker.
9. Press and hold the Water Filter button on the Ice & Water Dispenser control panel for 3 seconds. When the display changes from "Red" to "Green," the status has been reset.

CHANGING THE FILTER - FRIGIDAIRE PRO

Locating the Filters

Your refrigerator is equipped with water filtering system. The water filter system filters all dispensed drinking water, as well as the water used to produce ice. The filter is located in the top right rear corner of the fresh food compartment.

Water Filter

The water filter is located at the top right side of the fresh food compartment.

Replacing the Water Filter

In general, you should change the water filter every 6 months to ensure the highest possible water quality. **Water Filter Status** on the user interface prompts you to replace the filter after a standard amount of water (125 gallons/473 liters for **PureSource Ultra II™**) has flowed through the system.

If your refrigerator has not been used for a period of time (during moving for example), change the filter before reinstalling the refrigerator.

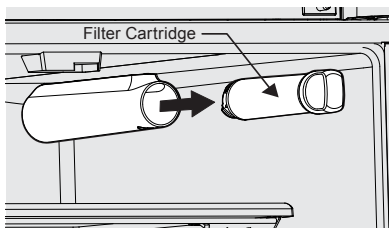

Ordering Replacement Filters

To order your replacement filters, please visit our online store at www.frigidaire.com/store, by calling toll-free at 1-800-599-7569, or by visiting the dealer where you purchased your refrigerator. Frigidaire recommends that you order extra filters when you first install your refrigerator, and that you replace your filters at least once every 6 months.

Here is the product number to request when ordering:

PureSource Ultra II™ Water Filter
Part #EPTWFO1

NOTE

When ordering your replacement filter, please reorder the same filter type that is currently in your refrigerator.

More about your Advanced Water Filter



The **PureSource Ultra II™** ice and water filter system is tested and certified to NSF/ANSI Standards 42, 53 and 401 for the reduction of claims specified on the performance data sheet.

Do not use with water that is microbiologically unsafe or of unknown quality without adequate disinfection before or after the system. Systems certified for cyst reduction may be used on disinfected waters that may contain filterable cysts.

Test & certification results:

- Rated Capacity - 125 gallons/473 liters for **PureSource Ultra II™** ice and water filter
- Rated service flow - .65 gallons per minute
- Operating Temp: Min. 33°F, Max. 100°F
- Maximum Rated Pressure - 100 pounds per square inch
- Recommended Minimum Operating Pressure: 30 pounds per square inch

To replace your **PureSource Ultra II™** water filter:

It is not necessary to turn the water supply off to change the filter. Be ready to wipe up any small amounts of water released during the filter replacement.

1. Turn Off the ice maker power switch.
2. Remove the old filter by rotating it counter-clockwise (to the left) 90 degrees to release it.
3. Slide the old filter cartridge straight out of the housing and discard it.
4. Unpackage the new filter cartridge. Slide it into the filter housing as far as it will go with the grip end horizontal.
5. Push lightly inward on the filter while rotating it clockwise (to the right). The filter will then pull itself inward as it is rotated. Rotate the filter 90 degrees until it stops and the grip end is vertical. You may be able to feel a very light click as the filter locks into place.
6. Press a drinking glass against the water dispenser while checking for any leaks at the filter housing. Any spurts and splutters that occur as the system purges air out of the dispenser system are normal.
7. Continue dispensing water for 3-4 minutes or until 1.5 gallons of water has flowed through the system. You will likely need to empty and refill your glass several times.
8. Turn On the ice maker.
9. Press and hold the Water Filter reset button on the control panel for three seconds. When the display changes from Red to Green, the status has been reset.

NORMAL OPERATING SOUNDS AND SIGHTS

Understanding the Sounds you may Hear

Your new, high-efficiency refrigerator may introduce unfamiliar sounds. These sounds normally indicate your refrigerator is operating correctly. Some surfaces on floors, walls, and kitchen cabinets may make these sounds more noticeable.

Following is a list of major components in your refrigerator and the sounds they can cause:

- A. Evaporator** Refrigerant through the evaporator may create a boiling or gurgling sound.
- B. Evaporator fan** You may hear air being forced through the refrigerator by the evaporator fan.
- C. Defrost heater** During defrost cycles, water dripping onto the defrost heater may cause a hissing or sizzling sound. After defrosting, a popping sound may occur.
- D. Automatic ice maker** When ice has been produced, you will hear ice cubes falling into the ice bin.
- E. Electronic control & automatic defrost control** These parts can produce a snapping or clicking sound when turning the cooling system on and off.
- F. Condenser fan** You may hear air being forced through the condenser.
- G. Compressor** Modern, high-efficiency compressors run much faster than in the past. The compressor may have a high-pitched hum or pulsating sound.
- H. Water valve** Makes a buzzing sound each time it opens to fill the ice maker.
- I. Drain pan** (not removable) You may hear water dripping into the drain pan during the defrost cycle.
- J. Condenser** May create minimal sounds from forced air.
- K. Motorized damper** May produce a light humming during operation.
- L. Ice chute** When dispensing ice, you will hear a snapping or clicking sound when the solenoid opens and closes the ice chute.

NOTE

Energy efficient foam in your refrigerator is not a sound insulator.

NOTE

During automatic defrost cycle, a red glow in the back wall vents of your freezer compartment is normal.

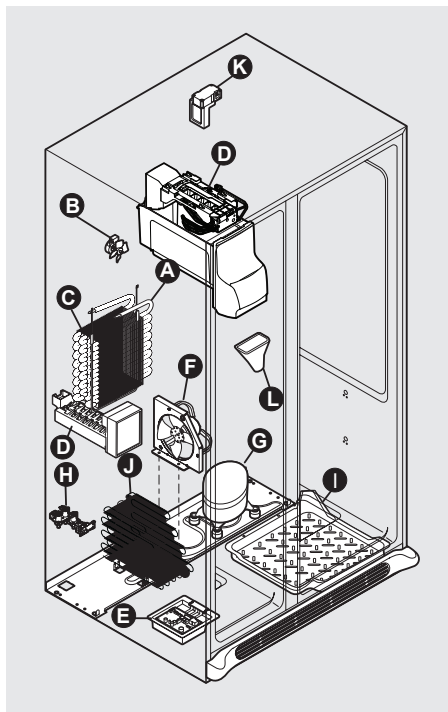

Protecting your investment

Keeping your refrigerator clean maintains appearance and prevents odor build-up. Wipe up any spills immediately and clean the freezer and fresh food compartments at least twice a year. When cleaning, take the following precautions:

- Never use CHLORIDE or cleaners with bleach to clean stainless steel.
- Do not wash any removable parts in a dishwasher.
- Always unplug the electrical power cord from the wall outlet before cleaning.
- Remove adhesive labels by hand. Do not use razor blades or other sharp instruments which can scratch the appliance surface.
- Do not remove the serial plate.

Do not use abrasive cleaners such as window sprays, scouring cleansers, brushes, flammable fluids, cleaning waxes, concentrated detergents, bleaches or cleansers containing petroleum products on plastic parts, interior doors, gaskets or cabinet liners. Do not use paper towels, metallic scouring pads, or other abrasive cleaning materials or strong alkaline solutions.

NOTE

If you set your temperature controls to turn off cooling, power to lights and other electrical components will continue until you unplug the power cord from the wall outlet.



CAUTION

- Pull the refrigerator straight out to move it. Shifting it from side to side may damage flooring. Be careful not to move the refrigerator beyond the plumbing connections.
- Damp objects stick to cold metal surfaces. Do not touch refrigerated surfaces with wet or damp hands.



IMPORTANT

If you store or move your refrigerator in freezing temperatures, be sure to completely drain the water supply system. Failure to do so could result in water leaks when the refrigerator is put back into service. Contact a service representative to perform this operation.

Vacation and moving tips

Occasion Tips

- | | |
|-----------------|--|
| Short Vacations | <ul style="list-style-type: none">• Leave refrigerator operating during vacations of three weeks or less.• Use all perishable items from refrigerator compartment.• Turn automatic ice maker off and empty ice bucket, even if you will only be gone a few days. |
| Long Vacations | <ul style="list-style-type: none">• Remove all food and ice if you will be gone one month or more.• Turn the cooling system off (see "Controls" section for location of On/Off button) and disconnect power cord.• Turn water supply valve to closed position.• Clean interior thoroughly.• Leave both doors open to prevent odors and mold build-up. Block doors open if necessary. |
| Moving | <ul style="list-style-type: none">• Remove all food and ice.• If using a handcart, load from the side.• Adjust rollers all the way up to protect them during sliding or moving.• Pad cabinet to avoid scratching surface. |

CARE & CLEANING

Care and Cleaning Tips

Part	Cleaning Agents	Tips and Precautions
Interior & Door Liners	<ul style="list-style-type: none">• Soap and water• Baking soda and water	<ul style="list-style-type: none">• Use two tablespoons of baking soda in one quart of warm water.• Be sure to wring excess water out of sponge or cloth before cleaning around controls, light bulb or any electrical part.
Door Gaskets	<ul style="list-style-type: none">• Soap and water	<ul style="list-style-type: none">• Wipe gaskets with a clean soft cloth.
Drawers & Bins	<ul style="list-style-type: none">• Soap and water	<ul style="list-style-type: none">• Use a soft cloth to clean drawer runners and tracks.• Do not wash any removable items (bins, drawers, etc.) in dishwasher.
Glass Shelves	<ul style="list-style-type: none">• Soap and water• Glass cleaner• Mild liquid sprays	<ul style="list-style-type: none">• Allow glass to warm to room temperature before immersing in warm water.
Toe Grille	<ul style="list-style-type: none">• Soap and water• Mild liquid sprays• Vacuum	<ul style="list-style-type: none">• Remove toe grille (see Installation Instructions).• Vacuum both sides and wipe with sudsy cloth or sponge. Rinse and dry.
Exterior & Handles	<ul style="list-style-type: none">• Soap and water• Non abrasive glass cleaner	<ul style="list-style-type: none">• Do not use commercial household cleaners containing ammonia, bleach or alcohol to clean handles.• Use a soft cloth to clean smooth handles.• Do not use a dry cloth to clean smooth doors.
Exterior & Handles (Stainless Steel Models Only)	<ul style="list-style-type: none">• Soap and water• Stainless steel cleaners	<ul style="list-style-type: none">• Never use CHLORIDE or cleaners with bleach to clean stainless steel.• Clean stainless steel front and handles with non-abrasive soapy water and a dishcloth. Rinse with clean water and a soft cloth.• Use a non-abrasive stainless steel cleaner. These cleaners can be purchased at most home improvement or major department stores. Always follow manufacturer's instruction. Do not use household cleaners containing ammonia or bleach. NOTE: Always clean, wipe and dry with grain to prevent scratching.• Wash the rest of the cabinet with warm water and mild liquid detergent. Rinse well and wipe dry with a clean soft cloth.
Replacing Light Bulbs	<ul style="list-style-type: none">• Unplug refrigerator• Wear gloves• Remove light cover• Replace old bulb• Replace light cover• Plug in the refrigerator	<ul style="list-style-type: none">• CAUTION: Wear gloves when replacing light bulbs to avoid getting cut.• Use same wattage when replacing bulb.

Replacing LED Lights (select models)

The fresh food compartments of your refrigerator may have LED lights. Always use Frigidaire parts for replacement.

To replace LED Lights:

1. Unplug your refrigerator's power cord.
2. Remove lens cover.
3. Remove LED board.
4. Replace LED board and snap in place assuring the light is facing in toward the unit (inside fresh food).
5. Replace lens cover.

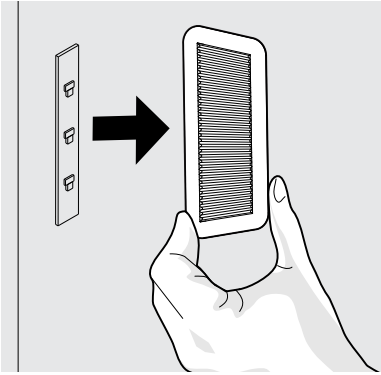

Lens Removal

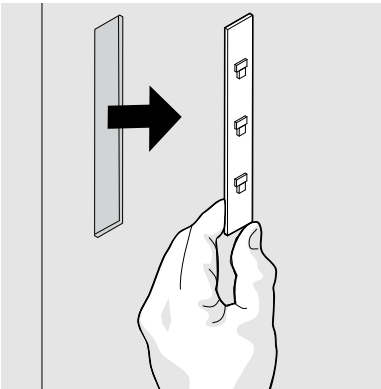

LED Light Board Removal

NOTE

LED lights are in series so if one is bad or unplugged, several lights may not light up.

Ordering Replacement LED Lights

Order new LEDs by calling 1-800-374-4432, online at www.frigidaire.com/store, or through the dealer where you bought the refrigerator. Here is the product number to request when ordering:

LED Light, Part #242196201

CARE & CLEANING

Replacing light bulbs (select models)

Both the freezer and fresh food compartments of your refrigerator include light bulbs that will need replacing from time to time. Some lights have covers that you will need to remove before replacing the bulbs. Always use bulbs that are designed for appliance lighting.

To replace light bulbs:



CAUTION

Wear gloves when replacing light bulbs to avoid getting cut.

1. Unplug your refrigerator's power cord.
2. Wear gloves as protection against possible broken glass.
3. Remove light cover, if necessary.
4. Unscrew and replace old bulb with an appliance bulb of the same type and wattage (normally 40 watts).
5. Replace light cover, if necessary.
6. Plug in the refrigerator's power cord.

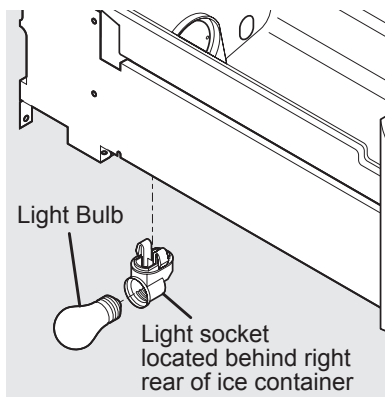
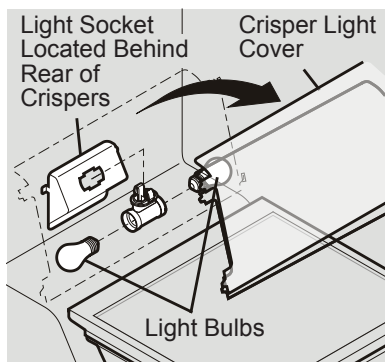
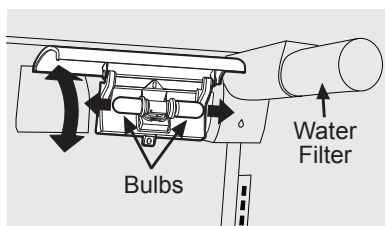

1-800-374-4432 (United States)
1-800-265-8352 (Canada)

Visit our web site at
www.frigidaire.com

CONCERN	CAUSE	SOLUTION
AUTOMATIC ICE MAKER		
<p>Ice maker is not making any ice.</p>	<ul style="list-style-type: none"> • Ice maker is turned off. • Refrigerator is not connected to water line or water valve is not open. • The water supply line is kinked. • The water filter is not seated properly. • The water filter may be clogged with foreign material. • Freezer ice maker wire signal arm is being held up by an item not allowing it to go in the on or down position. (Does not apply to Frigidaire Professional) 	<ul style="list-style-type: none"> • Turn on ice maker. Press and hold the "ON-OFF" button on the display panel for three seconds until the indicator light turns on. (Some Models) Move wire signal arm to the "down" position on the ice maker. • Connect the unit to the household water supply and ensure the water valve is open. • Ensure that the supply line does not kink when the refrigerator is pushed into place against the wall. • For Frigidaire Gallery, remove and re-install the water filter. Be sure to push the filter firmly so that you hear it lock solidly into position. <p>For Frigidaire Professional, remove and re-install the water filter. Remove by rotating it counter-clockwise (to the left) 90 degrees to release it. Re-install by sliding it into the filter housing as far as it will go with the grip end horizontal. Push lightly inward on the filter while rotating it clockwise (to the right). The filter will then pull itself inward as it is rotated. Rotate the filter 90 degrees until it stops and the grip end is vertical. You may be able to feel a very light click as the filter locks into place.</p> <ul style="list-style-type: none"> • If water dispenses slowly or not at all, or if the filter is six months old or older, it should be replaced. • Move any item or frozen ice cubes that may block the signal arm from being in the on or down position. See Automatic Ice Maker-Freezer section in manual.

BEFORE YOU CALL

CONCERN	CAUSE	SOLUTION
AUTOMATIC ICE MAKER (Continued)		
Ice maker is not making enough ice.	<ul style="list-style-type: none"> • Ice maker is producing less ice than you expect. • The water filter may be clogged with foreign material. • The water supply line is kinked. • Saddle valve on cold water pipe is clogged or restricted by foreign material. • Heavy traffic, opening or closing of the doors excessively. • Freezer control is set too warm. 	<ul style="list-style-type: none"> • The ice maker produces approximately 2.5 to 3 pounds every 24 hours depending on usage conditions. • If water dispenses slower than normal, or if the filter is 6 months old or older, it should be replaced. • Ensure that the supply line does not kink when the refrigerator is pushed into place against the wall. • Turn off household water line valve. Remove valve. Ensure that valve is not a self-piercing saddle valve. Clean valve. Replace valve if necessary. • Press Fast Freeze to temporarily increase ice production rate. (Does not apply to Frigidaire Professional.) • Set freezer control to colder setting to improve performance of the ice maker. Allow 24 hours for temperature to stabilize.
Ice maker will not stop making ice (select models).	<ul style="list-style-type: none"> • Ice maker wire signal arm is being held down by a package in the freezer that has fallen against ice maker. (Does not apply to Frigidaire Professional.) 	<ul style="list-style-type: none"> • Move any item or frozen ice cubes that may block the signal arm from being in the off or upward position. See Automatic Ice Maker-Freezer section in manual.
Ice cubes are freezing together.	<ul style="list-style-type: none"> • Ice cubes are not being used frequently enough or interruption of power for prolonged time. • Ice cubes are small or hollow (shells of ice with water inside). The hollow cubes break open in the bin and leak their water onto existing ice, which causes it to freeze together. 	<ul style="list-style-type: none"> • Remove ice container and discard ice. The ice maker will produce fresh supply. Ice should be used at least twice weekly to keep the cubes separated. • This generally occurs when the ice maker does not get enough water. This is usually the result of a clogged water filter or restricted water supply. Replace the water filter and if the condition still occurs check for a Saddle Valve, water valve not turned on all the way or kinked water supply line.
DISPENSER (Ice & Water)		
Dispenser will not dispense ice.	<ul style="list-style-type: none"> • Dispenser lock out is engaged. (Does not apply to Frigidaire Professional.) • There is no ice in the bin to be dispensed. • The refrigerator doors are not completely closed. • Dispenser paddle has been pressed too long and the dispenser motor has overheated. 	<ul style="list-style-type: none"> • Press and hold control lock for three seconds. • See the "Ice maker is not making any ice" section above. • Be sure the refrigerator doors are completely closed. • The motor overload protector will reset in about three minutes and then ice can be dispensed.

BEFORE YOU CALL

CONCERN	CAUSE	SOLUTION
DISPENSER (Ice & Water)(Continued)		
Ice dispenser is jammed.	<ul style="list-style-type: none"> • Ice has melted and frozen around auger due to infrequent use, temperature fluctuations, and/or power outages. • Ice cubes are jammed between ice maker and back of ice container. 	<ul style="list-style-type: none"> • Remove ice container, thaw, and empty the contents. Clean container, wipe dry, and replace in proper position. When new ice is made, dispenser should operate. • Remove ice cubes that are jamming the dispenser.
Dispenser will not dispense water.	<ul style="list-style-type: none"> • Dispenser lock out is engaged. (Does not apply to Frigidaire Professional.) • Water filter not seated properly. • Water filter is clogged. • Household water line valve is not open. 	<ul style="list-style-type: none"> • Press and hold control lock for 3 seconds. • For Frigidaire Gallery, remove and reinstall the water filter. Be sure to push the filter firmly so that you hear it lock solidly into position. For Frigidaire Professional, remove and reinstall the water filter. Be sure to press inward as you rotate it clockwise to lock it in place. • For Frigidaire Gallery, replace filter cartridge. Be sure to remove protective caps and push the filter firmly so that you hear it lock solidly into position. For Frigidaire Professional, replace filter cartridge. Be sure to press inward as you rotate it clockwise to lock it in place. • Open household water line valve. See CONCERN column AUTOMATIC ICE MAKER.
Water has an odd taste and/or odor.	<ul style="list-style-type: none"> • Water has not been dispensed for an extended period of time. • Unit not properly connected to cold water line. 	<ul style="list-style-type: none"> • Draw and discard 10-12 glasses of water to freshen the supply. • Connect unit to cold water line that supplies water to the kitchen faucet.
Water pressure is extremely low.	<ul style="list-style-type: none"> • Cut-off and cut-on pressures are too low (well systems only). • Reverse osmosis system is in regenerative phase. 	<ul style="list-style-type: none"> • Have someone turn up the cut-off and cut-on pressure on the water pump system (well systems only). • It is normal for a reverse osmosis system to be below 20 psi during the regenerative phase.
Water not cold enough.	<ul style="list-style-type: none"> • The water dispensing system is not designed to chill water. 	<ul style="list-style-type: none"> • Add ice to cup or container before dispensing water.

BEFORE YOU CALL

CONCERN	CAUSE	SOLUTION
OPENING/CLOSING OF DOORS/DRAWERS		
Door(s) will not close.	<ul style="list-style-type: none"> • Door was closed too hard, causing other door to open slightly. • Refrigerator is not level. It rocks on the floor when moved slightly. • Refrigerator is touching a wall or cabinet. 	<ul style="list-style-type: none"> • Close both doors gently. • Ensure floor is level and solid, and can adequately support the refrigerator. Contact a carpenter to correct a sagging or sloping floor. • Ensure floor is level and solid, and can adequately support the refrigerator. Contact a carpenter to correct a sagging or sloping floor.
Drawers are difficult to move.	<ul style="list-style-type: none"> • Food is touching shelf on top of drawer. • Track that drawers slide on is dirty. 	<ul style="list-style-type: none"> • Remove top layer of items in drawer. • Ensure drawer is properly installed on track. • Clean drawer, rollers, and track. See Care & Cleaning.
RUNNING OF REFRIGERATOR		
Compressor does not run.	<ul style="list-style-type: none"> • Freezer control is set to "OF" or "0". • Refrigerator is in defrost cycle. • Plug at electrical outlet is disconnected. • House fuse blown or tripped circuit breaker. • Power outage. 	<ul style="list-style-type: none"> • Set freezer control. • This is normal for a fully automatic defrost refrigerator. The defrost cycle occurs periodically, lasting about 30 minutes. • Ensure plug is tightly pushed into outlet. • Check/replace fuse with a 15 amp time-delay fuse. Reset circuit breaker. • Check house lights. Call local electric company.
Refrigerator runs too much or too long. (Single Speed Compressor) (Some Models)	<ul style="list-style-type: none"> • Room or outside weather is hot. • Doors are opened too frequently or too long. • Fresh Food/freezer door may be slightly open. • Freezer control is set too cold. • Fresh Food/freezer gasket is dirty, worn, cracked, or poorly fitted. • Condenser is dirty. 	<ul style="list-style-type: none"> • It's normal for the refrigerator to work longer under these conditions. • Warm air entering the refrigerator causes it to run more. Open doors less often. • Ensure refrigerator is level. Keep food and contains from blocking door. See PROBLEM column OPENING/CLOSING OF DOORS/DRAWERS. • Set Fresh Food control to warmer setting until refrigerator temperature is satisfactory. Allow 24 hours for temperature to stabilize. • Clean or change gasket. Leaks in door seal will cause refrigerator to run longer in order to maintain desired temperatures. • Clean condenser. See CARE & CLEANING.
Compressor goes off and on frequently.	<ul style="list-style-type: none"> • Thermostat keeps the refrigerator at a constant temperature. 	<ul style="list-style-type: none"> • This is normal. Refrigerator goes on and off to keep temperature constant. (Single Speed Compressor) (Some Models)

CONCERN	CAUSE	SOLUTION
RUNNING OF REFRIGERATOR (Continued)		
Refrigerator seems to run too much or too long. (Variable Speed Compressor) (Some Models)	<ul style="list-style-type: none"> Your variable speed compressor is designed to run 100% of the time except during the defrost cycle. At times it will run faster, such as after a defrost cycle. 	<ul style="list-style-type: none"> It is normal for the compressor to run continuously except during defrost mode.
DIGITAL TEMPERATURE DISPLAY		
Digital temperature displays are flashing.	<ul style="list-style-type: none"> Electronic control system has detected a performance problem. 	<ul style="list-style-type: none"> Call your Frigidaire service representative, who can interpret any messages or number codes flashing on the digital displays.
WATER/MOISTURE/FROST INSIDE REFRIGERATOR		
Moisture collects on inside of refrigerator walls.	<ul style="list-style-type: none"> Weather is hot and humid. Door is slightly open. 	<ul style="list-style-type: none"> The rate of frost buildup and internal sweating increases. See PROBLEM column OPENING/CLOSING OF DOORS/DRAWERS.
Water collects on bottom side of drawer cover.	<ul style="list-style-type: none"> Vegetables contain and give off moisture. 	<ul style="list-style-type: none"> It is not unusual to have moisture on the bottom side of the cover. Move humidity control (some models) to lower setting.
Water collects in bottom of drawer.	<ul style="list-style-type: none"> Washed vegetables and fruit drain while in the drawer. 	<ul style="list-style-type: none"> Dry items before putting them in the drawer. Water collecting in bottom of drawer is normal.
WATER/MOISTURE/FROST OUTSIDE REFRIGERATOR		
Moisture collects on outside of refrigerator or between doors.	<ul style="list-style-type: none"> Weather is humid. Door is slightly open, causing cold air from inside refrigerator to meet warm air from outside. 	<ul style="list-style-type: none"> This is normal in humid weather. When humidity is lower, the moisture should disappear. See PROBLEM column OPENING/CLOSING OF DOORS/DRAWERS.

MAJOR APPLIANCE WARRANTY

Your appliance is covered by a one year limited warranty. For one year from your original date of purchase, Electrolux will pay all costs for repairing or replacing any parts of this appliance that prove to be defective in materials or workmanship when such appliance is installed, used and maintained in accordance with the provided instructions.

Exclusions

This warranty does not cover the following:

1. Products with original serial numbers that have been removed, altered or cannot be readily determined.
2. Product that has been transferred from its original owner to another party or removed outside the USA or Canada.
3. Rust on the interior or exterior of the unit.
4. Products purchased "as-is" are not covered by this warranty.
5. Food loss due to any refrigerator or freezer failures.
6. Products used in a commercial setting.
7. Service calls which do not involve malfunction or defects in materials or workmanship, or for appliances not in ordinary household use or used other than in accordance with the provided instructions.
8. Service calls to correct the installation of your appliance or to instruct you how to use your appliance.
9. Expenses for making the appliance accessible for servicing, such as removal of trim, cupboards, shelves, etc., which are not a part of the appliance when it is shipped from the factory.
10. Service calls to repair or replace appliance light bulbs, air filters, water filters, other consumables, or knobs, handles, or other cosmetic parts.
11. Surcharges including, but not limited to, any after hour, weekend, or holiday service calls, tolls, ferry trip charges, or mileage expense for service calls to remote areas, including the state of Alaska.
12. Damages to the finish of appliance or home incurred during installation, including but not limited to floors, cabinets, walls, etc.
13. Damages caused by: services performed by unauthorized service companies; use of parts other than genuine Electrolux parts or parts obtained from persons other than authorized service companies; or external causes such as abuse, misuse, inadequate power supply, accidents, fires, or acts of God.

DISCLAIMER OF IMPLIED WARRANTIES; LIMITATION OF REMEDIES

CUSTOMER'S SOLE AND EXCLUSIVE REMEDY UNDER THIS LIMITED WARRANTY SHALL BE PRODUCT REPAIR OR REPLACEMENT AS PROVIDED HEREIN. CLAIMS BASED ON IMPLIED WARRANTIES, INCLUDING WARRANTIES OF MERCHANTABILITY OR FITNESS FOR A PARTICULAR PURPOSE, ARE LIMITED TO ONE YEAR OR THE SHORTEST PERIOD ALLOWED BY LAW, BUT NOT LESS THAN ONE YEAR. ELECTROLUX SHALL NOT BE LIABLE FOR CONSEQUENTIAL OR INCIDENTAL DAMAGES SUCH AS PROPERTY DAMAGE AND INCIDENTAL EXPENSES RESULTING FROM ANY BREACH OF THIS WRITTEN LIMITED WARRANTY OR ANY IMPLIED WARRANTY. SOME STATES AND PROVINCES DO NOT ALLOW THE EXCLUSION OR LIMITATION OF INCIDENTAL OR CONSEQUENTIAL DAMAGES, OR LIMITATIONS ON THE DURATION OF IMPLIED WARRANTIES, SO THESE LIMITATIONS OR EXCLUSIONS MAY NOT APPLY TO YOU. THIS WRITTEN WARRANTY GIVES YOU SPECIFIC LEGAL RIGHTS. YOU MAY ALSO HAVE OTHER RIGHTS THAT VARY FROM STATE TO STATE.

If You Need Service

Keep your receipt, delivery slip, or some other appropriate payment record to establish the warranty period should service be required. If service is performed, it is in your best interest to obtain and keep all receipts. Service under this warranty must be obtained by contacting Electrolux at the addresses or phone numbers below.

This warranty only applies in the USA and Canada. In the USA, your appliance is warranted by Electrolux Major Appliances North America, a division of Electrolux Home Products, Inc. In Canada, your appliance is warranted by Electrolux Canada Corp. Electrolux authorizes no person to change or add to any obligations under this warranty. Obligations for service and parts under this warranty must be performed by Electrolux or an authorized service company. Product features or specifications as described or illustrated are subject to change without notice.

USA
1-800-374-4432
Frigidaire
10200 David Taylor Drive
Charlotte, NC 28262



Electrolux

Canada
1.800.265.8352
Electrolux Canada Corp.
5855 Terry Fox Way
Mississauga, Ontario, Canada
L5V 3E4