

# OWNER'S MANUAL

# SEARS

Kenmore

## SEWING MACHINE

MODELS 11682

12581

12681

or

12781

## SEARS, ROEBUCK AND CO.

Dear Customer:

You have just invested in a very fine zigzag sewing machine. Before using your new Kenmore machine, please pause for a moment and carefully read this booklet which contains instructions on how to operate and care for your machine.

Specific instructions are given on threading, tension adjustments, cleaning, oiling, etc. This will help you obtain the best sewing results and avoid unnecessary service expense for conditions beyond our control.

Advice on the operation and care of your machine is always available at your nearest Sears Retail Store. Please remember, if you have questions about your machine or need parts and service, always mention the model number and serial number when you inquire.

### Kenmore Sewing Machine

Record in space provided below the model number and serial number of this appliance. The model number and serial number are located on the nomenclature plate, as identified on Page 3 of this booklet.

Model No. 385. \_\_\_\_\_ Serial No. \_\_\_\_\_

Retain these numbers for future reference.

THIS MODEL IS A CENTER NEEDLE, LOW BAR SEWING MACHINE.

# IMPORTANT SAFETY INSTRUCTIONS

Your sewing machine is designed and constructed only for HOUSEHOLD use. Read all instruction before using this sewing machine.

## **DANGER** — To reduce the risk of electric shock:

1. An appliance should never be left unattended when plugged in. Always unplug this appliance from the electric outlet immediately after using and before cleaning.
2. Always unplug before relamping. Replace bulb with same type rated 15 Watts.
3. Do not reach for the appliance that has fallen into water. Unplug immediately.
4. Do not place or store appliance where it can fall or be pulled into a tub or sink. Do not place in or drop into water or other liquid.

## **WARNING** — To reduce the risk of burns, fire, electric shock,

or injury to persons.

1. Do not allow to be used as a toy. Close attention is necessary when this appliance is used by or near children.
2. Use this appliance only for its intended use as described in this manual. Use only attachments recommended by the manufacturer as contained in this manual.
3. Never operate this appliance if it has a damaged cord or plug, if it is not working properly, if it has been dropped or damaged, or dropped into water. Return the appliance to the nearest authorized dealer or service center for examination, repair, electrical or mechanical adjustment.

4. Never operate the appliance with any air opening blocked. Keep ventilation openings of the sewing machine and foot controller free from accumulation of lint, dust, and loose cloth.
5. Never drop or insert any object into any opening.
6. Do not use outdoors.
7. Do not operate where aerosol (spray) products are being used or where oxygen is being administered.
8. To disconnect, turn all controls to the off ("O") position, then remove plug from outlet.
9. Do not unplug by pulling on cord. To unplug, grasp the plug, not the cord.
10. Keep fingers away from all moving parts. Special care is required around the sewing machine needle.
11. Always use the proper needle plate. The wrong plate can cause the needle to break.
12. Do not use bent needles.
13. Do not pull or push fabric while stitching. It may deflect the needle causing it to break.
14. Switch the sewing machine off ("O") when making any adjustment in the needle area, such as threading needle, changing needle, threading bobbin, or changing presser foot, and the like.
15. Always unplug the sewing machine from the electrical outlet when removing covers, lubricating, or when making any other user servicing adjustments mentioned in the instruction manual.

## SAVE THESE INSTRUCTIONS

## **OPERATING INSTRUCTIONS**

**"For appliances with a polarized plug (one blade wider than the other).**

To reduce the risk of electric shock, this plug is intended to fit in a polarized outlet only one way. If the plug does not fit fully in the outlet, reverse the plug. If it still does not fit, contact a qualified electrician to install the proper outlet. Do not modify the plug in any way."

**"Foot Controller Model YC-482P for use with Sewing Machine Models**

**385.1148xxx, 385.1158xxx, 385.1168xxx, 385.1258xxx, 385.1268xxx,  
385.12612xxx, 385.1278xxx, 385.11607xxx, 385.12710xxx, 385.12714xxx,  
385.12712xxx, 385.17622xxx, 385.11608xxx, 385.12814xxx and 385.12014xxx.**

**xxx - represents numbers 000 through 999."**

**(For U.S.A. market only)**

# TABLE OF CONTENTS

## SECTION 1. KNOW YOUR MACHINE

A Portable Case or Cabinet is Available . . . . .	2
Locate and Identify the Parts . . . . .	2~3
Identify the Accessories . . . . .	3

## SECTION 2. PREPARE YOUR MACHINE FOR SEWING

Set Up the Machine . . . . .	4~6
• Plug in the Machine and Switch on the Power . . . . .	4
• Foot Control Use . . . . .	4
• Setting Spool Pin . . . . .	5
• Adjust the Presser Foot Lever . . . . .	5
• Thread Cutter . . . . .	5
• Free Arm Sewing: the Removable Extension Table . . . . .	6
• Accessory Storage Box . . . . .	6
• Change the Presser Foot . . . . .	6
Choose Your Needle and Thread . . . . .	6~7
• To Change Your Needle . . . . .	6
• Check Your Needle . . . . .	7
• Fabric, Needle, Thread and Stitch Length Chart . . . . .	7
Prepare the Bobbin . . . . .	8~9
• To Remove the Bobbin Case from the Machine . . . . .	8
• Wind the Bobbin . . . . .	8~9
• Insert the Bobbin into the Bobbin Case . . . . .	9
Prepare Your Top Thread . . . . .	10~11
• Thread Your Needle . . . . .	10
• Pick Up Your Bobbin Thread . . . . .	11
Adjust the Top Thread Tension . . . . .	12~13
Stitch Selector . . . . .	14
Stitch Length Control . . . . .	14
Adjusting Stretch Stitch Balance . . . . .	15
Reverse Stitch Control . . . . .	15
Starting To Sew . . . . .	16

## SECTION 3. LEARN THE STITCHES

Straight Stitches . . . . .	17~18
• Straight Stitch . . . . .	17
• Use the Seam Guides . . . . .	17
• Turn a Square Corner . . . . .	17
• Use the Darning Plate . . . . .	18
• Topstitching . . . . .	18

• Left Needle Position . . . . .	18
Darning . . . . .	19
Straight Stretch . . . . .	19
Zigzag Stitches . . . . .	20~26
• Basic Zigzag . . . . .	20
• Satin Stitch . . . . .	21
• Applique . . . . .	22
• Bar Tacking . . . . .	22
• Sew a Button . . . . .	23
• Overcasting Stitch . . . . .	24
• Rick-Rack Stretch . . . . .	24
• Overcast Stretch Stitching (Models 12781, 12681 and 12581) . . . . .	25
• Serging or Pine Leaf Stretch Stitching (Model 12781 and 12681) . . . . .	25
• Three-Step Zigzag . . . . .	26
Lace Work (Models 12781, 12681 and 12581) . . . . .	26
Blind Hemming (Models 12781, 12681 and 12581) . . . . .	27
Buttonholes . . . . .	28~29
Sew in a Zipper . . . . .	30~31
Shell Stitching (Model 12781 and 12681) . . . . .	32
Smocking . . . . .	32
Elastic Stretch Stitch (Model 12781 only) . . . . .	33
Box Stitching (Model 12781 only) . . . . .	33

## SECTION 4. PERFORMANCE PROBLEMS CHART

What to Do When . . . . .	34~35
---------------------------	-------

## SECTION 5. CARE FOR YOUR MACHINE

Replacing the Light Bulb . . . . .	36
Cleaning the Machine . . . . .	36~37
• Clean the Feed Dogs . . . . .	36
• Clean the Shuttle Race . . . . .	37
Oiling the Machine . . . . .	38
• Oil behind the Face Cover Plate and under the Arm Cover Plate . . . . .	38
• Oil the Underside . . . . .	38

PARTS LIST . . . . .	39
----------------------	----

INDEX . . . . .	40
-----------------	----



## SECTION 1. KNOW YOUR MACHINE

### A Portable Case or Cabinet is Available

A full line of sewing cabinets are available at your nearest Sears retail store or through our general catalog.

Another option . . . buy a Carrying Case . . . then your Kenmore goes anywhere, can be stored anywhere.

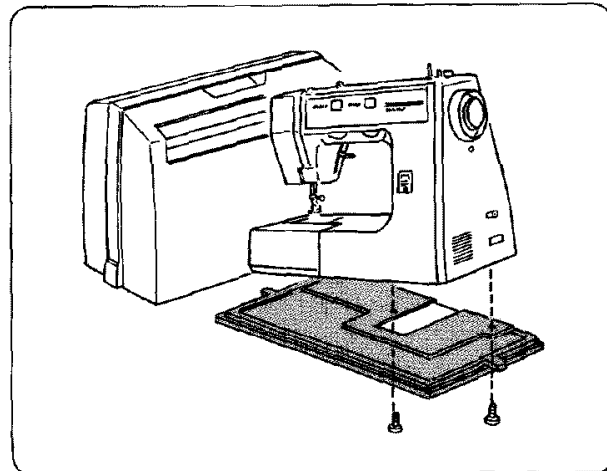
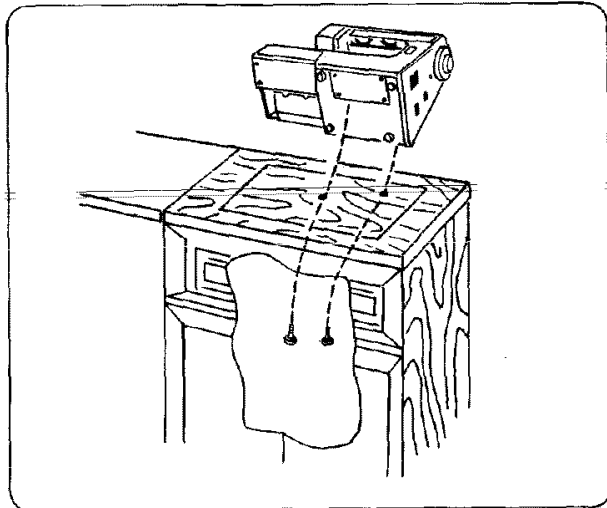

### Locate and Identify the Parts

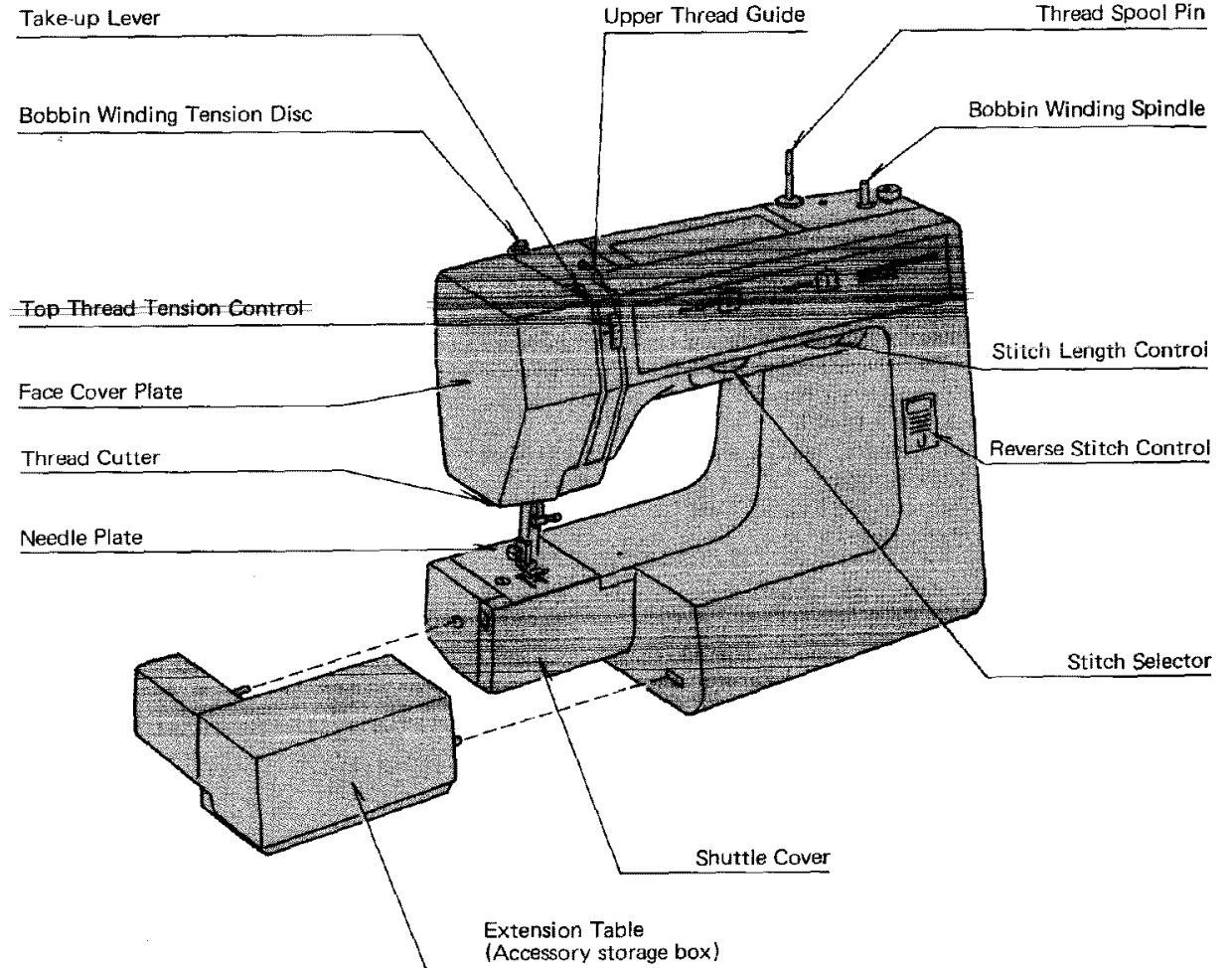

## SECTION 1. KNOW YOUR MACHINE

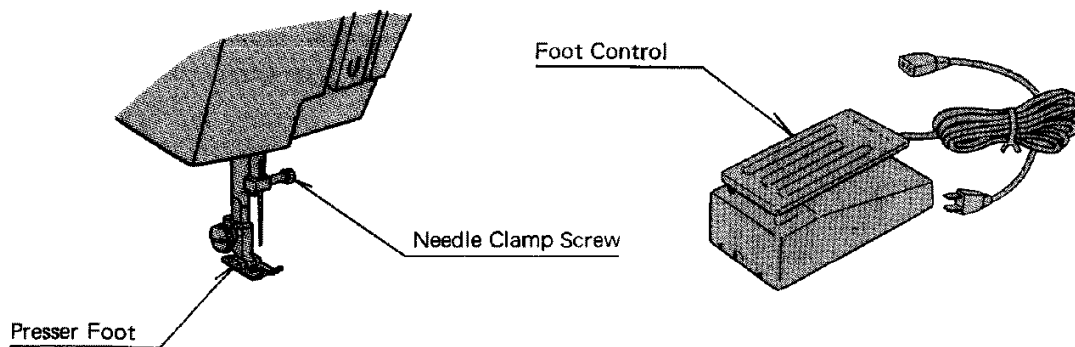
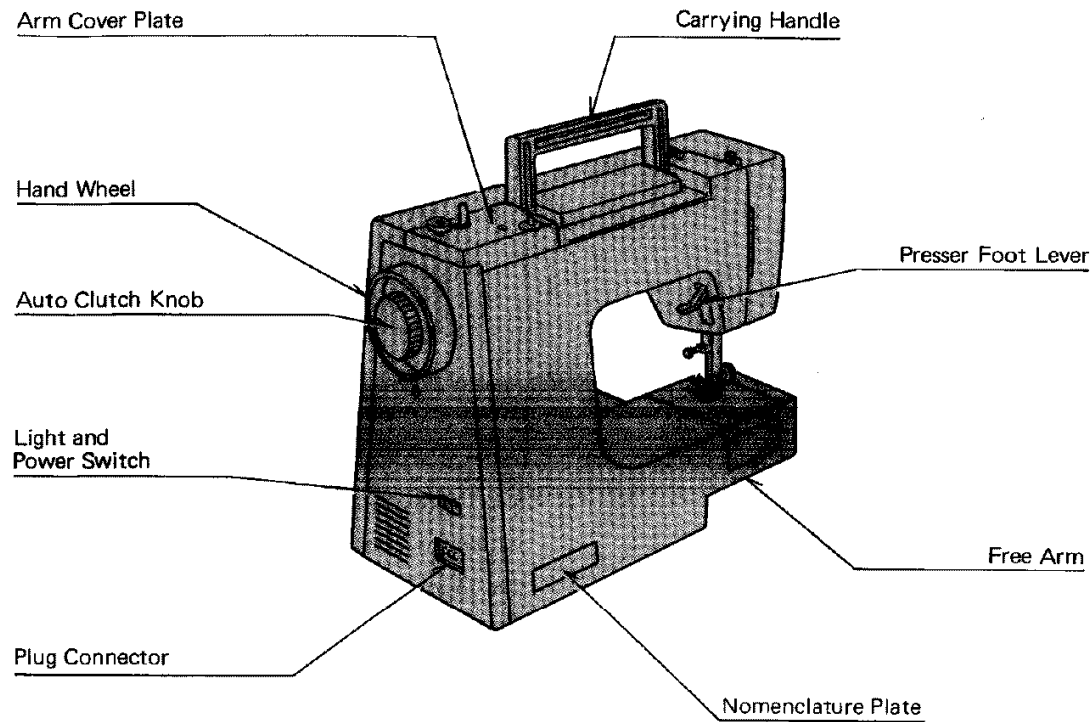

### Identify the Accessories

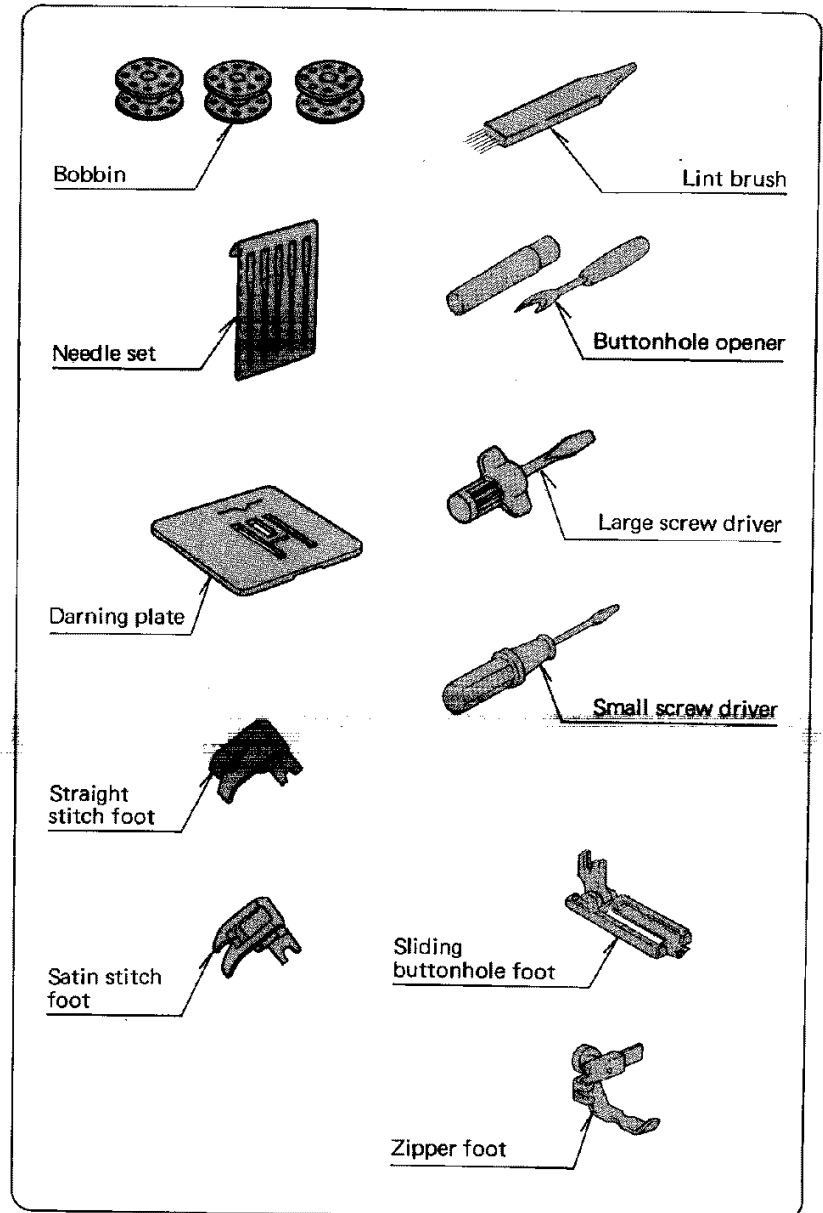

## SECTION 2. PREPARE YOUR MACHINE FOR SEWING

### Set Up the Machine

#### • Plug in the Machine and Switch on the Power

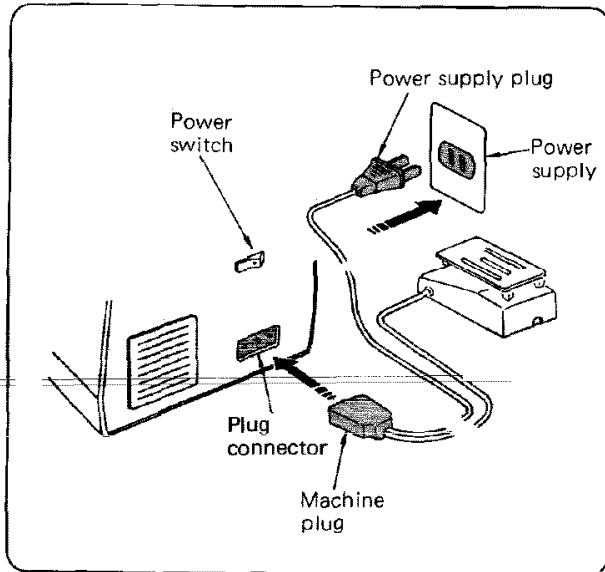

**NOTE:** Before inserting the plug into your machine, be sure the power switch is OFF.

1. Check your outlet to be sure it is a 110 to 120 Volt AC outlet.
2. Insert the machine plug into the three-prong plug connector, as shown. It will only fit one way.
3. Insert the power supply plug into the outlet.

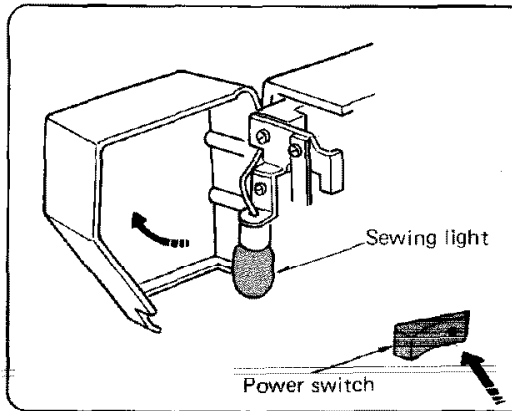

4. Push the light and power switch to turn on the power and sewing light.

#### SAFETY FEATURE:

Your machine will not operate unless the light/power switch is turned on. If you are interrupted or stop sewing, turn off the light/power switch to prevent injury to children.

#### • Foot Control Use

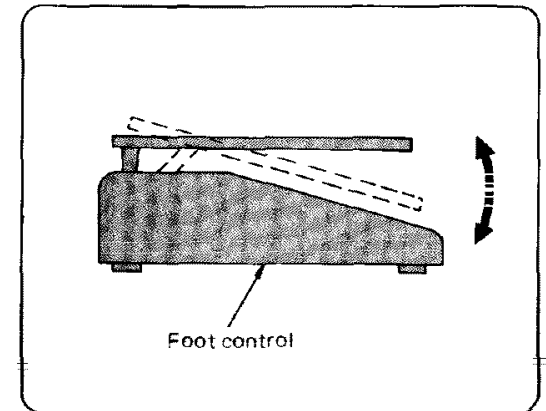

The foot control regulates the speed at which you sew.

To increase speed, gently press down with the ball of your foot.

To decrease speed, release your foot pressure slightly.

**NOTE:** The foot control is sensitive and will increase or decrease your sewing speed immediately. Practice on a scrap of fabric to regulate your sewing speed to your taste and needs.

## SECTION 2. PREPARE YOUR MACHINE FOR SEWING

### • Setting Spool Pin

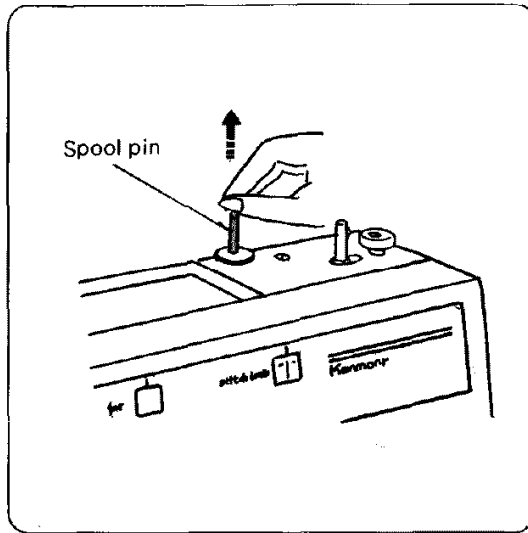

The spool pin is used for holding the spool of thread in order to feed thread to the machine.

To use, pull up the spool pin. Push down for storage.

### • Adjust the Presser Foot Lever

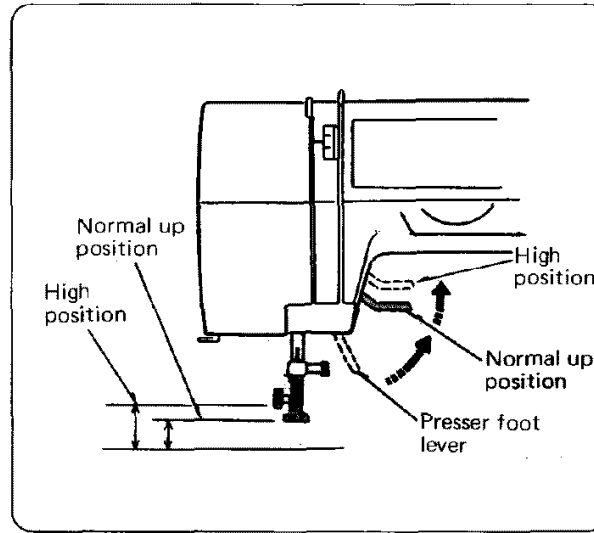

The Presser Foot Lever raises and lowers your presser foot.

You can raise it about 1/4" higher than the normal up position for easy removal of the presser foot or to help you place heavy fabrics under the presser

### • Thread Cutter

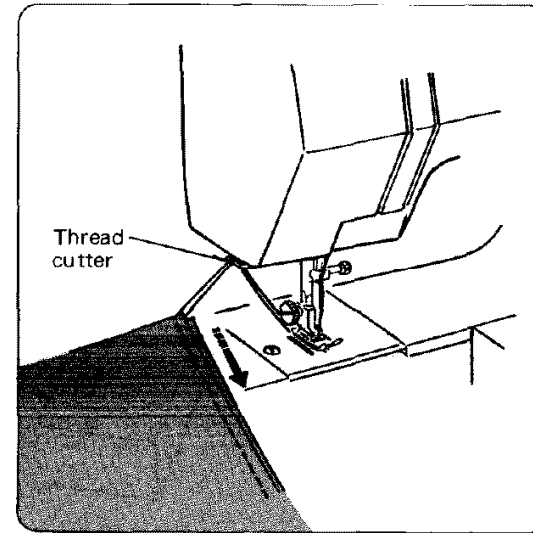

You don't need a pair of scissors to cut the thread after you finish sewing. Just use the handy thread cutter.

Pull the threads to lengthen several inches before starting the next seam.

## SECTION 2. PREPARE YOUR MACHINE FOR SEWING

### Set Up the Machine (Continued)

- Free-Arm Sewing: the Removable Extension Table

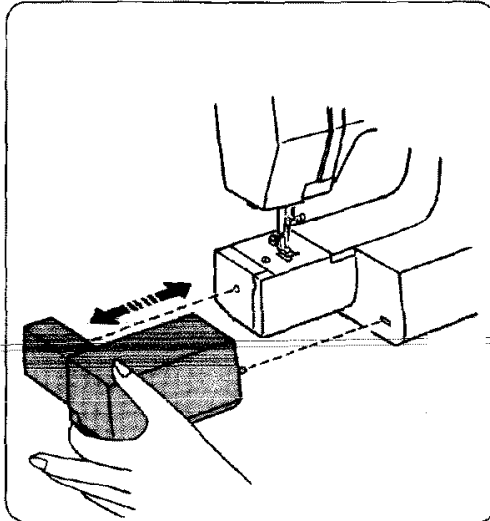

#### To Remove the Extension Table (for free-arm sewing)

1. Grip the table with your index finger and thumb, as shown.
2. Pull gently to the left. The extension table will snap out.

#### To Attach the Extension Table (for flat-bed sewing)

1. Insert the tab and the pin into their catches.
2. With your thumb and index finger, gently snap in.

- Accessory Storage Box

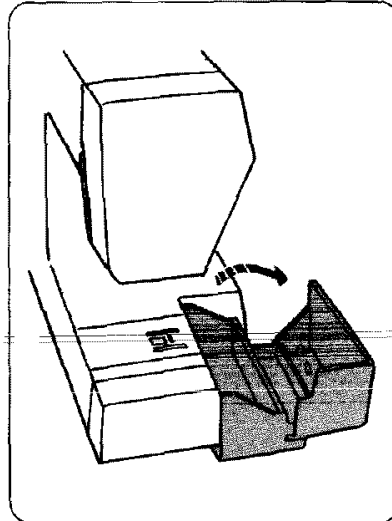

The lid of the accessory storage box lifts open toward you.

Sewing accessories are conveniently located in the box.

- Change the Presser Foot

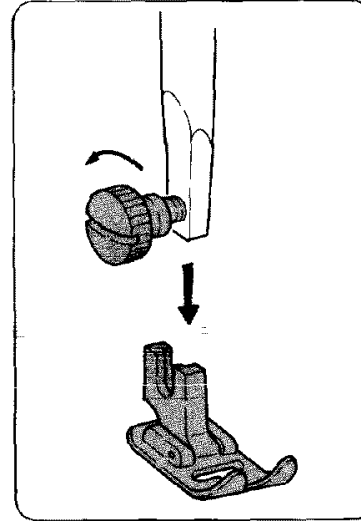

Use the correct presser foot for the stitch you wish to sew.

To change the various presser feet, raise the presser bar to its highest position by lifting the presser foot lever. Loosen the presser foot thumb screw, choose the proper foot, insert from the bottom. Tighten the screw using the large screw driver to make certain the foot is secure.

### Choose Your Needle and Thread

- To Change Your Needle

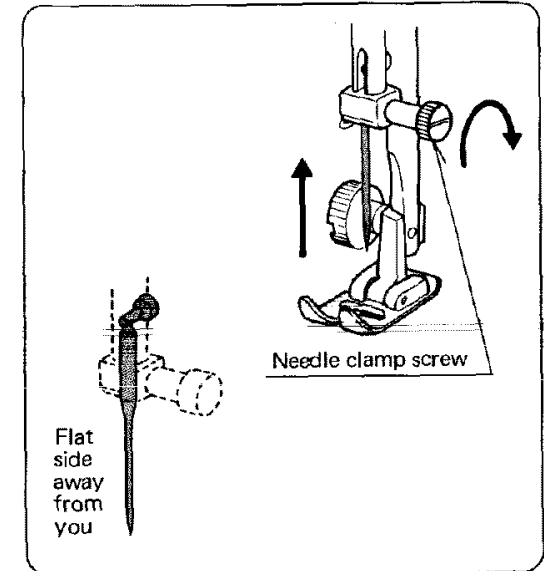

**NOTE:** Raise the needle bar to its highest position by turning the hand wheel toward you.

1. Loosen the needle clamp screw by turning it toward you.
2. Remove the needle by pulling it downward.
3. Insert the new needle into the needle clamp with the flat side away from you.
4. Push the needle up as far as it will go.
5. Tighten the needle clamp screw firmly with the large screwdriver from your accessory box.

## SECTION 2. PREPARE YOUR MACHINE FOR SEWING

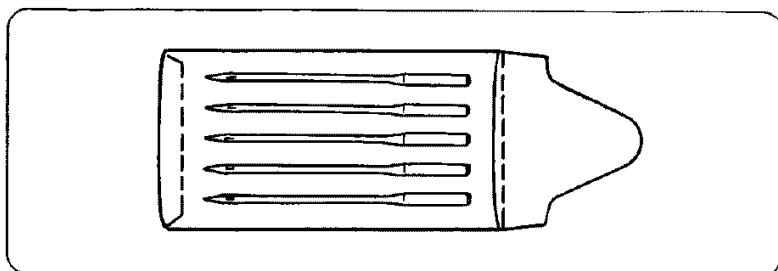

Your choice of needle and thread depends on the fabric you are sewing.

In your needle envelope, you will find the following color-coded needles:

- Blue (11) . . . . . for stretch fabrics.
- Orange (11) . . . . . for lightweight fabrics.
- Red (14) . . . . . for medium or medium-heavy weight fabrics.
- Purple (16) . . . . . for medium-heavy weight fabrics and decorative topstitching on these fabrics. (This needle has a larger thread hole for thicker topstitching thread.)
- Green (18) . . . . . for heavy weight fabrics and decorative top-stitching on these fabrics.

Replacement Kenmore needles are available at your nearest Sears stores.

### • Check Your Needle

1. Look for barbed or blunt point.
2. A damaged needle can cause permanent snags or runs in knits, fine silks and silk-like fabrics.

Always buy a good quality thread. It should resist tangling and be strong, smooth and consistent in thickness.

### • Fabric, Needle, Thread and Stitch Length Chart

FABRIC	NEEDLE SIZE AND COLOR	THREAD SIZE	RECOMMENDED STITCH LENGTH SETTING
Lightweight: Batiste, Dimity, Chiffon, Silks, Fine Lace, Organza, Crepe, Taffeta, Voile, Organdy	11-ORANGE	Polyester Core/Cotton Wrap Fine Mercerized Cotton Silk A	2 (12 stitches per inch)
Medium Weight: Cotton, Cotton Blends, Percale, Gingham, Shantung, Pique, Seersucker, Satin, Knits, Vinyl Suitings, Linen, Wool Crepe, Leather	14-RED	50 Mercerized Cotton Polyester Core/Cotton Wrap Silk A	2-2.5 (10-12 stitches per inch)
Medium Heavy Weight: Corduroy, Denim, Wool, Sailcloth, Wool Flannel, Gabardine, Velvets, Leather	14-RED or 16-PURPLE	50 Mercerized Cotton Mercerized Heavy-Duty Polyester Core/Cotton Wrap Silk A	2-3 (8-10 stitches per inch)
Heavy Weight: Coatings, Upholstery Cotton Duck, Heavy Twill, Canvas	18-GREEN	Heavy Duty Mercerized Cotton Polyester Core/Cotton Wrap Silk A	3 (8 stitches per inch)
Decorative top-stitching on all types of fabric	16 PURPLE 18-GREEN	Buttonhole Twist (Use as top thread only)	3-4 (6-8 stitches per inch)
Stretch Fabric: Polyester Double Knits, Nylon Tricot, Jersey, Stretch Terry, Spandex, Cire Tricot	11-BLUE (STRETCH FABRIC NEEDLE)	Polyester Core/Cotton Wrap 50 Mercerized Cotton	2-2.5 (10-12 stitches per inch)

## SECTION 2. PREPARE YOUR MACHINE FOR SEWING

### Prepare the Bobbin

- To Remove the Bobbin Case from the Machine

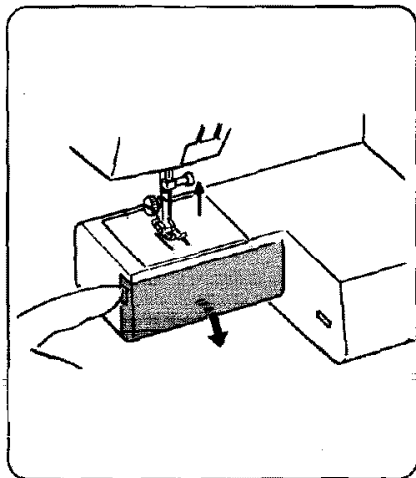

Remove the extension table from the machine by pulling it to the left. Open the shuttle cover by pulling down the embossed part on the left side of the cover.

Raise needle to its highest position by rotating hand wheel toward you.

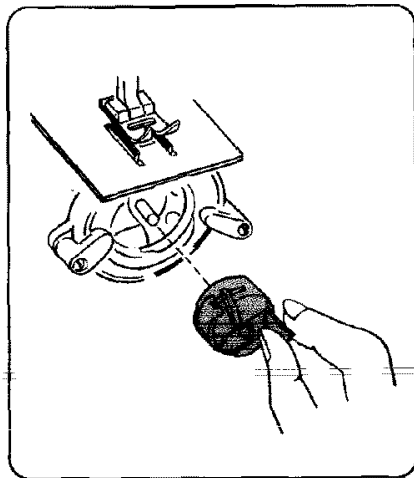

To remove bobbin case from shuttle, pull open latch of bobbin case. Pull bobbin case straight out of shuttle.

- Wind the Bobbin

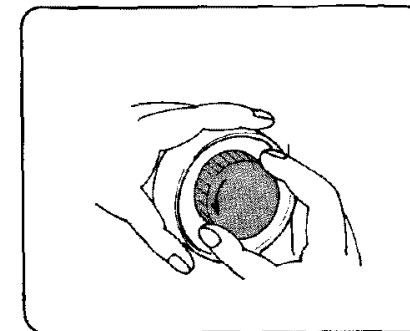
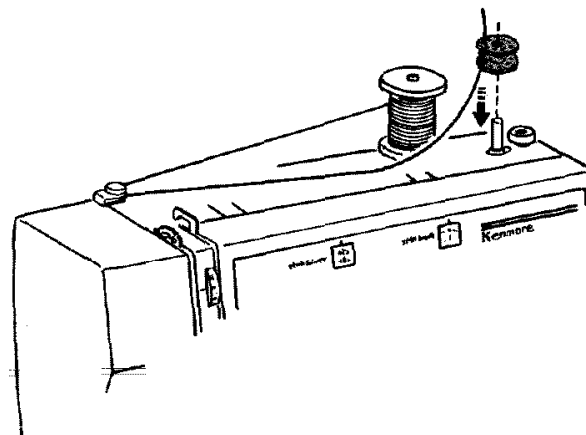

Release clutch by turning the clutch knob inside the hand wheel toward you to stop the needle from moving while you winding the bobbin.

## SECTION 2. PREPARE YOUR MACHINE FOR SEWING

### • Wind the Bobbin (Continued)

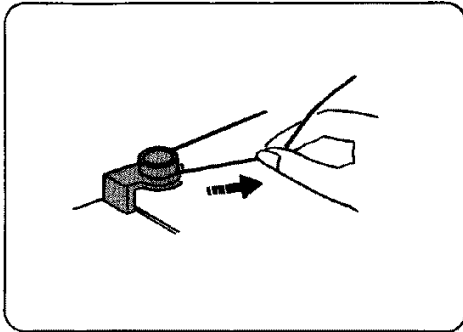

Draw thread from spool through bobbin winding tension disc as shown.

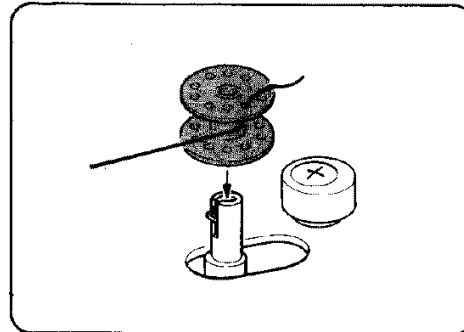

Pull end of thread through hole in bobbin as shown.

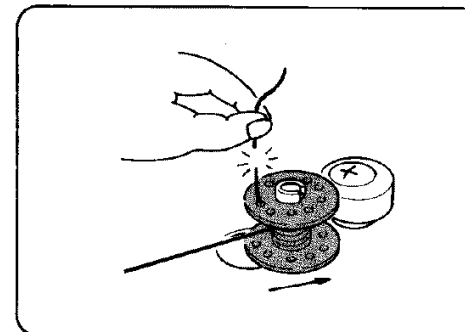

Place bobbin onto bobbin winding spindle with end of thread coming from the top of the bobbin. Push bobbin winding spindle to the right until it clicks. Holding onto end of thread, start machine. When bobbin is slightly filled, snip off end of thread.

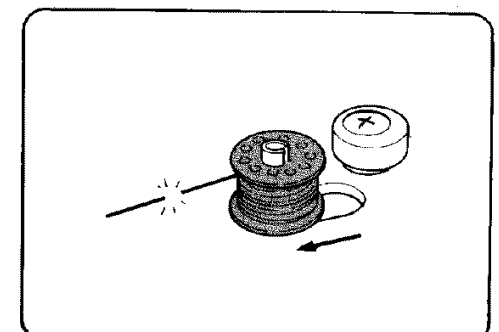

Wind thread until winder stops. Push bobbin winding spindle to the left and clip thread. Remove bobbin. Turn clutch knob away from you while holding hand wheel for normal sewing operation.

### • Insert the Bobbin into the Bobbin Case

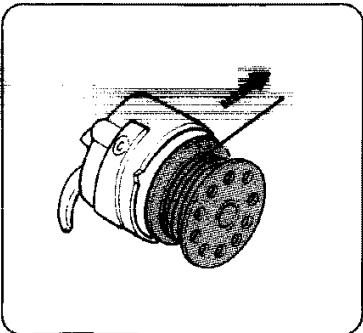

Place bobbin in bobbin case making sure thread feeds clockwise and is coming from bobbin as shown.

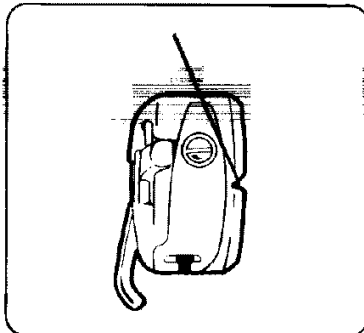

Pull thread through slot of case as shown.

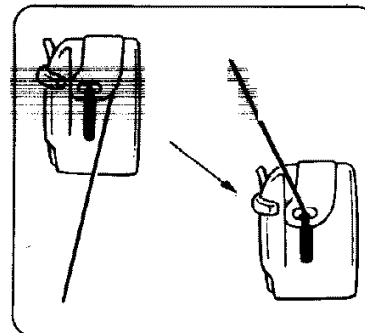

Pull thread under tension spring and through the opening as shown above. Pull 3 to 4 inches of thread from bobbin.

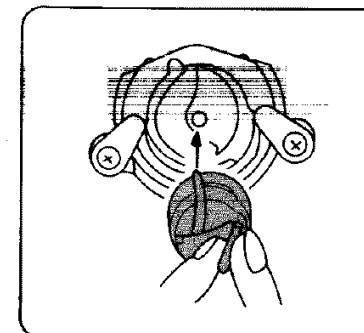

Holding latch open, position case into shuttle and release latch.

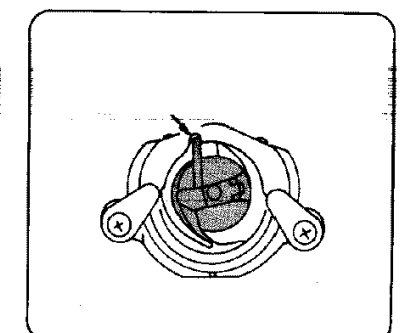

Case should lock into place when latch is released.

## SECTION 2. PREPARE YOUR MACHINE FOR SEWING

### Prepare Your Top Thread

#### • Thread Your Needle

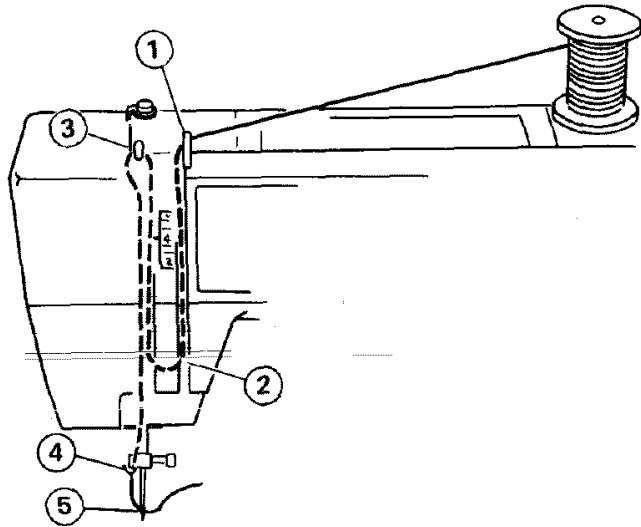

The numbered steps above follow the numbers on the illustrations.

Dotted lines show places where the thread loops and then is pulled tight.

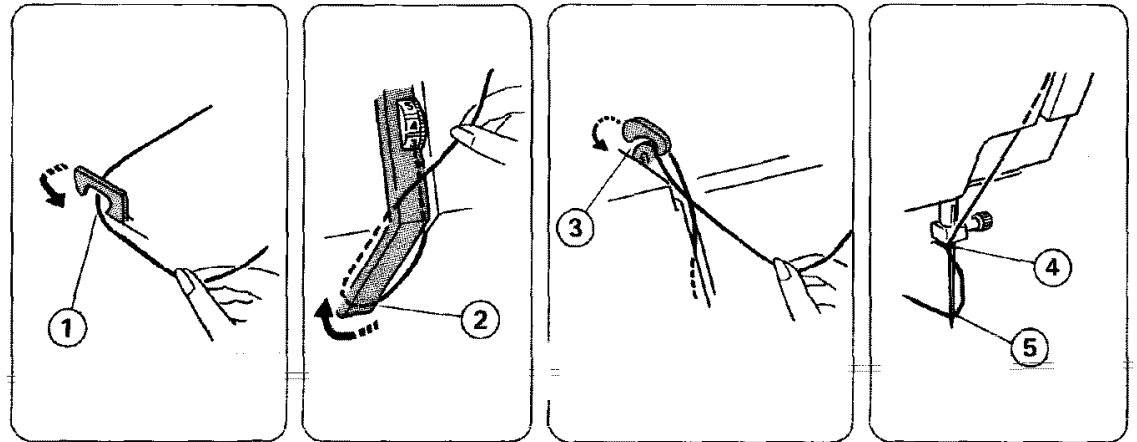

Raise take-up lever to its highest position by turning hand wheel toward you.

Raise presser foot lever.

Place spool on spool pin as shown, with thread coming from the back of the spool.

1. Draw thread into thread guide using both hands.
2. While holding thread near spool, draw thread down into the tension area and then around the check spring holder.
3. Firmly draw thread up and through take-up lever from right to left.
4. Draw thread down and slip it into needle bar thread guide.
5. Thread needle from front to back.

NOTE: You may want to cut the end of thread with sharp scissors for easier needle threading.

## SECTION 2. PREPARE YOUR MACHINE FOR SEWING

### • Pick Up Your Bobbin Thread

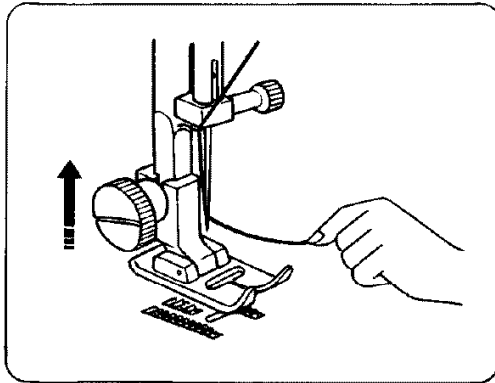

1. Raise presser foot lever. Hold top thread loosely in left hand and rotate handwheel toward you one complete turn.

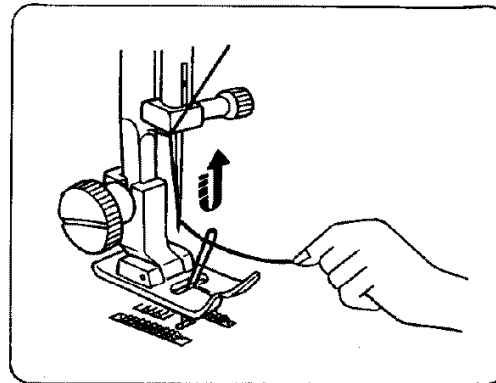

2. Bring bobbin thread up by pulling top thread.

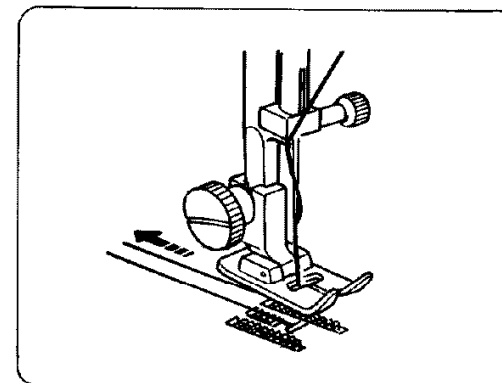

3. Pull both threads under and to the back of the presser foot, leaving 4 to 6 inches of thread clear.

If you cannot pick up bobbin thread by following steps given above, then check:

1. Is needle threaded from front to back?
2. ~~Is thread tangled around needle?~~
3. Are 3 to 4 inches of thread coming from the shuttle?
4. Is thread from shuttle tangled?
5. Is bobbin properly installed in the bobbin case?
6. Is the machine threaded according to the instructions?

## SECTION 2. PREPARE YOUR MACHINE FOR SEWING

### Adjust the Top Thread Tension

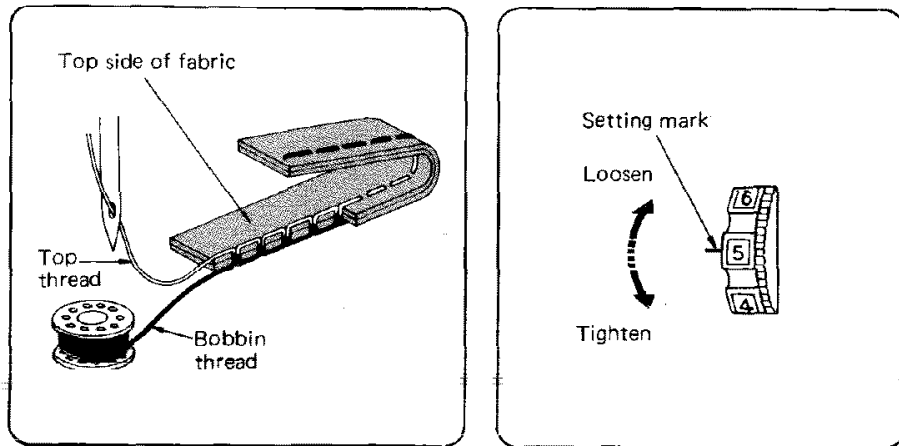

#### For Straight Stitch

The ideal straight stitch will have threads locked between the two layers of fabric, as shown above, magnified to show detail.

If you look at the stitch, front and back, you will notice that there are no gaps, that each stitch is smooth and even.

When adjusting top thread tension, the higher the number, the tighter the top thread.

Choose the Correct Tension:

The best tension will depend on;

- \_\_\_\_\_ the stiffness and thickness of the fabric
- \_\_\_\_\_ the number of fabric layers
- \_\_\_\_\_ the type of stitch

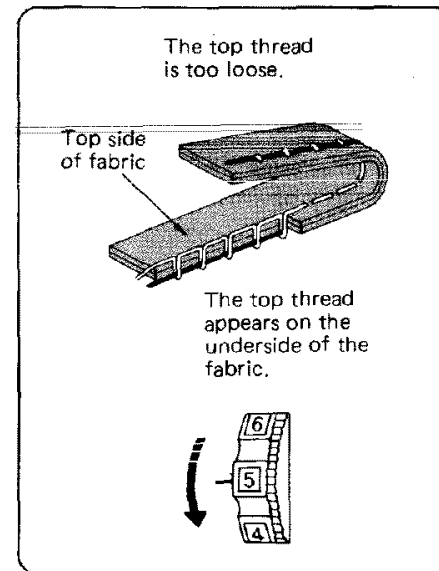

Tension is too loose:

The top thread shows through the bottom of the fabric. The bottom side of the stitch will feel bumpy.

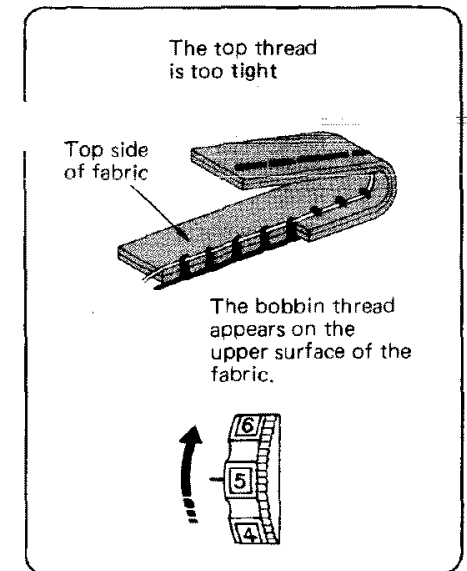



Tension is too tight:

The bobbin thread will come through the top of the fabric. The top side of the stitch will feel bumpy.

For Zigzag Stitch

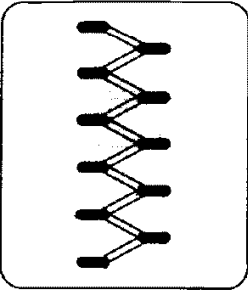
In the correct zigzag stitch, the bobbin threads will not show on the top side of fabric and the top threads will show slightly on the bottom side. See below for the correct appearance. To match this appearance, adjust your top tension.

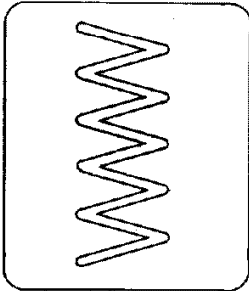
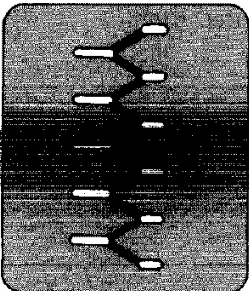
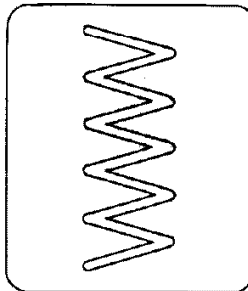
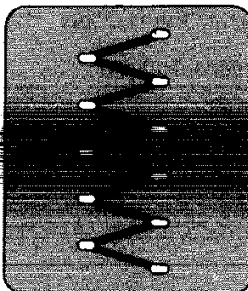
<p>Top tension <b>Too Tight</b></p>  <p>Top side of Fabric</p>  <p>Bottom side of Fabric <b>Too Tight:</b></p> <p>— Corner of each zigzag will pull together on the top side of fabrics.</p>	<p>Top tension <b>Too Loose</b></p>  <p>Top side of Fabric</p>  <p>Bottom side of Fabric <b>Too Loose:</b></p> <p>— The top thread will loop through bottom side of fabric and will be pulled almost together.</p>	<p><b>Just Right</b></p>  <p>Top side of Fabric</p>  <p>Bottom side of Fabric <b>Just Right:</b></p> <p>Minimize the amount of top thread visible on the bottom side of fabric without causing excessive puckering or causing the bobbin thread to show on the top side. Results vary with fabric, thread and sewing conditions.</p>
---	---	---

## SECTION 2. PREPARE YOUR MACHINE FOR SEWING

### Stitch Selector

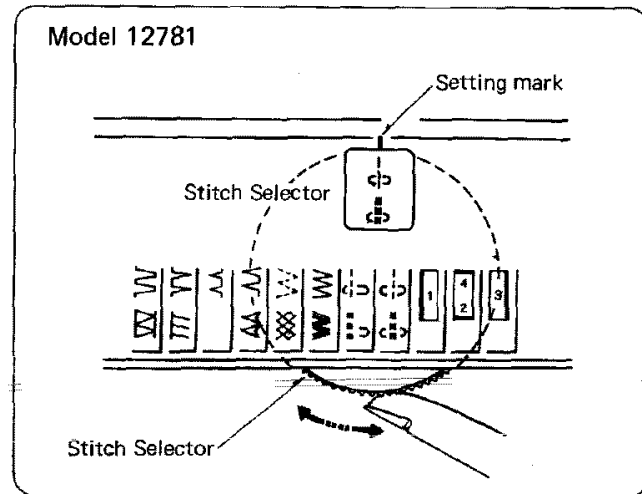

The stitch selector control not only determines the stitch you select, but also regulates the stitch width for regular zigzag and rick rack stretch stitches.

The different types of stitches are designated by color.

Straight, Zigzag and Utility Stitches are orange.

Stretch Stitches are yellow.

Buttonhole Settings are blue.

**NOTE:** To avoid needle or fabric damage, be sure your needle is up and out of fabric when adjusting this control.

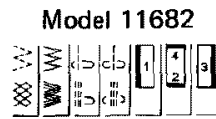
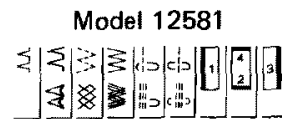
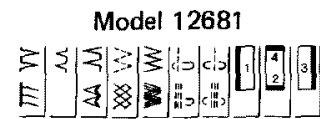

### Stitch Length Control

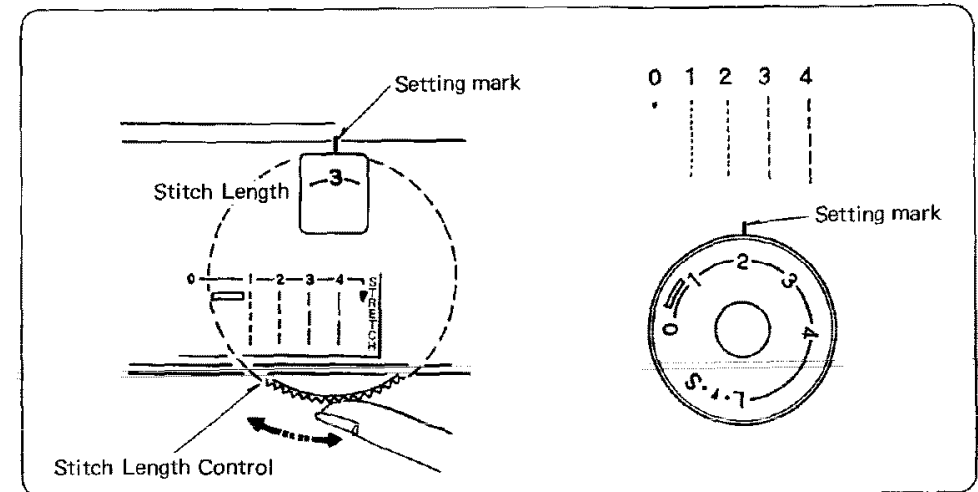

The stitch length control regulates the length of stitch, and also has a stretch stitches setting.

The higher the number, the longer the stitch.

"0" means no feed.

Depending upon your fabric or your own preference in buttonholes, you may alter the buttonhole stitch density within the blue buttonhole range on the stitch length control.

### Adjusting Stretch Stitch Balance

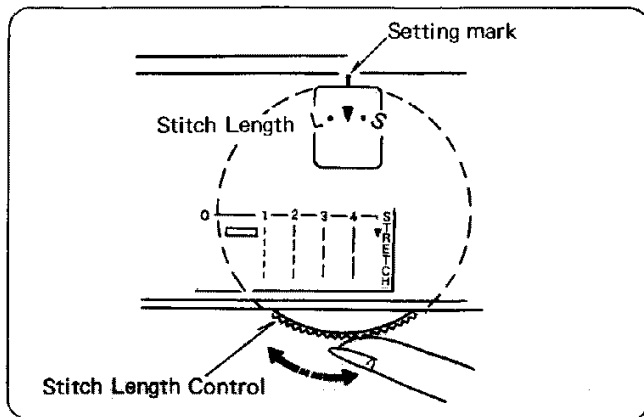

To select Stretch Stitches, set this control at ▼ position.

In stretch stitch sewing, Stitch Length Control should be in the detent position between S and L (▼ position) for most materials. Depending upon the type of fabric used, you may need to adjust this control to match forward stitches of stretch sewing with reverse motion stitches.

~~To shorten stretch stitches, turn the control slightly toward "S". To lengthen, turn toward "L".~~

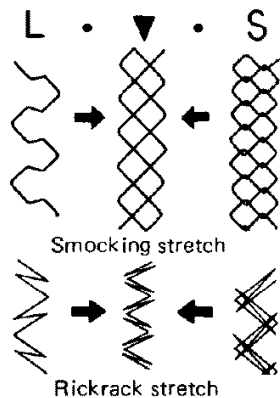

### Reverse Stitch Control

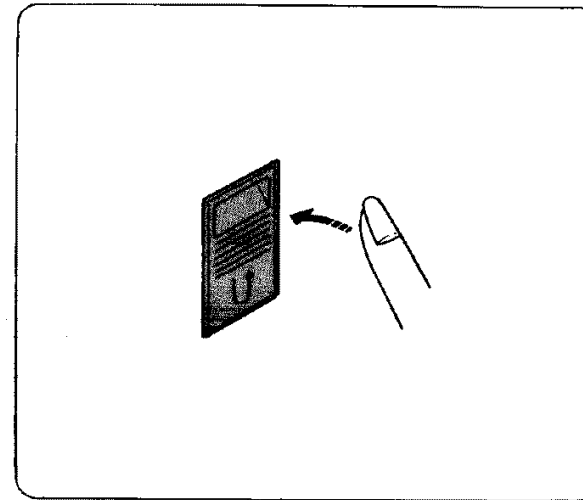

To reverse stitch, hold down this control during sewing.

Release to sew forward again.

## SECTION 2. PREPARE YOUR MACHINE FOR SEWING

### Starting To Sew

Now that you are familiar with the controls on your machine and with the accessories provided for the machine, you are ready to start to sew with your new Kenmore sewing machine. Below are some good habits to follow each time you sit down to sew:

1. Inspect the needle. It should be straight, properly set and sharp on the point. It should be the correct size for the fabric and thread being used. Do not be afraid to change your needle frequently. Many of the new fabrics made of synthetic blends tend to dull the needles more easily than fabrics made of natural fibers.
2. Before placing the material on the machine, see that the ends of the threads have been drawn about 4 inches to the rear of the machine. Hold on to threads during the sewing of the first 3 or 4 stitches of the seam.
3. Test the machine stitch on a scrap of fabric you plan to use. The fabric should be double thickness. Adjust the machine for the length of stitch and tension suitable to your fabric.
4. Fabric should be placed under the presser foot with the bulk of the material to the left of the needle and the right edge of the material placed on the 5/8" seam marking on the needle plate when making a simple seam.
5. Run the machine at a slow even speed. The more pressure you put on the foot control, the faster the machine will sew.
6. Fasten each seam by back tacking at the beginning and end of the seam.
7. Always finish sewing each seam with the needle at its highest point.
8. Guide the fabric gently with your hand in front of the needle. Never pull or hold the fabric in such a way that the normal feeding is altered.
9. When turning the hand wheel manually, always turn it toward you.

## Straight Stitches

### • Straight Stitch

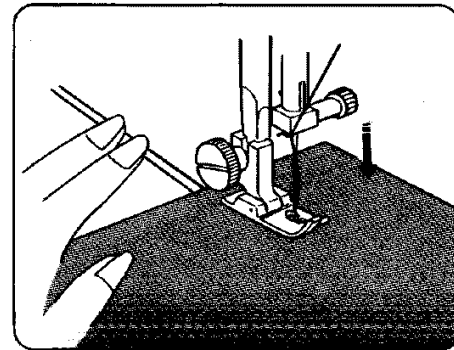
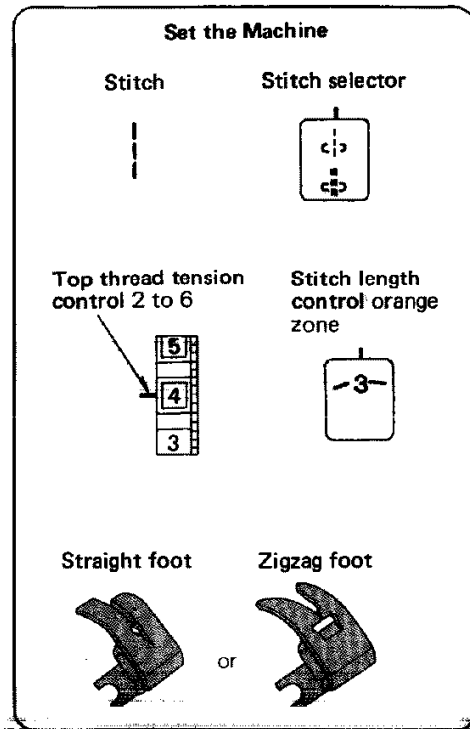

1. Raise the presser foot.
2. Raise the needle to its highest position.
3. Place the edge of the fabric next to a stitching guide line on the needle plate (5/8" is most common).
4. Draw the threads towards the back and lower the presser foot.
5. ~~Press the foot control.~~
6. Hold the fabric loosely and gently guide it along the guide line, so that it feeds naturally.  
Do not force the fabric or try to pull it tight.

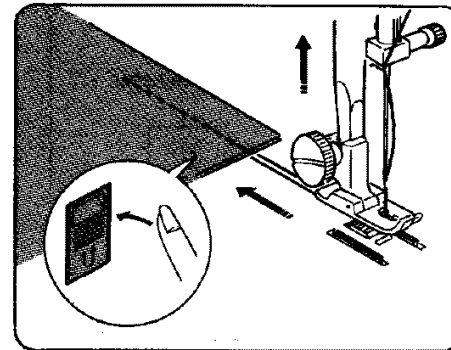

7. At the end of the seam, you may want to reverse to lock the stitch.
8. Raise the presser foot and remove the fabric.
9. Cut the threads.

### • Use the Seam Guides

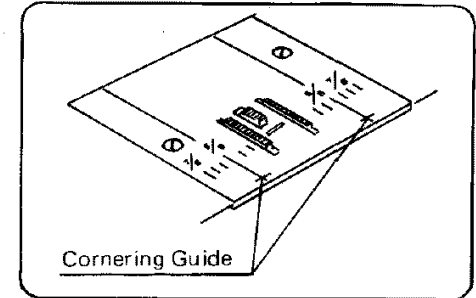

The seam guides on the needle plate are there to help you measure seam width. The lines are 1/8" apart, with the 5/8" and 7/8" lines marked.

### • Turn a Square Corner

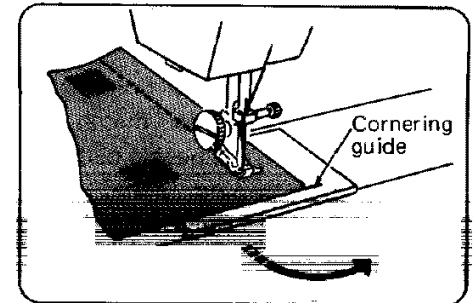

To turn a square corner 5/8" from the fabric edge:

1. Stop stitching and lower the needle by turning hand wheel toward you when the fabric edge facing you lines up with the cornering guide, as shown.
2. Raise the presser foot and turn the fabric to line the edge with the 5/8" seam guide.
3. Lower the presser foot and begin stitching in the new direction.

## SECTION 3. LEARN THE STITCHES

### Straight Stitches (Continued)

- Use the Darning Plate

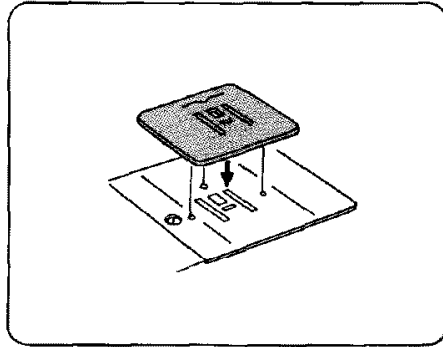

Sometimes when you sew, you want to control the fabric yourself.

The Darning Plate covers the feed dogs so that they do not touch the fabric.

To Put on the Darning Plate:







**NOTE:** The rectangular holes in the Darning Plate match the holes in the needle plate. In the darning plate, these holes are slightly to the left of center.

1. Position the darning plate with the 3 pins on the bottom.
2. Fit the darning plate pins into the needle plate holes. The feed dogs will show through the darning plate holes.

Use the darning plate in the following ways: Darning (P. 19)  
Button Sewing (P. 23)

- Topstitching

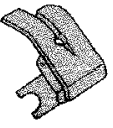
**Set the Machine**

Stitch 	Stitch selector 
Top thread tension control 2 to 6 	Stitch length control orange zone 
Straight foot 	Zigzag foot 

or

#### The Stitch and Its Uses

Topstitching emphasizes the lines of your garment and keeps seams and edges flat and crisp.

Accent suits or blouses with one or two rows of topstitching around the outer edges of cuffs, lapels or collars.

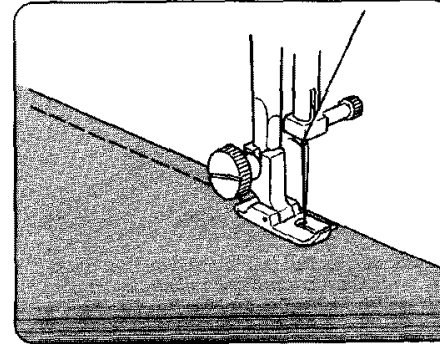

#### Here's How

1. Lower the presser foot.
2. Keep the edge of the fabric next to the right edge of the presser foot.
3. Evenly guide the fabric along this edge to produce an even row of topstitching 3/8" from the edge.

- Left Needle Position

Stitch selector  

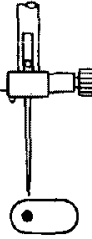

Use Left Needle Position for more control while topstitching or edge stitching difficult fabrics.

**NOTE:** Use only zigzag presser foot for Left Needle Sewing.

## Darning

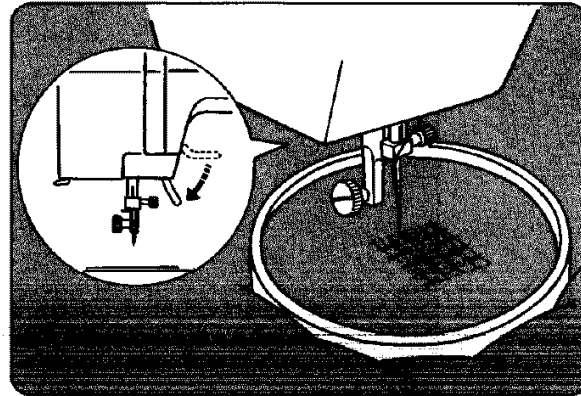
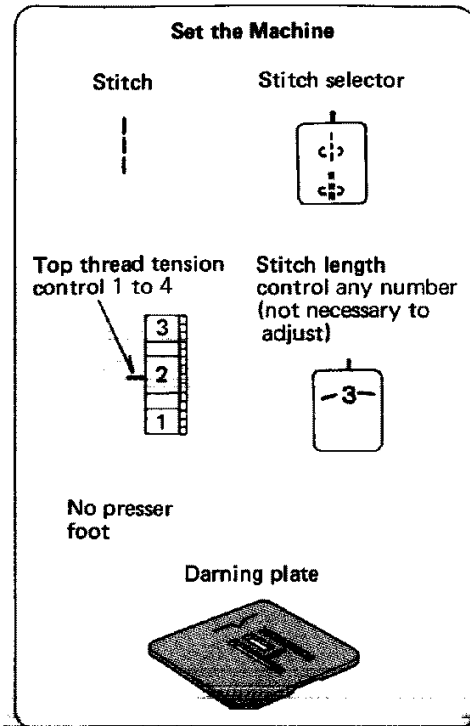
Here's How

1. Put the darning plate on the needle plate (see p. 18).
2. Remove presser foot and stretch fabric between embroidery hoops with hole centered.
3. Draw the bobbin thread up through the fabric by holding the top thread and taking one stitch at the spot where you wish to start darning.
4. Lower the presser bar and sew at a slow speed.
5. Move the fabric back and forth slowly until you have covered the darning area.
6. Turn the fabric half turn and sew another layer of stitching over the first layer.

**NOTE:** If your fabric is thin or badly damaged, use a separate piece of fabric under the hole to reinforce it.

7. When you finish darning, remove the darning plate.

## Straight Stretch

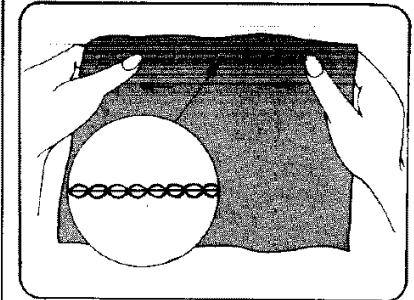
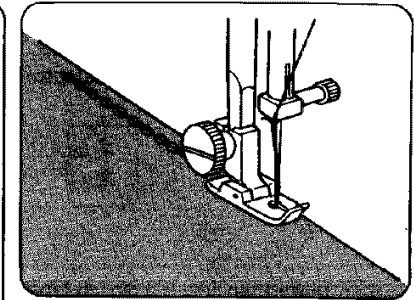
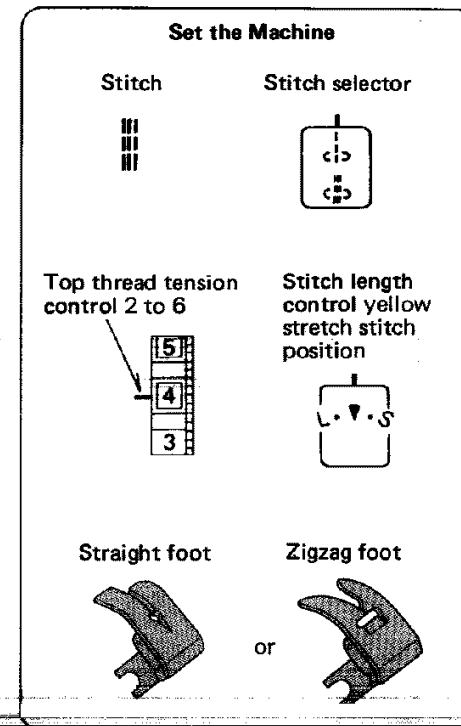

Stretch stitching was developed to be used on stretch fabrics and knits. It can be used on other

The Stitch and Its Uses

This stitch is the stretch variation of the straight stitch, especially developed for knits and stretch fabrics.

This stitch can also be used for topstitching on all fabrics.

fabrics as well. It works well on curved seams and on any garments that will receive a great deal of strain (ie. children's clothes).

The stretch stitch does not actually stretch as it is being sewn, but is stitched in a forward and back motion (sometimes called a "reverse-action" stitch), so that it will give when the fabric stretches instead of breaking.

## SECTION 3. LEARN THE STITCHES

### Zigzag Stitches

- Basic Zigzag

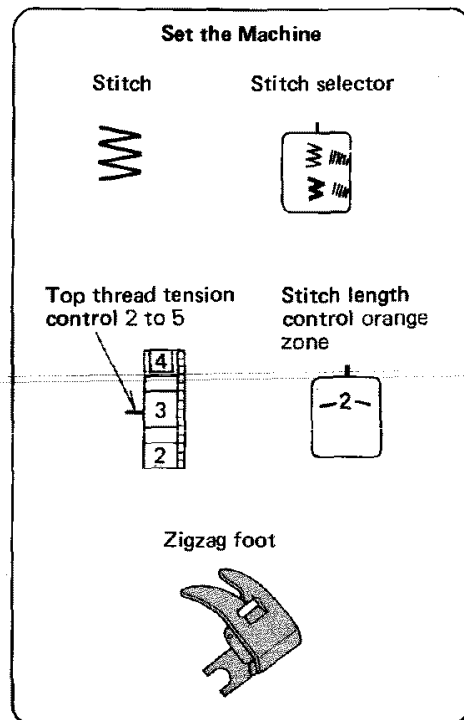

#### The Stitch and Its Uses

The zigzag stitch is one of the most common and most versatile stitches on your machine. It can be a utility stitch for sewing buttons, buttonholes, hemming, overcasting, mending and darning. It can also be used to decorate with trims, appliques and cut-out work or as a decorative stitch.

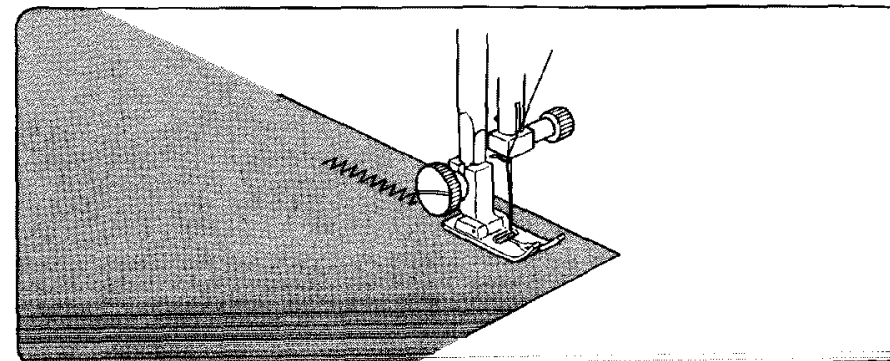

#### Here's How

There are many ways to sew a zigzag stitch.

Consult the specific variations for detailed directions.

Satin Stitch p. [21](#)

Applique Work p. [22](#)

Bar Tacking p. [22](#)

Button Sewing p. [23](#)

Overcasting p. [24](#)

Rick-rack stretch p. [24](#)

Overcast stretch p. [25](#)

Serging p. [25](#)

Three-step zigzag p. [26](#)

• **Satin Stitch**

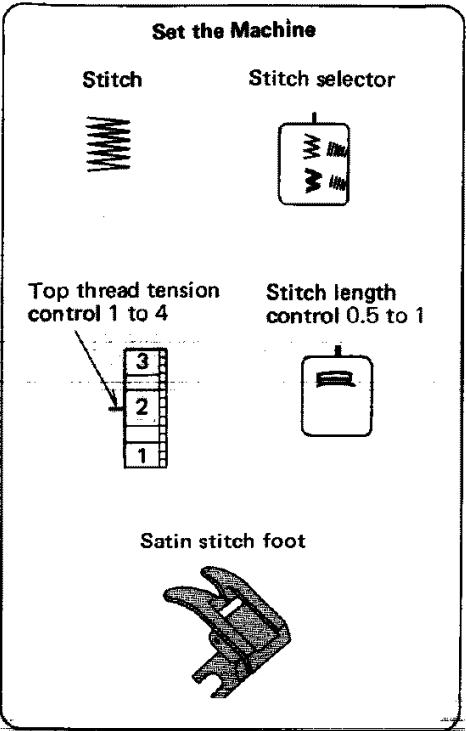

The Stitch and Its Uses

The Satin stitch is a versatile and often used decorative stitch, but it can also be used to overcast a raw edge (for example, blankets, linens, tablecloths and napkins).

The Satin stitch is especially attractive in applique.

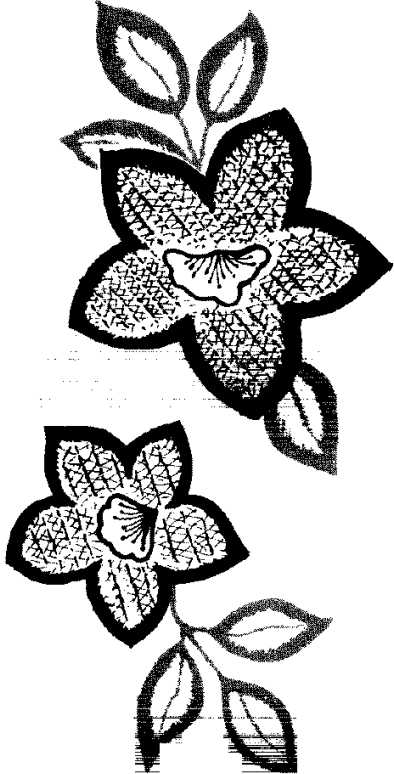
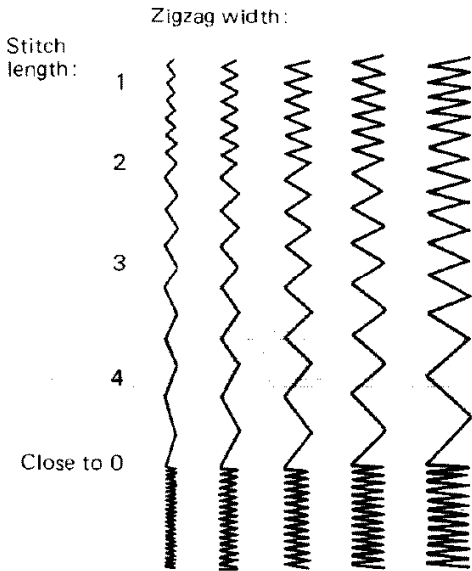

Here's How

Once your machine is set up to stitch, you may want to experiment on a fragment of the fabric you are planning to use. Too tight a satin stitch may pucker some light weight fabrics.





## SECTION 3. LEARN THE STITCHES

### Zigzag Stitches (Continued)

#### • Applique

**Set the Machine**

**Stitch** 

**Stitch selector** 

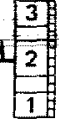
**Top thread tension control 1 to 4** 

**Stitch length control 0.5 to 1** 

**Satin stitch foot** 

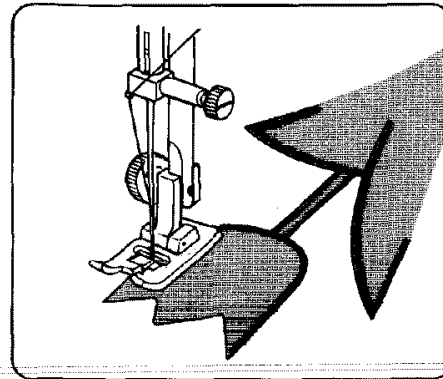



Baste (or fuse with iron-on fabric joiner) applique pieces on the fabric. Stitch around the applique making sure the needle falls along the outer edge of the applique.

When sewing corners, lower the needle down into the fabric. Raise the presser foot and pivot the fabric to the right or left.

#### • Bar Tacking

**Set the Machine**

**Stitch** 

**Stitch selector** 

**Top thread tension control 1 to 4** 

**Stitch length control 0.5 to 1** 

**Zigzag foot** 

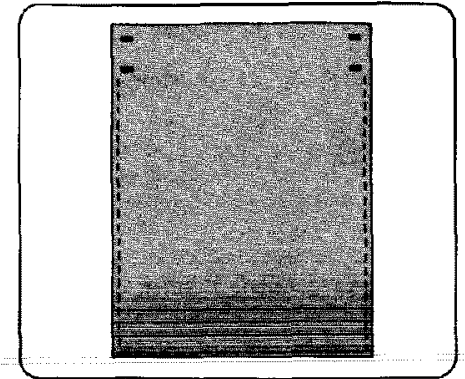





This stitch is similar to a very short satin stitch and is used to reinforce points of strain such as corners or pockets and straps on lingerie.

Sew 4 to 6 zigzag stitches.

• Sew a Button

**Set the Machine**

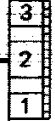

Stitch  Stitch selector 

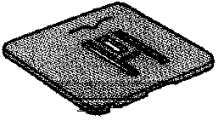
Top thread tension control 1 to 4  Stitch length control any number (not necessary to adjust) 

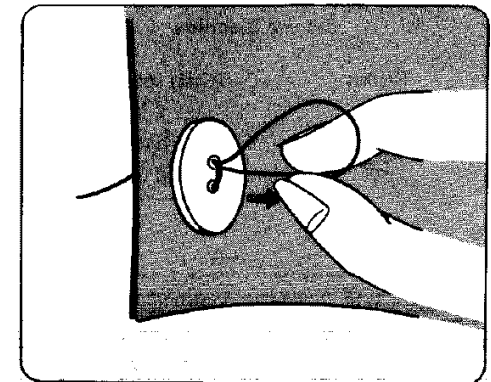
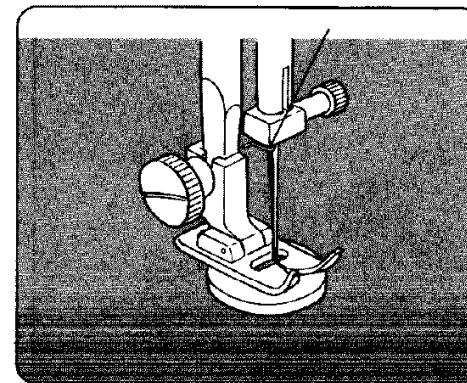
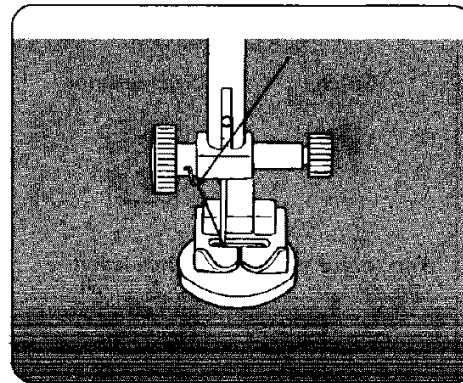
Zigzag foot  Darning plate 



Use the darning plate for button sewing (see p. 18).

1. Set the stitch selector at "  ".
2. Align the both holes of the button with the slot of the foot and place the left hole of the button just below the needle point.
3. Lower the foot and turn the stitch selector to zigzag until the needle point comes just above the right hole of the button.
4. Sew about five stitches and raise needle.
5. ~~Set the stitch selector at "  " again and sew a few stitches to lock thread.~~

To strengthen the shank, cut the threads leaving a 20 cm (8") tail. Bring the needle thread down through the hole in the button and wind it around the shank.





Draw the thread to the bottom side and knot.

## SECTION 3. LEARN THE STITCHES

### Zigzag Stitches (Continued)

#### • Overcasting Stitch

**Set the Machine**

Stitch 	Stitch selector 
Top thread tension control 1 to 4 	Stitch length control 1 to 2 

Zigzag foot  

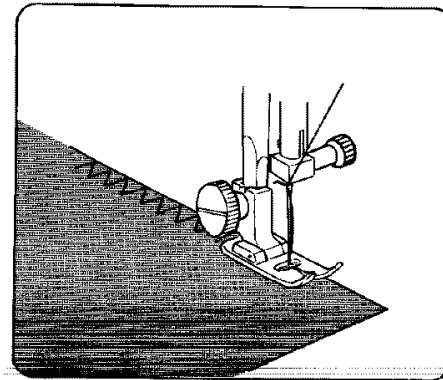

#### Helpful Hints





Start overcasting about 1/8" inside the raw corner of your seam. If you start right at the edge, the fabric will bunch up and the stitches will become tangled.

#### The Stitch and Its Uses

This zigzag variation is very useful in garment construction and in finishing raw edges of any sewing project.

#### • Rick-Rack Stretch

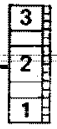
**Set the Machine**

Stitch 	Stitch selector 
Top thread tension control 1 to 4 	Stitch length control yellow stretch stitch position 

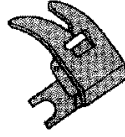
Zigzag foot  

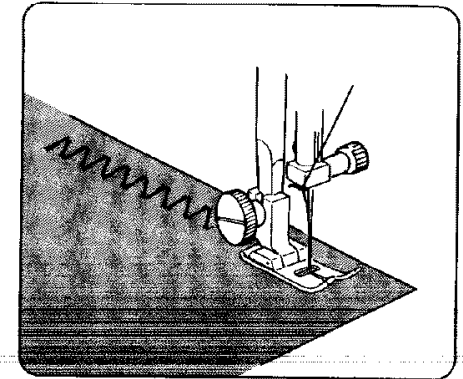



#### The Stitch and Its Uses



Sew on stretch fabrics in any area that you might use a zigzag stitch.

This stitch can be used as a decorative top stitch as well.

• Overcast Stretch Stitching (Models 12781, 12681 and 12581)

**Set the Machine**

Stitch       Stitch selector 

Top thread tension control 1 to 4       Stitch length control yellow stretch stitch position 

Zigzag foot 

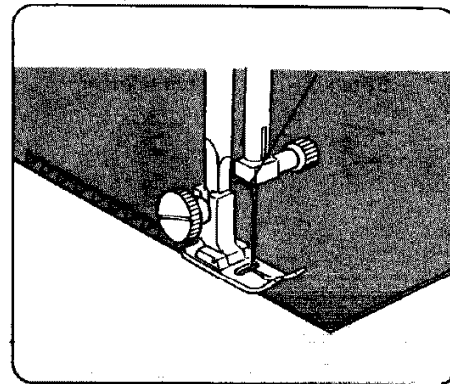

**Here's How**

Place the raw edge of the fabric to the LEFT of the needle as shown.

Stitch so the needle pierces the fabric just short of the outside edge.

Or, place your fabric to allow a 5/8" seam, then trim seam allowance after.

~~Raw or worn edges of older garments can be overcast to prevent further raveling.~~



NOTE: Use a blue stretch fabric needle, which effectively prevents skipped stitches.



**The Stitch and Its Uses**

This stitch can be used for sewing a seam with an overcast finish. The seam is formed and finished in one operation. It can be used when you are making swimwear, ski pants and other garments that require stretch.

• Serging or Pine Leaf Stretch Stitching (Models 12781 and 12681)

**Set the Machine**

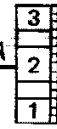
Stitch       Stitch selector 

Top thread tension control 1 to 4       Stitch length control yellow stretch stitch position 

Zigzag foot 

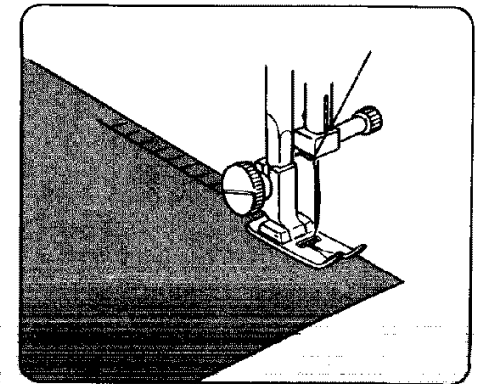

**Here's How**

Place the fabric under the presser foot so that the stitches are made over the edge.

Or, place your fabric to allow a 5/8" seam, then trim seam allowance after.

NOTE: ~~When using stretch knit fabric, use a blue stretch fabric needle which effectively prevents skipped stitches.~~

**The Stitch and Its Uses**

Use this stitch when you want a narrow seam that you do not need to press open flat. It is ideal for 1/4" seams on knits or on medium to heavyweight woven fabrics where you want a narrow seam. It is also great for making elastic swim wear.

## SECTION 3. LEARN THE STITCHES

### Zigzag Stitches (Continued)

#### • Three-Step Zigzag

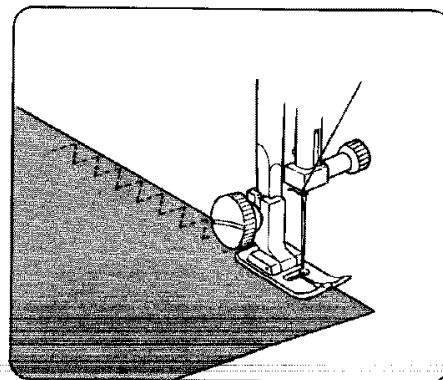
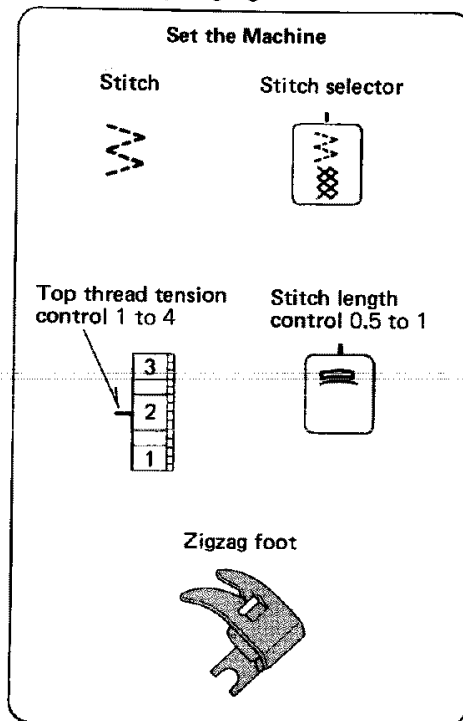

#### Seam Finishing

Place the fabric under the presser foot so that the edge will be slightly inside the right hand side of the presser foot.

Guide the work so the right hand stitches fall at the edge of the fabric.

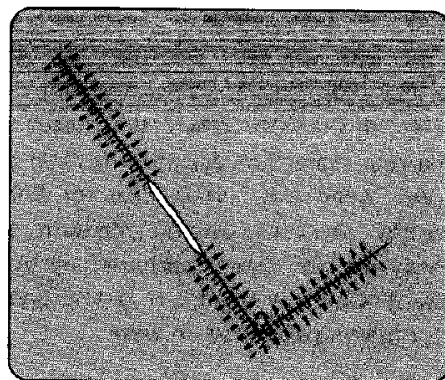

#### Mending

Position the tear under the needle so that the stitching will catch both sides.

#### The Stitch and Its Uses

The three-step zigzag is a combination zigzag and straight stitch. You may use the three-step zigzag everywhere you would use the basic zigzag stitch. It has more strength, elasticity, and is flatter than a regular zigzag.

The three-step zigzag stitch is especially useful for:

- mending
- sewing patches smoothly and securely.
- repairing straight tears.
- finishing seams.

### Lace Work (Models 12781, 12681 and 12581)

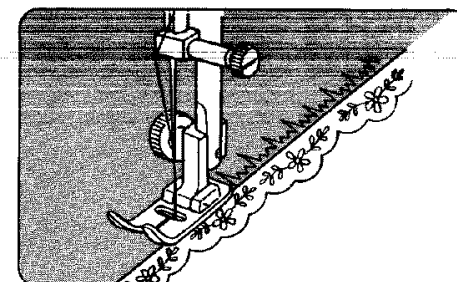
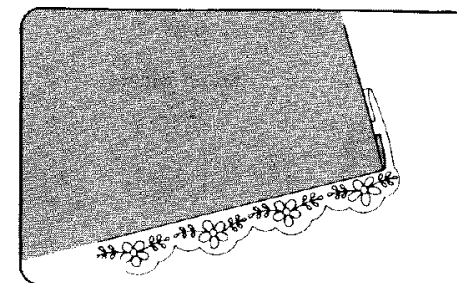
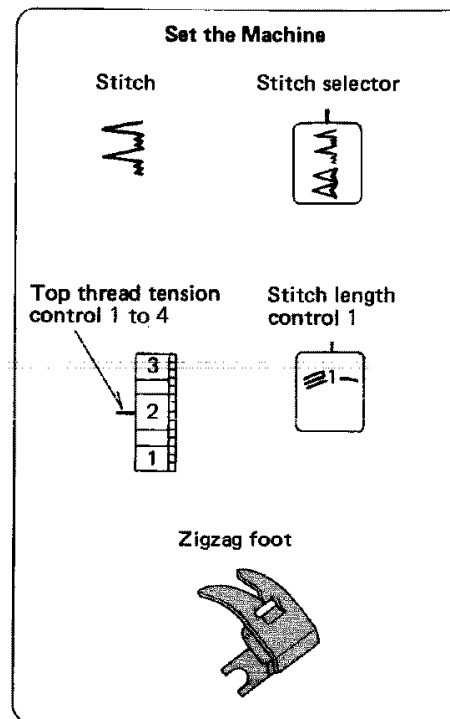



Lace adds a fanciful, feminine touch to blouses and lingerie. Table linens and pillows become more elegant when trimmed with lace.

Turn raw edge of fabric under at least 1/2". Place lace underneath and top-stitch using stretch blind hem stitch.

Trim excess fabric close to stitching.

Blind Hemming (Models 12781, 12681 and 12581)

**Set the Machine**

Stitch  Stitch selector 

(Regular)

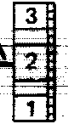
Top thread tension control 1 to 4 

Stitch length control 1 to 3 

 Zigzag foot

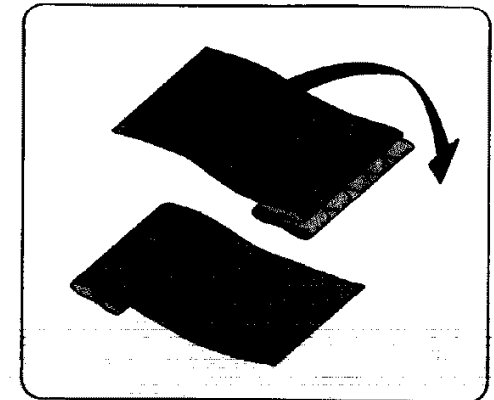
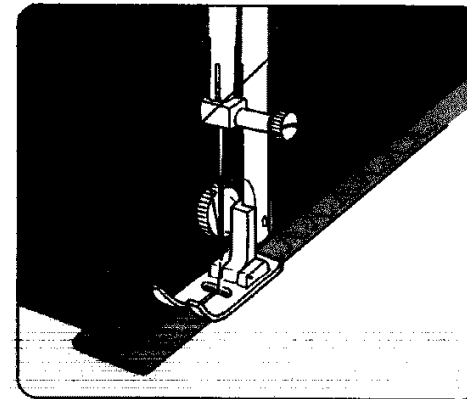
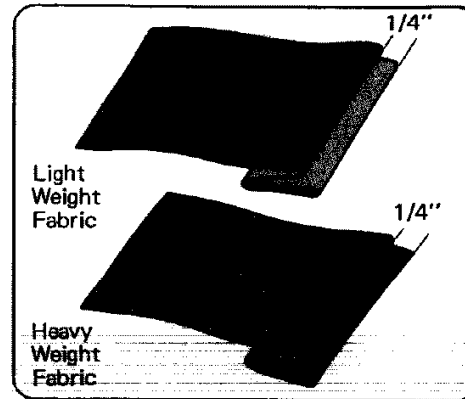

There are two blind hem stitches on your machine. The regular blind hem is used for woven fabrics. The stretch blind hem is wider and will "give" and is used for knit and stretch fabrics.



1. Finish the raw edge of your hem any way you desired. (See Overcasting, p. 24)
2. Measure, turn up your hem and pin.

NOTE: For light weight fabrics, you may need a double fold.

3. Fold the material (wrong side out) on the edge to be stitched, as shown, leaving 1/4" of the finished hem edge showing.
4. Place garment under presser foot in such a manner that straight stitches will be sewn on extended edge. The zigzag stitch should just catch the fold of the garment.
5. After hemming, press both sides of the finished hem. The top side of the garment will show only the blind stitches.

NOTE: The stretch blind hem stitch also can be used for Lace Work. (See p. 26)

**Set the Machine**

Stitch  Stitch selector 

(Stretch)

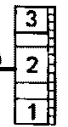
Top thread tension control 1 to 4 

Stitch length control 1 to 3 

 Zigzag foot

## SECTION 3. LEARN THE STITCHES

### Buttonholes

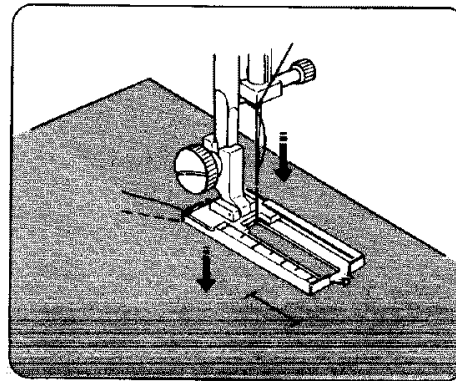
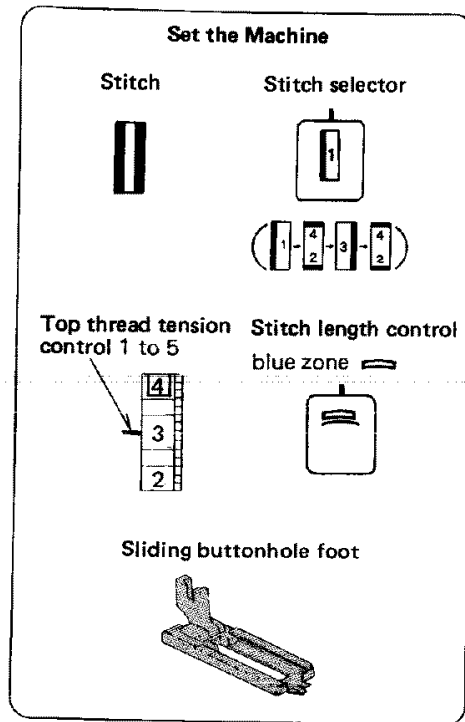

1. a. Carefully mark the buttonhole length on your garment.
- b. Change to the sliding buttonhole foot.
- c. Insert the garment under the foot with the buttonhole marking running toward you.

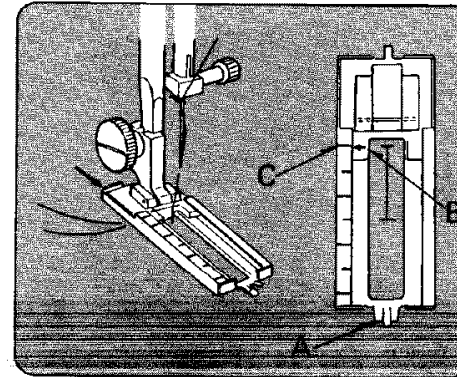

2. a. Move the slider (A) toward you so that the top mark (C) on the slider meets the start mark (B).
- b. Line up the markings on the foot with the top mark on your garment.
- c. Lower the presser foot.

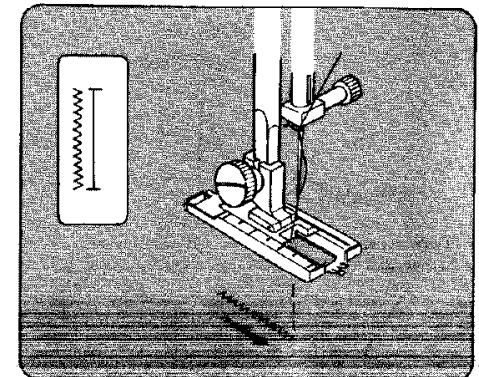

3. a. Set the stitch selector at 1.
- b. Sew forward until you reach the front marking of your buttonhole.
- c. Stop sewing at the left stitch.

**NOTE:** The markings on the slider are engraved in centimeters.

#### Adjusting the Stitch Density

Depending upon your fabric or your own preference in buttonholes, you may alter the buttonhole stitch density within the blue buttonhole range on the stitch length dial.

- ① For more density, turn the dial toward "0".
- ② For less density, turn the dial toward "1".

**NOTE:** Always make a practice buttonhole on a scrap of fabric you plan to use to find the more suitable stitch length.

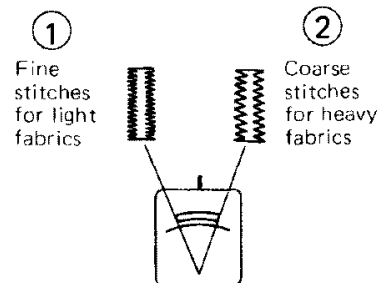

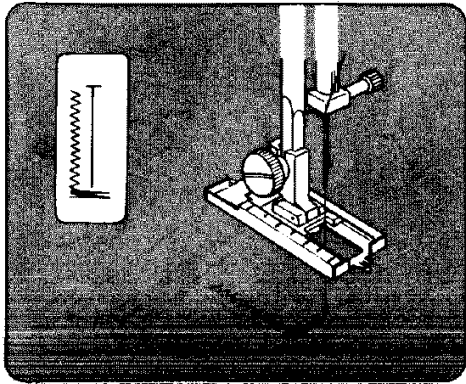

4. a. Set the stitch selector at  $\frac{4}{2}$ .
- b. Sew 4 to 6 stitches.
- c. Stop sewing at the right stitch.

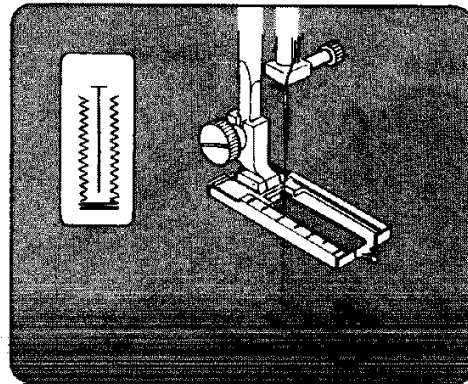

5. a. Set the stitch selector at  $\frac{3}{}$ .
- b. Sew until you reach the back marking of the buttonhole.
- c. Stop sewing at the right stitch.

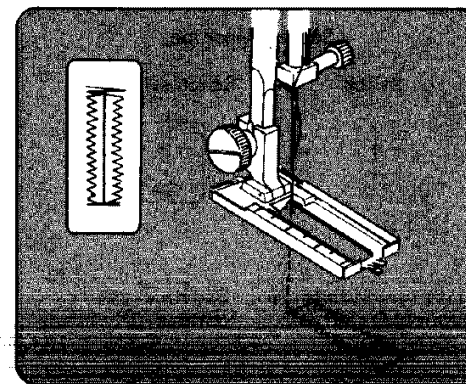

6. a. Set the stitch selector at  $\frac{4}{2}$ .
- b. Sew 4 to 6 stitches.
- c. Stop sewing at the left stitch.

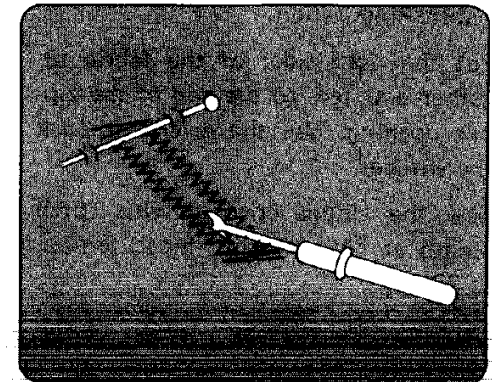

7. Remove the fabric and cut the hole open with the buttonhole opener.

**NOTE:**

When sewing at the edge of fabric, set sliding buttonhole foot as illustrated and sew in reverse (  $\frac{3}{}$  →  $\frac{4}{2}$  →  $\frac{1}{}$  →  $\frac{4}{2}$  ).

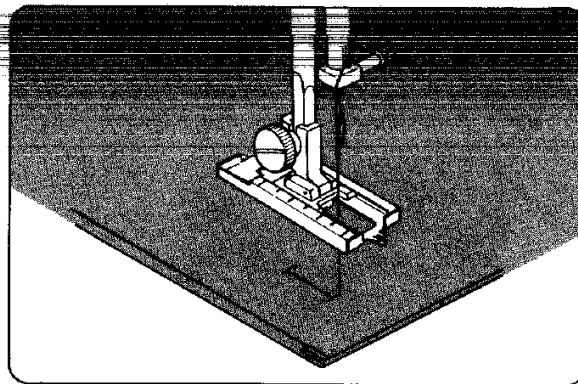

## SECTION 3. LEARN THE STITCHES

### Sew in a Zipper

#### Fabric Preparation:

Put the right sides of the fabric together and sew to the end of the zipper opening. Use the reverse to lock the stitches.

Sew the zipper opening with stitch length at "4" and top thread tension at "3".

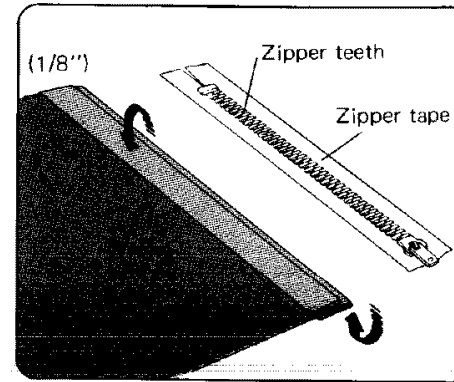
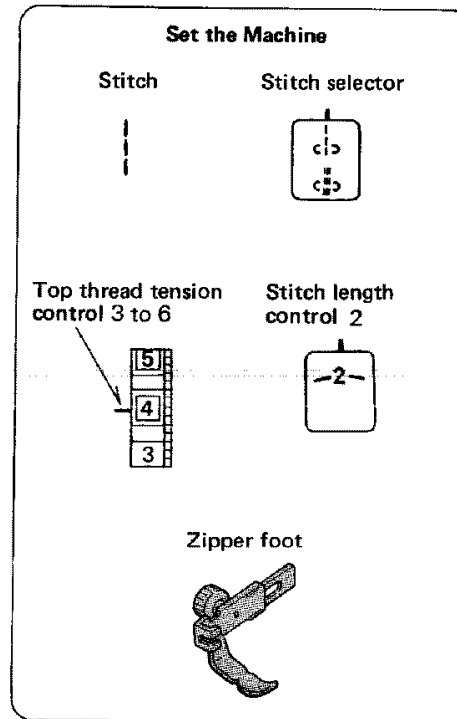
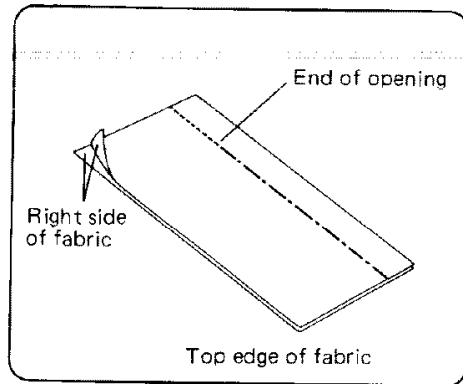

#### To Sew:

1. Fold back the left seam allowance as shown.
2. Turn under the right seam allowance to form a  $1/8"$  fold.
3. Place the zipper teeth next to the  $1/8"$  fold and pin in place.

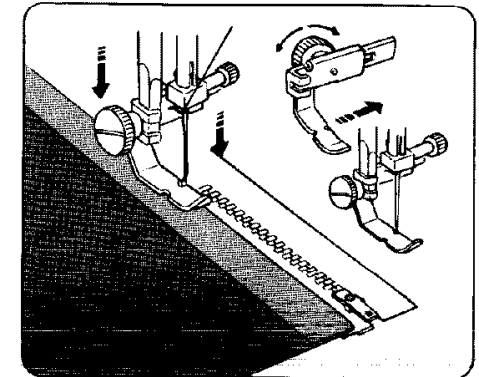

4. To sew the left side of the zipper, set the zipper foot on the left side of the needle.
5. Lower the zipper foot on the right side at the bottom of the zipper so that the needle pierces the fold and the zipper tape.
6. Sew through the fold and the zipper tape to the point where the slider begins.
7. Lower the needle to hold the fabric and raise the presser foot.

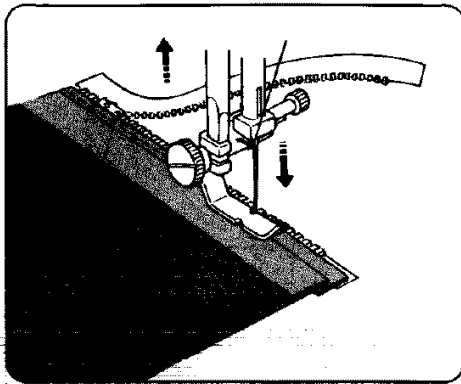

8. Open the zipper.

9. Lower the presser foot and stitch the rest of the seam.

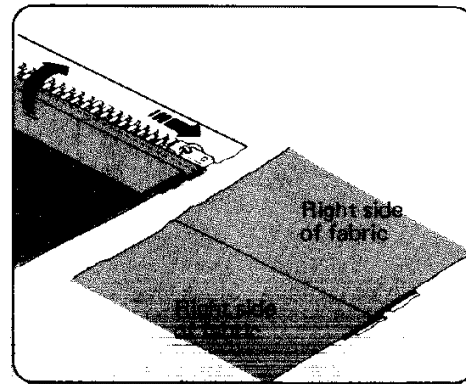

10. Close the zipper and turn the fabric right side up.

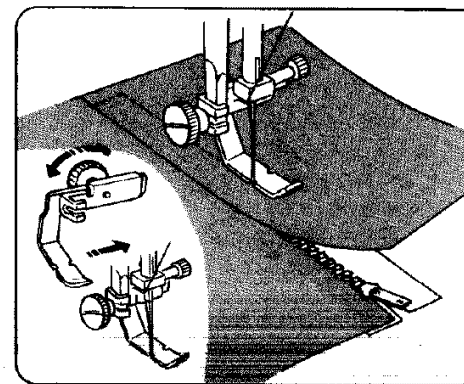

11. To sew the right side of the zipper, set the zipper foot on the right side of the needle.

12. Stitch across and below the bottom of the zipper.

13. Turn the corner and continue to guide the foot along the zipper teeth, as shown.

Stitch through the fabric and zipper tape.

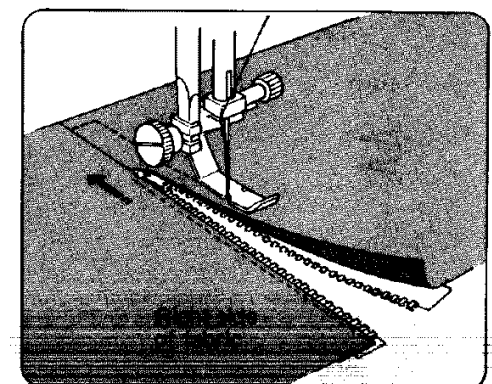

14. Stop about 2" from the top of the zipper.

15. Lower the needle into the fabric and raise the presser foot.

16. Remove the basting stitches and open the zipper.

17. Lower the foot and stitch the rest of the seam. Make sure the fold is even.

### INVISIBLE ZIPPER AND CORDING

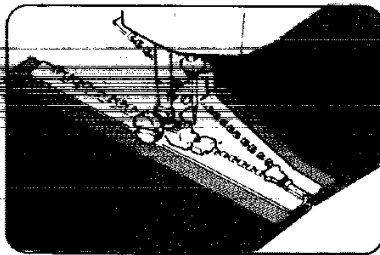

#### INVISIBLE ZIPPER

Adjust the foot so the needle is sewing through the center hole of the foot and one groove of the foot is riding on the teeth of the zipper as shown. Follow the zipper manufacturer's instructions. After zipper has been inserted, finish sewing seam by shifting foot to side position sewing through side notch.

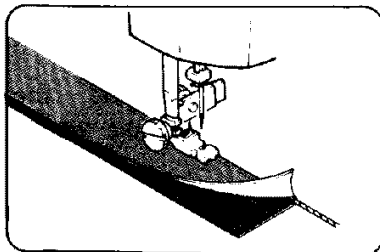

#### CORDING

Foot can also be used to make cording for slip-covers etc. Cover a cord with a strip of bias fabric and sew as shown.

#### NOTE:

Use "Low Bar Sewing Machine ZIPPER FOOT" (6757) for "invisible zipper" and "cording", which can be obtained at any Sears retail store.

## SECTION 3. LEARN THE STITCHES

### Shell Stitching (Models 12781 and 12681)

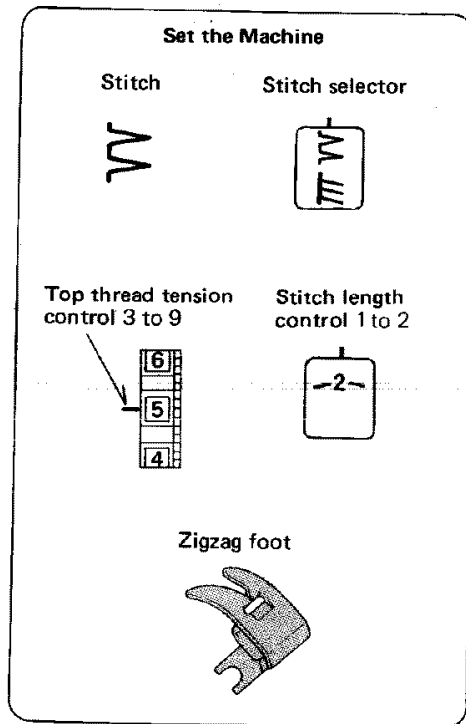

#### The Stitch and Its Uses

The Shell Stitch is formed by sewing a blind hem over folded fabric. Several rows of shell stitching are called shell tucks.

Shell stitching can be used to finish hems, sleeve and neck openings.

Shell tucking can be used to create scalloped tucks on blouses and lingerie.

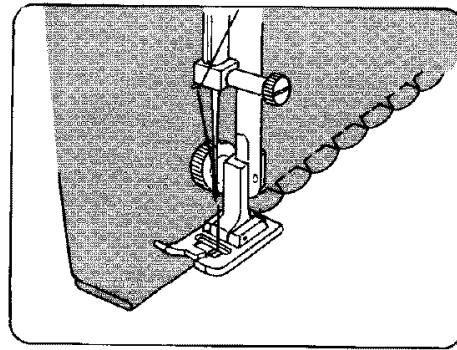

#### Here's How

- For best effect:
  - set the stitch length as you desire.
  - you may need to tighten the top thread tension slightly.
  - allow the needle to just clear the folded edge of the fabric when it zigzags.
- If you sew rows of shell stitches, space the rows 1/2" apart.

You can sew Shell Stitch on knits or soft silky wovens in any direction.

### Smocking

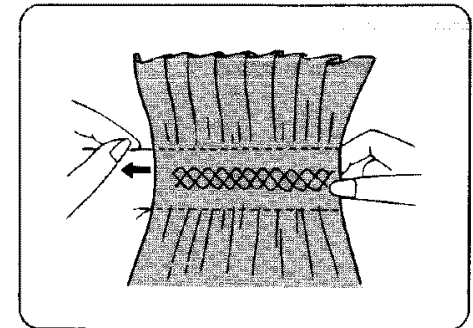
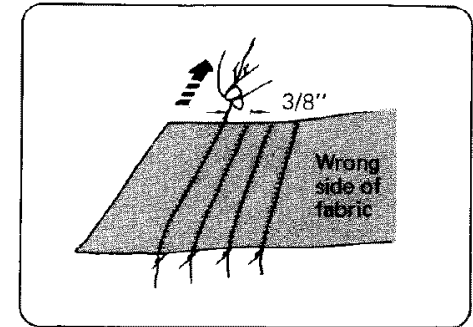
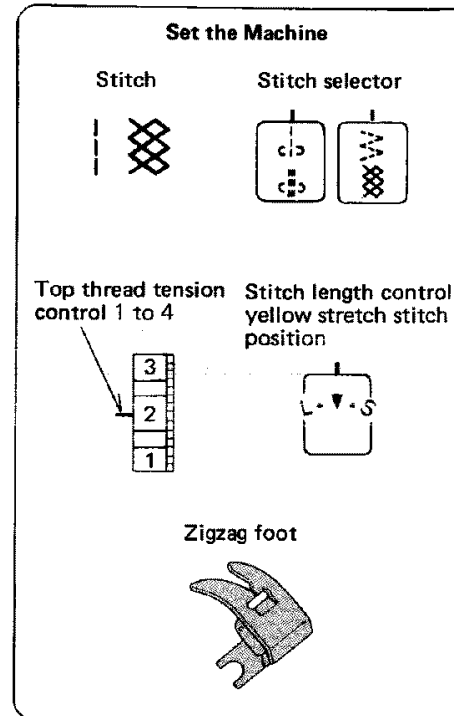

With the stitch length at "4", sew straight stitching lines 3/8" apart across the area to be smocked.



Knot the threads along one edge. Pull the bobbin threads and distribute the gathers evenly. Secure the threads at the other end. Sew the decorative stitch between the gathering stitches. Pull out the gathering stitches.



NOTE: Loosen the top thread tension to make gathering easier.

Elastic Stretch Stitch (Model 12781 only)

Box Stitching (Model 12781 only)

**Set the Machine**

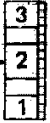
Stitch  Stitch selector 

Top thread tension control 1 to 4  Stitch length control yellow stretch stitch position 

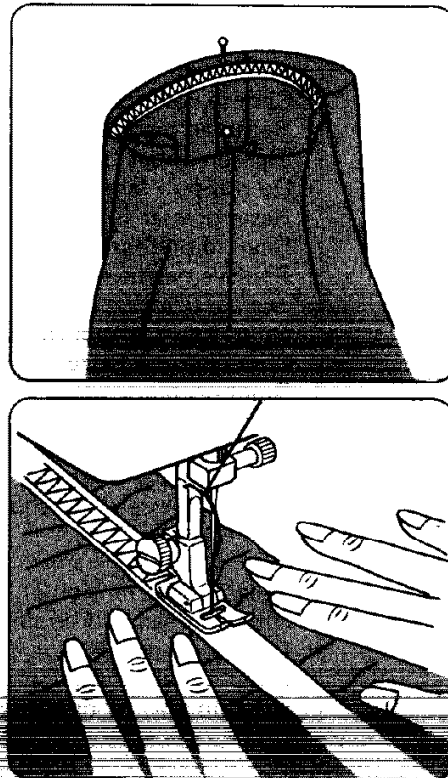

Zigzag foot 





Choose this stitch to attach elastic to garments.

1. Mark the elastic into quarters and match these to the center front, center back and side seams.
2. Place the middle of the elastic under the center of the presser foot and stitch into place, making sure the fabric is evenly distributed.

**Set the Machine**

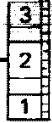
Stitch  Stitch selector 

Top thread tension control 1 to 4  Stitch length control 1 

Zigzag foot 

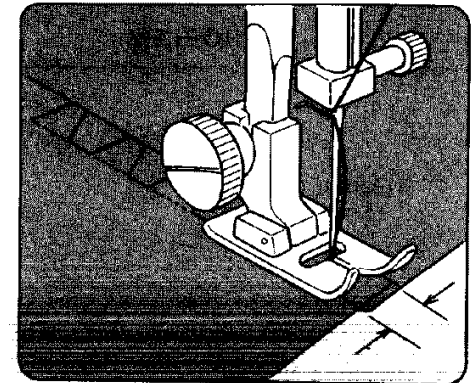

Use this stitch to join heavy weight interlining.

Overlap two raw edges together and use this stitch to join them.

## SECTION 4. PERFORMANCE PROBLEMS CHART

### What to Do When

PROBLEM	PROBABLE CAUSE	CORRECTION
Irregular Stitches	Incorrect size needle. Improper threading. Loose upper thread tension. Pulling fabric. Loose presser foot. Unevenly wound bobbin. Nicks or burrs at hole of needle plate.	Choose correct size needle for thread and fabric. Rethread machine. Tighten upper thread tension. Do not pull fabric; guide it gently. Reset presser foot. Rewind bobbin. Replace needle plate, or polish off burrs completely.
Breaking Needle	Pulling fabric. Incorrect size needle. Incorrect setting of needle. Loose presser foot.	Do not pull fabric; guide it gently. Choose correct size needle for thread and fabric. Reset needle. Reset presser foot.
Bunching of Thread	Upper and lower threads not drawn back under presser foot before starting seam.	When starting a seam be sure to draw both threads under and back of presser foot about 4" and hold until a few stitches are formed.
Puckering	Incorrect thread tension(s). Using two different sizes or kinds of thread. Bent or blunt needle. Loose presser foot. Fabric very sheer or very soft.	Reset thread tension(s). Upper thread and bobbin thread should be same size and kind. Insert new needle. Reset presser foot. Use underlay of tissue paper.

SECTION 4. PERFORMANCE PROBLEMS CHART

What to Do When (Continued)

PROBLEM	PROBABLE CAUSE	CORRECTION
Skipping Stitches	Incorrect size needle. Bent or blunt needle. Incorrect setting of needle. Tight upper thread tension.	Choose correct size needle for thread and fabric. Insert new needle. Reset needle. Loosen upper thread tension.
Breaking Upper Thread	Starting to stitch too fast. Improper threading. Tight upper thread tension. Incorrect size needle. Sharp eye in needle. Nicks or burrs on shuttle. Nicks or burrs at hole of needle plate.	Start to stitch at a medium speed. Rethread machine. Loosen upper thread tension. Choose correct size needle for thread and fabric. Insert new needle. Replace shuttle, or polish off burrs completely. Replace needle plate, or polish off burrs completely.
Breaking Bobbin Thread	Improper bobbin case threading. Lint in bobbin case or shuttle.	Check bobbin case threading. Clean bobbin case and shuttle.
Fabric not Moving	Darning plate in place. Stitch Length set at 0. Thread knotted under fabric.	Remove darning plate. Adjust Stitch Length Control. Place both threads back under presser foot before beginning to stitch.
Machine Jamming Knocking Noise	Thread caught in shuttle. Lint in bobbin case or shuttle.	Disassemble and clean shuttle. Clean bobbin case and shuttle.



## SECTION 5. CARE FOR YOUR MACHINE

### Replacing the Light Bulb

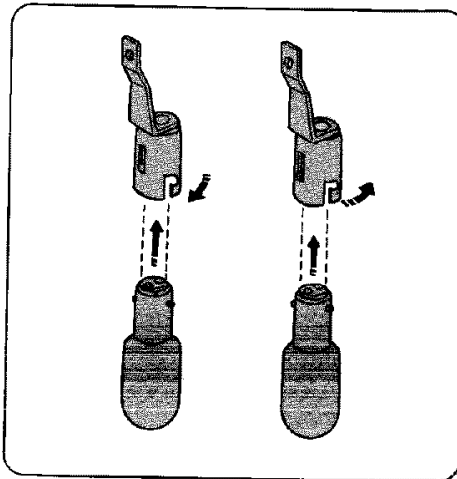

1. Unplug the machine and open the face cover.

**CAUTION!** The light bulb will be HOT. Protect your fingers when you handle it.

2. Push the bulb up and turn the bulb counter-clockwise to remove it.
3. Put the new bulb in by pushing it up and turning it clockwise.

### Cleaning the Machine

To insure that your machine operates at its best, you need to keep the essential parts clean at all times. The feed dogs and shuttle race areas can attract dust and lint. Your machine can become sluggish or knock loudly if a thread is caught.

Check and clean those areas about every three months under normal use. If you sew frequently, clean more often.

#### • Clean the Feed Dogs

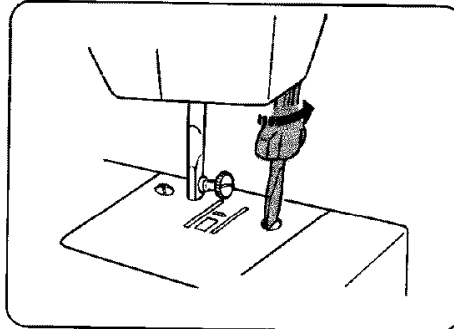

Follow these directions:

1. Unplug the machine. Remove presser foot and needle. Using a screw driver, remove needle plate.

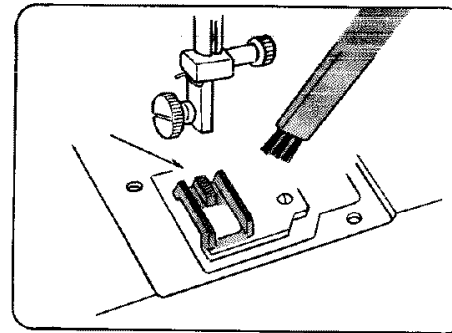

2. Use a lint brush and clean the feed dogs.

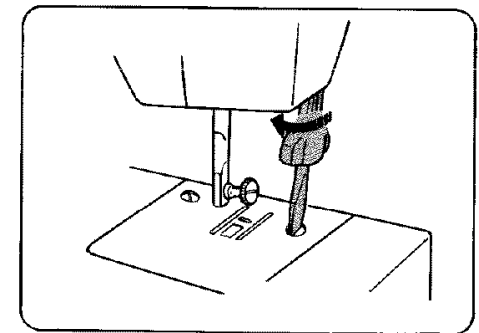

3. Replace needle plate into position.

• **Clean the Shuttle Race**

This area must be kept free of dust, lint and occasional tangled thread. Clean the shuttle race area about every three months.

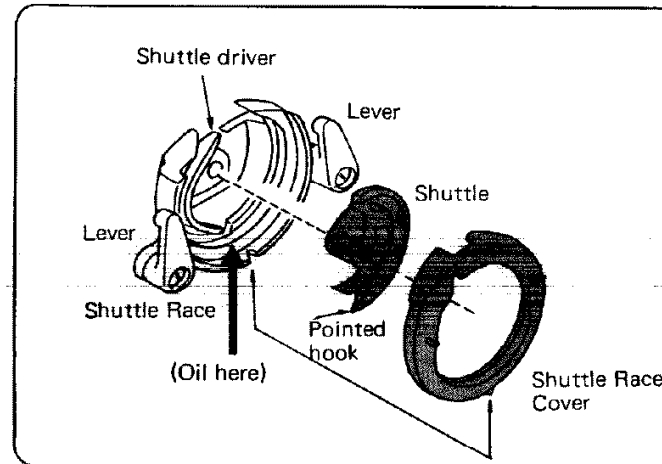
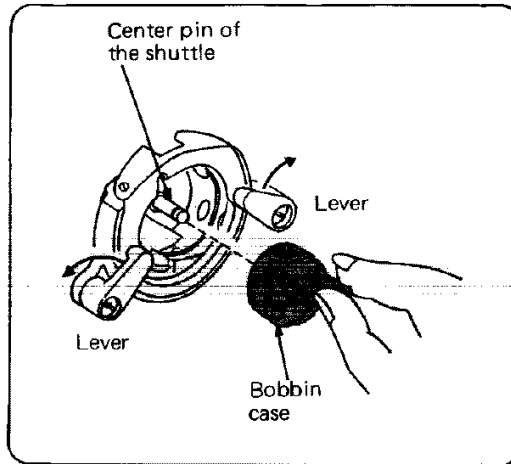

• **To Clean the Shuttle Area:**

1. Raise the needle bar to its highest point and remove the bobbin case.
2. ~~Push shuttle race levers aside. Lift shuttle race cover and take shuttle out.~~
3. Clean the shuttle race with a lint brush.
4. Put a drop of oil on the center pin of the shuttle and shuttle race. Do not over-oil.

**To Replace Shuttle Assembly:**

1. Position shuttle race as illustrated so that shuttle driver is forming half moon on the left side of the machine.
2. ~~Hold shuttle by center pin and position shuttle so as~~ to form a half moon on the right side. Pointed hook will be on the bottom.
3. Place shuttle race cover into place over shuttle assembly.
4. Snap the levers back into the original position.

## SECTION 5. CARE FOR YOUR MACHINE

### Oiling the Machine

Oil the machine in all areas shown on this page at least once a year; otherwise the machine can become sluggish or will knock loudly. If you use the machine frequently, oil the machine under the top cover about every three months. In case machine is not used for an extended time, oil it before sewing. Use good quality sewing machine oil. One or two drops of oil is sufficient. Remove excess oil, otherwise it may stain fabric.

Kenmore sewing machine oil is available at your nearest Sears retail store.

**NOTE:** Unplug the machine before oiling. Remove needle and put needle bar in full down position.

- Oil behind the Face Cover Plate and under the Arm Cover Plate

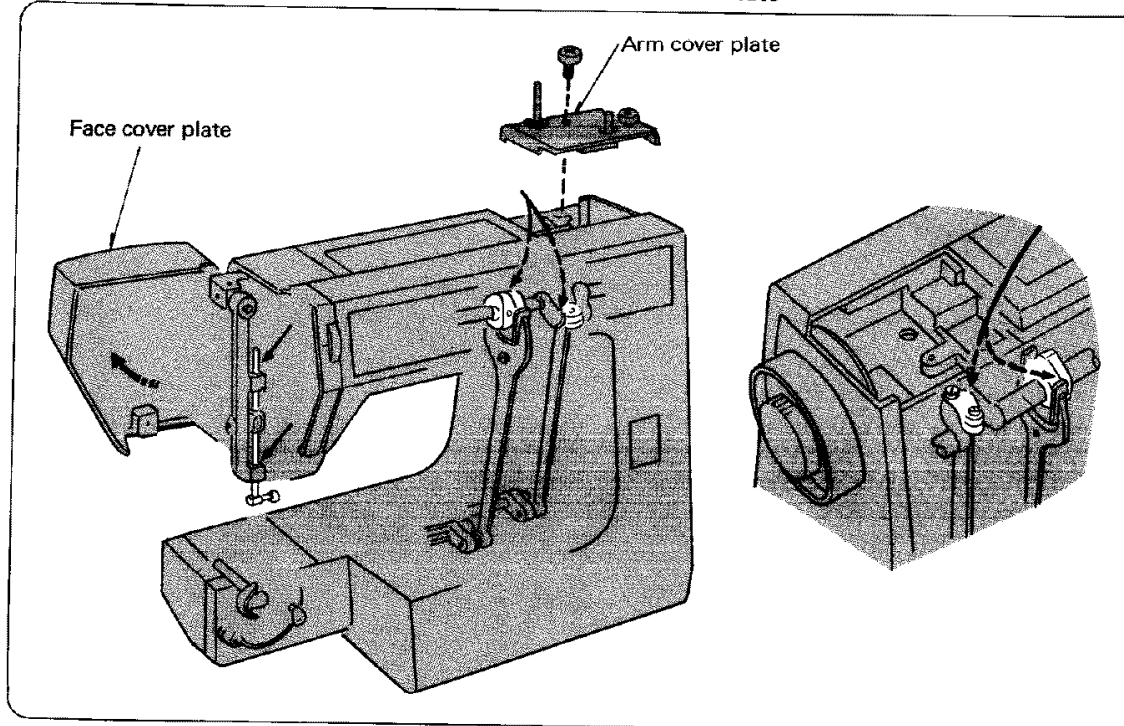

Open face cover plate and/or remove arm cover plate by loosening up top screw to oil points in illustration.

Use only a drop of oil; do not over-oil.

- Oil the Underside

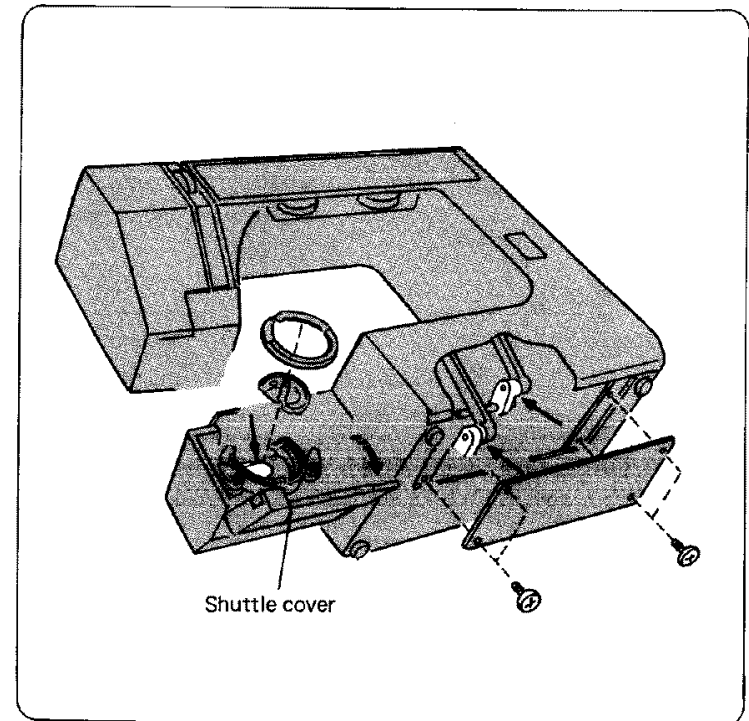

Open the shuttle cover by pulling down the embossed part on the left side of the cover. Tilt the machine head back and remove bottom cover. Oil points in illustration.

# PARTS LIST

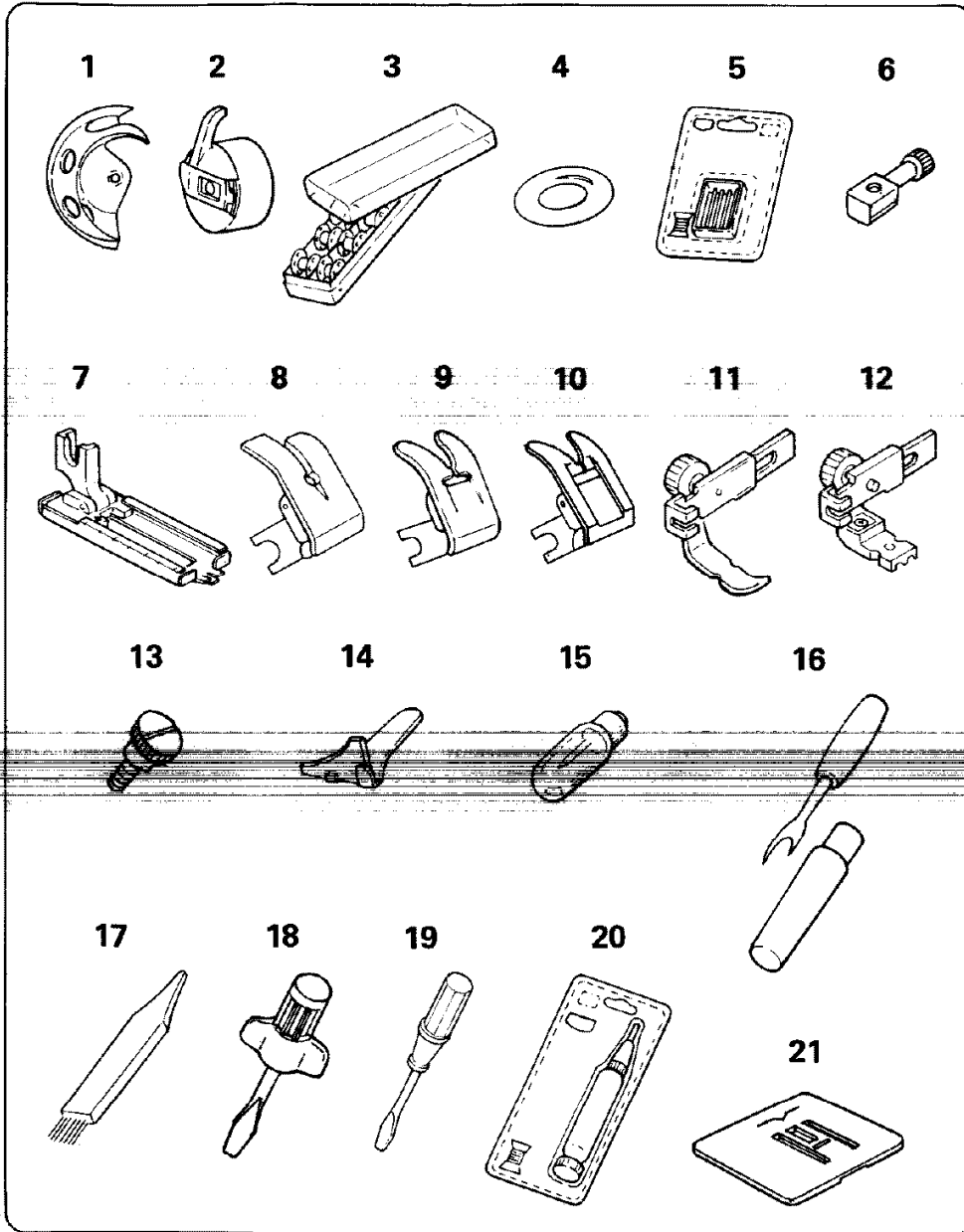

All parts listed herein may be ordered from any Sears store or service center.

WHEN ORDERING REPAIR PARTS, ALWAYS GIVE THE FOLLOWING INFORMATION:

1. PART NUMBER
2. PART DESCRIPTION
3. MODEL NUMBER
4. NAME OF ITEM

If the parts you need are not stocked locally, your order will be electronically transmitted to a Sears Repair Parts Distribution Center for expedited handling.

Ref. No.	Part No.	Description
1	47	Shuttle
2	6510	Bobbin case
3	*6862	Bobbin box with 10 bobbins
4	1939	Bobbin winder rubber ring
5	813404013	No. 11 Stretch fabric needles (BLU)
	6551	No. 11 Single needles (ORG)
	6552	No. 14 Single needles (RED)
	6553	No. 16 Single needles (PUR)
	6554	No. 18 Single needles (GRN)
6	652508002	Needle clamp with screw
7	648801108	Sliding buttonhole foot
8	650802003	Straight stitch foot
9	735503007	Standard zigzag foot
10	6870	Satin stitch foot
11	<del>593401666</del>	<del>Zipper foot</del>
12	*6757	Zipper foot
13	135	Thumb screw
14	*6864	Needle threader
15	6797	Light bulb
16	6830	Buttonhole opener
17	802424004	Lint brush
18	820832005	Large screw driver
19	41669	Small screw driver
20	*6889	Oil and lint brush
21	735801008	Darning plate

\* These items are not furnished with the machine, but may be ordered per instructions above.

## INDEX

- A**  
 Accessory storage box . . . . . 2, 6  
 Adjusting stretch stitch balance . . . . . 15  
 Applique . . . . . 22  
 Arm cover plate . . . . . 3, 38
- B**  
 Bar tacking . . . . . 22  
 Basic zigzag . . . . . 20  
 Blind hemming . . . . . 27  
 Bobbin . . . . . 3, 8 ~ 9, 39  
 Bobbin case . . . . . 8~9, 37, 39  
 Bobbin thread . . . . . 11~12  
 Bobbin winding . . . . . 8~9  
 Bobbin winding tension disc . . . . . 2, 9  
 Bobbin winding spindle . . . . . 2, 9  
 Box stitching . . . . . 33  
 Buttonhole . . . . . 28~29  
 Buttonhole opener . . . . . 3, 29, 39  
 Button sewing . . . . . 23
- C**  
 Cabinet . . . . . 2  
 Carrying handle . . . . . 3  
 Changing needle . . . . . 6  
 Changing presser foot . . . . . 6  
 Cleaning feed dogs and shuttle race . . . . . 36~37  
 Clutch knob . . . . . 3, 8, 9  
 Cording . . . . . 31  
 Cornering guide . . . . . 17
- D**  
 Darning . . . . . 19  
 Darning plate . . . . . 3, 18 ~ 19, 23, 39
- E**  
 Elastic stretch stitch . . . . . 33  
 Extension table . . . . . 2, 6
- F**  
 Fabric, needle, thread and stitch  
 length chart . . . . . 7  
 Face cover plate . . . . . 2, 38
- Feed dogs** . . . . . 36  
**Foot control** . . . . . 3~4  
**Free arm sewing** . . . . . 6
- H**  
 Hand wheel . . . . . 3, 16
- I**  
 Invisible zipper . . . . . 31
- L**  
 Lace work . . . . . 26  
 Large screw driver . . . . . 3, 39  
 Light and power switch . . . . . 3~4  
 Light bulb . . . . . 4, 36, 39  
 Lint brush . . . . . 3, 36, 39
- N**  
 Needle . . . . . 3, 6 ~ 7, 39  
 Needle clamp screw . . . . . 3, 6, 39  
 Needle plate . . . . . 2, 36  
 Needle, thread and fabric chart . . . . . 7
- O**  
 Oiling . . . . . 38  
 Overcasting stitch . . . . . 24  
 Overcast stretch stitching . . . . . 25
- P**  
 Parts list . . . . . 39  
 Performance problems chart . . . . . 34~35  
 Pine leaf stretch stitching . . . . . 25  
 Plug connector . . . . . 3~4  
 Portable case . . . . . 2  
 Power switch . . . . . 4  
 Presser foot . . . . . 3  
 Presser foot lever . . . . . 3, 5
- R**  
 Replacing bobbin case . . . . . 8~9  
 Reverse stitch control . . . . . 2, 15  
 Rick rack stretch . . . . . 24
- S**  
 Satin stitch foot . . . . . 3, 21 ~ 22, 39  
 Satin stitch . . . . . 21  
 Seam guides . . . . . 17  
 Serging . . . . . 25  
 Sewing light . . . . . 4  
 Shell stitching . . . . . 32  
 Shuttle . . . . . 37, 39  
 Shuttle cover . . . . . 2, 8  
 Shuttle race . . . . . 37  
 Sliding buttonhole foot . . . . . 3, 28 ~ 29, 39  
 Small screw driver . . . . . 3, 39  
 Smocking . . . . . 32  
 Spool pin . . . . . 2, 5  
 Stitch length control . . . . . 2, 14  
 Stitch selector . . . . . 2, 14  
 Straight stitch . . . . . 17~18  
 Straight stitch foot . . . . . 3, 17~19, 39  
 Straight stretch . . . . . 19
- T**  
 Thread cutter . . . . . 2, 5  
 Thread guide . . . . . 2  
 Thread take-up lever . . . . . 2, 10  
 Thread tensions . . . . . 12~13  
 Three-step zigzag . . . . . 26  
 Topstitching . . . . . 18  
 Top thread . . . . . 10~13  
 Top thread tension . . . . . 12~13  
 Top thread tension control . . . . . 2  
 Turn a square corner . . . . . 17
- Z**  
 Zigzag foot . . . . . 17~20, 22~27, 32~33, 39  
 Zigzag stitches . . . . . 20~26  
 Zipper application . . . . . 30~31  
 Zipper foot . . . . . 3, 30~31, 39

# MEMO

# MEMO

## WARRANTY

### FULL 25-YEAR WARRANTY ON SEWING MACHINE HEAD

For 25 years from the date of purchase, Sears will, free of charge, repair defects in material or workmanship which appear in the mechanical components of the sewing machine head.

### FULL TWO YEAR WARRANTY ON ELECTRICAL EQUIPMENT OF SEWING MACHINE

For two years from the date of purchase, Sears will, free of charge, repair defects in material or workmanship which appear in the electrical equipment of the sewing machine, including electronic components, motor, wiring, switch and speed control.

### FULL 90-DAY WARRANTY ON ALL PARTS AND MECHANICAL ADJUSTMENTS

For 90 days from the date of purchase, Sears will, free of charge, replace any parts and provide mechanical service necessary for proper operation of the sewing machine, except for normal maintenance.

---

**WARRANTY SERVICE IS AVAILABLE BY RETURNING THE SEWING MACHINE TO THE NEAREST SEARS SERVICE CENTER/DEPARTMENT IN THE UNITED STATES.**

This warranty gives you specific legal rights, and you may also have other rights which vary from state to state.

**SEARS, ROEBUCK AND CO., D/817 WA, Hoffman Estates, IL 60179**