

COOKER HOOD

INSTRUCTION MANUAL AND INSTALLATION GUIDE

Please read this guide before installing and using the hood

MODEL	DESCRIPTION
CK90TBTF	90cm T shape canopy
CK120TBTF	120cm T shape canopy



Emilia Glem Appliances

48 Percy Street Auburn NSW 2144

PO BOX 63 Blaxcell PO South Granville NSW 2142

Tel 02 9721 2755 Fax 02 9721 2766 www.glemgas.com.au

Product Specification & Technical Parameters

Model	CK90TBTF/CK120TBTF
Rated Voltage	230V
Rated Power Frequency	50Hz
Light Power	1x4W MAX
Motor Power	230W
Total Power	234W
Motor	Single
Diameter of Outlet Adapter	150mm
Dimension (mm)	W900/1200 X D500 X H570min/1050max

RECOMMENDATIONS AND SUGGESTIONS

INSTALLATION

* The manufacturer will not be held liable for any damages resulting from incorrect or improper installation.

* Please read this instruction manual before installing and using this range hood. Please keep this instruction manual in a safe place for future reference.

* Only a qualified and trained service technician can undertake the work of installation and servicing.

* Check that the main voltage corresponds to the one indicated on the rating plate fixed inside the hood.

* If the hood is used in conjunction with non-electrical appliances (e. g. gas burning appliances), a sufficient degree of ventilation must be guaranteed in the room in order to prevent the backflow of exhaust gas. The kitchen must have an opening directly with the open air in order to guarantee the entry of clean air.

* The minimum distance is 750mm from the range hood to a gas hob, and is 650mm to an electric hob. If the installation instructions for gas hobs specify a greater distance, this must be taken into account.

NOTICE: Two or more people are required to install or move this appliance. Failure to do so can cause physical injuries.

USE

- * The range hood has been designed only for domestic use to eliminate kitchen fumes.
- * Never use the hood for purposes other than what it has not been designed for.
- * Never leave high naked flames under the hood when it is in operation.
- * Adjust the flame intensity to direct it onto the bottom of the pan only; making sure that it does not engulf the pan sides.
- * Deep fat fryer must be continuously monitored during use: overheated oil can burst into flame.
- * The hood should not be used by children or persons not instructed in its correct use.

MAINTENANCE

- * Proper maintenance of the range hood will assure proper performance of the unit.
- * Disconnect the hood from the main supply before carrying out any maintenance work.
- * Clean and/or replace aluminum grease filters and activated charcoal filters after specified period of time.
- * Clean the hood using a damp cloth and a neutral liquid detergent.
- * DISPOSAL: Do not dispose this product as unsorted municipal waste. Collection of such waste separately for special treatment is necessary.

WARNING!!

In certain circumstances electrical appliances may be a danger hazard.

- * Do not check the status of the filters while the cooker hood is operating
- * Do not touch the light bulbs after appliance use
- * Do not disconnect the appliance with wet hands.
- * To reduce the risk of fire or electric shock, do not use this fan with any solid-state.
- * Avoid free flame, as it would do damage to the filters from a fire hazard
- * Constantly check food frying to avoid that the overheated oil may become a fire hazard
- * Disconnect the electrical plug prior to any maintenance or servicing.
- * Children don't recognize the risks of electrical appliances. Therefore use or keep the appliance only under supervision of adults and out of the reach from children.

* TO REDUCE THE RISK OF FIRE, ELECTRIC SHOCK, OR INJURY TO PERSONS, OBSERVE THE FOLLOWING:

- a) Installation work and electrical wiring must be done by qualified person(s) in accordance with all applicable codes and standards, including fire-rated construction.
- b) Sufficient air is needed for proper combustion and exhausting of gases through the flue (chimney) of fuel burning equipment to prevent back drafting.
- c) When cutting or drilling into wall or ceiling, do not damage electrical wiring and other hidden utilities.
- d) Ducted fans must always be vented to the outdoors.

* Don't use this product outdoors.

* This appliance is not intended for use by persons (including children) with reduced physical, sensory or mental capabilities, or lack of experience and knowledge, unless they have been given supervision or instruction, concerning use of the appliance by a person responsible for their safety. Children should be supervised to ensure that they do not play with the appliance.

* There shall be adequate ventilation of the room when the range hood is used at the same time as appliances burning gas or other fuels.

* There is a fire risk if cleaning is not carried out in accordance with instructions.

* The exhaust air must not be discharged into a flue which is used for exhausting fumes from appliances burning gas or other fuels.

DIMENSIONS

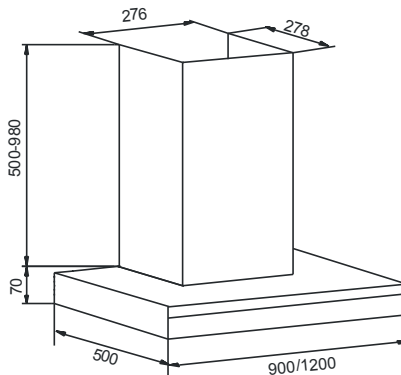

INSTALLATION & USE

OPERATION OF CONTROLS

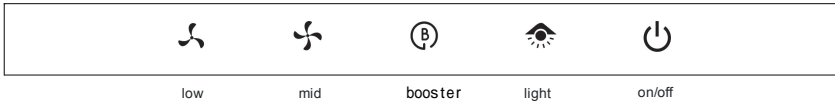

The hood is operated using the touch control.

The on/off switch turns the hood on and off.

The light switch turns the lamps on and off.

The blower switch turns the blower on to three speed settings:

1 - LOW SPEED

2 - MEDIUM SPEED

3 - BOOSTER

Grease Filters

The grease filters should be cleaned frequently. Use a warm detergent solution. Grease filters are washable.

See "INSTALL FILTERS" section for removal and installation instructions.

INSTALL THE DUCTWORK

(DUCTED HOODS ONLY)

Caution: To reduce the risk of fire, use metal ductwork is preferred.

1. Decide where the ductwork will run between the hood and the outside.
2. A straight, short duct run will allow the hood to perform most efficiently.
3. Long duct runs, elbows, and transitions will reduce the performance of the hood. Use as few of them as possible. Larger ducting may be required for best performance with longer duct runs.
4. The air must not be discharge into a flue that is used for exhausting fumes from appliances burning gas or other fuels" "Regulations concerning the discharge of air have to be fulfilled.
5. Install wall cap. Connect round metal ductwork to cap and work back towards hood location. Use duct tape to seal the joints between

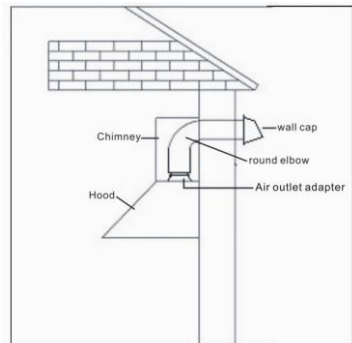

ductwork sections.

INSTALL ELECTRICAL

Electrical wiring must be done by a qualified person(s) in accordance with all applicable codes and standards. This range hood must be properly grounded. Turn off electrical power at service entrance before wiring.

If the supply cord is damaged, it must be replaced by the manufacturer, its service agent or similarly qualified persons in order to avoid a hazard.

INSTALL THE HOOD

Note 1 : On stainless steel hoods, carefully remove the plastic protective film from all exterior surfaces of the hood and chimney prior to final installation.

Note 2: At least two people will be required to mount the hood.

INSTALL THE HOOD

Minimum hood distance above the cooker must not be less than 650mm.

A maximum of 750mm above the cooker is highly recommended for best capture of cooking impurities.

Distance over 750mm above the cooker are at the installer's and user's discretion - providing that ceiling height and flue length permit.

1. Secure the hood mounting bracket to the wall using (3) **ST 5 x 45mm** mounting screws and dry wall anchors. Align the hood body with the hood mounting bracket. Gently lower the hood until it securely engages the bracket.
2. Fix the discharge collar into the air outlet adapter.
3. Attach an adequate length of 150mm round duct to the air outlet adapter **(if have)**.
4. Carefully slide the decorative chimney top down inside the decorative



chimney bottom. Carefully place the decorative chimney bottom into the recessed area of the hood body top.

5. Secure the chimney mounting bracket to the wall using (2) **ST 2.9 x 14**mm mounting screws and dry wall anchors.
6. Raise the decorative chimney top until its holes align with holes in the chimney mounting bracket (located on the wall).
7. Level the hood and secure the chimney with 2 chimney bracket screws.
8. Fix the Decorative Chimney Bottom with 3 decorative Chimney Bottom screws from inside of body.

1、

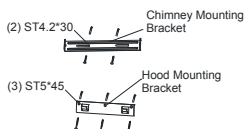

2、

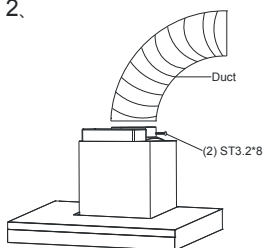

3、

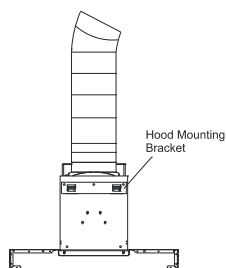

4、

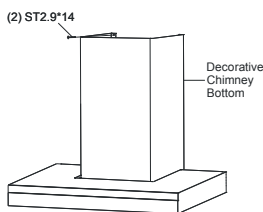

5、

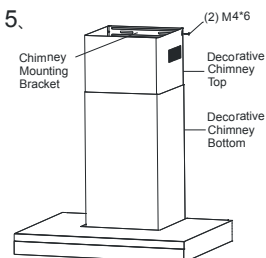

6、

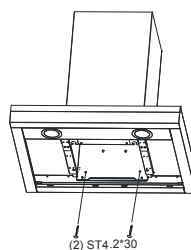

INSTALL FILTERS

1. To remove the grease filter, push in on the metal latch tab. This will disengage the filter from the hood. Tilt the filter downward and remove.
2. To install the grease filter, align rear filter tabs with slots in the hood. Push in the metal latch tab, push filter into position and release. Make sure the filter is securely engaged after assembly.

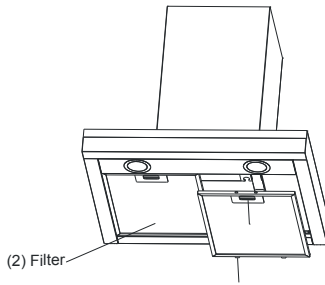

3. To install the charcoal filter (optional), and lock it until the stop click is heard.

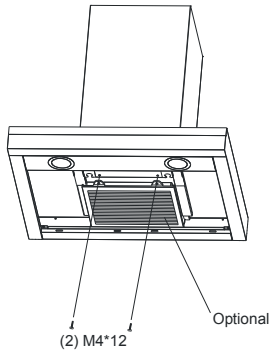

4. Install grease filter after charcoal filter is installed.





GLEM GAS AUSTRALASIA PTY. LTD. PRODUCT WARRANTY

Thank you for choosing an Emilia Glem Appliance, the purchase of this appliance is an important investment in your home and so to protect your investment we urge you to complete the registration card attached, please return it immediately.

IT IS A WARRANTY REQUIREMENT THAT PROOF OF PURCHASE BE PROVIDED PRIOR TO REQUESTING A SERVICE CALL. THIS WARRANTY SHALL NOT APPLY IF THE APPLIANCE WAS NOT INSTALLED BY A LICENSED TECHNICIAN AND PROOF IS NOT SUPPLIED.

The benefits conferred by this warranty are in addition to all other conditions and warranties in respect of this product which the consumer may have under the Trade Practices Act 1874 of the Commonwealth of Australia and/or similar State or Territory Laws.

Our goods come with guarantees that cannot be excluded under the Australian Consumer Law. You are entitled to a replacement or refund for a major failure and for compensation for any other reasonably foreseeable loss or damage. You are also entitled to have the goods repaired or replaced if the goods fail to be of acceptable quality and the failure does not amount to a major failure.

Glem Gas Australasia Pty Ltd warrants, this appliance to be free from defects in workmanship and materials for a period of:
a) Where the appliance is intended to be used and is used for DOMESTIC USE – 24 MONTHS FROM DATE OF DELIVERY TO THE ORIGINAL PURCHASER.

b) Where the appliance is intended to be used and is used for COMMERCIAL USE – 90 DAYS FROM DATE OF DELIVERY TO THE ORIGINAL PURCHASER.

Glem Gas Australasia Pty Ltd, during the period of warranty, will at its option, and subject to the terms and conditions stated below, repair or replace free of charge this appliance or any component part, which upon examination by Glem Appliances P/L. is found to be defective.

THIS WARRANTY SHALL NOT APPLY:

- a) If the rating plate has been removed or the serial number or other details on it have been removed or rendered illegible.
- b) If the appliance is connected to any voltage other than shown on rating plate.
- c) If the appliance has been subjected to misuse, abuse accident or want of care.
- d) If the appliance has been installed, operated or maintained contrary to the instructions supplied by Glem Gas Australasia P/L.
- e) If any defect or failure is due to connection to an inadequate or faulty power supply.
- f) If damage is caused by foreign objects in or on the appliance or by reason of its use for purposes other than that for which it was delivered.
- g) If a repair has been made or attempted by the purchaser.
- h) Where the appliance is installed outside an 80km radius from the GPO of any Australian Capital City to freight and travel costs beyond that radius.

This warranty does not cover any glass damage or replacement of light bulbs.

Parts covered under warranty that need replacing i.e.: seals, knobs or filters. These can be posted to customer to put on at their discretion.

This Warranty is given by Glem Gas Australasia Pty Ltd and no other person or organisation is authorised to vary its provisions and conditions.

Complete this section and keep it for your own record.

Appliance type	<input type="text"/>	Model No.	<input type="text"/>	Serial no.	<input type="text"/>
Purchased from	<input type="text"/>	Date of purchase	<input type="text"/>		<input type="text"/>

Please complete the section below and return to:

Glem Gas Australasia Pty. Ltd, PO Box 63 Blaxcell PO South Granville or fax to 02 9721 2766

WARRANTY FORM

Appliance type	<input type="text"/>	Model No.	<input type="text"/>	Serial no.	<input type="text"/>
Purchased from	<input type="text"/>	Date of purchase	<input type="text"/>		

Customer Name	<input type="text"/>	Address	<input type="text"/>
---------------	----------------------	---------	----------------------

Installers Name	<input type="text"/>	Installers licence no.	<input type="text"/>
-----------------	----------------------	------------------------	----------------------

Installers Signature	<input type="text"/>
Installers Compliance Number	<input type="text"/>