

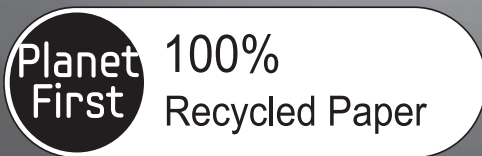

WA10H7200G*
WA90H7000G*

Washing Machine

user manual



This manual is made with 100% recycled paper.

Imagine the possibilities

Thank you for purchasing this Samsung product.



contents

INSTALLING YOUR WASHER	10	10	Unpacking your washer
		10	Overview of your washer
		11	Basic location requirements
		11	Electrical
		11	Grounding
		11	Water
		12	Drain facility
		12	Flooring
		12	Location considerations
		12	Alcove or closet installation
		13	Required dimensions for Installation
		13	Important note to installer
		17	Loading your washer
		17	Getting started
OPERATING INSTRUCTIONS	17		
WASHING A LOAD OF LAUNDRY	18	18	Overview of the control panel
		20	Child Lock [🔒]
		21	Sound 🔊
		21	Garment+ [👕]
		21	Delay End
		21	Wash
		21	Spin
		21	Power Wash
		22	Mist Shower
		22	Smart Check
		23	Washing clothes using the cycle selector
		24	Detergent use
		24	Features
		26	Cleaning the exterior
		26	Cleaning the interior
		26	Storing your washer
		26	Preserving the top cover and the front frame
		27	Cleaning the filter
		28	Cleaning the dispensers
		29	Tub Clean
MAINTAINING YOUR WASHER	26	30	Check these solutions if your washer...
		32	Information codes
TROUBLESHOOTING	30		
APPENDIX	34	34	Fabric care chart
		35	Cycle chart
		36	Helping the environment
		36	Declaration of conformity
		36	Specification

safety information











Congratulations on your new Samsung Washer. This manual contains important information on the installation, use, and care of your appliance. Please take time to read this manual to take full advantage of your washer's many benefits and features.

WHAT YOU NEED TO KNOW ABOUT SAFETY INSTRUCTIONS

Warnings and Important Safety Instructions in this manual do not cover all possible conditions and situations that may occur. It is your responsibility to use common sense, caution, and care when installing, maintaining, and operating your washer.

IMPORTANT SAFETY SYMBOLS AND PRECAUTIONS

What the icons and signs in this user manual mean:

 WARNING	Hazards or unsafe practices that may result in severe personal injury or death . To reduce the risk of fire, explosion, electric shock, or personal injury when using your washer, follow these basic safety precautions:
 CAUTION	Hazards or unsafe practices that may result in minor personal injury or property damage .
	Do NOT attempt.
	Do NOT disassemble.
	Do NOT touch.
	Follow directions explicitly.
	Unplug the power plug from the wall socket.
	Make sure the machine is grounded to prevent electric shock.
	Call the service center for help.
	Note

These warning icons are here to prevent injury to you and others.

Please heed them explicitly.

After reading this section, keep it in a safe place for future reference.

 Read all instructions before using the appliance.

safety information



WARNING: To reduce the risk of fire, electric shock, or injury to persons when using your appliance, follow basic precautions, including the following:

Do not let children (or pets) play in or on your washing machine. The washing machine door does not open easily from the inside and children may be seriously injured if trapped inside.

This appliance is not to be used by persons (including children) with reduced physical, sensory or mental capabilities, or lack of experience and knowledge, unless they have been given supervision or instruction concerning use of the appliance by a person responsible for their safety. Children should be supervised to ensure that they do not play with the appliance.

For use in Europe: This appliance can be used by children aged from 8 years and above and persons with reduced physical, sensory or mental capabilities or lack of experience and knowledge if they have been given supervision or instruction concerning use of the appliance in a safe way and understand the hazards involved.

Children shall not play with the appliance. Cleaning and user maintenance shall not be made by children without supervision.

If the supply cord is damaged, it must be replaced by the manufacturer, its service agent or similarly qualified persons in order to avoid a hazard.

This appliance should be positioned so that the power plug, the water supply taps, and the drain pipes are accessible.

For appliances with ventilation openings in the base, that a carpet must not obstruct the openings.

The new hose-sets supplied with the appliance are to be used and that old hose-sets should not be reused.

CAUTION: In order to avoid a hazard due to inadvertent resetting of the thermal cut-out, this appliance must not be supplied through an external switching device, such as a timer, or connected to a circuit that is regularly switched on and off by the utility.



CRITICAL INSTALLATION WARNINGS



Plug the power cord into an AC 220-240 V / 50 Hz/wall socket rated at 15 amps or higher. Use the socket for this appliance only. In addition, do not use an extension cord.

- Sharing a wall socket with other appliances, using a power strip, or extending the power cord may result in electric shock or fire.
- Do not use an electric transformer. It may result in electric shock or fire.
- Ensure that the power voltage, frequency, and current match the product's specifications. Failing to do so may result in electric shock or fire.

Have this appliance installed by a qualified technician or service company.

- Failing to do so may result in electric shock, fire, an explosion, problems with the product, or injury.

Remove all foreign substances such as dust or water from the power plug terminals and contact points using a dry cloth on a regular basis.

- Unplug the power plug and clean it with a dry cloth.
- Failing to do so may result in electric shock or fire.

Plug the power plug into the wall socket in the right direction so that the cord runs towards the floor.

- If you plug the power plug into the socket in the opposite direction, the electric wires within the cable may be damaged and this may result in electric shock or fire.
-



This appliance must be properly grounded.

Do not ground the appliance to a gas pipe, plastic water pipe, or telephone line.

- Improper grounding may result in electric shock, fire, an explosion, or problems with the product
 - Never plug the power cord into a socket that is not grounded correctly. Make sure the socket you use is grounded in accordance with local and national codes.
-



Do not install this appliance near a heater or inflammable material.

Do not install this appliance in a humid, oily, or dusty location, or in a location exposed to direct sunlight or water (rain drops).

Do not install this appliance in a location where gas may leak.

- This may result in electric shock or fire.

Plug the power plug into the wall socket firmly. Do not use a damaged power plug, damaged power cord, or loose wall socket.

- This may result in electric shock or fire.

Do not pull or excessively bend the power cord.

Do not twist or tie the power cord.

Do not hook the power cord over a metal object, place a heavy object on the power cord, insert the power cord between objects, or push the power cord into the space behind the appliance.

- This may result in electric shock or fire.

Do not pull the power cord when unplugging the power plug.

- Unplug the power plug by holding the plug.
 - Failing to do so may result in electric shock or fire.
-



If the power plug or power cord are damaged, contact your nearest service center.

safety information



INSTALLATION CAUTIONS

- ★ Position the appliance so that the power plug is easily accessible.
 - Failing to do so may result in electric shock or fire due to electric leakage.
- Install your appliance on a level and hard floor that can support its weight.
- Failing to do so may result in abnormal vibrations, noise, or problems with the product.

- 🔌 Unplug the power plug when the appliance is not being used for long periods of time or during a thunder/lightning storm.
 - Failing to do so may result in electric shock or fire.



CRITICAL USAGE WARNINGS

- ★ If the appliance is flooded, cut the power immediately and contact your nearest service center.

If the appliance emits a strange noise, a burning smell, or smoke, unplug the power plug immediately and contact your nearest service center.

- Failing to do so may result in electric shock or fire.

In the event of a gas leak (such as propane gas, LP gas, etc.), ventilate the area immediately. Do not turn any appliance or light on or off.

- Do not use a ventilating fan.
- A spark may result in an explosion or fire.

Do not wash items contaminated with gasoline, kerosene, benzene, paint thinner, alcohol or other flammable or explosive substances.

- This may result in electric shock, fire, or an explosion.

Do not force the washer lid open while the washer is operating (high-temperature washing/drying/spinning).

- Water flowing out of the washer may cause burns or cause the floor to be slippery.
 - This may result in injury.
- Forcing the lid open can damage the product or cause injury.

Make sure to remove the packaging (sponge, styrofoam) attached to the bottom of the washer before using it.

Do not insert your hand under the washer.

- This may result in injury.

-  Do not touch the power plug with wet hands.
- This may result in electric shock.

Do not turn the appliance off by unplugging the power plug while the washer is in operation.

- Plugging the power plug into the wall socket again may cause a spark and result in electric shock or fire.

Keep all packaging materials well out of the reach of children, as packaging materials can be dangerous to children.

- If a child places a bag over its head, it may suffocate.

Do not let children or infirm persons use this washer unsupervised.

- Failing to do so may result in electric shock, burns or injury.

Do not insert your hand or a metal object under the washer while it is operating.

- This may result in injury.

-
-  Do not attempt to repair, disassemble, or modify the appliance yourself.
- Do not use any fuse (such as cooper, steel wire, etc.) other than the standard fuse.
 - If you need to repair or reinstall the appliance, contact your nearest service center.
 - Failing to do so may result in electric shock, fire, problems with the product, or injury.

-
-  If any foreign substance such as water enters the appliance in any area other than the tub, unplug the power plug and contact your nearest service center.
- Failing to do so may result in electric shock or fire.

If the water supply hose comes loose from the faucet and floods the appliance, unplug the power plug.

- Failing to do so may result in electric shock or fire.



USAGE CAUTIONS

-  If the washer is contaminated by a foreign substance such as detergent, dirt, food waste, etc., unplug the power plug and clean the washer using a damp, soft cloth.

- Failing to do so may result in discoloration, deformation, damage or rust.

The clear portion of the lid can be broken by a strong impact. Take care when using the washer.

- If the clear portion is cracked or broken, it may result in injury.

After a water supply failure or when reconnecting the water supply hose, open the faucet slowly.

Open the faucet slowly after a long period of non-use.

- The air pressure in the water supply hose or the water pipe may result in damage to a part or in water leakage.

If a drain error occurs during an operation, check if there is a draining problem.

- If the washer is used when it is flooded because of a draining problem, it may result in electric shock or fire due to electric leakage.

Do not insert your hand under the washer.

- This may result in injury.

safety information

Insert the laundry into the washer completely so that laundry does not get caught in the lid.

- If laundry gets caught in the lid, it may result in damage to the laundry or the washer, or result in water leakage.

Ensure that the faucet is turned off when the washer is not being used.

- Ensure that the water supply hose connectors are properly tightened.
- Failing to do so may result in property damage or injury.

Open the faucet and check if the water supply hose connector is firmly tightened and that there is no water leaking before using the product.

- If the water supply hose connectors are loose, it may result in water leakage.

Do not stand on top of the appliance or place objects (such as laundry, lighted candles, lighted cigarettes, dishes, chemicals, metal objects, etc.) on the appliance.

- This may result in electric shock, fire, problems with the product, or injury.

Do not operate the appliance with wet hands.

- This may result in electric shock.

Do not spray volatile material such as insecticide onto the surface of the appliance.

- As well as being harmful to humans, it may also result in electric shock, fire, or problems with the product.

Do not place an object that generates an electromagnetic field near the washer.

- This may result in injury due to a malfunction.

Since the water drained during a high-temperature wash or drying cycle is hot, do not touch the water.

- This may result in burns or injury.

Do not wash, spin, or dry water-proof seats, mats, or clothing*.

- Do not wash thick, hard mats even if the washer mark is on the care label. This may result in injury or damage to the washer, walls, floor, or clothing due to abnormal vibrations.

* Items not to wash: Woolen bedding, rain covers, fishing vests, ski pants, sleeping bags, diaper covers, sweat suits, and bicycle, motor cycle, car covers, etc.

Do not operate the washer when detergent dispenser is removed.

- This may result in electric shock or injury due to water leakage.

Do not insert your hand into the detergent dispenser after opening it.

- This may result in injury as your hand may be caught.

Do not place any non-laundry objects, such as shoes, food waste, or animals into the washer.

- This can cause abnormal vibrations that can damage the washer, and, in the case of pets, cause severe injury or death.

Do not press the buttons using sharp objects such as pins, knives, fingernails, etc.

- This may result in electric shock or injury.

Do not wash laundry contaminated by oils, creams, or lotions usually found in skincare shops or massage clinics.

- This may result in the rubber seal becoming deformed and water leakage.

Do not leave metal objects (safety pins, hair pins, etc.) or bleach in the tub for long periods of time.

- This may cause the tub to rust.
- If rust appears on the surface of the tub, apply a neutral cleansing agent to the surface and use a sponge to clean it. Never use a metal brush.

Do not use dry cleaning detergent directly and do not wash, rinse, or spin laundry contaminated by dry cleaning detergent.

- This may result in spontaneous combustion or ignition due to heat from the oxidation of the oil.

Do not use hot water from water cooling/heating devices.

- This may result in problems with the washer.

Do not use natural hand-washing soap in the washer.

- If it hardens and accumulates inside the washer, it may cause problems with the product, discoloration, rust, or bad odors.

Do not wash large laundry items such as bedding in the washing net.

- Failing to do so may result in injury due to abnormal vibrations.
- Place smaller items, such as lace socks and lingerie in the washing net.

Do not use hardened detergent.

- If it accumulates inside the washer, it may result in water leakage.

Do not wash throw rugs or doormats.

- If you wash throw rugs or doormats, the sand will accumulate inside the washer. It may result in error such as no draining.



WARNING

CRITICAL CLEANING INSTRUCTIONS



Do not clean the appliance by spraying water directly onto it.

Do not use the strong acid cleaning agent.

Do not use benzene, thinner, or alcohol to clean the appliance.

- This may result in discoloration, deformation, damage, electric shock, or fire.

Before cleaning or performing maintenance, unplug the appliance from the wall socket.

- Failing to do so may result in electric shock or fire.

installing your washer

UNPACKING YOUR WASHER

Unpack your washer and inspect it for shipping damage. Make sure you have received all the items shown below. If your washer was damaged during shipping, or you do not have all of the items, contact 1300-362-603.

To prevent personal injury or strain, wear protective gloves whenever lifting or carrying the unit.

WARNING  Packing materials can be dangerous to children; Keep all packing material (plastic bags, polystyrene, etc.) well out of children's reach.

CAUTION  When unpacking the washing machine, 2 person collaboration is needed. To remove the cushion bottom of the packing materials, forward dumping is strictly prohibited.

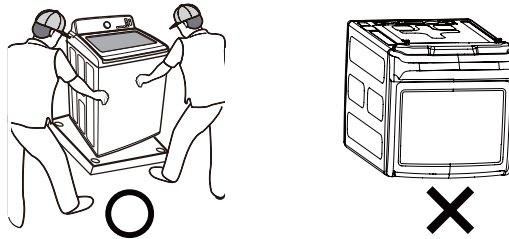

OVERVIEW OF YOUR WASHER

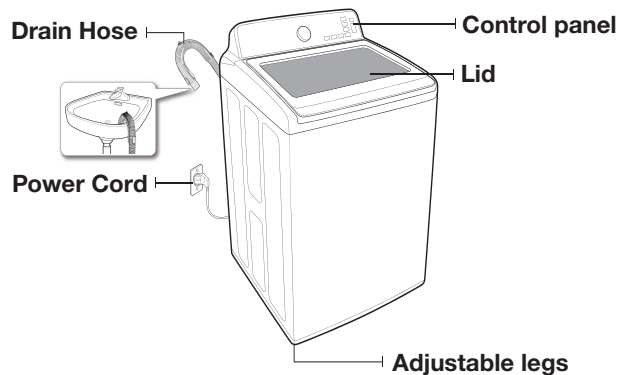

Parts supplied



Hose guide



User manual book

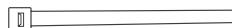

Plastic zip hose tie

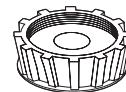

Water intake cap

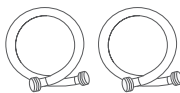

Water supply hoses

Tools needed



Wrench



Flat screwdriver



Level

BASIC LOCATION REQUIREMENTS

Electrical

- 220-240 Volt 50 Hz 15 AMP fuse or circuit breaker
- Individual branch circuit serving only your Washer is recommended.
- Your Washer is equipped with a power cord.

 **CAUTION** NEVER USE AN EXTENSION CORD.

Grounding

ELECTRICAL GROUNDING IS REQUIRED FOR THIS APPLIANCE.

This appliance must be grounded. In the event of malfunction or breakdown, grounding will reduce the risk of electric shock by providing a path of least resistance for electric current.

This appliance is equipped with a power cord having a three-prong grounding plug for use in a properly installed and grounded outlet.

The plug must be plugged into an appropriate outlet that is properly installed and grounded in accordance with all local codes and ordinances.

 **WARNING** An improperly connected equipment-grounding conductor can increase the risk of electrical shock. Check with a qualified electrician or serviceman if you are not sure whether the appliance is properly grounded. Do not modify the plug provided with the appliance – if it does not fit the outlet, have a proper outlet installed by a qualified electrician.

IMPORTANT SAFETY PRECAUTIONS

- To prevent unnecessary risk of fire, electrical shock or personal injury, all wiring and grounding must be done in accordance with the National Electrical Code ANSI/FNPA, No. 70 Latest Revision and local codes and ordinances. It is the personal responsibility of the appliance owner to provide adequate electrical service for this appliance.

 **CAUTION** NEVER CONNECT THE GROUND WIRE TO PLASTIC PLUMBING LINES, GAS LINES, OR HOT WATER PIPES.

Water

To correctly fill your Washer in the proper amount of time, water pressure of 20 to 116psi (137 to 800kPa) is required.

Water pressure less than 20 psi may cause water valve failure, or may not allow the water valve to shut off completely, or may extend the fill time beyond what your Washer controls allow, causing your Washer to turn off. A time limit is built into the controls to prevent flooding in your home if a hose becomes loose.

The water faucets must be within 4 feet / 122 cm of the back of your Washer to match the inlet hoses provided with your Washer.

 Accessory inlet hoses are available in various lengths up to 10 feet / 275 cm for faucets that are further away from the back of your Washer.

To avoid the possibility of water damage:

- Have water faucets easily accessible
- Turn off faucets when the washer is not in use.
- Periodically check that there is no leakage from the water inlet hose fittings.

 **WARNING** CHECK ALL CONNECTIONS AT THE WATER VALVE AND FAUCET FOR LEAKS.

installing your washer

Drain facility

The recommended height of the standpipe is 39 in / 99 cm. The drain hose must be routed through the drain hose clip to the standpipe. The standpipe must be large enough to accept the outside diameter of the drain hose. The drain hose is attached to the washer at the factory.

Flooring

For best performance, you must install your washer on a solidly constructed floor. Wood floors may need to be reinforced to minimize vibration and/or unbalanced load situations. Carpeting and soft tile surfaces are contributing factors to vibration which can cause your washer to move slightly during the spin cycle.

Never install your washer on a platform or weakly supported structure.

Location considerations

Do not install your washer in areas where water may freeze, since your washer will always retain some water in its water valve, pump, and hose areas. Frozen water can damage the belts, the pump, hoses, and other components.

Alcove or closet installation

MINIMUM CLEARANCES FOR CLOSET AND ALCOVE INSTALLATIONS:

Sides – 1 in / 25 mm

Closet Front – 2 in / 51 mm

Rear – 6 in / 152 mm

TOP - 21 in / 533 mm

Gap between end of water valve and the wall

- Case 1. Assemble supply hose after installing : Over 3.9 in (10 cm).
- Case 2. Assemble supply hose before installing : Over 2.8 in (7cm).

If the washer and dryer are installed together, the closet front must have at least a 72 in² (465 cm²) unobstructed air opening. Your washer alone does not require a specific air opening.

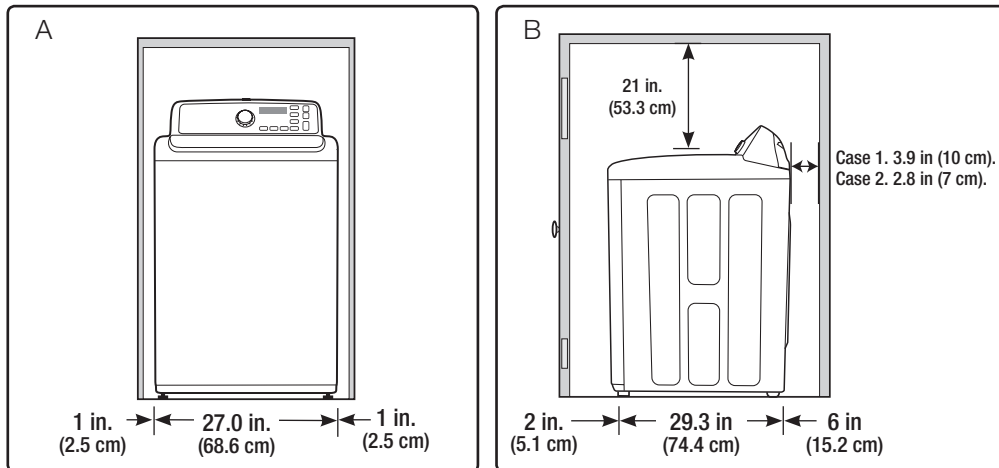

A. Recessed area

B. Side view - closet or confined area

Required dimensions for Installation

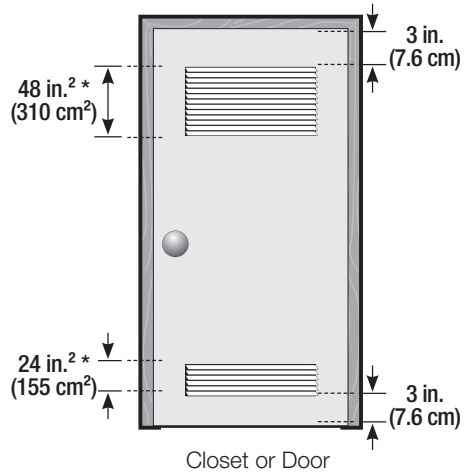
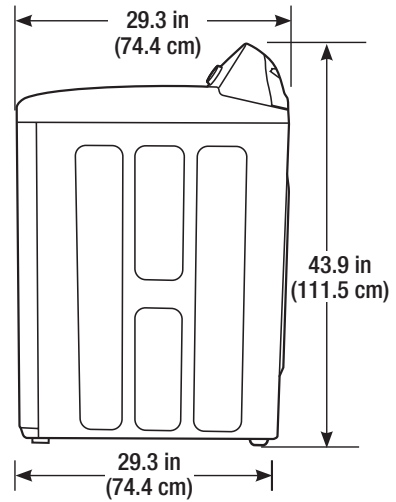
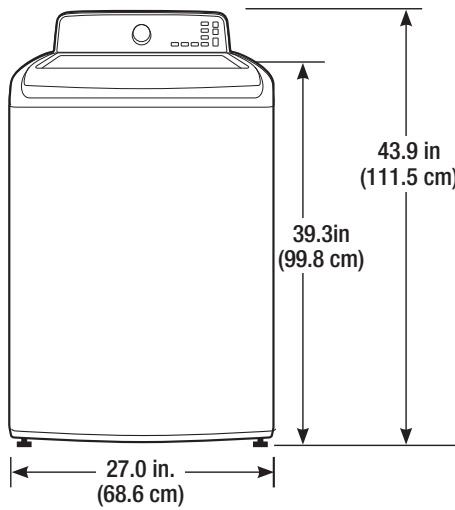

* Required spacing

IMPORTANT NOTE TO INSTALLER

Please read the following instructions carefully before installing your washer.

These instructions should be retained for future reference.

We recommend you hire a professional to install this washer.

STEP 1

Selecting a Location



Before you install the washer, make sure the location:

- Has a hard, level surface without carpeting or flooring that may obstruct ventilation.
- Is away from direct sunlight.
- Has adequate ventilation.
- Is not exposed to freezing temperatures (temperatures under 32 °F or 0 °C).
- Is away from heat sources such as oil or gas.
- Has enough space so that the washer doesn't rest on its power cord.

installing your washer

STEP 2

Connecting the water and the drain

Connecting the water supply hose

CAUTION Before installing the water supply hoses, make sure there are rubber gaskets inside the fittings at both ends of each new water hose. Installing the water supply hoses without rubber gaskets can cause water leakage.

CAUTION When you initially install the washer, be sure to use new hoses. Failing to do so may result in a water leakage or overflow and may damage your property.

CAUTION Do not connect multiple water supply hoses together to increase the length of the supply hose. Hoses connected this way can leak and the leakage can cause electrical shock. If a hose is too short, replace the hose with a longer, high pressure hose.

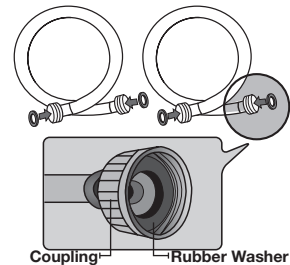

1. Connect the ends of the water supply hoses to the HOT and COLD faucets.
2. Tighten the fittings by hand until they are snug, and then tighten them an additional two-thirds of a turn with a wrench.

CAUTION When you fasten the fittings, do not fasten them too tightly or apply tape or sealant to the faucets or water supply intakes. This can damage the fittings.

 After you have connected the water supply hoses to the faucets, ensure that they are connected correctly by pulling the water supply hoses downwards

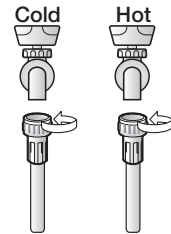

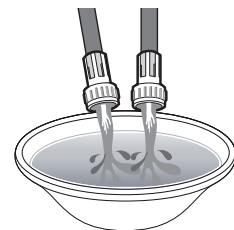

3. Place the unconnected ends of the hoses into a bucket and open the faucets connected to the two water supply hoses for 10 or 15 seconds to remove any foreign substances from the hoses. Close the faucets before continuing.
4. Connect the ends of the water supply hoses to the water supply intake connections at the back of the washer.



CAUTION The water supply hose connected to the HOT faucet must be connected to the hot water supply intake and the water hose connected to the COLD faucet must be connected to the COLD water supply intake.

5. Tighten the fittings by hand until they are snug, and then tighten them an additional two-thirds of a turn with a wrench.

 To ensure the correct water usage, connect both the HOT and COLD water faucets. If either or both are not connected, an "4E" (no fill) error can occur.

 If you do not want to use the HOT water supply hose, insert the water intake cap into the HOT water supply intake hole. In this case, you must select the Tap Cold option for the water temperature. If you select the Tap Cold option, all the lamps for the water temperature options are turned off.

CAUTION Confirm that the water supply hoses are not twisted or bent. If the hoses are twisted or bent, the hoses can leak and cause electric shock due to the water leakage.

6. Turn on the HOT and COLD water supplies and check all the water supply intake connections and the faucets for water leaks.

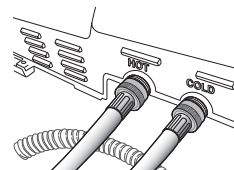
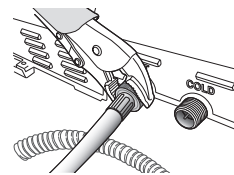
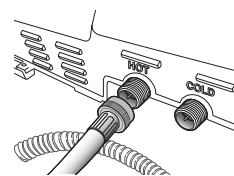

Connecting the drain hose

The end of the drain hose can be positioned in three ways:

Over the edge of a wash basin

Secure the guide to the side of the basin wall with a hook or to the tap with a piece of string to prevent the drain hose from moving.

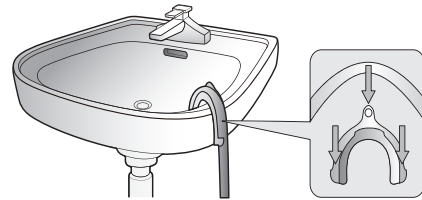

In a standpipe or laundry tub

The standpipe must be no shorter than 39 in (99 cm) and no longer than 96 in (245 cm).

-  Make sure that the connection between the drain hose and the standpipe is not airtight.

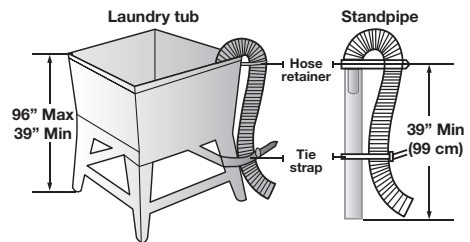

STEP 3

Leveling your washer

See if the washer is level by checking the position of the tub:

1. Slide the washer into position.
2. Open the lid of the washer, and pour the water into the tub to just below the pulsator level.

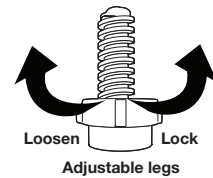
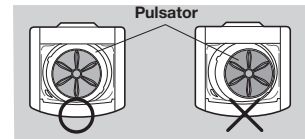

3. If the washer is level, the pulsator is positioned at the center of the water as shown in the figure. If not, level your washer by turning the front leveling feet clockwise or counterclockwise as necessary.

-  Turn the front leveling feet clockwise to raise the washer, and counterclockwise to lower the washer.

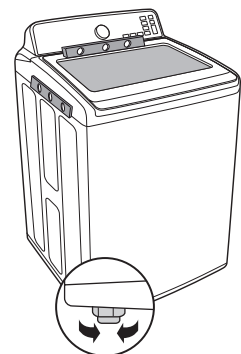

installing your washer

STEP 4

Powering your washer

Plug the power cord into a 3-prong, well grounded 220-240 volt 50 Hz approved electrical outlet protected by a 15-amp fuse or comparable circuit breaker.

Your washer is grounded through the third prong of the power cord when plugged into a three-prong grounded electrical outlet.

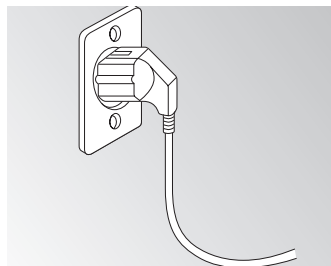

Test run

Make sure that you install your washing machine correctly by running the **Rinse+Spin** cycle after the installation is complete.

STEP 5

Running a test cycle

Run a test cycle as follows to check if your washer is properly installed.

1. Load about 6 pounds of laundry into the tub.
2. Press the **Power** button to turn on your washer.
3. Select the Rinse+Spin cycle by turning the **Cycle Selector**.
4. Press the **Start/Pause** button to start the test cycle.
5. The washer should not rock or vibrate excessively when water is supplied or when washing or spinning, and should drain well during the spin cycle.

 If water leaks while water is being supplied or drained, check the water connections. Refer to the “Connecting the water and the drain” section on pages 14~15 for instructions.

 If the washer rocks and vibrates excessively, level your washer again. Refer to the “Leveling your washer” section on page 15 for instructions.

STEP 6

Calibration mode

Your Samsung washing machine detects the laundry weight automatically.

For more accurate weight detection, please run Calibration Mode after the installation.

To run Calibration Mode, follow these steps:

1. Remove laundry or any contents in the machine and turn on the machine.
2. Press the Water Level and Wash buttons simultaneously, and then press the Power button. The machine turns on.
3. Press the **Start/Pause** button to activate “Calibration Mode”.
4. The pulsator rotates clockwise and counterclockwise for approximately 1 minute.
5. When “Calibration Mode” is finished, “End” appears on the display, and the machine automatically turns off. The washing machine is now ready for use.



operating instructions

 **WARNING:** To reduce the risk of fire, electric shock, or injury to persons when using your appliance, follow basic precautions, including the following:

LOADING YOUR WASHER

- You can fill the tub with dry, unfolded clothes, but **DO NOT OVERLOAD** the tub, No more than 3/4 full.
 - Overloading may reduce washing efficiency, cause excess wear, and possibly cause creasing or wrinkling of the load.
 - Wash delicate items such as bras, hosiery, and other lingerie in the Delicates/Hand Wash cycle with similar lightweight items.
 - When washing big bulky items or a few smaller items that don't fill the tub completely – a rug, a pillow, stuffed toys, or one or two sweaters, for example – add a few towels to improve spin performance.
 - Do not insert bulky items except for Bedding in this cycle.
-  During the spin cycle, the washer may add additional water to redistribute the clothes and correct an imbalance inside the drum.
- When washing heavily soiled loads, do not overload your washer to ensure good cleaning results.
 - To add a forgotten item:
 1. Press the **Start/Pause** button to pause the washer.
 2. Wait for the door to unlock automatically, and then open the door.
 3. Add the item, close the door, and then press the **Start/Pause** button. The cycle will resume.

GETTING STARTED

1. Load your washer.
 2. Add liquid (or powder) detergent and additives to the dispenser (see pages 24–25).
 3. Select the appropriate cycle and options for the load (see pages 18–23).
 4. Close the lid.
 5. Press the **Start/Pause** button.
 6. The Wash Indicator light illuminates.
 7. The estimated cycle time will appear in the display.
The time may fluctuate to indicate the time remaining in the cycle better.
-  The actual time required for a cycle may differ from the estimated time in the display depending on the water pressure, water temperature, detergent, and laundry.
8. Before your washer starts to fill, it will make a series of clicking noises to check the door lock and do a quick drain.
- 
- When the cycle is complete, the Door Lock light will go out and “End” will appear in the display.
 - Pressing the **Power** button cancels the cycle and stops your washer.
 - The Wash, Rinse, and Spin indicator lights will illuminate during those portions of the cycle.

washing a load of laundry

OVERVIEW OF THE CONTROL PANEL

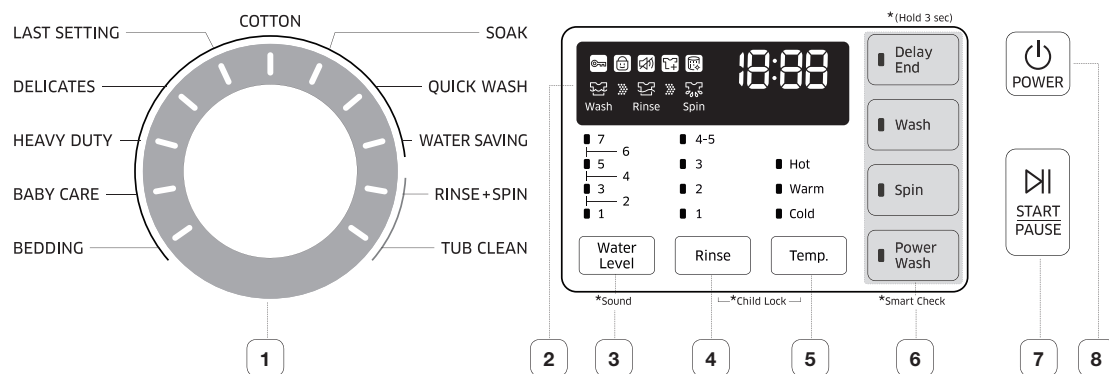

1 Cycle Selector

Select the appropriate cycle for the type of load.

The cycle you select determines the tumble pattern and spin speed for the cycle.

To minimize wrinkling of laundry, select the Perm Press cycle.

COTTON - For averagely or lightly soiled cotton, bed linen, table linen, underwear, towels, shirts, etc.

LAST SETTING - Selects this cycle to load the settings for the last cycle. Perform a wash cycle using the last used settings without having to enter them manually again. Your choices are automatically saved when you press the Start/Pause button. To use a memorized cycle, press the Last Setting button and then press the Start/Pause button.

DELICATES - For sheer fabrics, bras, lingerie, silks, and other handwash-only fabrics. For best results, use liquid detergent.

HEAVY DUTY - For sturdy, colorfast fabrics and heavily soiled garments.

BABY CARE - This cycle washes frequently washed items such as baby clothes and underwear to prevent damage to the fabric and adds extra rinse cycles to ensure cleanness.

BEDDING - For bulky items such as blankets and sheets. When you are washing comforters, use liquid detergent.

SOAK - Remove stains more thoroughly by specifying additional time.

QUICK WASH - For lightly soiled garments needed quickly.

WATER SAVING - This is a specially designed cycle that enables you to wash laundry effectively with the minimum amount of water.

For WA10H7200**: Water saving, Wash 20 min, Spin 12 min, Warm, Rinse 3, Water level 7 is the program recommended for a normally soiled cotton load.

For WA90H7000**: Water saving, Wash 20 min, Spin 12 min, Cold, Rinse 3, Water level 6 is the program recommended for a normally soiled cotton load.

Energy and water labelling test programme in accordance with AS/NZS 2040.

RINSE + SPIN - Use for loads that need rinsing only or to add rinse-added fabric softener to a load.

TUB CLEAN - Use to clean dirt and bacteria from the tub. Regular use (after every 20 washes) is recommended. No detergent or bleach is needed (see page 29).

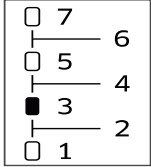
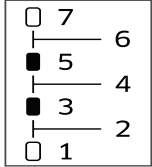
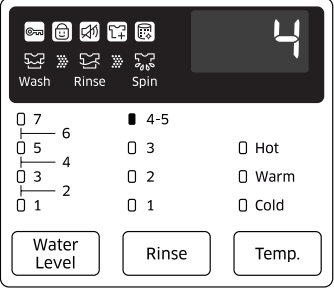
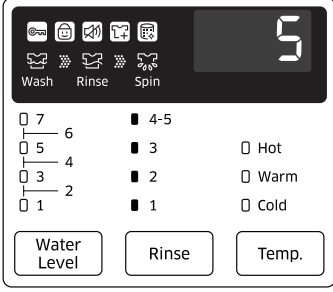
2 Display	Provides instructions and diagnostics while keeping you updated on the cycle status and time remaining.
3 Water Level selection button	<p>The water level is automatically adjusted. However, you can select the water level manually by pressing this button.</p> <p>According to the texture and humidity of clothes, water level and water consumption may differ.</p> <div style="display: flex; justify-content: space-around; align-items: flex-start;"> <div style="text-align: center;"> <p>Ex)</p>  <p>Water Level: 3</p> </div> <div style="text-align: center;">  <p>Water Level: 4</p> </div> </div>
4 Rinse selection button	<p>Press to change the rinse times for the current course. You can set the rinse times up to 5.</p> <div style="display: flex; justify-content: space-around; align-items: flex-start;"> <div style="text-align: center;"> <p>Ex)</p>  <p>Rinse: 4</p> </div> <div style="text-align: center;">  <p>Rinse: 5</p> </div> </div>
5 Temp. selection button	<p>Press the button repeatedly to cycle through the different water temperature options.</p> <p>Hot - Whites and heavily soiled, colorfast items. Warm - Colorfast items. Cold - Brightly colored, very lightly soiled items.</p>
6 Select Cycle Option	<p>Press these buttons to select different cycle options.</p> <p>Delay End - Delay the end of any cycle for up to 19 hours in one-hour increments. Displayed hour indicates the time the wash will be ended.</p> <p>Wash - Press this button to only perform a wash cycle or to adjust the wash time.</p> <p>Spin - Press this button to perform a spin cycle only or to adjust the spin time. You can set the spin time from between 1 to 9 minutes. When only a spin is selected, the spin time will be different from the total remaining time. This is because the total remaining time includes the actual spin time and the times for water draining and stopping.</p> <p>Power Wash - By adding additional water to your machine, this function assists in the washing & rinsing performance of your chosen cycle.</p>
7 Start/Pause selection button	Press to pause and restart cycles.
8 Power button	Press once to turn your washer on. Press again to turn your washer off. If the washer is left on for more than 10 minutes without any buttons being touched, the power automatically turns off.

washing a load of laundry

Child Lock [🔒]

Child Lock prevents children from playing with your washer.

Activating the Child Lock function

Press and hold the **Rinse** and **Temp.** buttons simultaneously for approximately 3 seconds.

- When you activate the Child Lock function, the “Child Lock [🔒]” lamp blinks.

Using the Child Lock function

If the lid is opened when the Child Lock function is on, “dE” is displayed and an alarm sounds.

- If the lid is closed while “dE” is displayed, the alarm sound stops and the information code turns from “dE” to “CL”.
- If the water level in the tub is above the safe water level, “dE” is displayed on the LED display and the washing machine starts to drain water by force after 30 seconds.
- If the water level in the tub is above the safe water level and the Child Lock function is turned on while the door is open, “CL” is displayed on the LED display even if the power of the washing machine is turned off and the washing machine drains water by force.
- Even if the power of the washing machine is turned off, if the lid is opened while the water level in the tub is above the Reset water level, “CL” is displayed on the LED display without the alarm sounding and the washing machine starts to drain water. When the draining operation finishes, the power is automatically turned off again.
- After the compulsory drain, the “CL” code display blinks at 1 second intervals and the product enters the “CL” mode. (When the product is in the “CL” mode, only the **Power** button works.)
- To cancel the “CL” mode, you need to turn the power off and then on again.
- To cancel the “dE” mode, deactivate the Child Lock function. To deactivate the Child Lock function, press and hold the **Rinse** and the **Temp.** buttons simultaneously for at least 3 seconds.

Adding laundry when Child Lock is on

- To add laundry, deactivate the Child Lock function. To deactivate the Child Lock function, press and hold the **Rinse** and the **Temp.** buttons simultaneously for at least 3 seconds. See “Pause Option” on page 23 for additional details.

Deactivating the Child Lock function

Press and hold both the **Rinse** and **Temp.** buttons simultaneously for approximately 3 seconds.

- When you deactivate the Child Lock function, the “Child Lock [🔒]” is turned off.
- The Child Lock function prevents children or the infirm from accidentally operating the washer and injuring themselves.



- If a child enters the washing machine, the child may become trapped and suffocate.



- Once you have activated the Child Lock function, it continues working even if the power is turned off.
- Forcing the lid open can result in injury or damage to the product.



To add laundry after you have activated the Child Lock function, you must first pause or deactivate the Child Lock function.

Sound

The Sound Off function can be selected during all cycles. When this function is selected, sound is turned off for all cycles. Even if the power is turned on and off repeatedly, the setting is retained.

Garment+

You can add or take out laundry items even after the wash has started, as long as the “” light is on. Pushing the **Start/Pause** button unlocks the lid. If you open the lid and want to continue the wash cycle, close the lid, and then press the **Start/Pause** button.



If you have activated Child Lock, you must deactivate it first. See page 20.

Delay End

You can set the washing machine to start your wash automatically at a later time, by choosing a delay time.

The hour displayed indicates the time at which the wash will be ended.

1. Set your wash cycle.
2. Press the **Delay End** button repeatedly until the delay time is set.
3. Press the **Start/Pause** button. The “Delay End” indicator will be lit, and the clock will begin counting down until it reaches the set time.
4. To cancel a Delay End function, press the **Power** button and then turn the washing machine on again.

Wash

Press this button to only perform a wash cycle or to adjust the wash time.

Spin

Press this button to perform a spin cycle only or to adjust the spin time.

You can set the spin time from between 1 to 9 minutes.

When only a spin is selected, the spin time will be different from the total remaining time. This is because the total remaining time includes the actual spin time and the times for water draining and stopping.

Power Wash

After supplying additional water, the drum rotation creates a waterfall that dissolves the detergent thoroughly. This allows the detergent to penetrate more evenly into the clothes and remove stains effectively, even on big loads, giving you a better wash, during the rinse cycle, the waterfall passes through the fabric, removing detergent residue thoroughly.

Cycles	Power Wash Function
Cotton, Heavy Duty, Soak, Quick Wash	Available
Delicates, Baby Care, Water Saving, Rinse+Spin, Tub Clean	Not Available
Bedding	Default

washing a load of laundry

Mist Shower

Mist Shower sprays water from a nozzle that is independent of the main water supply system. This soaks the laundry with water from the beginning of the wash cycle and ensures an effective wash even with a small amount of water.

(The Mist Shower function may not work if there are too many laundries.)

Smart Check

This function enables you to check the status of the washing machine using a smartphone.

1. To enable the Smart Check function, press and hold the Power Wash key for 3 seconds after turning the power on or when an error occurs.
 - The error code history is deleted after you use this function.
2. The Smart Check indicator is lit on the display.
3. Run the Smart Care app on your smart phone.
 - GalaxyS, GalaxyS2, GalaxyS3, GalaxyS4, GalaxyS2(HD), Galaxy Note, Galaxy Note2, Galaxy Note3 (Other devices may not be normal operation).
Supported operating system: Android 2.2 or higher
 - iPhone 3 G S, iPhone 4/4S, iPhone 5/5S.
Supported operating system : OS 4.3 or higher
4. Focus your smart phone's camera on the display panel of the washing machine.
5. If the smart phone's camera is focused on the display panel of the washing machine, the panel and error message is automatically recognized and the error type and countermeasures are displayed on the smart phone.
6. If the smartphone fails to recognize the error code more than twice, please enter the error code displayed on the display panel of the washer manually into the Smart Check app.



Downloading the Smart Check app

- Download the Samsung Laundry App into your mobile phone from the Android market or Apple App store. (Search word : Samsung Smart Washer/Dryer)



Precautions when using Smart Check

- If light from a light bulb, fluorescent bulb, or lamp is reflected on the display panel of the washing machine, the smartphone may not be able to recognize the panel or error message easily.
- If you hold the smartphone at too large an angle relative to the front of the display panel, it may not be able to recognize the error code. For best results, hold the smartphone so that the front of the panel and the smartphone are parallel or nearly parallel.

Washing clothes using the cycle selector

Your new washing machine makes washing clothes easy, using Samsung's "Fuzzy Control" automatic control system. When you select a wash program, the machine will set the correct temperature, washing time, and washing speed.

1. Press the **Power** button.
2. Open the lid.
3. Load the articles of clothing one at a time loosely into the drum, without overfilling it.
4. Add liquid (or powder) detergent, softener, if necessary to the appropriate compartments. See pages 24~25.
5. Close the lid.
6. Use the Cycle Selector to select the appropriate cycle according to the type of material: COTTON, SOAK, QUICK WASH, WATER SAVING, RINSE+SPIN, TUB CLEAN, DELICATES, HEAVY DUTY, BABY CARE, BEDDING. The relevant indicators will illuminate on the control panel.
7. At this time, you can control the wash temperature, the number of rinse cycles, the spinning speed, and the delay time by pressing the appropriate option button.
8. Press the **Start/Pause** button on the Cycle Selector and the wash will begin. The process indicator will light up and the remaining time for the cycle will appear in the display.

Pause Option

When the Garment + LED is on, you can add laundry items to or remove laundry items from the wash.

To remove or add laundry items when the Garment + LED is on, follow these steps:

1. Press the **Start/Pause** button to unlock the lid.
 If you have Child Lock on, you must deactivate it first. See page 20.
The lid cannot be opened when the water is too HOT.
2. Remove or add laundry items.
3. Close the lid, and then press the **Start/Pause** button to restart the wash.



When the cycle is finished:

After the total cycle has finished, the power will turn off automatically.

1. Open the lid.
2. Remove laundry.

washing a load of laundry

DETERGENT USE

- The use a good quality top loader detergent is recommended.
 - It is also important to:
 - Pre-treat stains before washing.
 - Sort clothes by color.
 - Sort clothes by the amount of soiling.
 - Avoid overloading.
-  When using powdered detergent it is recommended that the powder be dissolved in warm water to ensure optimum cleaning results.
-  The detergent/water mixture can be added to either the tub or to the detergent dispenser tray.
-  Reducing the amount of detergent used may reduce the effectiveness of the cleaning action.



FEATURES

Automatic dispenser

Your washer has separate compartments for dispensing detergent and fabric softener. Add all laundry additives to their respective compartments before starting your Washer.

The automatic dispenser **MUST ALWAYS** be in place before you start your washer.

DO NOT open the automatic dispenser when your washer is running.

-  • Never exceed the manufacturer's recommendations when adding detergent.
-  • This compartment holds liquid detergent for the main wash cycle, which is added to the load at the beginning of the cycle.
- When using powdered detergent, remove the liquid detergent compartment from the detergent drawer. The washer will not dispense powdered detergent from the liquid detergent compartment.

To add detergent to the automatic dispenser:

1. Open the dispenser drawer.
2. Load the recommended amount of liquid (or powder) detergent into the detergent compartment before you start your wash.
3. Close the drawer slowly and smoothly to avoid spilling, splashing, or premature dispensing of the contents.

-  It is normal for a small amount of water to remain in the dispenser compartments at the end of the cycle.

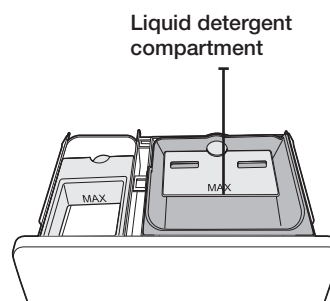

Loading the Liquid (or Powder) detergent compartment

1. Pour the recommended amount of laundry detergent directly into the detergent compartment before starting your washer.



When using powdered detergent, remove the liquid detergent compartment from the detergent drawer. The washer will not dispense powdered detergent from the liquid detergent compartment.

Liquid detergent compartment

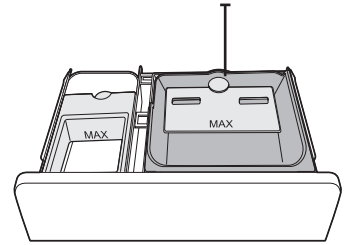

Loading the Fabric softener compartment

1. Pour the recommended amount of liquid fabric softener into the softener compartment. For smaller loads, use less than one capful.
2. Dilute the fabric softener with water until it reaches MAX FILL in the compartment.
3. The dispenser automatically releases liquid fabric softener at the proper time during the rinse cycle.



- Use the softener compartment **ONLY** for liquid fabric softeners.
 - **DO NOT** use the Downy Ball* in the fabric softener compartment with this washer. It will not add fabric softener at the appropriate time. Use the detergent compartment.
 - Do not use liquid fabric softener that is too sticky as it may not mix with the water sufficiently.
- * Brand names are trademarks of their respective manufacturers.

Fabric softener compartment

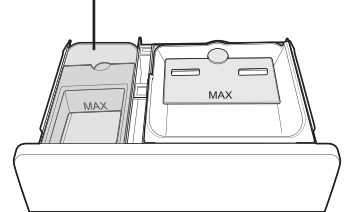

maintaining your washer

CLEANING THE EXTERIOR

Turn off the water faucets after finishing the day's washing.

This will shut off the water supply to your washer and prevent the unlikely possibility of damage from escaping water. Leave the lid open to allow the inside of your washer to dry out.

Use a soft cloth to wipe up all detergent, bleach or other spills as they occur.

Clean the following as recommended:

Control Panel – Clean with a soft, damp cloth. Do not use abrasive powders or cleaning pads. Do not spray cleaners directly on the panel.

CLEANING THE INTERIOR

Clean the interior of your washer periodically to remove any dirt, soil, odor, mold, mildew, or bacterial residue that may remain in your washer as a result of washing clothes.

Failure to follow these instructions may result in unpleasant conditions, including odors and/or permanent stains on your washer or laundry.

Hard water deposits may be removed, if needed. Use cleaners labeled "Washer safe".

STORING YOUR WASHER

Washers can be damaged if water is not removed from hoses and internal components before storage.

Prepare your washer for storage as follows:

- Select the Quick Wash cycle and add bleach to the automatic dispenser. Run your washer through the cycle without a load.
- Turn the water faucets off and disconnect the inlet hoses.
- Unplug your washer from the electrical outlet and leave your washer lid open to let air circulate inside the drum.
- If your washer has been stored in below-freezing temperatures, allow time for any leftover water in your washer to thaw out before use.

PRESERVING THE TOP COVER AND THE FRONT FRAME

Do not place any heavy or sharp objects or a detergent box on the washing machine. They can scratch or damage the top cover of the unit.

 Since the entire washing machine has a high-gloss finish, the surface can be scratched or damaged. Avoid scratching or damaging the surface when using the washing machine.

CLEANING THE FILTER

Diamond (magic) filter screen

1. Press your thumb on the upper bayonet of Diamond (magic) filter screen, then push down and pull outward to open the cover.

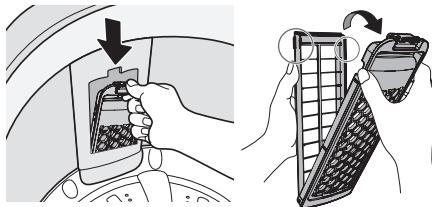

2. Remove the residues.

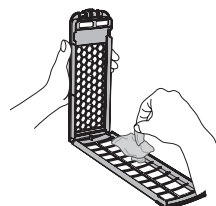

3. Clean with water.

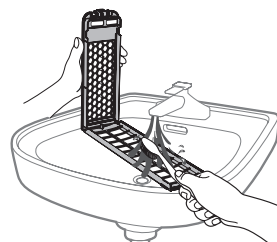

4. Reassembly the Diamond (magic) filter screen.

Point the bottom of filter screen to the water guide and snap into place. Then snap the upper filter screen into water guide [till you hear the sound of "click"].

Be careful to discriminate the front and back when snapping into place.

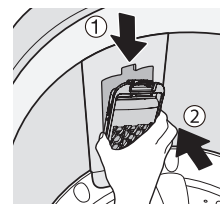

-  If the mesh of Diamond (magic) filter screen is blocked, foreign objects will stick on the washings. In order to ensure the clothes are well cleaned, clean the filter screen frequently each week and keep less than 50% of the filter screen occupied by residues.

maintaining your washer

CLEANING THE DISPENSERS

The automatic dispenser may need to be cleaned periodically due to laundry additive buildup.

1. Pull the dispenser drawer straight back until it stops.

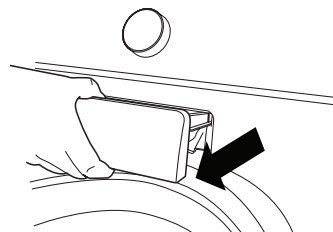

2. Tilt the dispenser drawer upward and remove it.

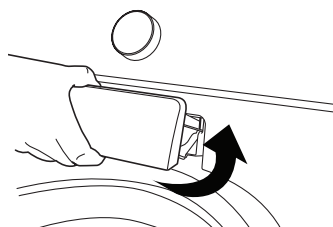

3. Remove the inserts from the 3 compartments. Rinse the inserts and the drawer with warm water to remove traces of accumulated laundry products.

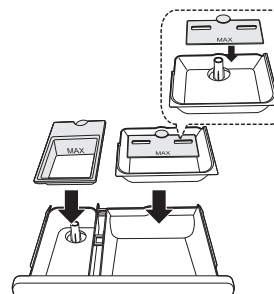

4. To clean the drawer opening, use a small, non-metal brush to clean the recess. Remove all residue from the upper and lower parts of the recess.

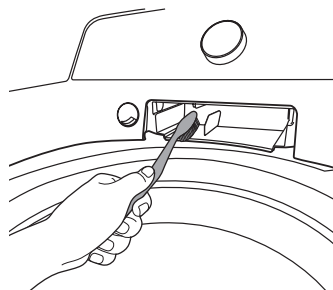

5. Return the inserts to the proper compartments and replace the drawer. By placing the dispenser drawer rail ② on top of the compartment rail ① (Tilt the dispenser drawer downward and insert it.), and then pushing the drawer in firmly and slowly.

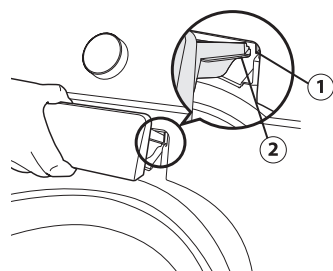

TUB CLEAN

Tub Clean is a self-cleaning cycle that removes mold that may occur inside the washing machine.

1. Press the **Power** button.
2. Select the **Tub Clean** cycle.
 - Once the Tub Clean cycle is selected, the only function that can be set is Delay End.
3. Press the **Start/Pause** button.
 - If you press the **Start/Pause** button, Tub Clean begins.

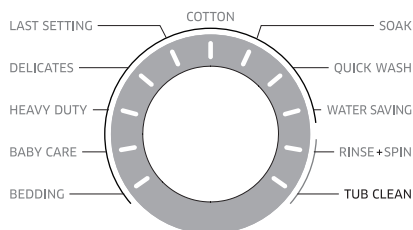

CAUTION

- Using Tub Clean, you can clean the tub without using a cleansing agent.
- Never use Tub Clean when laundry is in the washing machine. This may cause damage to the laundry or a problem with the washing machine.



The Tub Clean Auto Indicator Function

- If the “**Tub Clean**” is lit after a wash, it indicates that tub (drum) cleaning is required. In this case, remove the laundry from the washing machine, turn the power on, and clean the tub by running Tub Clean.
- If you do not run Tub Clean, the “**Tub Clean**” indicator turns off. However, the “**Tub Clean**” indicator will light again after two washes. Not running Tub Clean at this point will not cause a problem with the washing machine.
- Although the Tub Clean Auto Indicator appears once a month or so, the frequency may differ depending on the number of times the washing machine is used.

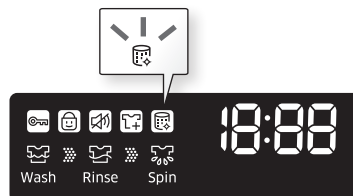

troubleshooting

CHECK THESE SOLUTIONS IF YOUR WASHER...



PROBLEM	SOLUTION
Will not start.	<ul style="list-style-type: none">• Make sure the lid is closed.• Make sure your washer is plugged in.• Make sure the water source faucets are open.• Make sure to press the Start/Pause button to start your Washer.• Make sure Child Lock is not activated. See page 20.• Before your washer starts to fill, it will make a series of clicking noises to check the lid lock and do a quick drain.• Check the fuse or reset the circuit breaker
Has no water or not enough water.	<ul style="list-style-type: none">• Turn both faucets on fully.• Straighten the water inlet hoses.• Disconnect hoses and clean the screens. Hose filter screens may be clogged.
Has detergent remaining in the automatic dispenser after the wash cycle is complete.	<ul style="list-style-type: none">• Make sure your washer is running with sufficient water pressure.
Vibrates or is too noisy.	<ul style="list-style-type: none">• Make sure your washer is set on a level surface. If the surface is not level, adjust your washer's feet to level the appliance.• Make sure your washer is not touching any other object.• Make sure the laundry load is balanced.
Stops	<ul style="list-style-type: none">• Plug the power cord into a live electrical outlet.• Check the fuse or reset the circuit breaker.• Close the lid and press the Start/Pause button to start your washer. For your safety, your washer will not spin unless the lid is closed.• Before your washer starts to fill, it will make a series of clicking noises to check the lid lock and do a quick drain.• There may be a pause or soak period in the cycle. Wait and it may start.• Check the screens on the inlet hoses at the faucets for obstructions. Clean the screens periodically.
Foreign objects stuck on the clothes	<ul style="list-style-type: none">• During rinsing, increase the water level by using Water Level button to ensure clothes are submerged.• Clean magic filter screen often.• Wash colour items separately (Wash white and black clothes separately).• Select corresponding mode according to the category of washings. For example, select BEDDING mode for bed sheet.• Execute TUB CLEAN mode to clean foreign objects in the drum.

PROBLEM	SOLUTION
Fills with the wrong temperature water.	<ul style="list-style-type: none"> • Turn both faucets on fully. • Make sure the temperature selection is correct. • Make sure the hoses are connected to the correct faucets. Flush water lines. • Disconnect the hoses and clean the screens. The hose filter screens may be plugged. • As your washer is filling, the water temperature may change as the automatic temperature control feature checks incoming water temperature. This is normal. • While your washer is filling, you may notice just hot and/or just cold water going through the dispenser when you have selected cold or warm wash temperatures. This is a normal function of the automatic temperature control feature as your washer determines the temperature of the water.
Lid locked or will not open.	<ul style="list-style-type: none"> • Press the Start/Pause button to stop your washer. • It may take a few moments for the lid lock mechanism to disengage.
Does not drain and/or spin.	<ul style="list-style-type: none"> • Check the fuse or reset the circuit breaker. • Straighten the drain hoses. Eliminate kinked hoses. If there is a drain restriction, call for service. • Close the lid and press the Start/Pause button. For your safety, your washer will not spin unless the lid is closed.
Load is too wet at the end of the cycle.	<ul style="list-style-type: none"> • Use the High spin speed. • Use high efficiency detergent to reduce over-sudsing. • The Load is too small. Very small loads (one or two items) may become unbalanced and not spin out completely.
Leaks water.	<ul style="list-style-type: none"> • Make sure all hose connections are tight. • Make sure the end of the drain hose is correctly inserted and secured to the drainage system. • Avoid overloading. • Use high efficiency detergent to prevent over-sudsing.
Has excessive suds.	<ul style="list-style-type: none"> • Use high efficiency detergent to prevent over-sudsing. • Reduce the detergent amount for soft water, small or lightly soiled loads. • Non-HE detergent is NOT recommended.

troubleshooting

INFORMATION CODES

The Washer may display information codes to help you understand what is occurring with your Washer better.

CODE SYMBOL	MEANING	SOLUTION
1E	The Water Level sensor is not working properly.  When washer displays "1E", washer will drain for 3 minutes. At this time, the Power button is invalid	Call for service.
4E	Your Washer has tried to fill but was unsuccessful. Check if the hot water supply hose is connected.  When washer displays "4E", washer will drain for 3 minutes. At this time, the Power button is invalid.	Make sure the water faucets are open all the way. Check for kinked hoses. Check the inlet screens on the fill hoses. If you use a Flood Safety Device, then please remove the device and connect the water hoses directly to the unit. You must connect the hot water supply hose because hot water is supplied by the Auto Temperature Control (A.T.C.) function.
5E	Your washer is not draining. It can also mean that the unit senses a small clog while draining.	Do the following: 1) Turn off the unit and turn it on again. 2) Select only the Spin Cycle. 3) Press the Start/Pause to drain the water. If it still does not drain, call for service.
LE	Your Washer has tried to fill but has not reached the proper water level.  When washer displays "LE", washer will drain for 3 minutes. At this time, the Power button is invalid.	Call for service.
UE	Unbalanced load prevented your Washer from spinning.	Redistribute the load, press the Start/Pause button.
dE	Lid is open when washer is running.	Close the lid tightly and restart the cycle. If the code reappears, call for service.
dE1	Your washer failed to lock or unlock the lid.	Close the lid tightly and restart the cycle. If the code reappears, call for service.
dE1	The door will not unlock.	Make sure the lid is firmly closed. Push the Power button to turn off your washer, then turn it on again. If the code reappears, call for service.
bE2	A jammed Key.	Call for service.
3E	Motor not running properly.	Restart the cycle pressing the Start/Pause button. If the code reappears, call for service.
AE	Communication error between SUB PBA and MAIN PBA.	Call for service.



































CODE SYMBOL	MEANING	SOLUTION
8E 8E2	Mems sensor problem.	Call for service.
tE1	Temperature sensor problem.	Restart the cycle. If the code reappears, call for service.
OE	A fault is detected in the water level sensor.	Call for service.
4E2	This occurs when the temperature exceeds 50 degrees for over 8 seconds in the Wool and Delicates cycle.	Call for service.

For any codes not listed above, call 1300 362 603.

appendix

FABRIC CARE CHART

The following symbols provide garment care direction. The Clothing care labels include symbols for washing, bleaching, drying and ironing, or dry cleaning when necessary. The use of symbols ensures consistency among garment manufacturers of domestic and imported items. Follow care label directions to maximize garment life and reduce laundering problems.

Wash Cycle		Special Instructions		Warning Symbols for Laundering	
	Cotton		Line Dry/ Hang to Dry		Do Not Wash
	Permanent Press / Wrinkle Resistant / Wrinkle Control		Drip Dry		Do Not Wring
	Gentle/Delicates		Dry Flat		Do Not Bleach
	Hand Wash	Heat Setting			Do Not Tumble Dry
Water Temperature**			High		No Steam (added to iron)
	Hot		Medium		Do Not Iron
	Warm		Low	Dryclean	
	Cold		Any Heat		Dry Clean
Bleach			No Heat/Air		Do Not Dry Clean
	Any Bleach (when needed)	Iron-Dry or Steam Temperatures			Line Dry/ Hang to Dry
	Only Non-Chlorine (color-safe) Bleach (when needed)		High		Drip Dry
	Tumble Dry Cycle		Medium		Dry Flat
Normal			Low		
	Permanent Press/ Wrinkle Resistant/ Wrinkle Control				
	Gentle/ Delicates				

** The dot symbols represent appropriate wash water temperatures for various items. The temperature range for Hot is 105° - 125 °F / 41° - 52 °C, for Warm 85° - 105 °F / 29° - 41 °C and for Cold 60° - 85 °F / 16° - 29 °C. (Wash water temperature must be a minimum of 60 °F / 16 °C for detergent activation and effective cleaning.) The clothes washer can not ensure these temperatures because the actual temperature of the water entering your washer depends on water heater settings and regional water supply temperatures. For example, cold water entering the home in the northern states during winter may be 40 °F / 4 °C which is too cold for effective cleaning. In this situation, you will need to adjust the water temperature by selecting a warm setting, adding some hot water to the MAX FILL line, or using your Washer's heating option, if available.

CYCLE CHART

Use this chart to set the best cycle and options for you laundry.

(●: factory setting, ●: selectable)

Cycle	Functions										
	Water Level							Rinse (1-5)	Temp.		
	1	2	3	4	5	6	7		H	W	C
COTTON	●	●	●	●	●	●	●	2	●	●	●
DELICATES	●	●	●	●	●	●	●	2		●	●
HEAVY DUTY	●	●	●	●	●	●	●	2	●	●	●
BABY CARE	●	●	●	●	●	●	●	3	●	●	●
BEDDING	●	●	●	●	●	●	●	3	●	●	●
SOAK	●	●	●	●	●	●	●	2	●	●	●
QUICK WASH	●	●	●	●	●	●	●	2	●	●	●
WATER SAVING	●	●	●	●	●	●	●	2	●	●	●
RINSE+SPIN	●	●	●	●	●	●	●	1	●	●	●
TUB CLEAN				●				1		●	

Cycle	Options			
	Delay End	Wash	Spin	Power Wash
COTTON	●	●	●	●
DELICATES	●			
HEAVY DUTY	●	●	●	●
BABY CARE	●	●	●	
BEDDING	●	●	●	●
SOAK	●	●	●	●
QUICK WASH	●	●	●	●
WATER SAVING	●	●	●	
RINSE+SPIN	●		●	
TUB CLEAN	●			

Water Level	Rinse	Temp.
1		
2		
3	1	
4	2	
5	3	
6	4-5	
7		

H: Hot
W: Warm
C: Cold

appendix

HELPING THE ENVIRONMENT

- Your washer is manufactured from recyclable materials. If you decide to dispose of it, please observe local waste disposal regulations. Cut off the power cord so that the appliance cannot be connected to a power source. Remove the lid so that animals and small children cannot get trapped inside the appliance.
- Do not exceed the detergent quantities recommended in the detergent manufacturers' instructions.
- Use stain removal products and bleaches before the wash cycle only when necessary.
- Save water and electricity by only washing full loads (the exact amount depends upon the program used).

DECLARATION OF CONFORMITY

This appliance complies with European safety standards, EC directive 93/68 and EN Standard 60335.

SPECIFICATION

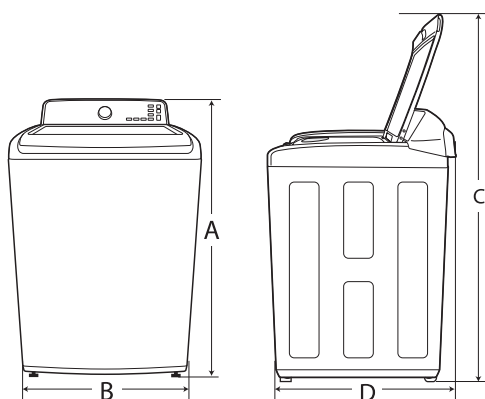

TYPE		TOP LOADING WASHER	
DIMENSIONS	Div		Inches (cm)
	A. Height		43.9" (111.5)
	B. Width		27.0" (68.6)
	C. Height with lid open		58.1" (147.6)
D. Depth		29.3" (74.4)	
WATER PRESSURE		20-116 psi (137-800 kPa)	
WEIGHT	WA10H*	57.0 kg (125.7 lb)	
	WA90H*	56.0 kg (123.5 lb)	
POWER CONSUMPTION	WASHING	230 V	700 W
	SPIN	230 V	300 W
	DRAIN	230 V	80 W
SPIN REVOLUTION		800 rpm	

memo

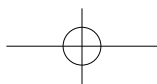
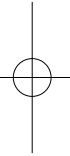
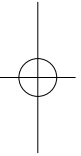
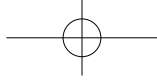

memo

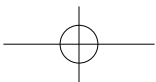
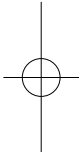
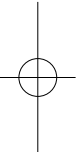
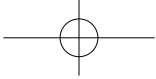

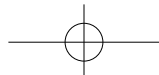
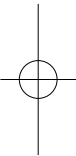
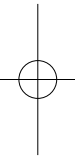
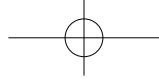



QUESTIONS OR COMMENTS?

Country	CALL	OR VISIT US ONLINE AT
AUSTRALIA	1300 362 603	www.samsung.com/au/support



Code No. DC68-03133X_EN