

Indoor Unit Operation & Installation Manual

MVAD007MV2AA

MVAD009MV2AA

MVAD012MV2AA

MVAD018MV2AA

MVAD024MV2AA

No. 0150519177

- Please read this manual carefully before using.
- Keep this operation manual for future reference.

Original instructions



User Manual

CONTENTS

Parts and Functions.....	1
Safety	2
Maintenance	4
Fault Checkup	5
Installation Procedures.....	6
Electrical Wiring.....	11
Test Run & Failure Code	17

MRV series multi zone air conditioning systems can operate multiple indoor units in heating or cooling. When in cooling, only units set to cool will run. Same logic applies for heating..

Turn power on for 12 hours prior to start-up to allow the crankcase heater adequate time to protect the compressor.

All indoor units on the same refrigeration system should use the unified power switch to ensure that all indoor units are all powered on during system operation.

Features:

1. Low static pressure indoor units.
2. Space saving design.
3. System automatically displays any diagnostic error codes.
4. Brushless DC motor for improved energy efficiency.
5. Five fan speeds with a quiet operation mode.
6. Wider range of ESP: 0-0.12in.W.G.(0-30Pa).
7. Centralized controller function (optional from our company).
8. If there is a power outage during while the system is operating, the system will resume the last mode and settings it was set to run in.
9. This indoor unit only has a wired controller option.

Operating Range

		Max.	DB: 89.6°F (32°C)	WB: 73.4°F (23°C)
Cooling Dry	Indoor	Min.	DB: 64.4°F (18°C)	WB: 57.2°F (14°C)
		Outdoor	Max.	DB: 109°F (43°C)
	Min.		DB: 23°F (-5°C)	
	Heating	Indoor	Max.	DB: 80.6°F (27°C)
Min.			DB: 59°F (15°C)	
Outdoor		Max.	DB: 69.8°F (21°C)	WB: 59°F (15°C)
		Min.	DB: 5°F (-15°C)	

Parts and Functions

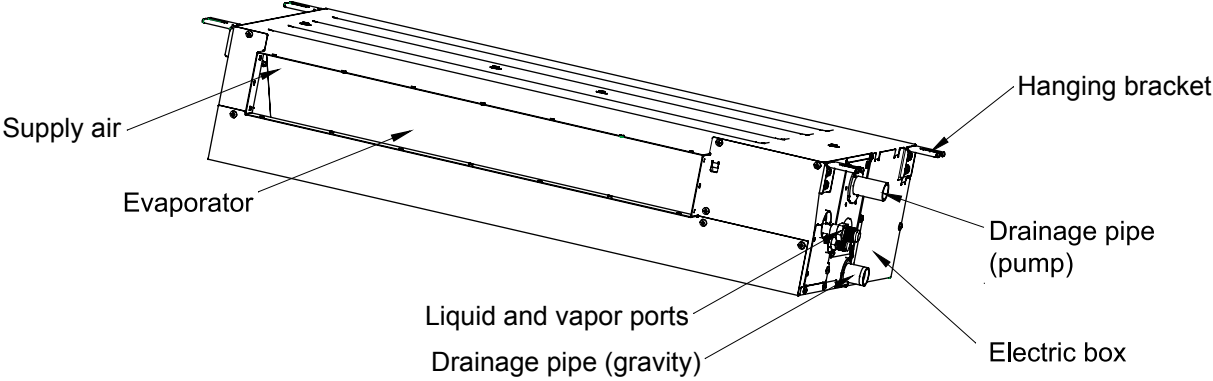

Safety

- This manual should be saved and stored close to this air conditioning equipment.
- There are two types of indications. Both are related to safety and should be strictly followed. "⚠Warning" highlights issues that pose a risk of major injury or death. "⚠Caution" highlights issues that pose a risk of equipment or bodily injury.
- After installation and start-up commissioning, please give the manual to the user. The manual should be kept in safe place and close to the unit.

⚠WARNING











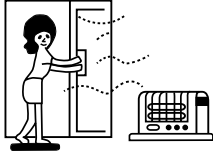



- Installation and maintenance should be performed by an authorized agency. The wrong operation of this air conditioning equipment may cause water damage, electric shock or fire.
- Please install the unit on the top of a solid foundation or structure which is strong enough to support the unit.
- The installation of this air conditioning equipment should follow local building codes.
- Use the right cable size, secure the terminal firmly, organize the cables well and make sure no tension is added on cables. Cable insulation should not be damaged. Improper wire installation may lead to fire.
- This unit is only compatible with R-410A refrigerant. If any other gas enters the system, it may lead to abnormal high pressure which may cause damage or injury.
- Only use branches supplied by Haier. Use of any other branches will void warranty.
- Keep the condensate drain pipe away from toxic gas vents to prevent possible pollution of indoor environment.
- Care should be taken to ensure that there are no refrigerant leaks. R-410A is a heavy gas and will displace oxygen. Ventilate the area if a leak is found.
- The unit is not explosion-proof. Please keep it away from flammable gases.
- The drain pipe should be installed per this manual to ensure proper drainage. The pipe should be well insulated to avoid condensation. Wrong installation may lead to water damage.
- Both liquid pipe and the vapor pipe should be also well insulated. Not enough insulation may lead to system performance deterioration or condensate formation.
- This equipment should not be used or serviced by personnel who have not been properly trained in its operation and maintenance.
- Children should be supervised to ensure that they do not play on or near the equipment.
- Keep the appliance and its cord out of reach of children.
- The appliances are not intended to be operated by means of an external timer or separate remote-control system.

⚠CAUTION

- Grounding wire should be connected to the grounding bar. The grounding wire cannot be connected to the gas pipe, water pipe, lightning rod or the telephone grounding wire. Improper grounding may cause electric shock.
- A circuit breaker should be installed. If not, it may cause electric shocks or accidents.
- After installation, the air conditioning equipment should be powered on and passed the electric leakage current test.
- If the ambient humidity is more than 80%, if the water discharge hole is blocked or the filter becomes dirty or the airflow speed changes, this may lead to condensate water leaks. There may also be some drops of water spraying out.

Safety

⚠ Attention

Notices during Operation	<ul style="list-style-type: none"> Do not put any heating apparatus under the indoor units. The heat may cause distortion of the units. 	<ul style="list-style-type: none"> 3-minutes protection To protect the unit, there is a 3-minute time-out after the unit stops or after power is applied.
	<ul style="list-style-type: none"> Pay attention to the ventilation to avoid anoxic injury.  	<ul style="list-style-type: none"> Close the window to avoid outdoor air getting in. Curtains or window shutters can be put down to avoid the sunshine. 
	<ul style="list-style-type: none"> Do not place an open flame in the path of blowing air.  	<ul style="list-style-type: none"> Do not touch the power switch with the wet hand to avoid power shock. 
	<ul style="list-style-type: none"> Do not install in a corrosive environment. If the base collapses, the unit may fall and cause damage, product failure, personal injury or death. 	<ul style="list-style-type: none"> Turn off the system and remove power when servicing the unit. 
	<ul style="list-style-type: none"> Do not use the unit for special purposes such as preserving foods, works of art etc. It is an air conditioner for comfort cooling / heating, not a precision refrigeration system. 	<ul style="list-style-type: none"> Don't remove power while system is running. 
	<ul style="list-style-type: none"> Use the correctly rated breaker or fuse. Improper breaker or fuse may lead to fire, electric shock, explosion, personal injury or death. 	<ul style="list-style-type: none"> Do not clean the unit with water spray. There is risk of unit failure, fire, electric shock, personal injury or death.  
	<ul style="list-style-type: none"> Do not permit water or steam to enter the unit and the wired controller. There is risk of unit failure, fire, electric shock, personal injury or death. 	<ul style="list-style-type: none"> Keep flammable gas or combustibles away from the unit. There is risk of product failure, fire, personal injury or death. 
	<ul style="list-style-type: none"> Turn off the power to save energy if the unit will be not used for a long period. If the unit is not powered off, it will consume power. 	<ul style="list-style-type: none"> Please keep children away from this air condition equipment.

Maintenance

Cleaning the air filter & air inlet grid.

- Don't remove the air filter except for cleaning, or faults may occur.
- When the air conditioner operates in the environment with too much dust, clean the air filter on a more regular basis (generally once every two weeks).

Cleaning the Air Inlet/Outlet Grilles:

⚠ Attention

- Do not use gasoline, benzene, diluents, polishing powder or liquid insecticide to clean them.
- Do not clean them with hot water of over 122°F(50°C) to avoid fading or distorting.

- Wipe them with a soft dry cloth.
- Water or neutral dry cleaner is recommended if the dust cannot be removed.

Cleaning Air Filter:

⚠ Attention

- Don't rinse the air filter with hot water of above 122°F(50°C) to avoid fading and distorting.
- Don't put the air cleaner near fire to dry to avoid catching fire.

(A) Brush off dirt and vacuum.

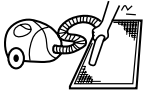

(B) Wash with soft cloth and mild detergent.

(C) Shake water off and allow the filter to fully air dry before reinstalling.



Fault Checkup

Please check the following when consigning repair service:

	Symptoms	Reasons
All these are not problems	Water flow sound	Water flow sound can be heard during starting operation, during operation or immediately after stopping operation. When it starts for 2-3 minutes, the sound may become louder, which is the flowing sound of refrigerant or the draining sound of condensate water.
	Cracking sound	During operation, the air conditioner may make a crackling sound, which is caused from the temperature changes of the heat exchanger.
	Bad smell in outlet air	Clean filters and confirm the condensate drain pan and line are clean and clear.
	Flashing operating indicator	When switching it on again after power failure, turning on the manual power switch will show the operating indicator flashes.
	Awaiting indication	It displays the waiting indication as it fails to perform refrigerating operation while other indoor units are in heating operation. When the operator set it to the cooling or heating mode and the operation is opposite to the setting, it displays the waiting indication.
	Idle indoor unit still has sound of refrigerant flowing and radiating temperatures.	To prevent oil and refrigerant from blocking the valve of idle units (off or satisfied) while other indoor units are operating, some refrigerant flow is allowed to pass through. This may result in some radiating temperature and flow noise.
	Clicking sound when unit comes on.	When the conditioner is powered on, the sound is made due to the expansion valve resetting.
	Please make another check.	Start or stop working automatically
Failure to work 		Check if there is a power failure. Check if the supply fuse and breaker are disconnected. Check if the unit is displaying any faults. Check if wait symbol is displayed. This is due to other indoor units connected to the same outdoor unit are running in the opposite mode. System cannot heat and cool simultaneously.
<ul style="list-style-type: none"> Poor cooling & heating effects 		Check if air intake port and air outlet port of outdoor units are blocked. Check if the door and windows are open. Check if the filtering screen of the air cleaner is blocked with debris or dust. Check if the fan setting is too low. Check if the mode set to Fan mode. Check if the temperature is set correctly.

Under the following circumstances, immediately stop the operation, disconnect the manual supply switch and contact the after-service personnel.

- When buttons are not flexible and actuated;
- When there are foreign objects or ice in the unit;
- When it cannot be operated after exiting the protection mode;
- When other abnormal conditions occur.

Installation Procedures

This manual cannot completely illustrate all the properties of the products you bought. Please contact the local Haier distribution center if you have any question or request.

Caution: Choose a suitable installation location.

Avoid places with high salinity (salt water) and high sulfur gas. Unit will corrode and damage will not be covered by warranty.

Avoid excess oil (including mechanical oil) and steam. This can reduce efficiencies and product performance.

Avoid areas where machines generate high frequency electromagnetic waves. They can cause control issues.

Warning:

protect the machine from winds or earthquake, install according to regulations. Improper installation will cause accidents due to unit coming loose and falling.

Indoor Units

1. The distance between air outlet and the ground should not be more than 8.8ft (2.7m).
2. Select appropriate places for installation where the airflow can be spread evenly throughout the house. Arrange proper locations for connecting pipes and lines as well as the drainpipe to the outdoor.
3. Ceiling construction must be sturdy enough to hold the weight of the unit.
4. Make sure that the connecting pipe, the drainpipe and connecting guide line can be put into walls to connect the outdoor units.
5. It is recommended to make the connecting pipe between the outdoor and indoor units and the drainpipe as short as possible.
6. Please read the attached installation instruction of the outdoor unit for refrigerant charging if necessary.
7. The connecting flange should be checked by users.
8. Electrical appliances such as television, instruments, devices, artwork, piano, wireless equipment and other valuables should not be placed under the indoor unit as to prevent condensate from dropping onto them and causing damage.

Required Tools for Installation

- Brazing torch
- 15% silver phosphorous copper brazing alloy
- Wire stripper
- Soap-and-water solution or gas leakage detector
- Torque wrench
- 17mm, 22mm, 26mm
- Tubing cutter
- Reaming tool
- Flaring tool
- Razor knife
- Measuring tape
- Level
- Vacuum pump
- Micron gauge
- Nitrogen
- Mini-Split AD-87 Adapter (1/4" to 5/16")
- Non-adhesive Tape
- Adhesive Tape
- Electrical wiring

The following steps can be taken after selecting the installation place:

1. Cut a hole in the wall and insert connection pipe and connecting wires through a field supplied PVC pipe. The hole should be inclined slightly downward with an inclination of at least 1/100 (see Figure 1).

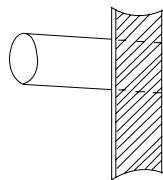

Figure 1

2. Before cutting the hole, ensure no pipe or rebar is placed behind the cutting position. Avoid cutting a hole near wires or connection pipes.
3. Hang the unit on a horizontal and firm roof. If the unit base is not stable, it may cause noise, vibration or leakage.
4. Support the unit firmly and shape the connection pipe, connecting wires and drain pipe to allow them to easily get through the hole.

Installation Procedures

Dimension (unit: in.).

Model	a	b	c	d	e	f	g	h	i
MVAD007~12MV2AA	16.5	35.1	14.6	33.5	7.3	25.2	3.6	29.9	6.0
MVAD018~24MV2AA	16.5	47.7	14.6	46.1	7.3	37.8	3.6	42.5	6.0

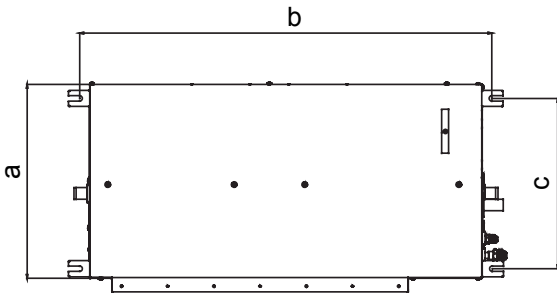

Hanger dimensions

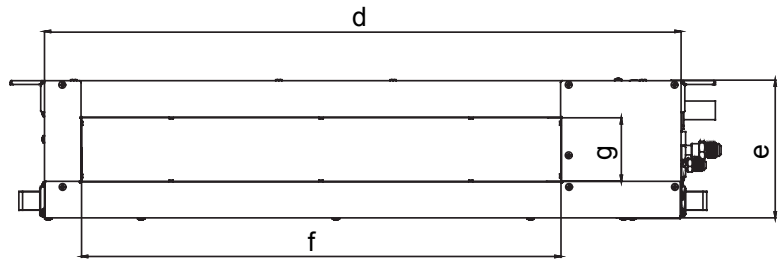

Dimensions of air outlet

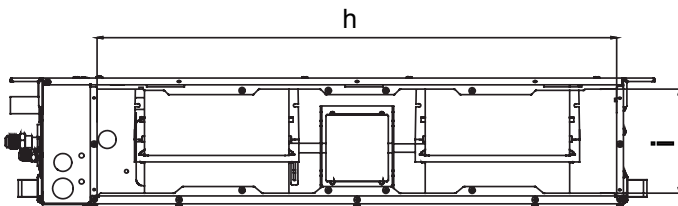

Dimensions of return air inlet

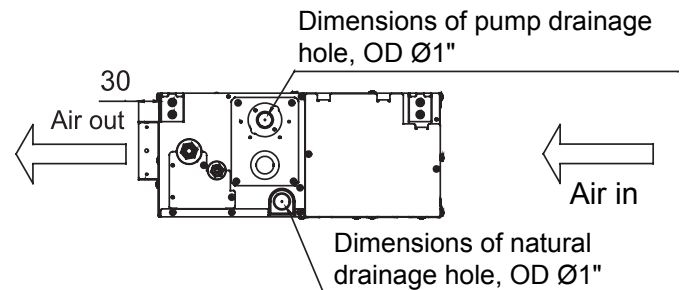

Dimensions of drain hose

Installation modes of Indoor unit

This series of air conditioners can be arranged in two air return modes: 1. Air return from the back (Factory default); 2. Air return from the bottom (can be adjusted on site. See the following figures.)

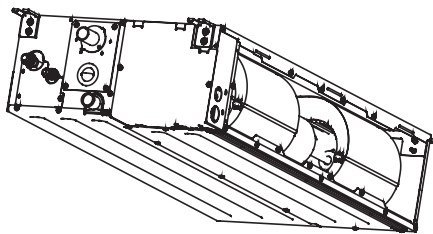

Air return from the back

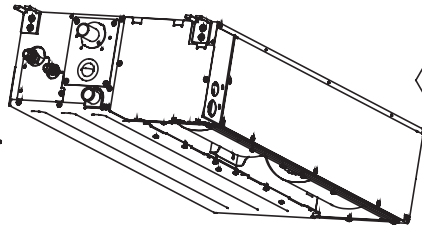

Air return from the bottom 1

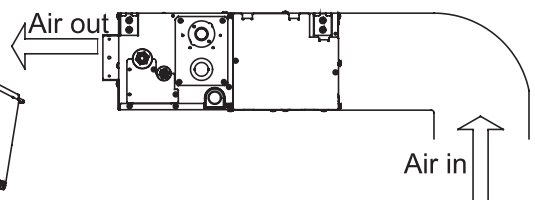

Air return from the bottom 2

Note:
The downward air return mode will increase noise 3-5dB(A). It is recommended to install the air conditioner in downward return air mode 2 if enough space is available.

Installation space and method

Body installation

1. Use 3/8" (M10) lifting bolts.
2. Ceiling removal: For different building structures, please consult with building personnel about actual conditions.
 - a. Ceiling reinforcement: Ensure the ceiling is horizontal and will not shake. The ceiling base frame must be reinforced.
 - b. Cut off and remove the ceiling base frame.
 - c. Reinforce the faces left when the ceiling is removed and further reinforce the base frame that fix both ends of the ceiling.
 - d. After the unit installation is complete, it is time to install pipes and wires. Before installation, choose a suitable installation position and determine the outgoing direction of pipes. Especially in case that a ceiling exists, please pull refrigerant tubing, drain hose, indoor and outdoor connecting wires, control wires to their connection positions prior to hanging the machine.

Installation Procedures

Installation space

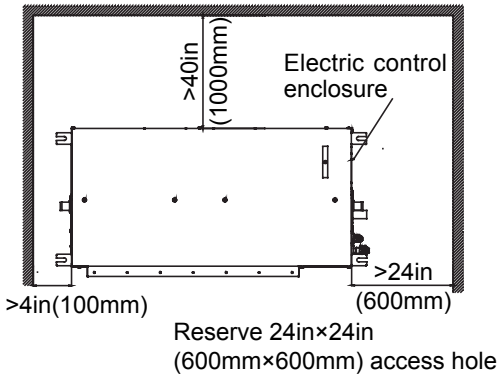

Installation mode

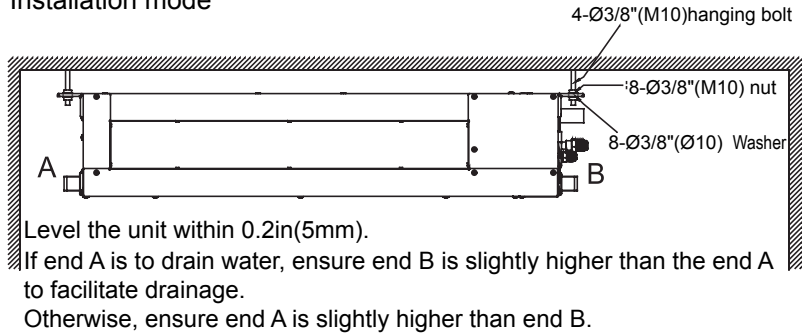

Installation of air-inlet grille

The angle of air-inlet grille should be parallel with that of air inlet direction, otherwise it will cause more noise. Example shown to the right.

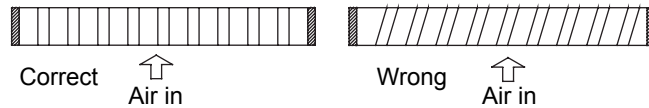

Duct Installation of Indoor Units:

1.Installation of the duct work:

With a square supply duct, the bore shouldn't be less than the sizes of air outlet duct.

2.Installation of the air return duct: Connect one side of the air return duct to the air return of the indoor units with rivets, with the other side connected to air return shutter, as shown in Fig. 1.

3.Insulating Supply Ducts: Supply and return air ducts should be insulated.

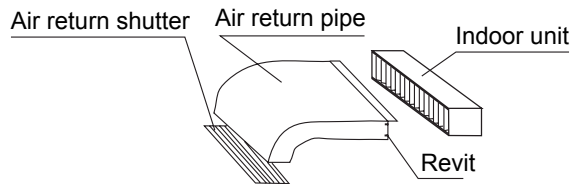

Fig.1

Connection of oil return pipe

Selection of fan outlet

This machine uses a DC motor. Multiple ESP adjustments are available. The factory default is standard ESP. The ESP & Silent mode can be set according to the static pressure and the noise requirement. Setting ranges are as follows:

Model	Ultra-Silent	Silent	Standard ESP default	High ESP	Super High ESP
Grade	1	2	3	4	5

Operation:

YR-E17 wired controller: With the display on, press Fan + Set keys for 5s to enter static pressure set mode. The static pressure icon will flash and current static pressure will display. Press ▼▲ key to change static pressure grade, then press the Set key to confirm.

Note:

This series are low ESP duct, all the sets above must be handled by a wired controller.

Installation Procedures

Installation of drain hose

Connection of indoor drain hose

1. Please use the accessory drain hose to connect indoor unit's water outlet and PVC pipe. Use snap rings to tighten them as shown in the following figure:
2. Please use rigid PVC adhesive for connection of other pipes and ensure there is no leakage.
3. Drain hose must be wrapped with insulation sleeve and tightened with a strap to prevent air leakage from producing condensate.
4. To prevent water flowing back into air conditioner when the unit stops running, drain hose should decline to the drainage side with an inclination of above 1/100. Drain hose expansion or water accumulation should be prevented, or else it will cause abnormal noise.
5. When connecting the drain hose, do not pull on it to avoid the pipe connections from getting loose or disconnected. Drain hose should not be pulled out laterally for more than 8in(200mm) and should be supported every 31-39in(0.8-1.0m) to avoid bending.
6. The end of drain hose should be more than 2in(50mm) away from the ground or the bottom of drainage tank. It should not be put in water. To directly drain condensate into drainage ditch, the drain hose must be U-shaped to avoid smell from entering through the hose into room.

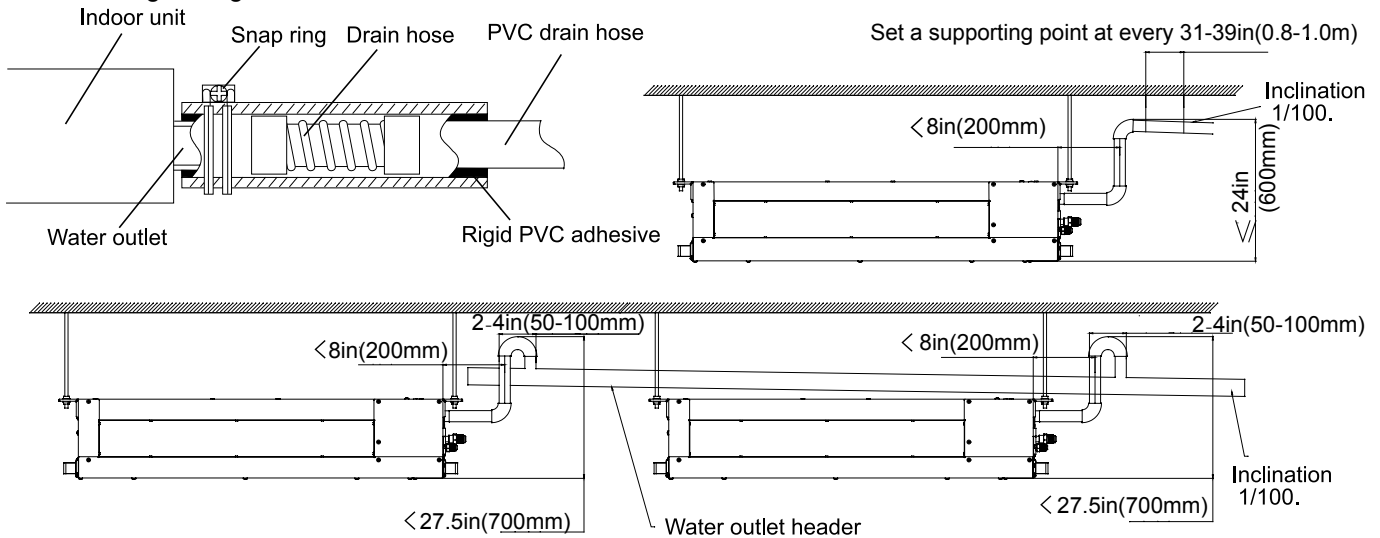

Multiple units use water outlet header to drain water into drainage ditch.

Drainage test

Before the test, ensure the drain hose is clear and all connections are tightly sealed.

Then perform the drainage test as follows:

1. Add about 0.132gal (500ml) of water into the water pan through water injection hole.
2. Switch on the power and operate the unit in cooling mode. Check that the water outlet drains water normally and that there are no leakages at the connections. After the drainage test is complete, replace the water injection hole plug. For the position of water injection hole, see the figure on the right:

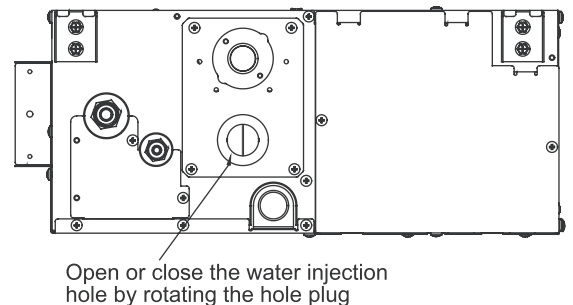

Open or close the water injection hole by rotating the hole plug

Installation Procedures

Pipe Length & Height Difference

Please refer to the attached manual of outdoor units.

Model		MVAD007~018MV2AA	MVAD024MV2AA
Tubing Size in(mm)	Gas pipe	Ø1/2"(Ø12.7)	Ø5/8"(Ø15.88)
	Liquid pipe	Ø1/4"(Ø6.35)	Ø3/8"(Ø9.52)
Tubing Material		Seamless copper pipe rated for R410A refrigerant	

Tubing Materials & Specifications

Special tools for R410A should be used for cutting and enlarging pipes.

Refrigerant Recharge Amount

Add the refrigerant according to the installation instruction of outdoor unit. The addition of R410A refrigerant must be performed with a digital scale to ensure the proper charge. Compressor failure can be caused by over or under charging the system.

Connecting Procedures of Refrigerant Tubing

Connect all the refrigerant tubes via flare connections.

- Dual wrenches must be used in the connection of indoor unit tubing.
- For tightening torque refer to the right table.

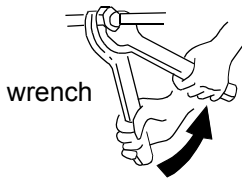

Outer Diameter of Tubing in(mm)	Mounting Torque lb-in(N-m)	Flare Torque Spec ft-lb (N-m)
Ø1/4"(Ø6.35)	104.4(11.8)	13 (18)
Ø3/8"(Ø9.52)	216.8(24.5)	30 (40)
Ø1/2"(Ø12.7)	443.7(49.0)	43 (59)

Cutting and Enlarging

- Cut the tube to the needed length.
- Ream the cut to remove shoulder. Do this with the tube facing down to help fillings fall out.
- Add supplied flare nut to tube.
- Use 45° flare tool to create flare.

Wire Connections

1. Connecting using circular crimp terminals:

The method of using circular terminal is shown in the figure. Take off the screw, connect it to the terminal after placing it through the ring at the end of the lead and tighten it down.

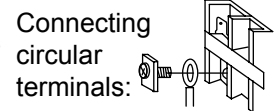

2. Connecting using straight terminals:

The method of using straight terminals is shown as follows: loosen the screw before putting the wire into the terminal block, tighten the screw and confirm it has been tightened by pulling the line gently.

3. Clamp the wires:

Secure the wires with clips which should press on the insulation of the wires.

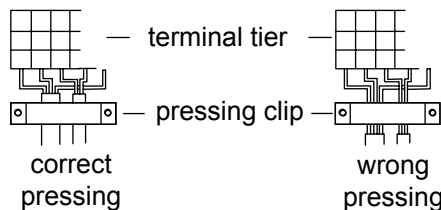

Electrical Wiring

⚠ WARNING

- Follow local codes when selecting wire gauge and connecting to house power.
- Use the cable strain relief clips and locking conduit clamps to prevent wires from being pulled off terminal posts.
- Unit must be properly grounded. Do not use water or gas piping, phone ground or lightning rod.

⚠ Attention

- Only copper wire can be used. A properly sized breaker should be provided, or electric shock may occur.
- Unit requires 220VAC - 2 voltage wires and a ground. No neutral.
- All indoor units should be wired to the same breaker to prevent some of the units from being powered off while others are energized.
- Controller wiring and refrigerant tubing can be arranged and ran together.
- Disconnect power from both outdoor and indoor units prior to servicing any component in the system.

Supply Wiring Drawing

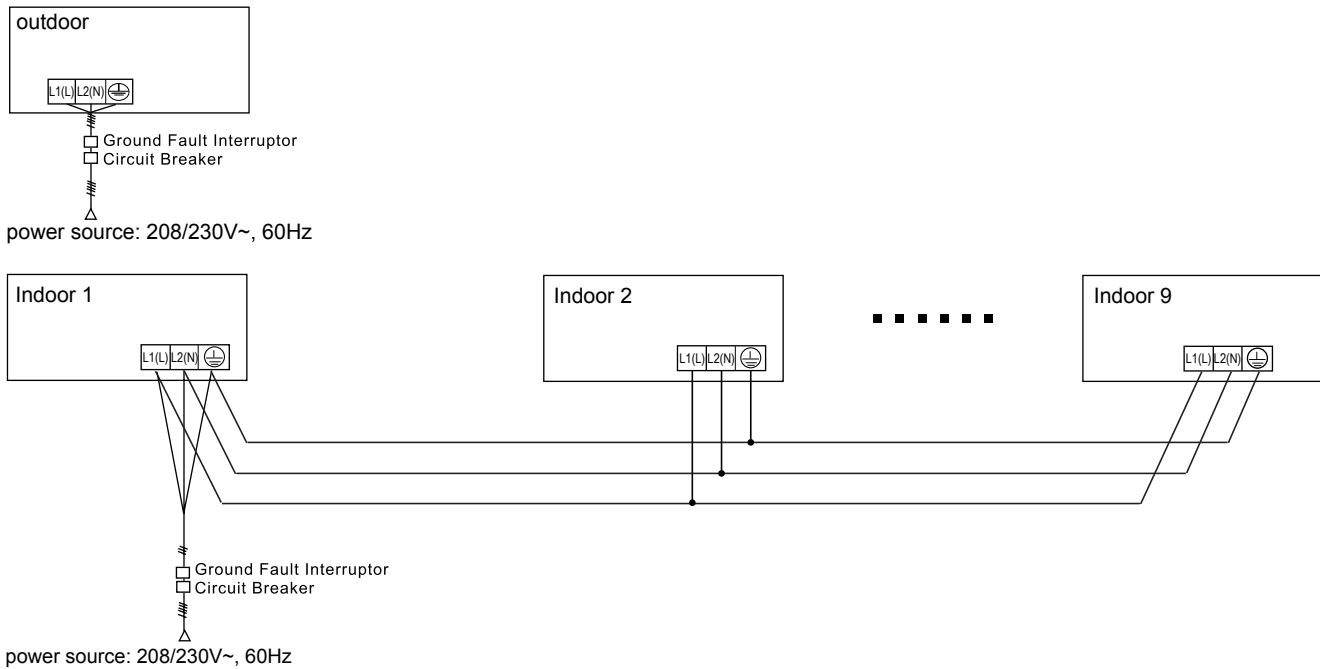

- Indoor units and outdoor units should be connected to separate power breakers.
- Indoor units must share one single electrical breaker. Circuit breaker specifications should be calculated. It is recommended to have both indoor & outdoor units connected to GFCI and surge devices.

Electrical Wiring

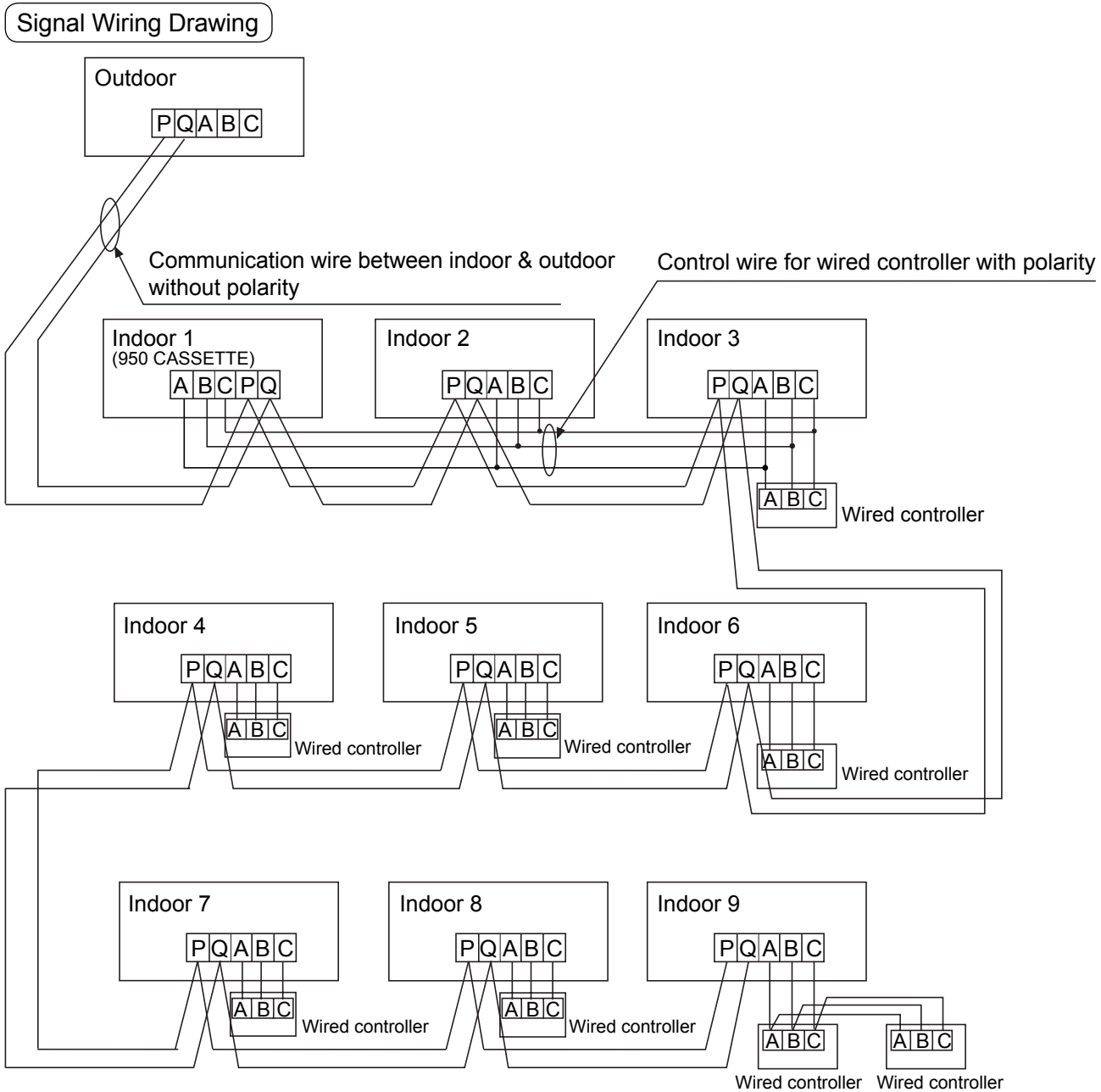

Outdoor units are of parallel connection via three lines with polarity. The main unit, central control and all indoor units are of parallel connection via two lines without polarity.

There are three ways of connecting the line control and indoor units:

- One wired control to control multiple units, i.e. 2-9 indoor units, as shown in the above figure, (1-3 indoor units). The indoor unit 3 is the wire controlled main unit and others are the wired controlled sub units. The remote control and the main unit (directly connected to the indoor unit of wired control) are connected via three wires with polarity. Other indoor units and the main unit are connected via three lines with polarity. SW01 on the main unit of wired control is set to 0 while SW01 on other sub units of wired control are set to 1, 2 and so on in turn. (Please refer to the code setting A at page 14)
- One wired control controls one indoor unit, as shown in the above figure (indoor unit 4-8). The indoor units and the wired control are connected via three lines with polarity.
- Two wired controls control one indoor unit, as shown in the figure (indoor unit 9). Either of the wired controls can be set to be the master wired control while the other is set to be the auxiliary wired control. The master wired control and indoor units, and the master and auxiliary line controls are connected via three lines with polarity.

Note: For DC motor/low ESP duct type, the PCB comes with the terminal blocks. Please be sure to pay attention to do the wiring according to the labels. The power lines and signal lines go through the metal wire hole separately with the protective sleeve of the connecting line.

Electrical Wiring

Wire gauge size and breaker size for total indoor amp draw. Current NEC guidelines and local codes will trump this chart.

Items Total Current of Indoor Units(A)	Cross Section AWG (mm ²)	Length in.(m)	Rated Current of Overflow Breaker(A)	Rated current of residual Circuit Breaker(A) Ground Fault Interrupter(mA) Response time(S)	Cross Sectional Area of Signal Line
<7	14(2.5)	65.6(20)	10	10 A,30 mA,0.1S or below	16 AWG (1.25mm ²)
≥7 and <11	12(4)	65.6(20)	15	15 A,30 mA,0.1S or below	
≥11and <16	10(6)	82(25)	20	20 A,30 mA,0.1S or below	
≥16 and <22	8(8)	98.4(30)	30	30 A,30 mA,0.1S or below	
≥22 and <27	6(10)	131(40)	30	30 A,30 mA,0.1S or below	

- The electrical power line and signal lines must be tightened.
- Every indoor unit must have a ground connection.
- The power wire should be size up if it exceeds the permissible length.
- Shielding of the wire of all the indoor and outdoor units should be connected together and grounded at one point.
- Signal lines should not exceed 3280ft(1000m).

Wired Controller ABC Chart

Length of Controller Wire ft (m)	Wiring Dimensions AWG (mm ²)
<328(100)	22(0.3) x 3 core shielding line
≥328(100) and <656(200)	20(0.5) x 3 core shielding line
≥656(200)and <984(300)	18(0.75) x 3 core shielding line
≥984(300) and <1312(400)	16(1.25) x 3 core shielding line
≥1312(400) and <1968(600)	14(2) x 3 core shielding line

- The shielding lay of the controller wire must be grounded at one end.
- The total length of the controller wire shall not be more than 1968ft(600m).

Electrical Wiring

Dipswitch Setting

- The dip switch is set to the "On" position if "1" is indicated in the table. The dip switch is set to the "Off" position if "0" is indicated in the table.
- Dip switches set in the factory to on are marked with red.

Definition principles of code switches:

(A) Definition of SW01:

SW01_1-4 is used to set indoor address when grouping multiple indoor units connected to single wired controller YR-E16B or YR-E17.

SW01_5-8 set capacity of the indoor unit (factory set). Must only set when replacing board.

SW01_1 SW01_2 SW01_3 SW01_4	Address of wire controlled indoor unit (group address)	[1]	[2]	[3]	[4]	Address of wire controlled indoor unit (group address)
		0	0	0	0	0# (wire controlled master unit) (default)
		0	0	0	1	1# (wire controlled slave unit)
		0	0	1	1	2# (wire controlled slave unit)
		0	0	1	1	3# (wire controlled slave unit)
	
SW01_5 SW01_6 SW01_7 SW01_8	Capability of indoor unit	[5]	[6]	[7]	[8]	Capability of indoor unit
		0	0	0	0	5000BTU(0.6HP)
		0	0	0	1	7000BTU(0.8HP)
		0	0	1	0	9000BTU(1.0HP)
		0	0	1	1	11000BTU(1.2HP)
		0	1	0	0	12000BTU(1.5HP)
		0	1	0	1	15000BTU(1.7HP)
		0	1	1	0	18000BTU(2.0HP)
		0	1	1	1	22000BTU(2.5HP)
		1	0	0	0	27000BTU(3.0HP)
		1	0	0	1	28000BTU(3.2HP)
		1	0	1	0	36000BTU(4.0HP)
		1	0	1	1	45000BTU(5.0HP)
		1	1	0	0	54000BTU(6.0HP)
		1	1	0	1	72000BTU(8.0HP)
1	1	1	0	90000BTU(10.0HP)		
1	1	1	1	135000BTU(15.0HP)		

Note : A wired controller can connected to at most sixteen ultrathin air-duct indoor units.

Electrical Wiring

(B) Definition and description of SW03

SW03_1-8 is used to set indoor unit address on system. Set address only if using central controller YCZ-A004. Leave default if no central controller is used.

SW03_1	Address setting mode	0	Automatic address setting or wired controller address setting (default)								
		1	Code-set address								
SW03_2 ~ SW03_8	Code-set indoor unit address and centralized controller address	2	3	4	5	6	7	8	Address of indoor unit	Address of centralized controller	
		0	0	0	0	0	0	0	0	0# (Default)	0# (Default)
		0	0	0	0	0	0	0	1	1#	1#
		0	0	0	0	0	0	1	0	2#	2#
	
		0	1	1	1	1	1	1	1	63#	63#
		1	0	0	0	0	0	0	0	0#	64#
		1	0	0	0	0	0	0	1	1#	65#
		1	0	0	0	0	0	1	0	2#	66#
	
		1	1	1	1	1	1	1	1	63#	127#

Note:

- Set the address by code when connecting the centralized controller, gateway or control system.
- Address of centralized controller = communication address + 0 or +64.
 SW03_2=OFF, address of centralized controller = communication address + 0 = communication address
 SW03_2=ON, address of centralized controller = communication address + 64 (applies when centralized controller is used and there are more than 64 indoor units)



Electrical Wiring

Dip Switch Setting of YR-E17 Wired Controller

Function switches

DIP switch	On/Off station	Function	Default setting
Sw1	On	Slave wired controller	Off
	Off	Master wired controller	
Sw2	On	Ambient temp. display on	Off
	Off	Ambient temp. display off	
Sw3	On	Collect ambient temp. from PCB of indoor	Off
	Off	Collect ambient Temp. from wired controller	
Sw4	On	Non-volatile memory invalid	Off
	Off	Non-volatile memory valid	
Sw5	On	Old protocol	Off
	Off	Self adaption	
Sw6	On	reserved	Off
	Off	reserved	
Sw7	On	Model with Up/Down and Left/Right swing	Off
	Off	Model with Up/Down swing	
Sw8	On	Fresh Air unit	Off
	Off	General unit	

For other wired remote controller settings, please refer to controller manual.

The difference between master and slave wired controller

Comparison item	Master wired controller	Slave wired controller
Function	All function	1.ON/OFF, Mode, Fan speed, Temp, Setting, Swing, Energy saving, Clock function, Mode Setting, Screen Saving and Child lock are available. 2.Cancel the filter cleaning icon. 3.Look up the detailed parameter and malfunction code.

Test Run & Failure Code

Before Test Run

- Connect it to the power supply of the outdoor units to energize the heating belt of the compressor. To protect the compressor at startup, power it on 12 hours prior to the operation.

Check if the connections of the drainpipe and wire connection lines are correct.

The drainpipe shall be placed at the lower part while the connection line placed at the upper part. Insulating measures should be taken such as winding the drainpipe especially on the indoor units with insulating materials.

The drain pipe should be installed as a slope to avoid protruding from the upper part and concaving at the lower part.

Checkup of Installation

- Check if the mains voltage is matching
- Check for any leaks at the piping joints
- Check if the connection of the main power for the indoor & outdoor units are correct
- Check if the serial numbers of the terminals are matched properly
- Check if the installation place meets the requirement
- Check if there is too much noise
- Check if the connecting line is fastened
- Check if the refrigerant and condensation lines are insulated
- Check if the water is drained to the outside
- Check if the indoor units are positioned

Test Run

Ask the installation technician to perform a test run. Compare the testing procedures according to the manual and check if the temperature control works properly.

When the machine fails to start because of the room temperature, the following procedure can be used to force compulsive running mode. The function is not available for the type with remote control.

- Set the YR-E17 wired controller to cooling/heating mode, press "ON/OFF" button for 10 seconds to enter into the compulsive cooling/heating mode. Press "ON/OFF" button again to quit the compulsive running and stop the operation of the system.

Fault Remedies

When any fault appears, refer to "Inquiry of fault records of indoor units" at the previous page, consult the fault code of line control or the number of LED flashes on the control panel of the indoor units/health lamp of receiving window of remote control. Refer to the below table lookup fault descriptions.

Indoor Unit Faults

Failure code at wired controller	PCB LED5(Indoor Units)/ Receiver Timer Lamp (Remote Controller)	Fault Descriptions
01	1	Fault of indoor unit ambient temp. sensor TA
02	2	Fault of indoor unit pipe temp. sensor TC1
03	3	Fault of indoor unit pipe temp. sensor TC2
04	4	Fault of indoor unit dual heat source temp. sensor
05	5	Fault of indoor unit EEPROM
06	6	Fault of communication between indoor & outdoor units
07	7	Fault of communication between indoor unit and wired control
08	8	Fault of indoor unit float switch
09	9	Fault of duplicate indoor unit address
12	12	Fault of indoor unit 50Hz Zero-crossing
14	14	Fault of indoor unit DC motor
18	18	BS valve box or 4WV switch failure
20	20	Corresponding faults of outdoor units

Qingdao Haier Air Conditioner Electric Co.,Ltd.

Haier Industrial Park,Qianwangang Road,Eco-Tech Development Zone,Qingdao 266555,
Shandong,P.R.C.