



**BOSCH**



**Register** your  
new device on  
MyBosch now and  
get free benefits:  
**[bosch-home.com/  
welcome](https://bosch-home.com/welcome)**

# Washing machine

**WAT...**

**en** Instruction Manual and Installation Instructions

## Your new washing machine

You have chosen a Bosch washing machine.

Please take a few minutes to read and become familiar with the advantages of your washing machine.

To meet the high quality demands required by Bosch, every washing machine that leaves our factory is carefully checked to ensure that it functions correctly and is in perfect condition.

For more information on our products, accessories, replacement parts and services, see our website [www.bosch-home.com](http://www.bosch-home.com) or contact our after-sales service centres.

If the operating and installation instructions describe different models, any differences will be pointed out at the relevant points in the text.



Read these operating and installation instructions before switching on the washing machine.

## Display rules

### **Warning!**

This combination of symbol and signal word indicates a possibly dangerous situation. Not heeding the warning can cause death or injuries.

### **Caution!**

This signal word indicates a possibly dangerous situation. Not heeding the caution can cause property and/or environmental damage.

### **Note/tip**

Information about the optimum use of the appliance/any other useful information.













### **1. 2. 3. / a) b) c)**



The steps are represented by numbers or letters.

■ / -

Lists are represented by a small box or a dash.

# Contents

 <b>Intended use</b> .....	4	Change the programme default settings .....	16
 <b>Safety instructions</b> .....	5	Select additional programme settings	16
Electrical safety .....	5	Placing laundry into the drum .....	16
Risk of injury .....	5	Measure and add detergent and care products .....	17
Safety for children .....	5	Start the programme .....	18
 <b>Environmental protection</b> .....	6	Childlock .....	18
Packaging/used appliance .....	6	Adding laundry .....	18
Tips on economical use .....	6	Changing the programme .....	19
 <b>Familiarising yourself with your appliance</b> .....	8	Cancel the programme .....	19
Washing machine .....	8	Programme end during rinse hold ..	19
Control panel .....	8	Programme end .....	19
Display panel .....	10	Removing laundry/switching off the appliance .....	19
 <b>Laundry</b> .....	11	 <b>Sensors</b> .....	20
Prepare the laundry .....	11	Automatic load sensing .....	20
Sorting laundry .....	11	Unbalanced load detection system ..	20
Starching .....	11	VoltCheck .....	20
Dyeing/bleaching .....	12	 <b>Setting the signal</b> .....	20
Soaking .....	12	 <b>Cleaning and maintenance</b> .....	21
 <b>Detergent</b> .....	12	Machine housing/control panel .....	21
Correct selection of detergent .....	12	Drum .....	21
Saving energy and detergent .....	13	Descaling .....	21
 <b>Programme default settings</b> .....	13	Detergent drawer and housing .....	21
Temperature .....	13	Detergent solution pump blocked ..	22
Spin speed .....	13	The drain hose at the siphon is blocked .....	22
Finished in-time .....	14	Filter in the water supply blocked ..	23
 <b>Additional programme settings</b>	15	 <b>Faults and what to do about them.</b>	24
Speed Eco .....	15	.....	24
Easy-Iron .....	15	Emergency release .....	24
Water&Rinse+ .....	15	Information on the display panel ..	24
Prewash .....	15	Faults and what to do about them. .	25
 <b>Operating the appliance</b> .....	16		
Preparing the washing machine .....	16		
Select programme/switch on the appliance .....	16		

	After-sales service . . . . .	27
	Technical data . . . . .	28
	Positioning and connecting. . . . .	28
	Included with the appliance . . . . .	28
	Safety instructions . . . . .	29
	Installation surface . . . . .	29
	Installation on a base or a wooden joist floor . . . . .	29
	Installation on a platform with drawer . . . . .	30
	Installing the appliance in a kitchenette . . . . .	30
	Removing the transport locks . . . . .	30
	Hose and cable lengths . . . . .	31
	Water inlet . . . . .	31
	Water outlet . . . . .	33
	Levelling . . . . .	33
	Electrical connection . . . . .	34
	Before washing for the first time . . . . .	34
	Transportation . . . . .	35

---

## Intended use

- For private domestic use only.
- The washing machine is suitable for washing machine-washable fabrics and hand-washable wool in water containing detergent.
- To be operated with cold\* mains water or cold and hot\* mains water (max. 60 °C), and standard detergents and care products which are suitable for use in washing machines.
- When measuring out the amount of all detergents, additives, care products and cleaning agents, always follow the manufacturer's instructions.
- The washing machine may be used by children over the age of 8 years and by persons with reduced physical, sensory or mental capacity or by persons with a lack of experience or knowledge if they **are supervised** or have been **instructed** by a responsible person. Children must not carry out any cleaning or maintenance work without supervision.
- This appliance is intended for use up to a maximum height of 4000 metres above sea level.
- Keep children under the age of 3 years away from the washing machine.
- Keep pets away from the washing machine.

Read the Instruction Manual and Installation Instructions and all other information supplied with the washing machine and use the machine accordingly.

Retain the documents for subsequent use.

\* depending on the model

## Safety instructions

### Electrical safety

#### Warning

#### **Danger of death!**

There is a risk of electric shock if you touch live components.

- Never touch or hold the mains plug with wet hands.
- Only pull out the mains cable by the plug and never by the cable, as this could damage it.

### Risk of injury

#### Warning

#### **Risk of injury!**

- When the washing machine is lifted by its protruding parts (e.g. the washing machine door), the components may break off and cause injuries. Do not lift the washing machine by protruding parts.
- If you climb on the washing machine, the worktop may break and cause injuries. Do not climb onto the washing machine.
- If you lean on the washing machine door when it is open, the washing machine may tip over and cause injuries. Do not lean on the washing machine door when it is open.

- Reaching into the drum when it is turning can cause injuries to hands. Do not reach into the drum when it is turning. Wait until the drum has stopped turning.

#### Warning

#### **Risk of scalding!**

When you are washing at high temperatures, there is a risk of scalding if you come into contact with hot water e.g. if hot water is being drained into a wash basin.

Do not reach into the hot detergent solution.

### Safety for children

#### Warning

#### **Danger of death!**

If children play with the washing machine, they may get into life-threatening situations or injure themselves.

- Do not leave children unattended near the washing machine.
- Do not let children play with the washing machine.

#### Warning

#### **Danger of death!**

Children may lock themselves in appliances, putting their lives at risk.

For appliances that have reached the end of their service life:

- Disconnect the mains plug.

- Cut through the mains cable and remove it, along with plug.
- Destroy the lock on the washing machine door.

 **Warning**  
**Risk of suffocation!**

Children may become wrapped in packaging/film or packing parts if allowed to play with them, or they may pull them over their heads and suffocate.

Keep packaging, film and packaging parts out of the reach of children.

 **Warning**  
**Risk of poisoning!**

Detergents and care products may be poisonous if consumed.

Keep detergents and care products out of the reach of children.

 **Warning**  
**Eye/skin irritation!**

Detergents and care products may cause irritation if they come into contact with the eyes or skin.

Keep detergents and care products out of the reach of children.

 **Warning**  
**Risk of injury!**

When you wash at high temperatures, the glass in the washing machine door gets hot.

Do not let children touch the hot washing machine door.

---

 **Environmental protection**

**Packaging/used appliance**



Dispose of packaging in an environmentally-responsible manner.

This appliance is labelled in accordance with European Directive 2012/19/EU concerning used electrical and electronic appliances (waste electrical and electronic equipment - WEEE).

The guideline determines the framework for the return and recycling of used appliances as applicable throughout the EU.

**Tips on economical use**

- Always fill the appliance with the maximum amount of laundry for each programme.  
Overview of programmes →: Supplementary sheet for the operating and installation instructions.
- Wash normally soiled laundry without a prewash.
- Save energy and detergent when washing lightly and normally soiled laundry. → *Page 13*

- The selectable temperatures apply to the care labels on the textiles. The temperatures in the machine may deviate from this so that you get the optimum mix of energy-saving and washing results.
- **Information about the energy consumption\*:** → *Page 10*  
The display provides information about the relative energy consumption in the selected programs.  
The more indicator lights light up, the higher the program's consumption.  
This enables you to compare the consumption levels of the different programs when choosing your program settings and to decide on an energy- and water-saving program setting.  
\*depending on the model
- **Energy-saving mode:** The display panel lighting goes out after a few minutes and the  button flashes. Press any button to activate the lighting.  
Energy-saving mode is not activated if a programme is running.
- If the laundry is subsequently dried in a tumble dryer, select the spin speed according to the tumble dryer manufacturer's instructions.

## Familiarising yourself with your appliance

### Washing machine

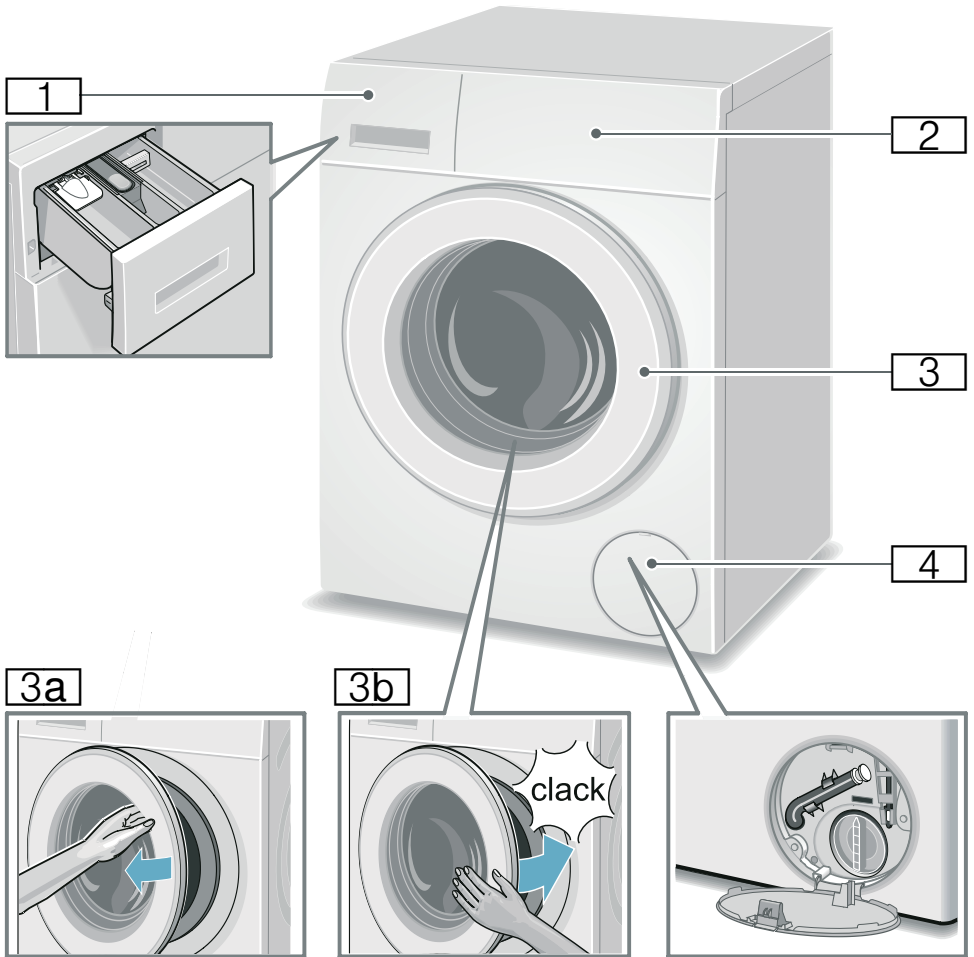

- 1** Detergent drawer → *Page 17*
- 2** Operating/display panel
- 3** Door with door handle

- 3a** Open the door
- 3b** Close the door
- 4** Service flap

### Control panel

Control panel depends on the model

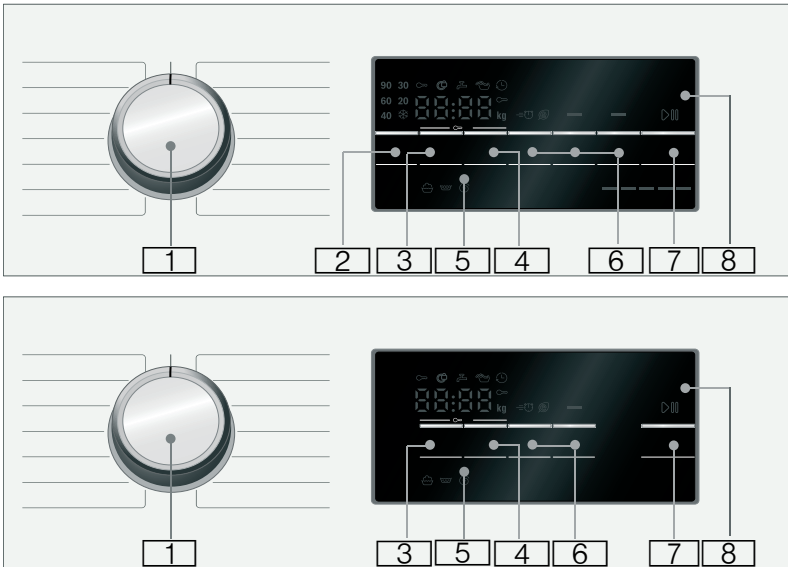

### 1 Program selector

for selecting a program and switching the machine on and off via the **Off** position; You can find an overview of all programs on the supplementary sheet for the installation and operating instructions.

### 2 Change **Temperature** \*.

→ Page 13

### 3 Change **Spin speed**. → Page 13

### 4 Change **Finished in-time**.

→ Page 14

### 5 **Childlock** (∞ 3 sec., ∞ 3 δευτ.)

to prevent the set functions from being changed accidentally;

→ Page 18

To do so, press **Spin speed** and **Finished in-time** simultaneously for approx. **3 seconds**.

### 6 **Select additional program settings if necessary:** → Page 15

- Speed Eco
- Water&Rinse+ \*
- Easy-Iron \*
- Prewash \*

### 7 ▷ button for:

- Starting a program
- Interrupting a program, e.g. to add items of laundry  
→ Page 18
- Cancelling a program  
→ Page 19

### 8 **Display panel** for settings and information → Page 10

\*depending on the model

## Display panel



**Note:** You will find settings and information for the selected program in the table.

☼ - 90 °C      **Temperature\*** in °C;  
☼ = cold

----, 0 - 1400\*\* Ⓢ **Spin speed** in rpm,  
0 = no spin cycle,  
draining only  
→ *Page 13*,  
= Rinse Stop  
→ *Page 13*

e.g. 2:30;      **Finished in-time**  
Program duration  
depends on the  
program selection in  
h:min  
(hours:minutes),

1 - 24 Ⓢ **End time  
preselection** in  
hours;  
End of program after  
... hours

9\*\* kg      **Load  
recommendation**

⚡ = = = = = **Energy  
consumption  
display** → *Page 7*  
The more indicator  
lights light up, the  
higher the relative  
energy  
consumption.

\*depending on the model

\*\* depending on the selected program,  
settings and model

### More information on the display panel

#### Program progress:

	Washing
	Rinse
	Spin
End	Program end
---- Ⓢ	Program end during Rinse Stop

#### Washing machine door:

 lights up	The washing machine door cannot be opened.
 flashes	When the program has started: The washing machine door is not closed properly.

#### Tap:

 flashes	Tap not turned on, no water pressure
 lights up	Water pressure too low (may increase the program duration)

#### Childproof lock: → *Page 18*

 lights up	Childproof lock activated
 flashes	Childproof lock activated, program selector adjusted

#### Foam detection:

 lights up	→ <i>Page 18</i>
---------------	------------------

#### Fault display:

E: --	→ <i>Page 24</i>
-------	------------------

#### Signal setting:

0 - 4	→ <i>Page 20</i>
-------	------------------

## Laundry

### Prepare the laundry

#### Caution!

#### Damage to the appliance/fabrics

Foreign objects (e.g. coins, paperclips, needles, nails) may damage the laundry or components in the washing machine.

You should therefore note the following tips when preparing your laundry:

- Empty any pockets.

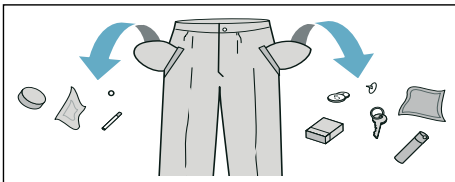

- Look out for metal items (paperclips, etc.) and remove them.
- Wash delicates in a laundry bag (tights, underwired bras, etc.).
- Close any zips; button up any cover buttons.
- Brush sand out of pockets and collars.
- Remove curtain fittings or place curtains in a laundry bag.

### Sorting laundry

Sort your laundry according to the care instructions and manufacturer's information on the care labels, depending on:







- Type of fabric/fibre
- Colour
  - Note:** Laundry can discolour or not be cleaned correctly. Wash white and coloured items separately. Wash new coloured items separately the first time you wash them.
- Soiling
  - Wash laundry with the same level of soiling together.

Some examples of soiling levels can be found on → *Page 13*.

- **Light:** Do not prewash, select the **Speed** setting if necessary
- **Normal**
- **Heavy:** Load less laundry, select a program with prewash
- **Stains:** Remove/pretreat stains while they are fresh. Firstly, dab with soapy water; do not rub. Then wash the items of laundry with the appropriate program. Stubborn or dried-in stains can sometimes only be removed by washing several times.

- Symbols on the care labels

**Note:** The numbers in the symbols indicate the maximum washing temperature that may be used.

-  Suitable for normal washing process; e.g. Cottons program
-  A gentle washing process is required; e.g. Easy-Care program
-  An especially gentle washing process is required; e.g. Delicate/Silk program
-  Suitable for washing by hand; e.g.  Wool program
-  Do not machine wash.

### Starching

**Note:** Laundry should not be treated with fabric softener.

Liquid starch can be used to stiffen fabrics particularly in the Rinse and Cottons programmes. Measure starch into compartment  in accordance with the manufacturer's instructions (clean first if necessary).

## Dyeing/bleaching

Dye should only be used in normal household quantities. Salt may damage stainless steel. Always follow the dye manufacturer's instructions.

Do **not** use the washing machine to bleach clothes.

## Soaking

1. Switch on the appliance.
2. Select the  **Cottons 20 °C** program.
3. Pour soaking agent/detergent into compartment **II** in accordance with the manufacturer's instructions.
4. Press the  button.
5. After approx. 10 minutes, press the  button to pause the program.
6. Leave the laundry to soak for as long as required, then either press the  button again to continue the program or change the program.

## Notes

- Load laundry of the same colour.
- No additional detergent is required; the soaking solution is used for washing.

## Detergent

### Correct selection of detergent

The care label is crucial for selecting the correct detergent, temperature and treatment of the laundry. → See also [www.sartex.ch](http://www.sartex.ch)

If you visit [www.cleanright.eu](http://www.cleanright.eu), you will find further information on detergents, care products and cleaning agents for domestic use.

- **Standard detergent with optical brighteners**  
Suitable for boil-washable white laundry made from linen or cotton  
Programme: Cottons/  
cold - max. 90 °C
- **Detergent for colours without bleach or optical brighteners**  
Suitable for coloured laundry made from linen or cotton  
Programme: Cottons/  
cold - max. 60 °C
- **Detergent for colours/delicates without optical brighteners**  
Suitable for coloured laundry made from easy-care fibres, synthetic fibres  
Programme: Easy-Care/  
cold - max. 60 °C
- **Detergent for delicates**  
Suitable for delicate, fine fabrics, silk or viscose  
Programme: Delicate/Silk/  
cold - max. 40 °C
- **Detergent for woollens**  
Suitable for wool  
Wool programme/  
cold - max. 40 °C

## Saving energy and detergent

For light and normal soiling, you can save energy (lower washing temperature) and detergent.

Saving	Soiling/note
<p>Reduced temperature and detergent quantity as per the recommended dosage</p>  <p>Temperature as per the care label and detergent quantity as per the recommended dosage for heavy soiling</p>	<p><b>Light</b> No visible dirt or stains. Clothing has taken on some body odour, e.g.:</p> <ul style="list-style-type: none"> <li>■ Light summer/sports clothing (worn for a few hours)</li> <li>■ T-shirts, shirts, blouses (worn for up to one day)</li> <li>■ Guest bed linen and hand towels (used for one day)</li> </ul>
	<p><b>Normal</b> Visible dirt or a few light stains, e.g.:</p> <ul style="list-style-type: none"> <li>■ T-shirts, shirts, blouses (sweat soaked, worn a few times)</li> <li>■ Towels, bedding (used for up to one week)</li> </ul>
	<p><b>Heavy</b> Dirt and/or stains clearly visible, e.g. tea towels, baby items, work clothing</p>

**Note:** When measuring the amount of all detergents/additives/care products and cleaning agents, please always check the manufacturer's instructions and information. → Page 17

## P+ Programme default settings

The default program settings are displayed on the display panel once the program has been selected.

You can change the default settings.

To do this, repeatedly press the corresponding button until the required setting value is displayed on the display panel.

**Note:** Pressing and holding the button will allow you to automatically scroll through all the setting values to the last value. Pressing it again will allow you to change the setting values again.

You can find an overview of all possible program settings on the supplementary sheet for the installation and operating instructions.

### Temperature

(°C, Temp. °C, Θερμοκρ. °C)

Button depending on the model

Depending on what stage the program is in, you can change the set temperature before and during the program.

The maximum temperature that can be set depends on the program that has been selected.

### Spin speed

(Ⓢ, Ⓢ rpm, Στροφές Ⓢ)

Depending on how far through the program the appliance is, you can change the spin speed (in rpm – revolutions per minute) before and during the program.

**Setting 0:** No final spin; the water is simply pumped out. The laundry stays

## en Programme default settings

wet inside the drum, e.g. for items that are not to be spun.

--- **setting:** Rinse Stop = no final spin; the laundry stays in the water after the final rinse.

You can select "Rinse Stop" to prevent creasing if the laundry will not be taken out of the washing machine immediately after the program has ended.

To resume/end the program

→ *Page 19*

The maximum speed that can be set depends on the model and the program that has been selected.

## Finished in-time

(☺, Λήξη σε ☺)

**Before starting the program**, you can preselect the program end time ("Ready in" time) in hourly increments (h = hour), up to a maximum of 24 hours.

To do this:

1. Select a program.  
The program duration will be displayed for the selected program, e.g. **2:30** (hours:minutes).
2. Press the **Finished in-time** button repeatedly until the required number of hours is displayed.
3. Press the  button.  
The program will now start.  
The selected number of hours (e.g. **8 h**) is shown on the display panel and counts down until the wash program starts. The duration of the program will then be displayed.

**Note:** The program duration is automatically adjusted when the program is running.

Certain factors can affect the program duration, e.g.:

- Program settings,
- Detergent dosage (additional rinse cycles may be required due to foaming),
- Load size/type of fabrics (water absorption differs),
- Imbalances (e.g. due to fitted sheets) are eliminated by rotating the drum briefly several times,
- Fluctuations in power supply,
- Water pressure (inflow rate).

**Once the program has been started**,

you can change the preselected number of hours as follows:

1. Press the  button.
2. Use the **Finished in-time** button to change the number of hours.
3. Press the  button.

**Once the program has been started**,



you can add more laundry or remove laundry as required. → *Page 18*

## **P+** Additional programme settings

You can find an overview of all the possible additional settings on the printed supplement for the installation and operating instructions.

The settings vary depending on the model.

### Speed Eco

( , Speed/Eco, Speed Eco Perfect)

Button with two possible settings for adapting the selected program:

- **Speed**  
Washing in a shorter time while achieving a washing result that is consistent with, but uses more energy than, the selected program, without the Speed Eco setting.  
**Note:** Do not exceed the maximum load.
- **Eco**  
Energy-optimised washing by reducing the temperature while achieving a washing result that is consistent with the selected program, without the Speed Eco setting.

Press the button to do this. First of all, you can select the **Speed** setting. If you press the button again, the **Eco** setting is active. The respective symbol is shown in the display when the setting is activated.

If you press the button again, no setting is active.

### Easy-Iron

()

Button depends on the model

Reduces creasing by means of a special spin sequence followed by fluffing and reduced spin speed.

**Note:** The laundry retains an elevated level of residual moisture.

### Water&Rinse+

(, Water Plus , Aqua Plus, Rinse Plus , Περισσότ. νερό)

Button depends on the model

Higher water level and additional rinse cycle for particularly sensitive skin and/or for areas with very soft water.

### Prewash

(, Πρόπλυση)

Button depending on the model

For heavily soiled laundry.

**Note:** Pour detergent into compartments **I** and **II**.



## Operating the appliance

### Preparing the washing machine

**Note:** The washing machine **must be correctly installed** and **connected**.  
From → *Page 28*

1. Connect the mains plug.
2. Turn on the water tap.
3. Open the door.
4. Check that the drum is completely drained. Drain if necessary.



### Select programme/switch on the appliance

**Note:** If you have activated the childproof lock, you must first deactivate it, before you can set a program.

Use the program selector to select the required program. Can be rotated in either direction.

The appliance is switched on.

The **program default settings** for the selected program appear in the display panel:

- Temperature\*,
- The maximum load and the duration of the program (alternately)
- Energy consumption\*.

\*depending on the model

### Change the programme default settings

You can use or change the default settings for this wash cycle.

To do this, repeatedly press the corresponding button until the required setting is displayed.

The settings are activated without needing to be confirmed.

The settings are not retained after the washing machine is switched off.

Default program settings → *Page 13*

### Select additional programme settings

By selecting additional settings, you can better adapt the washing process to the items of laundry you are washing.

The settings can be selected or deselected depending on how far the program has progressed.

The button indicator lights will be lit if a setting has been activated.

The settings are not retained after the washing machine is switched off.

Additional program settings  
→ *Page 15*

### Placing laundry into the drum

#### **Warning** **Danger of death!**

Items of laundry pretreated with cleaning agents that contain solvents, e.g. stain remover/cleaning solvent, may cause an explosion after being loaded into the washing machine. Hand-rinse items of laundry thoroughly beforehand.

**Notes**

- Mix items of laundry of varying sizes. Laundry items of different sizes distribute themselves better during the spin cycle. Individual items of laundry may lead to imbalances.
  - Observe the specified maximum load. Overfilling has a negative impact on the washing result and promotes creasing.
1. Place presorted items of laundry unfolded in the washing drum.
  2. Make sure that no items of laundry are trapped between the washing machine door and the rubber seal, and close the door.



**Measure and add detergent and care products**

**Caution!**

**Damage to the appliance**

Cleaning agents and agents for pretreating laundry (e.g. stain removers, prewash sprays, etc.) may cause damage if they come into contact with the surfaces of the washing machine. Do not allow these agents to come into contact with the surfaces of the washing machine. If necessary, immediately wipe away spray residue and other residues/droplets with a damp cloth.

**Dosing**

Dose the detergents and care products according to:

- Water hardness (ask your water supply company)
- The manufacturer's instructions on the packaging

- The amount of laundry
- Soiling → Page 13

**Filling**

**Warning**  
**Eye/skin irritation!**

Detergent and care products may spray out if the detergent drawer is opened while the machine is in operation. Open the drawer carefully. Rinse eyes/skin thoroughly if they come into contact with detergents or care products. If swallowed accidentally, seek medical advice.

**Note:** Dilute viscous fabric softener and fabric conditioner with water to prevent blockages.

Pour the detergent and care products into the appropriate compartments:

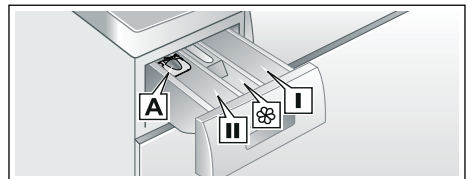

- Measuring aid **A** for liquid detergent
- Dispenser **II** Detergent for the main wash, water softener, bleach, stain remover
- Dispenser  Softener, starch, do not exceed **max.**
- Dispenser **I** Detergent for prewash

1. Pull out the detergent drawer as far as possible.
2. Add detergent and/or care products.
3. Close the detergent drawer.

**Measuring aid\* for liquid detergent**

Position the measuring aid for dosing the correct amount of liquid detergent:

1. Pull out the detergent drawer. Press down the insert and fully remove the drawer.
2. Slide the measuring aid forwards, fold it down and click it into place.
3. Reinsert the drawer.

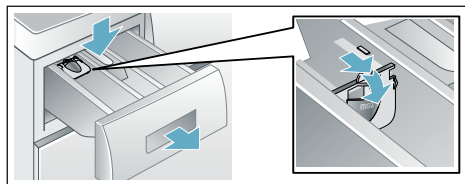

**Note:** Do not use the measuring aid for gel detergents and washing powder, or for programs with prewash or when the Ready in time is selected.

## Start the programme

Press the  button. The indicator lamp lights up and the program starts.

The display panel shows the Ready in time while the program is running or the program duration and the program progress symbols once the wash cycle has started.

Display panel → Page 10



### **Note: Foam detection**

If the  symbol also lights up in the display panel, the washing machine has detected too much foam during the wash cycle and automatically activated additional rinse cycles to remove the foam.

Add less detergent to the next wash cycle with the same load.



If you want to lock the program to prevent it from being inadvertently adjusted, you can select the childproof lock as follows.

## Childlock

( 3 sec.,  3 δεϋτ.)

You can lock the washing machine to prevent the functions you have set from being changed inadvertently. To do this, activate the childproof lock once the programme has started.

To **activate/deactivate**, press and hold the **Spin speed** and **Finished in-time** buttons at the same time for approx. 3 seconds. The  symbol will appear on the display panel.

-  lit up: The childproof lock is active.
-  flashing: The childproof lock is active and the programme selector has been adjusted. To deactivate the childproof lock, reset the programme selector to the initial programme. The symbol will light up again.

**Note:** Do not turn the program selector beyond the "off" position, otherwise the programme will stop.

**Note:** The childproof lock remains active after the appliance is switched off. You must deactivate the childproof lock whenever you want to start a new programme.

## Adding laundry

Once the programme has been started, you can add more laundry or remove laundry as required.

Press the  button to do this.

The  button indicator light will flash and the machine will check whether it is possible to add more laundry.

If

- the  symbol goes out on the display panel, it is possible to add more laundry.

- the  symbol lights up on the display panel, it is not possible to add more laundry.

**To resume the programme, press the  button.** The programme will resume automatically.

**Notes**

- Do not leave the door open for too long when adding more laundry as water from the laundry may leak out.
- For safety reasons, the door remains locked when the water level or temperature is high, or while the drum is turning, and it is not possible to add more laundry during this time.

**Changing the programme**



1. Press the .
2. Select a different program.
3. Press the  button. This starts the new program from the beginning.

**Cancel the programme**



For programs at high temperature:

1. Press the .
2. To cool down laundry: Select  **Rinse**.
3. Press the .

For programs at low temperature:



1. Press the .
2. Select  **Spin/Drain//Spin/Empty**.
3. Press the .

**Programme end during rinse hold**

----  appears in the display panel and the indicator lamp of the  button flashes.

Continue the program by:

- Pressing the  button or

- Selecting a spin speed or setting the program selector to  **Spin/Drain//Spin/Empty**  and then pressing the .

**Programme end**

**End** appears on the display panel and the  button indicator light is off.

**Removing laundry/switching off the appliance**

1. Open the door and remove the laundry.
2. Turn the program selector to **Off** . The appliance is switched off.
3. Turn off the tap. **Note:** Not required for Aqua-Stop models.

**Notes**

- Do not leave any items of laundry in the drum. They may shrink in the next wash or discolour another item.
- Remove any foreign objects from the drum and the rubber seal – risk of rusting.
- Wipe the rubber seal dry.

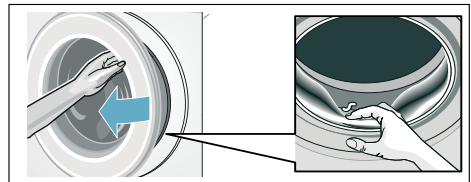

- Leave the door and detergent drawer open so that any residual water can evaporate.
- Always wait until the program ends, as the appliance could still be locked. Then switch the appliance on and wait for it to unlock.
- If the display panel goes off at the end of a program, the energy-saving mode is active. Press any button to activate the panel.

## Sensors

### Automatic load sensing

The automatic load sensing function adapts the water consumption ideally to each programme depending on the type of fabric and the load.

### Unbalanced load detection system

The automatic unbalanced load detection system detects imbalances and ensures even distribution of the laundry by repeatedly starting and stopping drum spinning.

If the laundry is extremely unevenly distributed, the speed is reduced or the spin cycle is not performed for safety reasons.

**Note:** Place large and small items of laundry evenly in the drum. → Page 25

### VoltCheck

depending on the model

The automatic voltage control system detects an unauthorised voltage under-usage. The colon on the Ready in display is flashing. → Page 10

Once the supply voltage is stable again, the colon of the Ready in display lights up (Normal mode).

The detected voltage under-usage is indicated in the further program sequence by all three points lighting up in the display.



**Note:** Voltage under-usages can for example result in program extensions and/or a non-satisfactory spin result.

## Setting the signal



You can change the following settings:

- The volume of the buttons and information signals (e.g. at the end of the program) and/or
- The volume of the button signals.

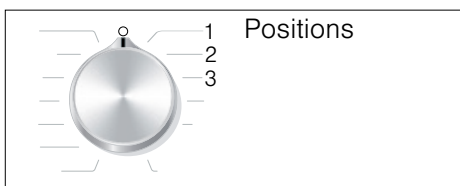
You will need to activate the setting mode in order to change these settings.



### Activating the setting mode

1. Select the  **Cottons** program to position 1. The washing machine is switched on.
2. Press the  button and, at the same time, turn the program selector clockwise to position 2. Release the button.

The setting mode is activated and the preset volume for the information signals appears in the display panel (e.g. at the end of the program).

### Changing the volume

Use the **Finished in-time** + or - button to change the following settings at the corresponding program selector positions:

- 2: The volume of the information signals and/or
- 3: The volume of the button signals.



0 = off, 1 = quiet,  
2 = medium, 3 = loud,  
4 = very loud

### Exiting setting mode

You can now end the process and set the program selector to the **Off** position. The settings are saved.



## Cleaning and maintenance

### Warning

#### Danger of death!

There is a risk of electric shock if you touch live components. Switch off the appliance and pull out the mains plug.

### Warning

#### Risk of poisoning!

Toxic vapours can be produced by cleaning agents that contain solvents, e.g. cleaning solvent. Do not use cleaning agents that contain solvents.

### Caution!

#### Damage to the appliance

Cleaning agents that contain solvents, e.g. cleaning solvent, can damage surfaces and components in the machine. Do not use cleaning agents that contain solvents.

#### Prevent detergent residue from building up and odours from forming by following these instructions:

#### Notes

- Ensure the room in which the washing machine is set up is well ventilated.
- Leave the door and detergent dispenser tray open slightly when the washing machine is not in use.
- Occasionally run a wash using the **Cottons 60 °C** programme and powder detergent.

## Machine housing/control panel

- Wipe the housing and the control panel with a soft, damp cloth.
- Remove the detergent residue immediately.
- Do not clean with a water jet.

## Drum

Use chlorine-free cleaning agents, do not use steel wool.

If there are odours in the washing machine, or to clean the drum, run the **Drum Clean 90 °C** or **Cottons 90 °C** program without laundry. Add washing powder.

## Descaling

Descaling should not be necessary if the detergent is measured out correctly. However, if it is required, follow the manufacturer's instructions for the descaling agent. Suitable descalers can be obtained via our website or from our after-sales service.

## Detergent drawer and housing

If the washing machine contains detergent or fabric softener residues:

1. Pull out the detergent drawer. Press down the insert and fully remove the drawer.
2. To remove the insert: Push the insert upwards from below with your finger.

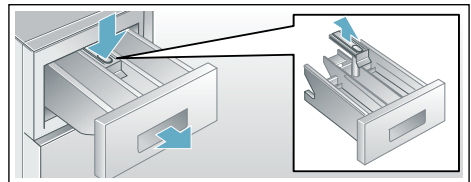

3. Clean the detergent dispenser tray and insert with water and a brush, and dry it. Clean the inside of the housing as well.
4. Fit the insert and lock it in place (push the cylinder onto the guide pin).
5. Push in the detergent drawer.

**Note:** Leave the detergent drawer open so that any residual water can evaporate.

## Detergent solution pump blocked

### **Warning** **Risk of scalding!**

When you wash at high temperatures, the water gets very hot. If you come into contact with the hot water, you may be scalded.

Allow the water to cool down.

1. Turn off the water tap so that no more water can flow in and has to be drained via the drain pump.
2. Switch off the appliance. Disconnect the mains plug.
3. Open and remove the service flap.

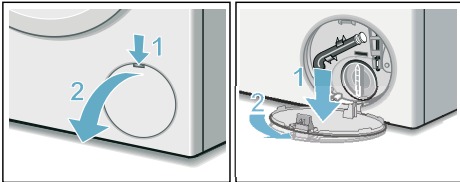

4. Take the drain hose out of the retainer.  
Remove the sealing cap, allow the detergent solution to flow out into a suitable container.  
Replace the sealing cap and place the drainage hose in the retainer.

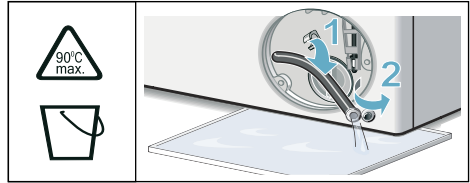

5. Carefully unscrew the pump cover, residual water may leak out. Clean the interior, pump cover thread and pump housing. The impeller in the detergent solution pump must be able to rotate. Refit the pump cover and screw it on tightly. The handle must be in a vertical position.

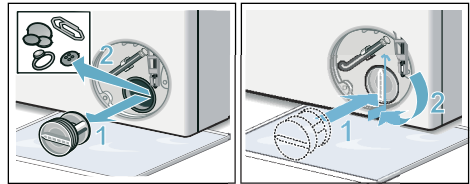

6. Place the service flap back on, lock it into place, and close it.

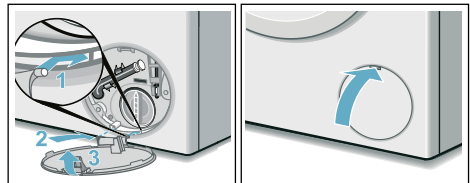

**Note:** To prevent unused detergent from flowing straight into the drain during the next wash: Pour 1 litre of water into compartment II and start the  **Empty** programme.

## The drain hose at the siphon is blocked

1. Switch off the appliance. Disconnect the mains plug.
2. Loosen the hose clamp. Carefully remove the drain hose, residual water may leak out.

3. Clean the drainage hose and siphon connecting piece.

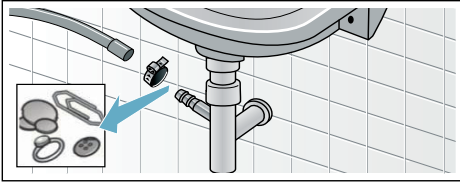

4. Reattach the drainage hose and secure the connection using the hose clamp.

### Filter in the water supply blocked

First, reduce the water pressure in the supply hose:

1. Turn off the tap.
2. Select any program (except Rinse// Spin/Empty).
3. Press the  button. Allow the program to run for approximately 40 seconds.
4. Turn the program selector to **Off**. Pull out the mains plug.
5. Clean the filter on the tap: Disconnect the hose from the tap. Clean the filter with a small brush.

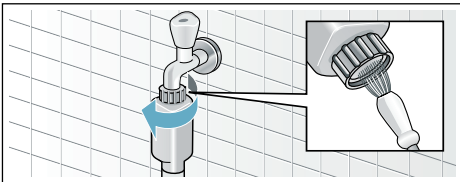

6. For standard and Aqua-Secure models, clean the filter on the rear of the appliance: Remove the hose from the rear of the appliance. Use pliers to remove the filter and then clean it.

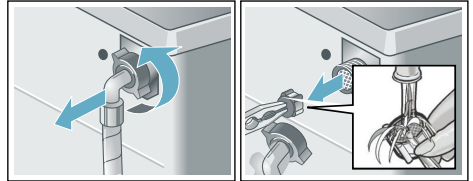

7. Connect the hose and check for leaks.

## Faults and what to do about them.

### Emergency release

e.g. in the event of a power cut

The programme will continue running when the power supply has been restored.

However, if the laundry has to be removed, the washing machine door can be opened as follows:

#### **Warning** **Risk of scalding!**

When you are washing at high temperatures, there is a risk of scalding if you come into contact with detergent solution and laundry.

If possible, leave it to cool down.

#### **Warning** **Risk of injury!**

You may injure your hands if you reach into the drum while it is turning.

Do not reach into the drum when it is turning.

Wait until the drum has stopped turning.

#### **Caution!** **Water damage**





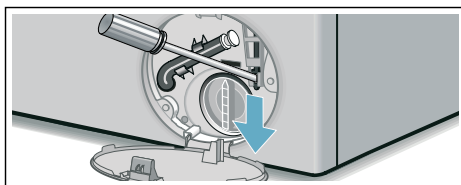

Any escaping water may cause water damage.

Do not open the washing machine door if water can be seen through the glass.

1. Switch off the appliance. Disconnect the mains plug.
2. Drain the detergent solution.
3. Pull the emergency release downwards with a tool and release. The washing machine door can then be opened.











## Information on the display panel





Display	Cause/remedy
 is lit up	<ul style="list-style-type: none"><li>■ The temperature is too high. Wait until the temperature drops.</li><li>■ The water level is too high. It is not possible to add laundry. Close the door immediately if necessary. Press the  button to continue the program.</li></ul>
 flashes	<ul style="list-style-type: none"><li>■ Laundry may be trapped. Open and close the door again and press the  button.</li><li>■ If necessary, push the door closed or remove the trapped laundry and then push it closed again.</li><li>■ If necessary, switch the appliance off and then on again; set a programme and apply the settings you require; start the programme.</li></ul>
 is lit up	<ul style="list-style-type: none"><li>■ Turn on the cold water tap fully.</li><li>■ The supply hose is kinked/jammed. Correct the position of the hose.</li><li>■ The water pressure is too low. Clean the filter. → Page 23</li></ul>
	The childproof lock is activated – deactivate it.

Display	Cause/remedy
 is lit up	Too much foam has been detected and additional rinse cycles have been activated. Add less detergent to the next wash cycle with the same load. → Page 18
: the "Ready in" time flashes	Mains voltage is too low.
.the "Ready in" time flashes	Undervoltage during the wash programme. The programme duration is extended. → Page 20
E:18	<ul style="list-style-type: none"> <li>■ The drain pump is blocked. Clean the drain pump. → Page 22</li> <li>■ The drain hose/drain pipe is blocked. Clean the drain hose at the siphon. → Page 22</li> </ul>
E:23	There is water in the base trough; the appliance is leaking. Turn off the tap. Call the after-sales service.
E:32	flashes alternately with <b>End</b> at the end of the programme. Not a fault – the unbalanced load detection system has interrupted the spin cycle because the laundry is unevenly distributed. Distribute small and large items of laundry evenly in the drum. Spin the laundry again if necessary.
E:93 (on models with hot and cold water connections)	The hot water pressure is too low: <ul style="list-style-type: none"> <li>■ Turn on the hot water tap fully.</li> <li>■ The supply hose for hot water is kinked/trapped. Correct the position of the hose.</li> <li>■ Clean the filter. → Page 23</li> <li>■ The supply hose for hot water is not connected correctly. The appliance will only be operated with cold water. Display only appears during the first wash cycle after installation of the appliance without a hot water connection. → Page 32</li> </ul>
Other displays	Switch off the appliance, wait for five seconds and then switch it on again. If the display appears again, call the after-sales service. → Page 27

## Faults and what to do about them.

Faults	Cause/remedy
Water is leaking from the machine.	<ul style="list-style-type: none"> <li>■ Attach the drain hose correctly or replace it.</li> <li>■ Tighten the threaded joint on the supply hose.</li> </ul>
Water is not flowing in. Detergent is not being dispensed.	<ul style="list-style-type: none"> <li>■ Have you pressed the  button?</li> <li>■ Is the tap turned on?</li> <li>■ Could the filter be clogged? Clean the filter. → Page 23</li> <li>■ Is the supply hose kinked or trapped?</li> </ul>
The door will not open.	<ul style="list-style-type: none"> <li>■ The safety function is active. Do you want to stop the programme? → Page 19</li> <li>■ Is the  childproof lock activated? Deactivate it. → Page 18</li> <li>■ Is ---- selected (Rinse Stop = no final spin)? → Page 19</li> <li>■ Can the door only be opened by the emergency release? → Page 24</li> </ul>

Faults	Cause/remedy
The programme will not start.	<ul style="list-style-type: none"> <li>■ Have you pressed the  button?</li> <li>■ Is <b>Finished in-time</b> selected?</li> <li>■ Is the door closed?</li> <li>■ Is the  childproof lock activated? Deactivate it. → <i>Page 18</i></li> </ul>
The drum briefly jerks or judders after the programme has started.	Not a fault – the internal motor test may cause the drum to jerk or judder briefly when the wash programme starts.
The water is not draining.	<ul style="list-style-type: none"> <li>■ Is <b>---</b> selected (Rinse Stop = no final spin)? → <i>Page 19</i></li> <li>■ Clean the drain pump. → <i>Page 22</i></li> <li>■ Clean the drain pipe and/or the drain hose.</li> </ul>
Water is not visible in the drum.	Not a fault – the water is below the visible area.
The spin result is not satisfactory. Laundry is wet/too damp.	<ul style="list-style-type: none"> <li>■ Not a fault – the unbalanced load detection system has interrupted the spin cycle because the laundry is unevenly distributed. Distribute small and large items of laundry evenly in the drum.</li> <li>■ Is Anti-crease (depending on the model) selected?</li> <li>■ Is the selected speed too low?</li> </ul>
The appliance restarts the spin cycle several times.	Not a fault – the unbalanced load detection system is adjusting an imbalance.
The programme is taking longer than usual.	<ul style="list-style-type: none"> <li>■ Not a fault – the unbalanced load detection system is adjusting an imbalance by repeatedly redistributing the laundry.</li> <li>■ Not a fault – the foam detection system is active – a rinse cycle has been activated.</li> </ul>
The length of the programme changes during the wash cycle.	Not a fault – the programme sequence is optimised for the specific washing process. This may change the length of the programme shown on the display panel.
Water remaining in the care product compartment  .	<ul style="list-style-type: none"> <li>■ Not a fault – the effectiveness of the care product is not affected.</li> <li>■ Clean the insert if necessary.</li> </ul>
Odours in the washing machine.	<p>Depending on the model, run the  <b>Drum Clean90 °C</b> or  <b>Cottons90 °C</b> program without laundry.</p> <p>Add standard washing powder or a detergent that contains bleach.</p> <p><b>Note:</b> To prevent foaming, only use half the amount of detergent recommended by the detergent manufacturer. Do not use detergents intended for woollens or delicates.</p>
The  symbol is lit on the display panel. Foam may also be leaking from the detergent drawer.	<p>Have you used too much detergent?</p> <p>Mix one tablespoon of fabric softener with 1/2 litre of water and pour it into compartment <b>II</b> (not suitable for outdoor clothing, sportswear or items made with down).</p> <p>Use less detergent in the next wash cycle.</p>

Faults	Cause/remedy
Loud noises, vibrations and machine “wandering” during the spin cycle.	<ul style="list-style-type: none"> <li>■ Is the appliance level? Make the appliance level. → <i>Page 33</i></li> <li>■ Are the appliance's feet secured? Secure the appliance's feet. → <i>Page 33</i></li> <li>■ Have the transport braces been removed? Remove the transport braces. → <i>Page 30</i></li> </ul>
The display panel/indicator lights do not work while the appliance is running.	<ul style="list-style-type: none"> <li>■ Has there been a power failure?</li> <li>■ Have the fuses blown/has the circuit breaker tripped? Switch on the circuit breaker/replace the fuses.</li> <li>■ If the fault occurs repeatedly, call the after-sales service.</li> </ul>
There is detergent residue on the laundry.	<ul style="list-style-type: none"> <li>■ Some phosphate-free detergents contain water-insoluble residue.</li> <li>■ Select  <b>Rinse</b> or brush the laundry after washing.</li> </ul>
The  symbol is lit in the display panel when paused.	<ul style="list-style-type: none"> <li>■ The water level is too high. It is not possible to add laundry. Close the door immediately if necessary.</li> <li>■ Press the  button to resume the programme.</li> </ul>
The  symbol in the display panel is off when paused.	The door is unlocked. It is possible to add laundry.
If you cannot rectify a fault yourself (after switching the machine off and then on again) or a repair is required:	
<ul style="list-style-type: none"> <li>■ Switch off the appliance and pull the mains plug out of the socket.</li> <li>■ Turn off the tap and call the after-sales service.</li> </ul>	



## After-sales service

If you cannot rectify a fault yourself, contact customer services. → Cover page

We will always find an appropriate solution in order to avoid unnecessary visits by engineers.

Please give customer services the product number (E no.) and the production number (FD) of the appliance.

E-Nr. \_\_\_\_\_ FD \_\_\_\_\_

E no.      Product number  
FD        Production number

You can find this information  
\*depending on the model:

On the inside of the door\*/in the opened service flap\* and on the rear of the appliance.

### Trust the expertise of the manufacturer.

Contact us for assistance. By doing so, you will ensure that the repairs are carried out by trained service personnel using genuine spare parts.

## Technical data

### Dimensions:

60 x 55 x 85 cm  
(width x depth x height)

### Weight:

66 - 73 kg\*

### Mains connection:

Nominal voltage: 220 - 240 V / 50 Hz

Nominal current: 10 A / 13 A\*

Nominal power: 1900 - 2300 W

### Water pressure:

100 - 1000 kPa (1 - 10 bar)

### Power consumption when switched off:

0.12 W

### Power consumption when left on:

0.43 W

\*depending on the model

## Positioning and connecting

### Included with the appliance

**Note:** Check the machine for transport damage. Never use a damaged machine. If you have any complaints, contact the dealer from whom you purchased the appliance or our customer services. → Page 27

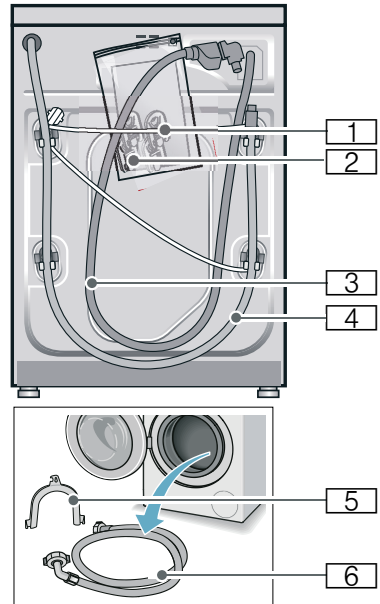

- 1** Mains cable
- 2** Bag:
  - Installation and operating instructions
  - Customer services location directory\*
  - Warranty\*
  - Cover caps for openings after the transport braces have been removed
- 3** Water supply hose on AquaStop models

- 4 Water drain hose
  - 5 Elbow for securing the water drain hose\*
  - 6 Cold water supply hose for models standard/Aqua-Secure, for models with hot water connection additionally a hot water supply hose
- \* depending on the model

**In addition**, a hose clamp (24 - 40 mm diameter, available from specialist dealers) is required to connect the water drain hose to a siphon.

### Useful tools

- Spirit level for aligning
- Spanner with:
  - WAF13 for loosening the transport braces, and
  - WAF17 for aligning the appliance feet

## Safety instructions

### **Warning**

#### **Risk of injury!**

- The washing machine is very heavy. Be careful when lifting/transporting the washing machine.
- When the washing machine is lifted by its protruding parts (e.g. the washing machine door), the components may break off and cause injuries. Do not lift the washing machine by protruding parts.
- If the hose and mains cables are not routed properly, there is a risk of tripping and injury. Lay hoses and cables in such a way that there is no risk of tripping.

### **Caution!**

#### **Damage to the appliance**

Frozen hoses may rip/burst. Do not install the washing machine in areas exposed to frost or outdoors.

### **Caution!**

#### **Water damage**

The connection points for the water supply hose and water drain hose are under high water pressure. To prevent leaks and water damage, you must follow the instructions in this section.

### **Notes**

- In addition to the safety information listed here, the local water and electricity supplier may have special requirements.
- If in doubt, have the appliance connected by a specialist.

## Installation surface

**Note:** The washing machine be stable so that it does not move around.

- The installation surface must be firm and level.
- Soft floors/floor coverings are not suitable.

## Installation on a base or a wooden joist floor

### **Caution!**

#### **Damage to the appliance**

The washing machine may "wander" and tip/topple from the base when spinning.

The feet of the appliance must be secured with holding brackets. Order no. WMZ 2200, WX 9756, Z 7080X0

**Note:** On wooden joist floors, install the washing machine:

- In a corner, if possible,
- On a water-resistant wooden board (min. 30 mm thick) which is screwed tightly to the floor.

## Installation on a platform with drawer

Platform order no.: WMZ 20490, WZ 20490, WZ 20510, WZ 20520

## Installing the appliance in a kitchenette

### **Warning** **Danger of death!**

There is a risk of electric shock if you touch live components. Do not remove the appliance covering plate.

### Notes

- Recess width of 60 cm required.
- Only install the washing machine underneath a continuous worktop that is securely connected to adjacent cabinets.

## Removing the transport locks

### **Caution!** **Damage to the appliance**

- The machine is secured for transportation using transport locks. If the transport locks are not removed, the drum, for example, may become damaged when the machine is operated. Before using the appliance for the first time, make sure that you completely remove all four transport locks. Keep the locks in a safe place.
- To prevent transport damage from occurring if the appliance is moved at a later date, you must refit the transport locks before transporting the appliance.

**Note:** Keep the screws and sleeves in a safe place.

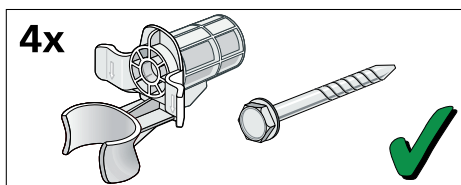

1. Take the hoses out of the holders.

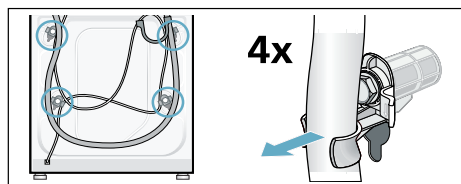

2. Unscrew and remove all four transport brace screws. Remove the sleeves. To do this, remove the mains cable from the holders.

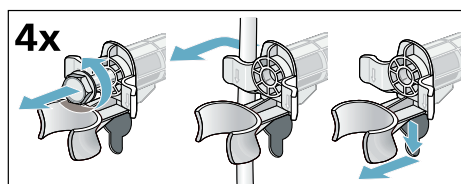

3. Fit the covers. Lock the covers firmly in place by applying pressure to the snap-in hooks.

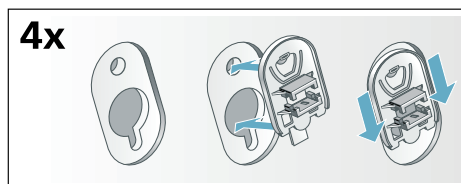

## Hose and cable lengths

### ■ Left-hand connection

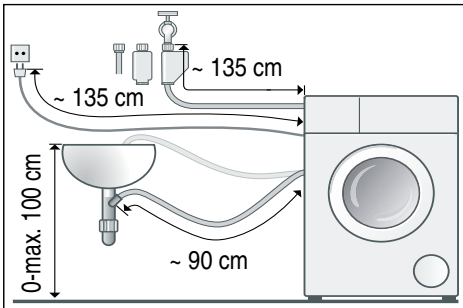

### ■ Right-hand connection

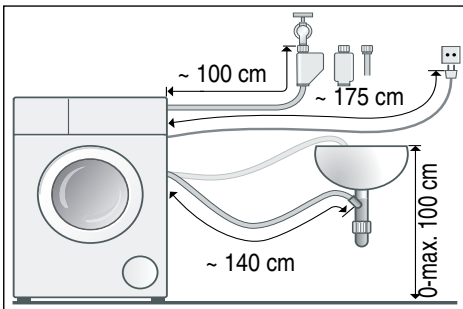

**Tip:** The following are available from specialist dealers/the after-sales service:

- An extension for Aqua-Stop or cold water supply hose (approx. 2.50 m); order no. WMZ2380, WZ10130, CZ11350, Z7070X0
- A longer supply hose (approx. 2.20 m) for standard model

## Water inlet

### **⚠ Warning** **Danger of death!**

There is a risk of electric shock if you touch live components. Do not immerse the Aqua-Stop safety valve in water (it contains an electric valve).

Observe the following when connecting the machine:

### Notes

- With a cold water connection, only operate the washing machine using cold mains water.
- With a hot water connection, operate the washing machine with hot and cold mains water, with a maximum temperature of 60 °C.
- Do not connect the machine to the mixer tap of an unpressurised hot-water boiler.
- Do not use a used supply hose. Only use the supply hose supplied or one that was purchased from an authorised specialist retailer.
- Do not bend, squash, modify or cut through the water supply hose (otherwise its strength is no longer guaranteed).
- Only tighten the screw fitting by hand. If the screw connections are tightened too much with a tool (pliers), the thread may get damaged.

### Optimum water pressure in the supply network

**At least** 100 kPa (1 bar)

**Maximum** 1000 kPa (10 bar)

When the tap is open, the water flow rate is at least 8 l/min.

If the water pressure is higher than this, a pressure-reducing valve must be installed.

### Cold water connection

**Note:** With a cold water connection, only operate the washing machine using cold mains water.

Connect the water supply hose to the tap (26.4 mm = 3/4") and to the appliance (not necessary for Aqua-Stop models as this is permanently installed):

- Model: **Standard**

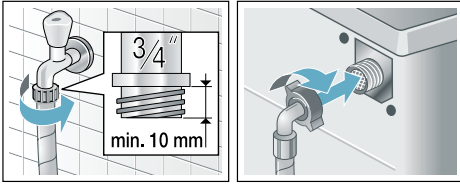

- Model: **Aqua-Secure**

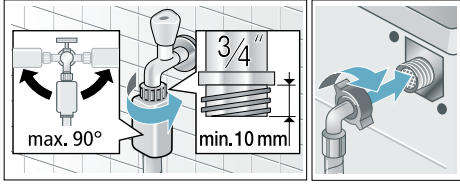

- Model: **Aqua-Stop**

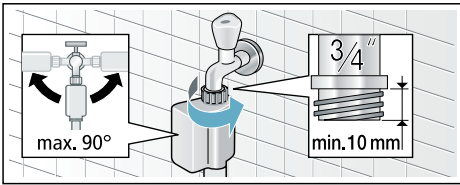

**Note:** Turn on the tap carefully, checking the leak tightness of the connection points. The screw connection is under mains water pressure.

### Hot and cold water connection

#### Notes

- With a hot water connection, operate the washing machine with hot and cold mains water, with a maximum temperature of 60 °C.
- Red hot water supply hose on the hot water tap and red valve on the appliance
- White cold water supply hose on the cold water tap and white valve on the appliance

### Connection to the water pipes ( $\frac{3}{4}$ " = 26.4 mm)

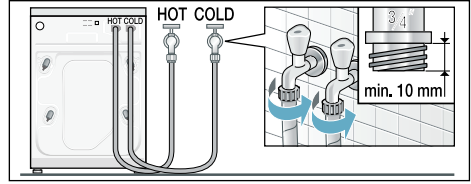

### Connection to the appliance

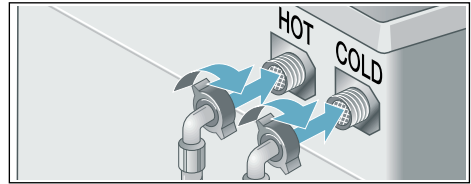

### Connection of hot water appliances only to cold water

If there is no hot water connection, you need a Y-piece, available from customer service with single part number: 050871.

- Connect both supply hoses to the cold water tap with a Y-piece and
- connect both supply hoses to the appliance.

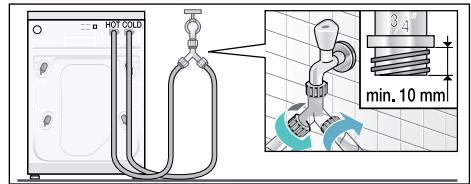

**Note:** Carefully turn on the taps and check that the connection points are not leaking. The screw connection is under mains water pressure.

## Water outlet

### Caution! Water damage

If the drain hose slips out of the wash basin or the connection point during draining due to high water pressure, any escaping water may cause water damage.

Secure the drain hose so that it cannot slip out.

**Note:** Do not kink the water drain hose or put strain on it lengthways.

You can lay the water drain hose as follows:

#### ■ Outlet in a sink

### Warning Risk of scalding!

When you are washing at high temperatures, there is a risk of scalding if you come into contact with hot detergent solution e.g. if hot detergent solution is being drained into a wash basin.

Do not reach into the hot detergent solution.

### Caution!

#### Damage to the appliance/fabrics

If the end of the drain hose is immersed in the drained water, water may be sucked back into the appliance and may damage the appliance/fabrics.

Make sure that:

- The plug does not block drainage from the sink.
- The end of the drain hose is not immersed in the drained water.
- The water drains away quickly enough.

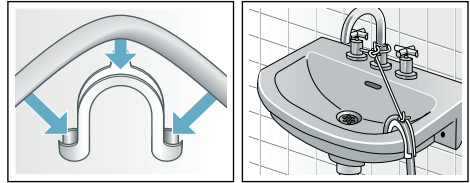

#### ■ Drainage into a siphon

The connection point must be secured using a hose clamp with a diameter of 24-40 mm (available from specialist dealers).

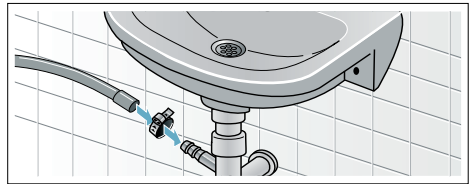

#### ■ Outlet into a plastic pipe with rubber bushing or into a drainage pit

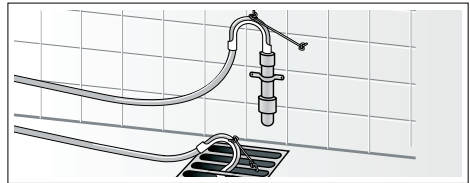

## Levelling

Level the appliance using a spirit level.

Incorrect levelling may result in intense noise, vibrations and "wandering".

1. Loosen the lock nuts using a wrench, by turning it in a clockwise direction.
2. Check the alignment of the washing machine with a spirit level, and adjust it if necessary. Change the height by turning the appliance feet. All four appliance feet must stand firmly on the ground.
3. Tighten the lock nut against the housing.

In doing so, hold the foot tight and do not adjust its height. The lock nuts on all four appliance feet must be screwed tightly against the housing.

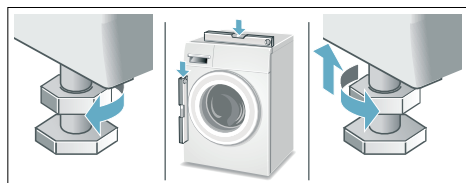

## Electrical connection

### **Warning** **Danger of death!**

There is a risk of electric shock if you touch live components.

- Never touch or hold the mains plug with wet hands.
- Only pull out the mains cable by the plug and never by the cable, as this could damage it.
- Never unplug the mains plug during operation.

Observe the following information and ensure that:

### Notes



- The mains voltage and voltage indicated on the washing machine (rating plate) are the same. The connected load and fuse required are specified on the rating plate.
- The washing machine is only connected to an alternating current via a properly installed earthed socket.
- The mains plug fits the socket.
- The cable cross-section is adequate.
- The earthing system is properly installed.
- The mains cable is only replaced by a qualified electrician (if this is necessary). Replacement mains cables are available from the after-sales service.
- No multiple plugs/couplings or extension cables are used.

- If an earth-leakage circuit breaker is used, only a type which displays this symbol is used:  Only this symbol guarantees compliance with the currently applicable regulations.
- The mains plug must be freely accessible at all times. If this is not possible, in order to comply with the relevant safety regulations, a switch (2-pole switch-off) must be built into the permanent installation in accordance with electrical installation regulations.
- The mains cable is not bent, squashed, modified, cut through, or in contact with heat sources.

## Before washing for the first time

The washing machine was thoroughly tested before leaving the factory. To remove any water that may be left over from the test, run the first wash cycle **without** any laundry.

### Notes

- The washing machine **must be correctly installed and connected.** (from → Page 28).
  - Never use a damaged machine. Inform customer services.
1. Check the machine.
  2. Remove the protective film from the control panel.
  3. Connect the mains plug.
  4. Turn on the tap.
  5. Close the door (do not load any laundry).
  6. Depending on the model, run the  **Drum Clean 90 °C** or  **Cottons 90 °C** program.
  7. Open the detergent drawer.
  8. Pour approximately 1 litre of water into compartment **II**.
  9. Pour standard detergent into compartment **II**.

**Note:** To prevent foaming, only use half the amount of detergent recommended by the detergent manufacturer. Do not use detergent designed for wool or delicates.

10. Close the detergent drawer.
11. Press the  button.
12. When the program ends, switch off the appliance.

**Your washing machine is now ready to use.**

## Transportation

e.g. when moving home

### Preparatory work:

1. Turn off the water tap.
2. Reduce the water pressure in the supply hose.  
Maintenance – filter in the water supply → *Page 23*
3. Drain the remaining detergent solution.  
Maintenance – detergent solution pump blocked → *Page 22*
4. Disconnect the washing machine from the mains.
5. Remove the hoses.

### Installing the transport locks:

1. Remove the covers and keep them in a safe place.  
Use a screwdriver if necessary.

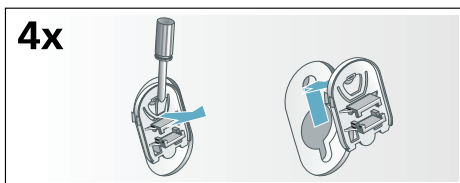

2. Insert all four sleeves.  
Clip the mains cable securely in the holders. Insert and tighten the screws.

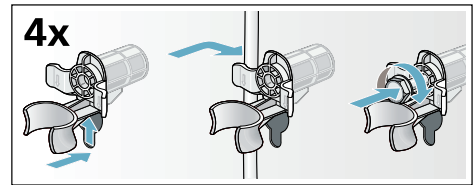

**Before switching on the appliance again:**

### Notes

- The transport braces **must** be removed.
- To prevent unused detergent from flowing straight into the drain during the next wash: Pour approx. 1 litre of water into compartment **II** and start the  **Drain/Empty** program.



## Thank you for buying a Bosch Home Appliance!

Register your new device on MyBosch now and profit directly from:

- **Expert tips & tricks for your appliance**
- **Warranty extension options**
- **Discounts for accessories & spare-parts**
- **Digital manual and all appliance data at hand**
- **Easy access to Bosch Home Appliances Service**

Free and easy registration – also on mobile phones:

[www.bosch-home.com/welcome](http://www.bosch-home.com/welcome)



## Looking for help? You'll find it here.

Expert advice for your Bosch home appliances, need help with problems or a repair from Bosch experts.

Find out everything about the many ways Bosch can support you:

[www.bosch-home.com/service](http://www.bosch-home.com/service)

**Contact data of all countries are listed in the attached service directory.**

### **Robert Bosch Hausgeräte GmbH**

Carl-Wery-Straße 34

81739 München, GERMANY

[www.bosch-home.com](http://www.bosch-home.com)



**9000979140** (0003)

en