

Sunco

Lighting made better.

User Manual
LED Exit Sign

SKU: EX-RED
EX-GRN



support@sunco.com
(844) 334-9938



What's in the Box?

Exit Sign

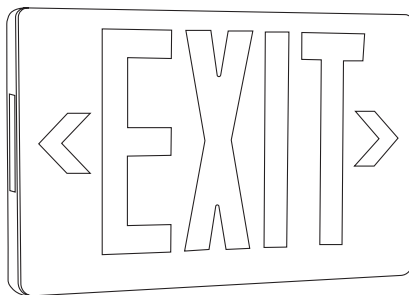

Let there be light!
(literally)

Components

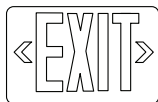

(a) x1

Exit Sign Housing + Panel



(b) x1

Canopy Mount

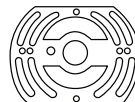

(c) x1

Trim Plate

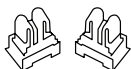

(d) x2

Support Connectors

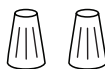

(e) x2

Wire Nuts



(f) x2

Mounting Screws

What You Need

Get Your Gear

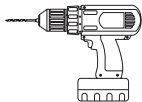

Drill



Pliers



Screwdriver



Ladder

IMPORTANT: Prior to exit sign installation, install junction box in ceiling or wall. When re-lamping, use only lamps specified in the exit sign. Using other lamp types may result in transformer damage or unsafe conditions. The battery in this unit may not be fully charged upon unboxing. After electricity is hooked up to the unit, let the battery charge for at least 24 hours. It is then ready for normal operation. Unused wires must be capped with a wire nut.

Before You Start

Safety Information (Not Included)

- Turn off circuit breaker before installing this fixture.
 - Suitable for use in damp environments at temperatures ranging from 32°F to 104°F. Not for use where directly exposed to water.
 - Not compatible with photo controls.
 - Not compatible with occupancy sensors.
 - Not compatible with 3rd party sensors.
 - Not compatible with dimmers.
- Not compatible with timing devices.
 - All electrical connections must be in accordance with local and National Electric Code (N.E.C.) standards.
 - Please review installation manual carefully before proceeding. Consult a qualified electrician if you are unfamiliar with proper electrical wiring connections.

⚠ WARNING:

Cancer & Reproductive Harm- www.P65Warnings.ca.gov

This device complies with Part 15 of the FCC rules. Operation is subject to the following two conditions:

1.) This device may not cause harmful interference.

2.) This device must accept any interference that may cause undesired operation. Please review all instructions carefully prior to installation.

Mounting Options

Ceiling Mount



End/Wall Mount



Installation Guide

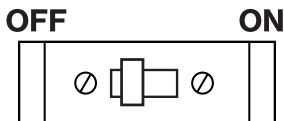

STEP 1

- Turn off circuit breaker before installation.
- Components are stored inside the exit sign.

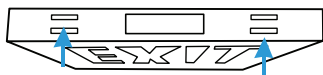

STEP 2

- Using a flathead screwdriver, insert into slots on top and pry open the housing of the front side exit sign. Unsnap and pull off faceplate and set aside.
- Mounting components are wrapped in plastic for convenience. Remove them and set aside.

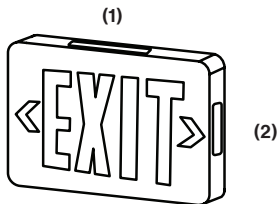

STEP 3

- Pop out top knockout for ceiling mount (1) or side knockout for wall mount (2).
 - Feed the wires through hole. Secure wires with wire guide.
- Optional: To install the exit sign with both front side and back side, unsnap the housing and pull off the backplate. Then, snap the second faceplate ensuring all four corners have snapped together properly.

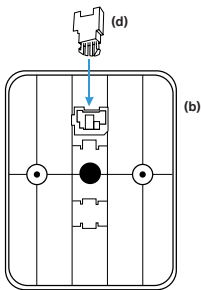

STEP 4

a. Remove canopy mount (b) and mounting hardware from plastic packaging.

b. Snap the two support connectors (d) into the canopy mount slots into the back of the canopy mount (b).

Note: This should not require a lot of force.

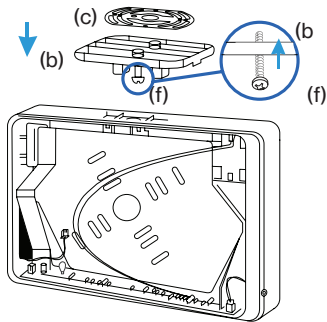

STEP 5

a. Snap the canopy mount (b) into the open slots of the exit sign based on the mounting option selected.

b. Align trim plate (c) to screw holes of canopy mount (b), then, screw the mounting screws (f) from the bottom side of the trim plate (c) to secure it.

c. Feed lead wires through canopy mount (b) and trim plate (c).

Note: Installation for ceiling and end/wall mount follow the same steps. The exit sign back plate housing also has knockout outlines to drill out (optional).

Installation Guide (Cont.)

STEP 6

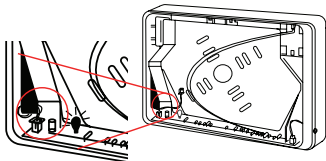

- Connect battery to the PC board by plugging wire into socket.
- Connect exit sign lead wires to AC input leads in junction box (not included) and cap off unused wires with wire nuts (e).
- Red to Black (Live) • White to White (Neutral)
- Feed excess wire into J-box.

STEP 7

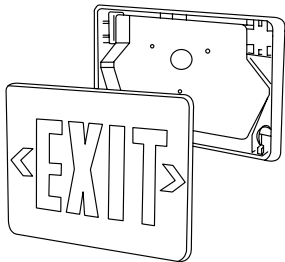

- Reattach faceplate. Ensure all four corners have snapped together properly.
- Knock out directional arrow(s), as appropriate for your light fixture location.
- Turn on power. Battery may need 24 hours to charge before light fixture is used for emergency purposes.

Product Details

Wiring Diagram

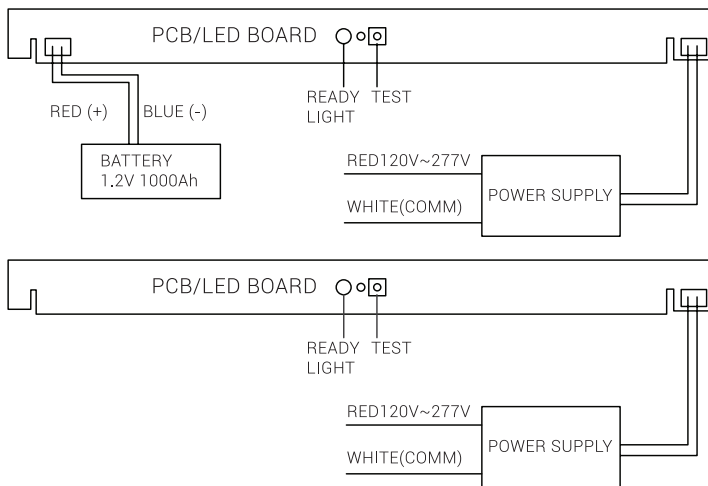

Specifications

Voltage	120V-277V	Average Lifetime	26280 Hours
Wattage	1.6W	Lumens	5LM
Power Factor	0.45	IP Rating	IP20
CRI	7	Battery	1.2V1000mah NI-MH
Weight	1.54 lbs	Power Source	Battery
Housing Material	ABS	Amps	20mA
Dimmable	No	Warranty	3 Years

Common Troubleshooting

Feeling in the dark about an issue with your product? No worries! Our troubleshooting section is here to shed some light and provide you with easy-to-follow solutions for any problem.

If you still need some assistance, please feel free to contact us with any questions. Our team of lighting experts are happy to help brighten your day.

Installation

Light isn't turning on.

Double check if fixture is properly connected and circuit breaker hasn't been tripped.

Light isn't bright enough.

Check proper wattage and for unobstructed fixture.

Battery

Light not lasting on a single charge.

Ensure the battery is properly connected and compatible.

Battery is not charged.

Verify the battery is securely plugged in and the supply wires are properly connected.

Test light is not working.

Ensure the battery is properly connected.

Flickering

Light is flickering when turning on.

Check that fixture wiring connections are secure.

Light flickering with other lights on the same circuit.

Check that the lights on the same circuit are not overloading the circuit.

Light flickering when turned on.

Verify fixture compatibility and that it is grounded.

Buzzing

Fixture buzzing with power outages.

Verify light is connected to surge protector securely.

Fixture buzzing with appliances or electronic devices.

Look for nearby interferences that can cause buzzing. Such as televisions, radios, computers, etc.

Sunco

Lighting made better.

support@sunco.com
(844) 334-9938

REV1.0

