

hello!

TIMMKOO Q3E

FULL SCREEN MP3&MP4 PLAYER



Key Diagram

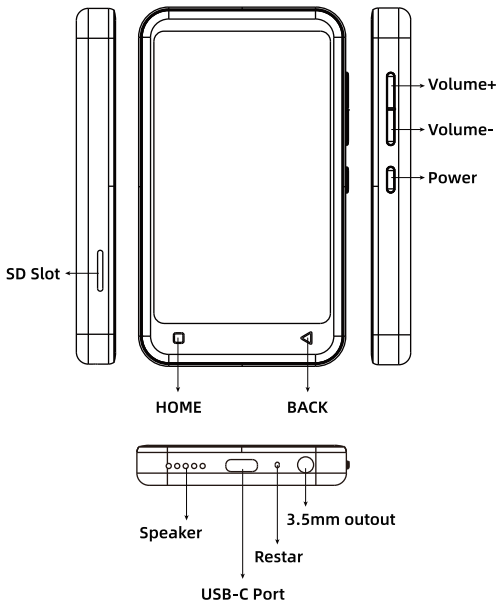

Button & Port Introduction

Power:

- In shutdown state, press and hold for 3 seconds to turn on.
- In power-on state, long press for 3 seconds to activate the shutdown options: Power off, Restart, Airplane mode.
- Short press to turn off / on the screen.

Volume + / - : Press + / - to turn up/down the volume.

USB-C: Connect type-c cable for charging and file transfer.

Restart: Long press for 3 seconds with the pin, the device will be reboot.

Back: Click to come back to the previous page.

Home: Click to come back to homepage. Long press to open the background process management (Recently used apps), swipe left/right to remove the selected process.

SD slot: Expand storage of the device, maximum support 512GB TF / Micro-SD card.

3.5mm output: Connect your headphones or external speakers as audio output.

How to Transfer Music or Video

1. Transfer from your computer:

► For Windows:

1) Use the included USB cable to connect the player to your computer. The computer will automatically recognize the device and install the driver. After the installation is successful, Click "My Computer", you will find an MTP device named "Q3E" in the list of devices and drives, click on it to access the player's internal/external SD card and its folders.

2) Copy the downloaded music or videos, e-books and other files from your computer and paste them into the folder here, just like using a normal USB flash drive.

► For MacOS:

1) Please download and install the MTP device file transfer software. The recommended software is as follows:

OpenMTP: <https://openmtp.ganeshrvel.com/>

MacDroid: <https://www.macdroid.app/>

2) Launch the installed OpenMTP or MacDroid software and follow the prompts to connect the player to the Mac device. You will find the device named "Q3E" (or "MX2") and all its folders in the device list of the software.

3) Copy the downloaded music, videos, e-books and other files from the Mac device and paste them into the target folder of the device "Q3E"(or "MX2").

How to Transfer Music or Video

2. Transfer from your phone:

► For Android:

Transfer music or videos from Android smartphone to the player requires the MiniShare app. Please scan the following QR code to download and install MiniShare



MiniShare for Android

① Android phone ⇒ Q3E Player

a) Click the "File transfer" icon on the desktop of the Q3E player to open the MiniShare

App. And click the ⇄ icon in the middle of the window to switch to Send/Receive mode, and then click the "Receive" icon, and the device will start hotspot and pop up a QR code for scanning.

b) Open the MiniShare app on Android phone, also click the ⇄ icon in the middle of the window to switch to Send/Receive mode, and click the "Send" icon, then select the music and videos to be transferred, and click the "Send" button that pops up below. Next, you can find the avatar and name of Q3E player in the search radar, click it to establish a connection and start transferring files (If you have set a hotspot password, you will be asked to enter it). If not found in the search radar, you can

How to Transfer Music or Video

also click the "Scan QR Code" button below to activate the camera scanning, and scan the QR code of Q3E player to establish a connection, and then start to transfer files.

② Android phone ↔ Q3E Player

a) Click the "File transfer" icon on the desktop of the Q3E player to open the MiniShare app. And click the  icon in the middle of the window to switch to Create Group/Join mode, and then click the "Create Group" icon, and the device will start hotspot and pop up a QR code for scanning.

b) Open the MiniShare app on Android phone, and also click the  icon in the middle of the window to switch to Create Group/Join mode, click the "Join Group" icon. Next, you can find the avatar and name of Q3E player in the search radar, click it to establish a connection and start transferring files (If you have set a hotspot password, you will be asked to enter it). If not found in the search radar, you can also click the "Scan QR Code" button below to activate the camera scanning, and scan the QR code of Q3E player to establish a connection, and then start to transfer files.

Tips: In the Create Group/Join Group mode, multiple devices are allowed to join the same group to transfer files between each other.

How to Transfer Music or Video

► For IOS:

Since IOS is a closed source system, the music stored on the iPhone cannot be transfer directly to the Q5 player. You must first export the music to your computer from your iPhone with iTunes or other third-party software (such as iTools), and then transfer to the Q5 player from your computer (please refer to the "transfer from your computer" section).

** The pictures and videos in the Photos App can be downloaded directly to the Q5 player. Please refer to the FAQ section in the "File Transfer" chapter*

Music

1. Know The Main Window of Music App

Click the Music app on the player's desktop to enter the main window. Here, there are 4 commonly used tabs for you to customize the function menu of the app, and manage songs and playlists. As below:

1)  Including User login, Function menu, Settings, etc.

▶ **Import Music Via WiFi:** (only applicable to models with WiFi) Import music in batches from your computer and cellphone via WiFi. The player and the sending device must be under the same wifi.

▶ **Music scan:** Scan music in all folders or specific folders. Different scanning rules can be selected.

▶ **Equalizer:** Enable or disable equalizer, you can choose Pop, Blues, Classic, Jazz, Rock, Dance, Metal, Voice, Custom, etc.

▶ **MSEB:** enable/disable MSEB sound adjustment.

▶ **Plugins:** Add playback plugins.

▶ **Sleep timer:** Set the sleep time from 0 to 120 minutes, and once the set time is exceeded, it will stop playing music.

▶ **Settings:** More setting options can be found here, such as Show lyric, Resume play from last position, Font size, Language, Album cover display, etc.

▶ **Quick guide:** Guide you to operate the App

▶ **Exit:** Close and exit the music App

Music

2) 🎵 Manage your songs according to different categories. For example:

▶ **Title:** Show all local songs, including the device internal storage and external SD card. And sort in alphabetical order by default.

▶ **Folder:** Show all local folders, including device internal storage and external SD card. You can quickly access the target folder and add songs to the playlist in batches.

** If you want to display only the folders containing music, you can enable the "Filter non-music files and folders" item in Music.*

▶ **Album:** Organize songs by album name

▶ **Artist:** Organize songs by artist name



▶ **Genre:** Organize songs by their genre type

▶ **Album Artist:** Organize songs by album+artist

3) ☰🎵 Manage all your lists, including:

▶ **Favourite:** List all songs marked as Favourite.

▶ **Recently:** List those recently played songs

▶ **Playlist:** List all playlists you have created. Here you can click  to create a new playlist, or click  to import a playlist.

4) 🔍 Quickly search for Tracks, Artists, Albums or Genres.





Moreover, there are more shortcut menus under each song category to meet your different

Music

operating needs. For example:







1)  **Shuffle all:** Click “Shuffle all” every time, it will refresh the shuffle sequence.

2) : Click this icon under Title or Folder to activate the selection mode, and then click the check box in front of target files one by one to select it. Next, you can do in the shortcut bar at the bottom:

-  Enqueue(next track) → Assign the currently selected song as the next track.
-  Add to playlist → Add the currently selected song to a specific playlist.
-  Send to → Unavailable
-  Delete → Delete the currently selected song











Note: To activate the selection mode under Album, Artist, Genre, Album Artist, long press any item under it.

3) Long press any item under Title or Folder, you can:

-  Enqueue (next track) → Assign the currently selected song as the next track.
-  Enqueue (last track) → Add the current song to the playback sequence.
-  Add to playlist → Add the current song to the playlist.
-  Properties → View the details of the current song
-  Delete track → Delete the current song
-  Show album info → View the info of the album where the song is located.
-  Send to → Unavailable



2. Know The Music Playing Window

Click the thumbnail bar at the bottom of the main window to access the music playing window. Here, you can view the album cover, lyrics, details (Samplerate, Bits, Bitrate, etc.), and control the playback process. The following are some commonly used keystrokes.

-  → Switch between the linear progress bar and the circular progress bar
-  → Shuffle all Click it to switch to List loop, Loop single, Sequential play.
-  → List loop
-  → Loop single
-  → Sequential play
-  → Click to switch to the next song
-  → Click to switch to the previous song
-  → Play/Pause
-  → View the playlist of the current song
-  → Enable shortcut menu: Add to playlist, Equalizer, Show album info, Properties, Obtain lyrics and cover art online

3.FAQ

1) How to create a playlist?

Click “  New playlist” in the “Playlist” of the list-tab , then enter the name you want, and click Ok.

2) How to add songs to the playlist?

▶ **Add single:** Long press the target track, and select "Add to playlist" in the pop-up menu, Next, Select an existing playlist or click “New Playlist” to create a new playlist for store.

▶ **Add in batch:** Click this icon  under Title or Folder to activate the selection mode, and then click the check box in front of target files one by one to select it. Next, Then select "Add to playlist" in the bottom toolbar.





3) How to view lyrics?

Swipe left in the middle of the playing window to switch between the album cover, lyrics page, and details page. Lyrics come from your local .lrc file. If .lrc is missing, you can also click the icon  in the upper right corner and select "Obtain lyrics and cover art online" to get.

Videos

1. Know the video management window

Click the Videos app on the player's desktop to enter the video management window. Here,

- 1) All folders with videos are displayed. Click to open any folder and you can see all the videos in that folder.
- 2) Click the icon  in the upper right corner, you can get more menu options to help you better manage video files.
 - ▶ **Search** → Search by the partial or complete video name and quickly locate the target video.
 - ▶ **View** → Select the view type and sorting method of the video management window, and what information fields are displayed.
 - ▶ **Select** → Activate the selection function to select folders or files and edit them, such as  Mark as,  Delete,  Rename, Share, Hide, etc.
 - ▶ **Settings** → Set various functions and parameters of videos App, such as style, decoding, audio, subtitles, etc. (It is not recommended to modify frequently)

2. Know the video playback window

Click the video you want to play in the video management window to enter the playback window. Here, there are many shortcut buttons for you to watch the video better.

 → Rotate the screen to portrait or landscape

 → Lock the operation on the window, all keys are invalid in this state. Click it again to restore.

SW → Choose the right decoder, such as HW decoder, SW decoder.





Videos

 → Choose the audio track you want, if available. If you select "Disable", there will be no sound when playing the video.

 → Click to switch to the next video; Long press, a pop-up menu will let you choose the playback mode: Loop one, Loop all, Shuffle.

 → Click to switch to the previous video.

 → Play/Pause

 → Switch the viewing size :  Fit to screen,  Stretch,  CROP,  100% full screen

In addition, click the icon  in the upper right corner, more menu options will give you more help.

▶ **Speed** → Select the "Speed" option in "Play" item to activate the speed adjustment bar, and you can speed up/slow down the playback speed by pressing the +/- keys.

▶ **Background play** → Check this option "Background play" in "Play" item, you can continue to operate other applications without exiting the video playback. To return to watching the video, please click the  icon in the lower right corner of the video management window.

▶ **Video** → Uncheck this option in "Display" item, the playback screen will be blocked, and only the audio track of the video will be played.

▶ **Screen Rotation** → Uncheck this option in "Display" item, the  icon will disappear and you will not be able to rotate the screen.

Videos

- ▶ **Video zoom** → Click this option, you can change the viewing size, the options are: Fit to screen, Stretch, Crop, 100%, Custom. You can also change the viewing size with GMD gesture control.
- ▶ **Subtitle** → This option allows you to open the downloaded subtitles or search for subtitles online.
- ▶ **Tools** → This option allows you to Share, Delete, and Rename the current video.

3. FAQ

1) How to fast forward or rewind?

- ① Press and hold in the playing window and drag the progress bar forward or backward to the target position.
- ② Click the target position you want to play on the progress bar.

2) Can I speed up or slow down the playing speed? How to do?

Yes, you can. Click the  icon in the upper right corner of the playing window to open the menu, and select "Play-Speed", and then use the + / - key in the pop-up speed adjustment bar to speed up or slow down the playback speed.

3) If shuts down unexpectedly during playing, after restarting, can the player continue to play from where it stopped last time?

Yes it can. The player has the feature of memorizing the playing position. When you come back again, the app will ask you to choose "START OVER" or "RESUME". Click "RESUME" to continue play from where it stopped last time.

4) My video has audio tracks in different languages, such as English, Portuguese, can I choose one of them to play.



Yes. There are several ways to choose or open your audio tracks:

- ① Click the 🎵 icon in the play window, and then select the target audio track in the pop-up window
- ② Click the ⋮ icon in the upper right corner of the playback window, and click "Audio ⇒ Audio track", and then select the target audio track in the pop-up window.
- ③ If your audio track is a separate file, you can also click "Audio ⇒ Open", then find its path and open it.

Gallery

1. Know the albums management window

Click the Gallery app on the player's desktop to enter the albums management window. Here,

- 1) All folders with photos are displayed. Click to open any folder and you can see all the photos in that folder.
- 2) The default view mode is "Albums". If the pictures are grouped by location or time, you can also click the icon ▼ in the menu bar at the top of the window to select the view mode of Locations or Times.
- 3) Click the ⋮ icon in the upper right corner, and click "Select album" to activate the selection menu bar. Then you can select multiple or all albums to share or delete them.
 - ▶ **Select one or more albums:** Click the album you want to select.
 - ▶ **Select all albums:** Click the ▼ icon at the top of the window, and then click the "Select all" option.
 - ▶ **Deselect:** Click the ✓ icon at the top of the window to deselect.
 - ▶ **Sharing:** After selecting the album, click  or  to share by MiniShare or Bluetooth.
 - ▶ **Delete:** After selecting the album, click the ⋮ icon, and then select "Delete".

2. Know the photos management window

Click an folder in the album management window to enter the photos management window. All photos in the folder are displayed here. In this window, you can do:

1) Select view: Click ▼ at the top of the window, you can choose "Filmstrip view" or "Grid view".

2) Slideshow: Click ⋮ in the upper right corner and click "Slideshow" in the pop-up menu to show the photos one by one.



3) Group by: Click ⋮ in the upper right corner and click "Group by", you can define photos as grouped by location or time.

4) Select item: Click ⋮ in the upper right corner and click "Select item" to activate the selection menu bar. Then you can select multiple or all photos and edit them.

▶ **Select one or more photos:** Click the photos you want to edit.

▶ **Select all photos:** Click the ▼ icon at the top of the window, and then click the "Select all".

▶ **Deselect:** Click the ✓ icon at the top of the window to deselect.



▶ **Sharing:** After selecting the photos, click  or  to share by MiniShare or Bluetooth.

▶ **Delete:** After selecting the photos, click the ⋮ icon, and then select "Delete".

▶ **Rotate:** After selecting the photos, click the ⋮ icon, and then select "Rotate left" or "Rotate right" to rotate the photos left or right in batch.

3. Edit Photo

Click to open a photo in the photos management window. You can share or edit it as needed.

- ▶ **Share:** Click  or  to share to your friends by MiniShare or Bluetooth.
- ▶ **Delete:** Click the  icon in the upper right corner, and then select "Delete" to delete the current photo.
- ▶ **Edit:** Click the  icon in the lower left corner, or select "Edit" in the upper right menu to open the edit window. Then you can modify the Style, Color Saturation, Shadow, Exposure, Contrast, Stretching, Mirroring, etc. of the current photo.
- ▶ **Rotate:** Select "Rotate left" or "Rotate right" in the upper right menu to rotate the current photos left or right.
- ▶ **Crop:** Select "Crop" in the upper right menu, then adjust the size of the crop box, click save to crop the current picture
- ▶ **Set as wallpaper:** Select "Set picture as" in the upper right menu to set the current photo as desktop wallpaper.
- ▶ **Details:** Select "Details" in the upper right menu to view information of the current picture, such as width, Height, Size, Path, Create time.

4. FAQ

1) How to zoom in and out of pictures?

The player provides GMD gesture control function, which allows image zooming through 2 finger gestures.

EBook

1. Know the main interface of Ebook

Click the Ebook app on the player desktop for the first time to enter the main interface, and a pop-up window will show the entrances of 5 modules :

















- ▶ **Recent list:** Manage the books you have read recently
- ▶ **My Shelf:** Manage your favorite books
- ▶ **My Files:** Manage your local and network folders
- ▶ **Net Library:** Manage your online library
- ▶ **Bookmarks:** Manage all Bookmarks, Note, Highlight, etc.

2. Know the page operation layout

Open a book through the Ebook app for the first time, it will ask you to choose a page operation layout you are used to. There are 11 options in total. It determines the trigger area corresponding to Page up, Page down, Options, Bookmarks on the page when reading. For example, click on the right side of the page to jump to the next page, or click on the middle of the page to pop up the options task bar.

3. About Options and Reader bar

In the page operation layout, the options function is usually located in the middle area of the page. So when reading, tap the middle of the page to quickly pop up the Reader bar. When the options is triggered for the first time, the app will pop up a window to let you customize the buttons of the reader bar. You can tick the items you need. Using reader bar, you can get a better reading experience.

-  **Screen Orientation:** Switch to horizontal / vertical screen display
-  **Day/Night mode:** Switch to Day theme / Night theme
-  **Speak:** Activate TTS voice reading (Need voice engine support)
-  **Autoscroll:** Activate automatic scrolling, and no need to turn pages manually
-  **Chapters:** Manage the chapters and bookmarks of the book, through which you can quickly click to access the target chapters or bookmarks.
-  **Bookmark:** Add the current page as a new bookmark.
-  **Brightness:** Adjust brightness and enable blue-light filter.
-  **Font Size:** Adjust font size.
-  **Search:** Search for text in the current book.
-  **Allow tilt device to turn page:** Turn on or off the function of turning pages by tilting the device.
-  **Visual Options:** Provide more text and page adjustment options, such as font, font size/color/style, background color, paragraph spacing, line spacing, etc.
-  **Control Options:** More options for page operation and screen control. Such as defining the action of clicking, sliding, long-pressing, etc.
-  **Miscellaneous:** More reading auxiliary settings, such as full screen mode, screen awake, automatic scrolling mode.
-  **Options:** More page adjustment and control options. It is equivalent to the shortcut button of the menu  in the upper right corner of the page.
-  **Shutdown:** Exit Ebook

4. FAQ

1. How to select text in the book to copy, annotate, highlight or add special processing?

In the reading page, long press the target text, the app will pop up an option window, you can do:

 → Add background color to selected text

 → Underline selected text

 → Add strikethrough to selected text

 → Add wavy-underline to selected text

- ▶ **Copy:** Copy selected text
- ▶ **Highlight:** Highlight selected text
- ▶ **Note:** Annotate selected text

Tips:

- ▶ You can change the range of the selected text by dragging the cursor.
- ▶ You can click on the color block to change the preset color.
- ▶ To cancel the above text processing, just click the  button in the column.

2. Can I quickly locate a chapter or page of the book?

Yes it is. You can do it in the following ways:

- 1) Click the Options area of the page to trigger the reader bar, and then drag the reading progress bar to the target position, or click <> to jump page by page or chapter by chapter.
- 2) Click the icon  of the Reader bar, and click to select the target chapter or bookmark (if available).

Recorder

1. Know the recorder app interface

Click the Recorder app on the player's desktop to enter its main operation interface. here, you can do:

- /|| → Start/pause recording
- → Stop recording. After clicking, you can choose "Discard" or "Save" the current recording.
- ▶/|| → Play/pause the current recording
- ☰ → Recording list, where the recordings are saved

Click the ☰ icon in the upper right corner, you can also:

- ▶ **Voice quality:** Select "voice quality", you can set it to "High" or "Standard".
- ▶ **Recording mode:** Select "Recording mode", you can set the use occasion for recording, such as Normal, Meeting, Lecture.

2. FAQ

1) How to delete/delete in batch recording files?

Click the ☰ icon to open the recording list, and long-press any recording to activate the check box, check the recording that needs to be deleted, and then click the 🗑 icon below.

1. Know the Clock app interface

Click the Clock app on the player's desktop to enter clock interface. Here, there are 4 clock-related modules.

Alarm clock

1) Add a new alarm:

Click the  icon at the bottom of the window, it will jump to the "HH" dial by default, move the hour hand on the dial to the target position with your finger and let go. Then it will automatically jump to the "MM" dial, move the minute hand to the target position in the same way and let go. and click "Done".

** Click the HH: MM field above the dial to return to readjustment*

2) Add label/Repeat date/Cesium for alarm clock

Click the  button under an alarm clock to expand the setting item:



- ▶ **Lable** → Click "Lable" and enter the label text, click "ok". It is usually used to indicate the purpose of alarm clock.
- ▶ **REPEAT** → Check the "REPEAT" option, and then click on the day of the week when the alarm does not need to be repeated.
- ▶ **CESIUM** → Click "CESIUM", then select the one you like in the pop-up ringtone library.
- ▶ **Enable / Delete alarm** → Click the  button on the right side of the alarm clock to enable/disable the alarm clock;

Clock

Click the  icon in the lower right corner of the alarm clock to delete the current alarm clock.

► **More alarm settings** → Click the  icon in the lower right corner of the window, and click “Settings”, you can define more basic parameters, such as alarm style, ringing duration, interval duration, volume, etc.

Global City Time Zone

Here, you can add time zones for multiple cities. Click the  icon at the bottom of the window, and then tick the city you want to display. You can find the target city by scrolling the screen or the search button .

Timer

1) Add a new timer

- a. Click the number in the numeral dial to set the timer time, and then click Start.
- b. Click the  button in the timer list to add and run multiple timers

2) Label a timer

Click on the icon  above a timer to add a label to the timer to explain the purpose of the timer.

3) Increase the duration of the timer

For a running timer, click the +1' button in the lower left corner to add 1 minute to it each time.

Clock

4) Stop or Resume timing

Click the STOP button on the timer to pause timing, and then click the START button to resume timing

5) Reset a timer



For the timer in the paused state, click the icon  in the lower corner to return to the initial state and restart the timer.

6) Delete timer

Click the icon  in the lower right corner of the timer to delete the current timer.

Stopwatch

In the stopwatch window, you can do:

- 1) Start / Stop stopwatch:** Click the "START" or "STOP" button in the dial
- 2) Record a point in time:** During running, each time you click the icon  in the lower left corner, a time point will be recorded.
- 3) Reset stopwatch:** Click the button  in the lower right corner of the stopped stopwatch to reset the stopwatch.

File transfer

1. Know the main interface of MiniShare

Click the "File transfer" icon on the player's desktop to run the MiniShare app. This app is mainly used for file transfer between mobile phone and Q3E player. On the main interface, you can see the following function icons.

⑧ Click the icon ⑧ in the upper left corner, you can do in the pop-up window:

1) Edit the device avatar: Click the icon ⑧, and click the "Modify" button, then select "Select from gallery". Find the target picture in the gallery and click it (If necessary, If necessary, you can adjust the size of the clipping box to select a part of the picture), and then click the SAVE button in the upper left corner.

2) Edit the device name: Click the default device name or ✎ on the right side of the avatar, enter new name and click OK.



**The personalized avatars and names allow you to better identify your device in the search radar.*

3) Name WIFI hotspot: Click the button ● on the right of "Name WiFi hotspot with nickname" under "Settings", you can switch the hotspot name from the default d2b68RGRkZGZk to your device's nickname to better identify your device.

4) Set connection password: Click the button ● on the right of "Set connection password" under "Settings", and enter the 8-character alphanumeric password, then click ok. This makes it necessary for others to enter the password when they want to connect to your device.





File transfer



5) Set default storage: Click the button > on the right of "Default Storage" under Settings, You can specify internal storage or external storage as the default storage for receiving files.

 Click the icon  in the upper right corner, you can get different menu options:

1) Connect to Zapy: Guide you how to connect to Android device/Apple device/PC/Windows device

2) Set WiFi Options: You can set the WiFi type used to establish the connection as WiFi Direct or WiFi Hotspot, and set a password for the hotspot. And you can also choose whether the WiFi channel is 5G or 2.4G

 /  Click the icon  or  in the middle of the window, you can switch the file transfer mode to Send/Receive (one-way) or Group.

 Click the " history" button, you can view all historical sending and receiving records.

File transfer

- 📁 Click the “📁 Local File” button, you can view the photos, videos, and music in the local folder. Here, you can also quickly share them with friends follow the steps below.
- 1) Click the check-box behind the file to select the photo/video/audio that needs to be shared.
 - 2) Then click the “Share” button at the bottom of the window, a QR code will pop up and create a Group named after the device name.
 - 3) Next, you have 2 ways to establish a connection to transfer files.
 - ▶ Scan QR code: For iPhone, please install and open ZapyGo app on your phone and scan the QR code. Then, click “Go to Settings” to jump to the WIFI settings of your iPhone, and set the currently connected WIFI to the hotspot of Q3E (If you have set a hotspot password, you will be asked to enter it). Then return to ZapyGo to start transfer; For Android phones, Please install and open MiniShare app on your phone and scan the QR code. The app will automatically start transferring files.
 - ▶ Join in Group: For Android phones, open MiniShare and click the icon to switch to Group mode, then select “Join Group”, you will find the group created by the Q3E player in the search radar, click it to join (If you have set a hotspot password, you will be asked to enter it) and start transfer.

2.FAQ

1. How to get MiniShare or ZapyGo App?

► For Android Cellphone

Please scan the following QR code to download and install MiniShare.



MiniShare for Android

► For iPhone

Please search for "ZapyGo" in the App store or scan the following QR code to download and install.



ZapyGo for iPhone

ZapyGo can only be used to transfer pictures and videos those in the Photos App, not to directly transfer music from iPhone.

File transfer

2. How to transfer files between cellphones and Q3E players?

► For Android:

Please refer to the "transfer from your phone" topic in the "How to transfer Music or Video" section.

► For IOS:

① iPhone⇒Q3E Player

a) Click the "File transfer" icon on the desktop of the Q3E player to open the MiniShare App. And click the ⇄ icon in the middle of the window to switch to Send/Receive mode, and then click the "Receive" icon, and the device will start hotspot and pop up a QR code for scanning.

b) Open the ZapyGo on iPhone, and also click the ⇄ icon in the middle of the window to switch to Send/Receive mode, click the "Send" icon, then select the photos or videos to be transferred, and click the "Send" button that pops up below. Next, click "Scan to connect now" in the pop-up window to activate the camera scanning function, and scan the QR code on Q3E player.

c) According to the pop-up prompt, Click "Go to Settings" to jump to the WIFI settings of your iPhone, and set the currently connected WIFI to the hotspot of Q3E (If you have set a hotspot password, you will be asked to enter it). Then return to ZapyGo, and the app will starts uploading files to the player.

File transfer

② iPhone ↔ Q3E Player

a) Click the "File transfer" icon on the desktop of the Q3E player to open the MiniShare App. And click the  icon in the middle of the window to switch to Create Group/Join mode, and then click the "Create Group" icon, and the device will start hotspot and pop up a QR code for scanning.

b) Open the ZapyGo on iPhone, and also click the  icon in the middle of the window to switch to Join mode, click the "Join" icon, Next, click "Scan to connect now" in the pop-up window to activate the camera scanning function, and scan the QR code on Q3E player.

c) According to the pop-up prompt, Click "Go to Settings" to jump to the WIFI settings of your iPhone, and set the currently connected WIFI to the hotspot of Q3E (If you have set a hotspot password, you will be asked to enter it). Then return to Zapy Go, The mutual connection is successfully established. In this way, you can either transfer files from iPhone to the player, or transfer files from the player to iPhone.

File Manager

In File Manager, you can directly access / manage internal storage and external SD card and all their folders and files. And you can:

 **Add new folder**

 **Search files**

Click the icon  in the lower right corner of the window, more menus you can choose.



1) Select file or folder

Click this option to activate the selection & editing window. Then you can do:



1. **Select 1 or more files and folders** → Click the file or folder you want to select

2. **Select all files and folders** → Click the icon  at the top of the window, and then click the "Select all" option.

3. **Share** → After selecting the files, click the icon  at the bottom of the window to share to your friends by MiniShare or Bluetooth.

4. **Copy and Paste** → After selecting the files and folders, click the icon  at the bottom of the window to copy files. Then find the folder you want to paste into, and click the icon .

5. **Delete** → After selecting the files and folders, click the icon  at the bottom of the window, and click "ok".

6. **Cut and Paste** → After selecting the files and folders, click the icon  at the bottom of the window to cut files. Then find the folder you want to paste into, and click the icon .

File Manager

7. **Rename** → Select a target file or folder, Click the icon  in the lower right corner and select "Rename" to edit the name of the file or folder.

8. **Cancel selection** → please click  in the upper left corner to exit the selection window.

2) Hide/Show hidden files

Select "Hide hidden files" option to hide or show hidden files.

3) Sort

Select "Sort" option to choose the sorting rules of folders and files.

Calendar

In the calendar window, you can:

1) Switch calendar view: Click the icon ▼ at the top of the window to switch the view to Day, Week, Month, Agenda.

2) Add New event: Click the icon ⋮ in the upper right corner, select “New event”, enter the event name, location, time period, reminder and other information, and then click the “Done” button. After the event is created, the date related to the event will be marked, so that you can check your itinerary in time.

3) Clear events: Click the icon ⋮ in the upper right corner, select “Clear events”, check the events you want to clear, and then click OK.

4) Search events: Click the icon ⋮ in the upper right corner, select “Search”, and enter the keyword of the event, then click 🔍.

WiFi

Click the "Settings" icon on the main interface of the device to enter the settings window:

- **Enable/Disable WiFi:** Click the ON/OFF switch on the right side of "WiFi" to enable or disable the WiFi function.
- **Establish Connection:** After enabling WiFi, the device will automatically search for available WiFi hotspots around and display them in the list below. Find and click the target WiFi name in the list to establish a connection (if it is encrypted, you may be asked to enter the WiFi access password) to access the Internet.
- **Disconnect WiFi:** Click the name of the connected WiFi, and click "Forget" in the pop-up window to disconnect the WiFi.
- **Refresh WiFi List:** Click the refresh button  in the lower left corner.
- **Add WiFi Hotspot Manually:** Click the **+** button below, and enter the Network SSID name and password and click "Save".

For more WiFi options, please click the icon  in the lower right corner.

Bluetooth

Click the "Settings" icon on the main interface of the device to enter the settings window.

•**Enable/Disable Bluetooth:** Click the ON/OFF switch on the right side of "Bluetooth" to enable or disable the Bluetooth function.

•**Pairing:** After enabling Bluetooth, the device will automatically search for available Bluetooth devices around and display them in the list below. Find and click the name of the target Bluetooth device in the list of available devices to pair.

Note: Please make sure that the headphones, speakers or other Bluetooth devices that need to be paired are waiting for pairing.

•**Disconnect:** Click the name of the paired device, and click "OK" in the pop-up window. The device is still in the paired list for you to reconnect at any time.

•**Unpair:** Click the icon  on the right side of the paired device, and select the "Unpair" option in the pop-up window. The device will disappear from the paired list. Here you can also rename the device.

•**Refresh The Devices List:** Click "SEARCH FOR DEVICES" below to search for available devices again.

For more Bluetooth options, please click the icon  in the lower right corner.

Settings

1. WiFi

Please refer to the "WiFi" chapter.

2. Bluetooth

Please refer to the "Bluetooth" chapter.

3. Sound

- ▶ Volumes → Set the volume of music, video and other media, set the volume of notifications, and alarms.
- ▶ Default notification sound → Set notification ringtone
- ▶ Touch sounds → Enable/disable touch screen sounds.
- ▶ Screen lock sound → Enable/disable touch screen sounds

4. Display

- ▶ **Wallpaper** → You can choose your favorite picture as the wallpaper from the Gallery, Live Wallpapers, Wallpapers
- ▶ **Brightness** → Set the brightness of the screen
- ▶ **Sleep** → Set when in the inactive state for how many minutes/second, the device will automatically sleep to save power
- ▶ **Font size** → Set the font size of the device, the options are :Small, Normal, Large, Extra Large

5. Storage

Display the remaining space and occupancy of the device's internal storage and external SD card.

Settings

6. Disable App

In order to meet the specific needs of some users, some apps that can be disabled are listed here.

Including Recorder, Ebook, Video.

After clicking the checkbox on the right to tick an APP, the icon of the App will disappear on the desktop. You will not be able to use it unless you uncheck it.

Tips: This setting does not delete the App from the device, it just disables it.

7. Language & Input

Set device language and keyboard and input method.

8. Factory data reset

Reset the device to factory settings.

9. Date & time

Set the date and time of the device, you can use time and time zone provided by the network or custom time. You can also set the date format and time format (12-hours / 24-hours).

How to sync time/time zone automatically by network.

a.Ensure your device connected to a working Wi-Fi.

b.Enter settings → Date & Time → Automatic date & time → Use network-provided time.

c.Enter settings → Date & Time → Select Automatic time zone.

10. Scheduled power on & off

Set the scheduled power on/off time and its repetition rules. Once set and enabled, the device will automatically turn on or off at the set time.

Common faults and Solutions

1. The player can't be charged.

In the off state, when the USB cable is connected for charging, the player usually will light up and display the brand logo and remaining battery.

Troubleshooting:

1) Check whether it is caused by poor contact.

In most cases, charging failure is caused by poor contact. You can repeatedly plug and unplug the USB cable to test whether the charging can be resumed. If it can be charged at a certain moment, it indicates that there is poor contact.

2) Check whether USB port is damaged.

Connect the player to a computer with an available USB port by using a proven USB cable. If the fault persists, it indicates USB port of the player has been damaged.

3) Check if the USB cable is damaged.

▶ You can replace a proven USB cable to connect the player to check whether it can be charged. If it can, it means that the previous cable has been damaged.

▶ You can also use the USB cable to try to charge other devices, such as cellphones, to check whether it can charge other devices. If not, it means also that the cable has been damaged.

If it is confirmed that both the USB cable and the charging port are normal, it can be determined that it is the fault of the player itself. Please contact after-sales support for replacement or refund.

Tips: If turned off and not used for a long time (more than 3 months or even longer), the player may not be able to turn on or be charged. This is usually an illusion caused by the device being in an over-discharge protection state, rather than a real failure. In this case, please make sure to charge it for at least 2 hours before trying to turn it on.

Common faults and Solutions

2. Nothing happens when the player is connected to computer with USB cable.

Usually, use a USB cable to connect the player to the computer, the top of the player will appear with the icon . And an MTP device named Q3E will appear in the device and drive list of your computer.

Troubleshooting:

1) Check whether it is caused by poor contact.

In most cases, such failure is caused by poor contact. You can repeatedly plug and unplug the USB cable to test whether the connection can be resumed.

2) Check whether the USB port is damaged

Connect the player to a computer with an available USB port by using a proven USB cable. If the fault persists, it means USB port of the player has been damaged

3) Check if the USB cable is damaged.

▶ You can replace a proven USB cable to connect the player to Check if the connection can be restored. If it can, it means that the previous cable has been damaged.

▶ You can also try to use the USB cable to connect other devices. If there is also no response, it means also that the USB cable has been damaged.

3. I want to delete some unnecessary apps, how to do it?

Long press the App you want to delete on the desktop and drag it to the trash icon  at the top of the window, and then confirm to delete. The Apps you can delete include: Recorder, Ebook, Video.

Common faults and Solutions

4. How to take screenshots?

Press and hold the volume down button + the power button at the same time for 2 seconds. You can find your screenshots in Pictures--Screenshots in the device storage.

Warning:

·Deleting the app is irreversible. Unless you reset the device to factory settings. Please be cautious.

·If you just don't want to use an app for the time being, you can disable it in "Settings--Disable App", instead of deleting it.

·Some Android built-in APPs cannot be delete or uninstall, such as Music, Gallery, Clock, Calendar, etc.

5. How to clear apps running in the background?

Long press the Home button of the device, and swipe right one by one in the pop-up application list to clear the program.

Specification

Bluetooth version: 4.2

Product Size: 4.2 x 2.4 x 0.5 inch

Weight: 3.7 oz

Screen Size: 4.0 inch

Battery Capacity: 1800mAh

Input: 5V=1A

Charging Time: 90 Minutes

Internal Memory: 1G RAM+8GB ROM

Music Playtime: 50 hours

Video Playtime: 10 hours

Expansion slot: Micro SD/TF Card (up to 512GB)

Music format: MP3, WAV, FLAC, APE, OGG, M4A, AAC, WMA, MP2,

Video format: AVI, MKV, MPG, MPEG, RM, RMVB, VOB, MOV, FLV, ASF, DAT, MP4, 3GP

Photos format: JPEG, BMP, GIF

Ebook format: EPUB, TXT, PDF, DOCX, FB2, MOBI

Recording format: 3Gpp

FM Receiving Frequency: 87.5 MHz ~ 108 MHz

Warning

- ▶ Do not leave the device in an environment where the temperature is too low or too high (below -10°C or above 50°C) for a long time. Extreme temperature environments will cause the device to deform and shorten the service life of the device;
- ▶ Do not use the equipment under thunderstorm weather;
- ▶ Do not place the device in the water for a long time;
- ▶ Do not expose the equipment to the sun for a long time.

Warranty

Thank you for purchasing our products. You will enjoy the following services when using this product.

Warranty period: Within one year from the date of sale.

Warranty scope: Limited to the product host.

Warranty terms:

①. Within 1 year after purchase, failure or damage caused by product quality problems can be replaced for free or full refund.

②. Accessories are not included in the warranty, such as usb cable, earphones, etc., but if quality problems occur within 7 days after purchase, they can be replaced for free.

③. The following conditions are not covered by the warranty

- ▶ Out of the warranty period.
- ▶ It has been disassembled or repaired privately by the customer.
- ▶ Man-made damage, accidental damage or deformation.
- ▶ Failure caused by installation and use in abnormal environments such as high temperature, high pressure, and humidity..
- ▶ Damage caused by natural disasters such as lightning strikes, floods, and earthquakes.

Contact us

Email: estron@szestron.com

Online support:

<https://www.facebook.com/EstronCSS/>



We promise to reply you as soon as possible within 24 hours.

Thanks