

# Owner's Manual and Installation Instructions

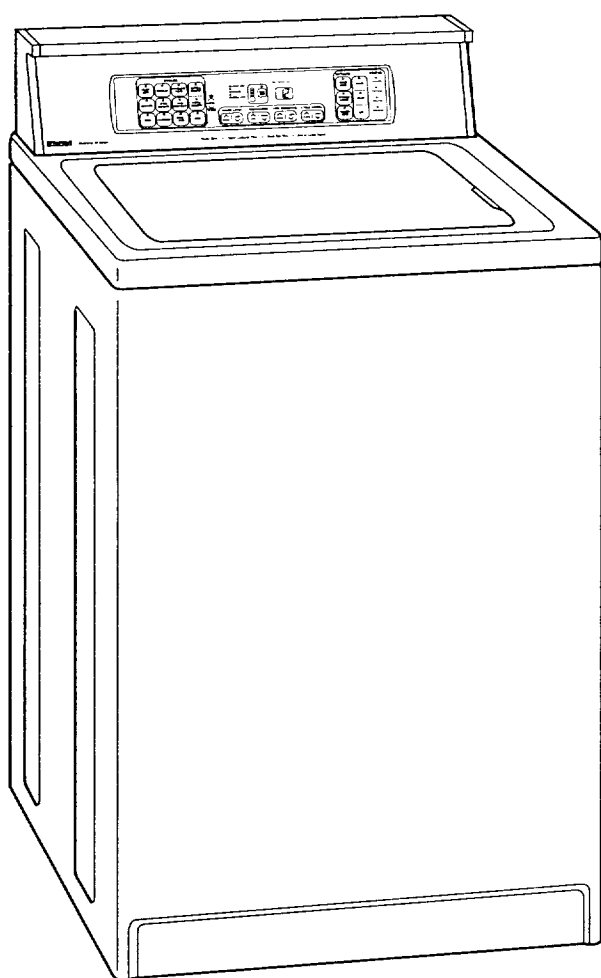

## Electronic Three-Speed AUTOMATIC WASHERS



**IMPORTANT:**  
Read and follow all safety  
and operating instructions  
before first use of this product.

Your washer may look different  
from the washer shown.

Sears, Roebuck and Co., Hoffman Estates, IL 60179 U.S.A.

PART NO. 3950148 Rev. A PRINTED IN U.S.A.

WARRANTY/SAFETY

INSTALLATION

OPERATION

LAUNDRY TIPS

MAINTENANCE

TROUBLESHOOTING

SERVICE

ESPAÑOL

## TABLE OF CONTENTS

BEFORE USING YOUR NEW WASHER	2
SEARS AUTOMATIC WASHER WARRANTY	3
IMPORTANT SAFETY INSTRUCTIONS	4
INSTALLATION INSTRUCTIONS	5
OPERATING YOUR WASHER	20
LAUNDRY TIPS	37
CARING FOR YOUR WASHER	39
TROUBLESHOOTING	41
SEARS MAINTENANCE AGREEMENT	46

## BEFORE USING YOUR NEW WASHER

Please read this manual. It will help you install and operate your new Kenmore washer in the safest and most economical way.

For more information about the care and operation of Kenmore appliances call your nearest Sears store. You will need the complete model and serial numbers when requesting information. Your washer's model and serial numbers are located on the Model and Serial Number Plate.

Use the space below to record the model number and serial number of your new Kenmore Washer.

Model No. \_\_\_\_\_

Serial No. \_\_\_\_\_

Date of Purchase \_\_\_\_\_

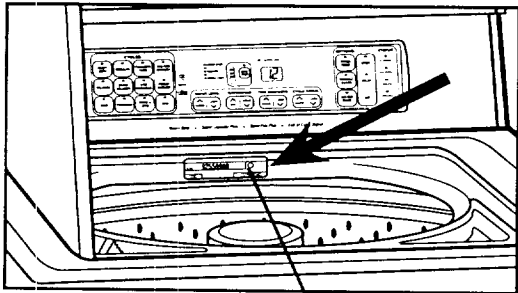

Model and Serial Number Plate

Keep this book and your Sears Salescheck (receipt) in a safe place for future reference.

# SEARS AUTOMATIC WASHER WARRANTY

WARRANTY/SAFETY

## FULL 1-YEAR WARRANTY ON MECHANICAL AND ELECTRICAL PARTS

For one year from the date of purchase, when the washer is installed and operated in accordance with the instructions in the Owner's Manual, Sears will repair or replace any mechanical or electrical parts in this washer, if defective in material or workmanship.

## LIMITED 5-YEAR WARRANTY ON GEARCASE PARTS

After one year and until five years from the date of purchase, Sears will furnish replacement parts for any defective gearcase parts. You will be charged for labor.

## LIMITED 10-YEAR WARRANTY ON PLASTIC TUB

After one year and until ten years from date of purchase, Sears will furnish a replacement plastic tub for any plastic tub which is defective in material or workmanship. You will be charged for labor.

If the washer is subjected to other than private family use, the above warranty coverage is effective for only 90 days.

WARRANTY SERVICE IS AVAILABLE BY CONTACTING THE NEAREST SEARS SERVICE CENTER IN THE UNITED STATES.

This warranty applies only while this product is in use in the United States. This warranty gives you specific legal rights, and you may also have other rights which vary from state to state.

Sears, Roebuck and Co., Dept. 817WA,  
Hoffman Estates, IL 60179.

**Your safety and the safety of others is very important.**

We have provided many important safety messages in this manual and on your appliance. Always read and obey all safety messages.



This is the safety alert symbol. This symbol alerts you to hazards that can kill or hurt you and others. All safety messages will be preceded by the safety alert symbol and the word "DANGER" or "WARNING." These words mean:

**⚠ DANGER**

You will be killed or seriously injured if you don't follow instructions.

**⚠ WARNING**

You can be killed or seriously injured if you don't follow instructions.

All safety messages will identify the hazard, tell you how to reduce the chance of injury, and tell you what can happen if the instructions are not followed.

## IMPORTANT SAFETY INSTRUCTIONS

### YOUR SAFETY IS IMPORTANT TO US.

**WARNING:** To reduce the risk of fire, electric shock, or injury to persons when using your washer, follow basic precautions, including the following:

- Read all instructions before using the washer.
- Do not wash articles that have been previously cleaned in, washed in, soaked in, or spotted with gasoline, dry-cleaning solvents, other flammable or explosive substances as they give off vapors that could ignite or explode.
- Do not add gasoline, dry-cleaning solvents, or other flammable or explosive substances to the wash water. These substances give off vapors that could ignite or explode.
- Under certain conditions, hydrogen gas may be produced in a hot water system that has not been used for 2 weeks or more. **HYDROGEN GAS IS EXPLOSIVE.** If the hot water system has not been used for such a period, before using a washing machine, turn on all hot water faucets and let the water flow from each for several minutes. This will release any accumulated hydrogen gas. As the gas is flammable, do not smoke or use an open flame during this time.

- Do not allow children to play on or in the washer. Close supervision of children is necessary when the washer is used near children.
- Before the washer is removed from service or discarded, remove the lid.
- Do not reach into the washer if the tub or agitator is moving.
- Do not install or store this washer where it will be exposed to the weather.
- Do not tamper with controls.
- Do not repair or replace any part of the washer or attempt any servicing unless specifically recommended in the Owner's Manual or in published user-repair instructions that you understand and have the skills to carry out.

### SAVE THESE INSTRUCTIONS

**IMPORTANT:** Observe all governing codes and ordinances.

# INSTALLATION INSTRUCTIONS

## INSTALLATION OVERVIEW

For a complete list of tools and parts needed, see pages 6-8.

### A. SELECT LOCATION FOR YOUR WASHER (pgs. 10-12) Recessed Area/ Closet Installation Instructions (p. 10)

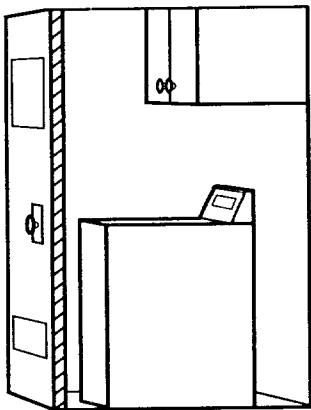

### Laundry Tub Drain System (p. 11)

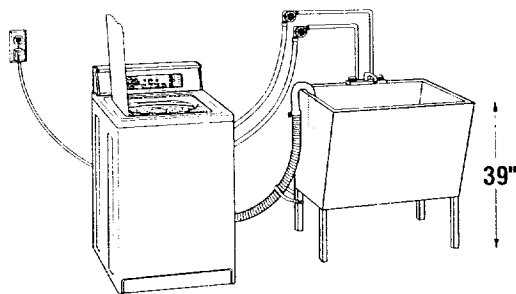

### Standpipe Drain System (p. 12)

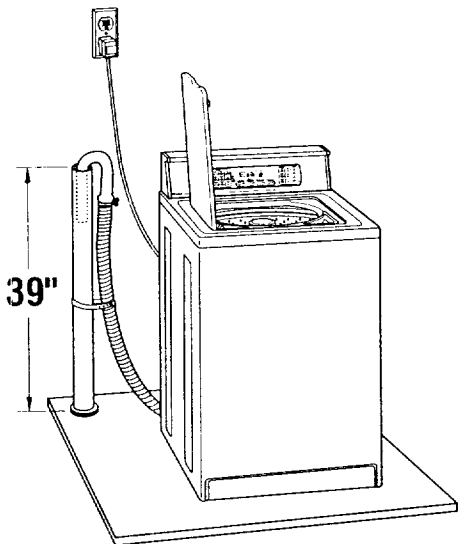

### Floor Drain System (p. 12)

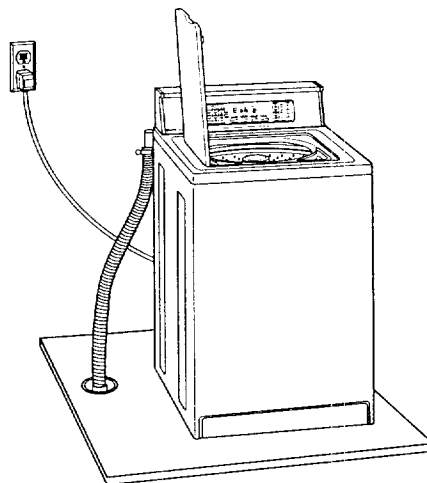

INSTALLATION

**B. REMOVE SHIPPING STRAP (p. 13)**

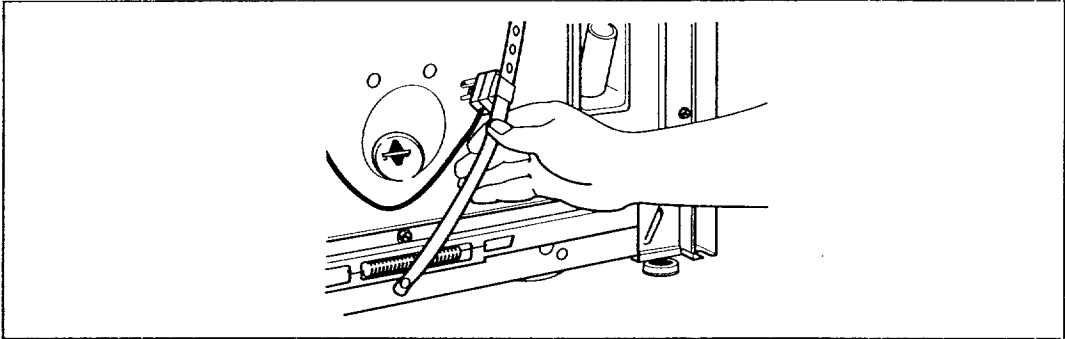

**Tools Needed:**

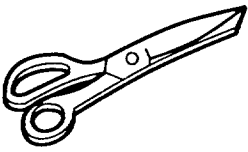

Scissors

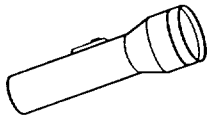

Flashlight (optional depending on installation)

**C. CONNECT DRAIN HOSE (pgs. 14-15)**

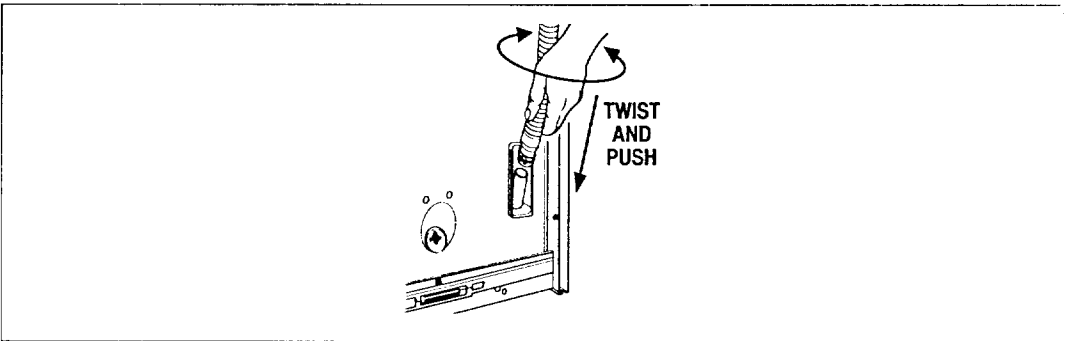

**Tools Needed:**

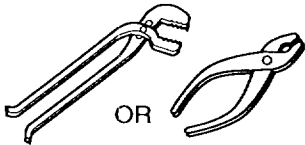

Pliers that open to 1<sup>9</sup>/<sub>16</sub> inches

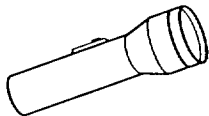

Flashlight (optional depending on installation)

**Parts Needed:**

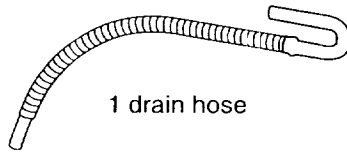

1 drain hose

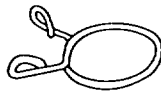

1 yellow, single-wire hose clamp (top of drain hose)

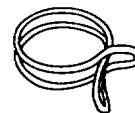

1 silver, double-wire hose clamp (bottom of drain hose)

**D. CONNECT INLET HOSES TO WATER FAUCETS (pgs. 15-16)**

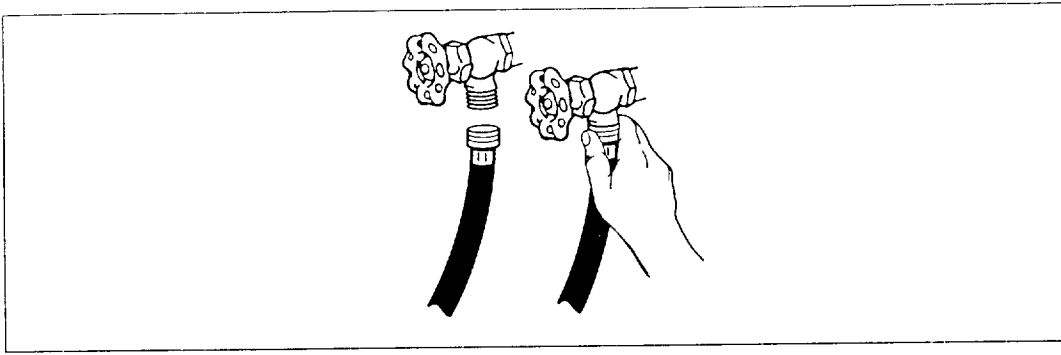

**INSTALLATION**

**Tools Needed:**

**Parts Needed:**

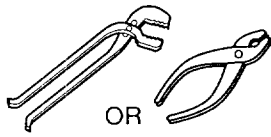

OR

Pliers that open to  $1\frac{9}{16}$  inches



2 flat water inlet hose washers

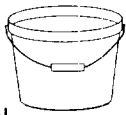

Bucket  
(optional  
depending on  
installation)

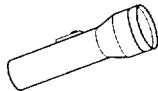

Flashlight (optional  
depending on  
installation)

**E. SECURE DRAIN HOSE (p. 17)**

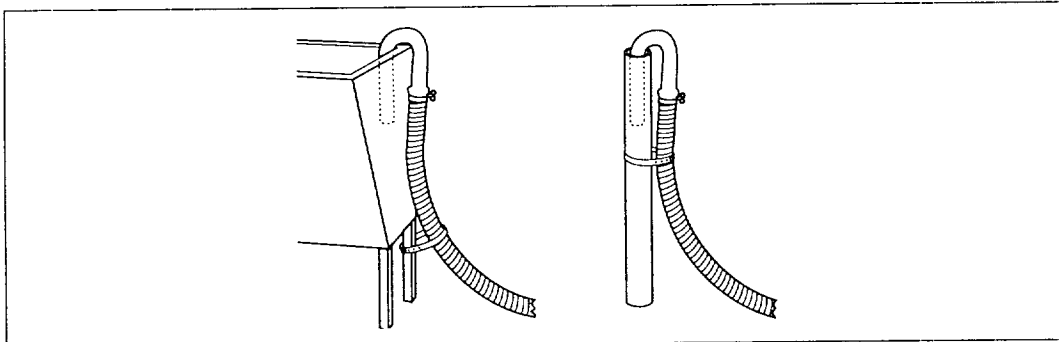

**Tools Needed:**

**Parts Needed:**

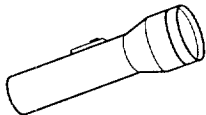

Flashlight (optional  
depending on installation)

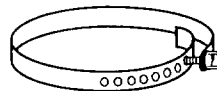

Shipping strap with fastener

**F. LEVEL WASHER (p. 18)**

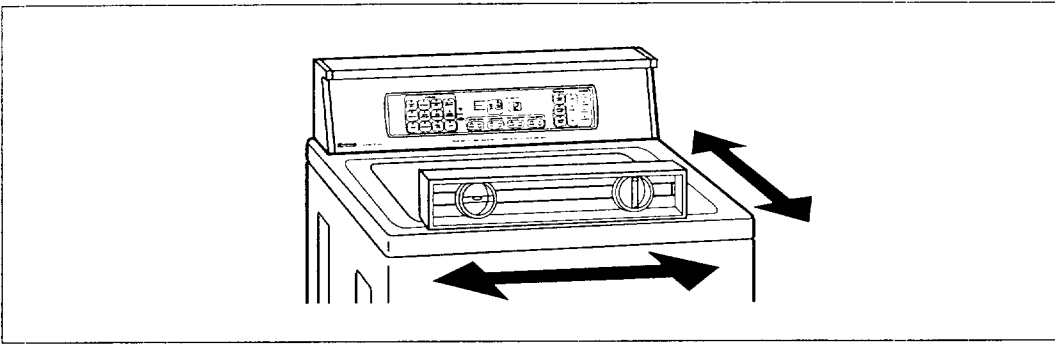

**Tools Needed:**

**Parts Needed:**

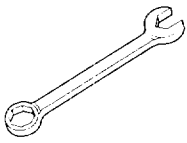

9/16-Inch  
open-end wrench

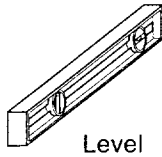

Level

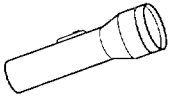

Flashlight (optional  
depending on installation)

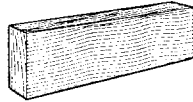

Wood block

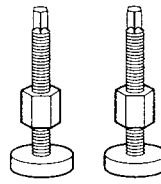

2 front leveling legs with nuts

## for your **Benefit**

Selecting the proper location for your washer will improve its performance and minimize concerns like washer walk or noise.

### ELECTRICAL REQUIREMENTS

120-Volt, 60-Hz., AC-only, 15- or 20-ampere fused electrical supply is required. (Time-delay fuse or circuit breaker is recommended.) Connect to individual branch circuit.

## **! WARNING**



### Electrical Shock Hazard

Plug into a grounded 3-prong outlet.  
Do not remove ground prong.  
Do not use an adapter.  
Do not use an extension cord.  
Failure to follow these instructions can result in death, fire, or electrical shock.

### GROUNDING INSTRUCTIONS

**WARNING:** Improper connection of the equipment grounding conductor can result in a risk of electric shock. Check with a qualified electrician or serviceman if you are in doubt as to whether the appliance is properly grounded. Do not modify the plug provided with the appliance – if it will not fit the outlet, have a proper outlet installed by a qualified electrician.

For your personal safety, this washer must be grounded. In the event of malfunction or breakdown, grounding will reduce the risk of electric shock by providing a path of least resistance for electric current.

This washer is equipped with a power supply cord having a 3-prong grounding plug. To minimize possible shock hazard, you must plug the power supply cord into a mating 3-prong grounding-type wall receptacle, grounded in accordance with National Electrical Code, ANSI/NFPA 70-latest edition and all local codes and ordinances.

**INSTALLATION**

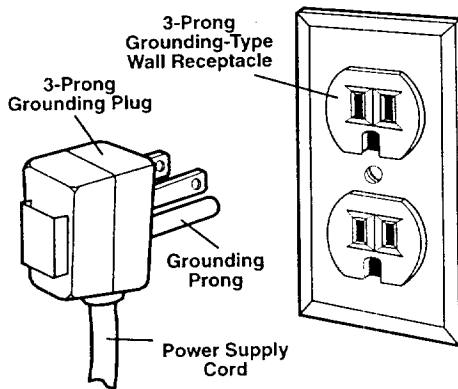

## A. SELECT LOCATION FOR YOUR WASHER –

### RECESSED AREA/ CLOSET INSTALLATION INSTRUCTIONS

This washer may be installed in a recessed area or closet.

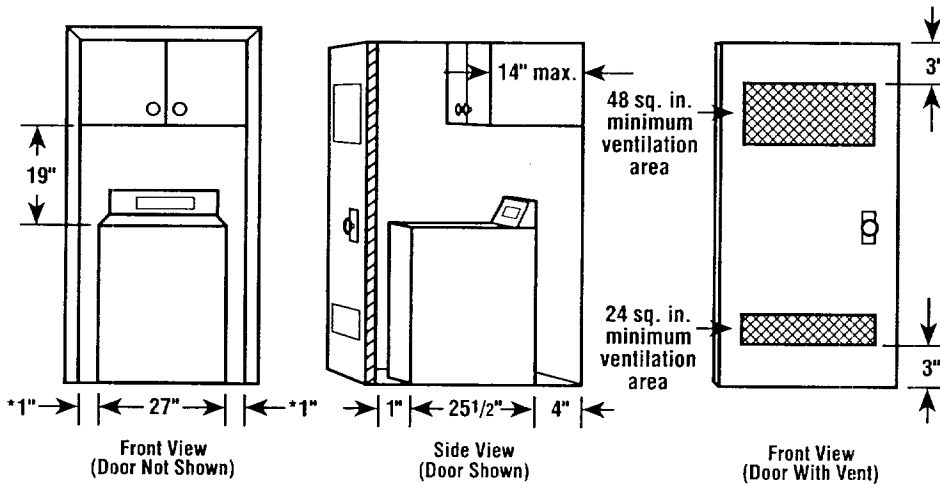

\*Additional clearance for wall, door and floor moldings may be required.  
To reduce transfer of washer sounds, a clearance of 1 inch on the sides of the washer is recommended.

- The installation spacing is in inches and is the minimum allowable.
- Allow additional space if other appliances are to be installed in the area.
- If closet door is installed, the minimum air openings in top and bottom are required. Louvered doors with equivalent air openings in top and bottom are acceptable.

## LAUNDRY TUB DRAIN SYSTEM

Check location where washer will be installed. This washer can be installed using one of three systems:

- Laundry tub drain system (below)
- Standpipe drain system (p. 12)
- Floor drain system (p. 12)

Do not store or operate washer at or below 32°F (some water may remain in washer). See page 40 for Winterizing Information.

Proper installation is your responsibility. Make sure you have everything necessary for correct installation including the following points:

INSTALLATION

**Grounded receptacle:** Must be within 4 feet of where the power cord is attached to the back of the washer.

**Hot and cold water faucets:** Must provide water pressure between 20-100 psi and be within 4 feet of the hot and cold water fill valves attached to the back of the washer.

**Laundry tub drain system:** Needs a minimum 20-gallon laundry tub.

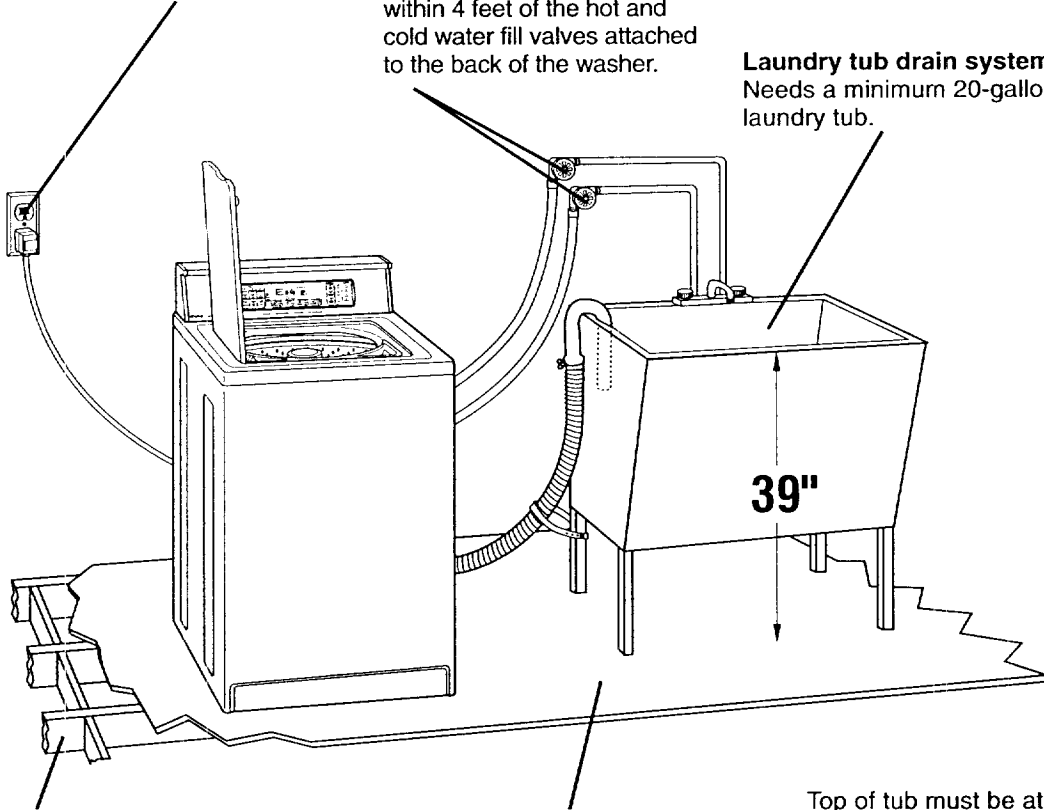

**Support:** Floor must be sturdy enough to support a total weight of 315 pounds (including washer, water, and load weight).

**Level floor:** Maximum allowable slope under entire washer – 1 inch.

Top of tub must be at least 39 inches above floor and no higher than 96 inches from bottom of washer.

**ALTERNATE LOCATIONS –  
STANDPIPE AND FLOOR DRAIN SYSTEMS**

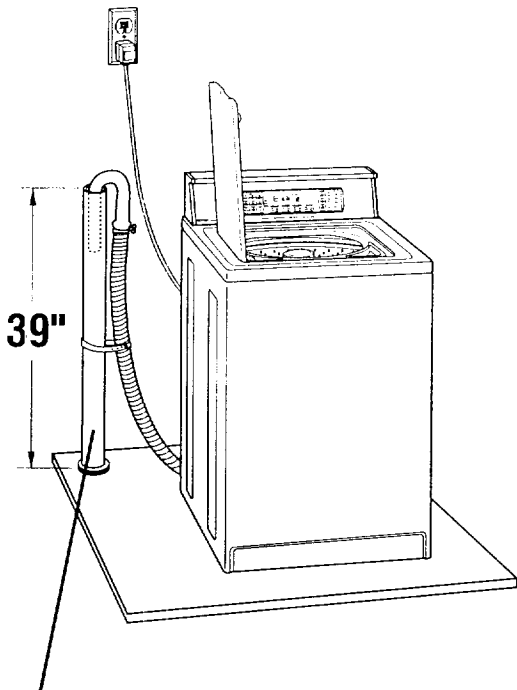

**Standpipe drain system:** Needs a two-inch minimum diameter standpipe with minimum carry-away capacity of 17 gallons per minute. Top of standpipe must be at least 39 inches above floor and no higher than 96 inches from bottom of washer.

**Siphon break:** Must be purchased separately. See chart below.

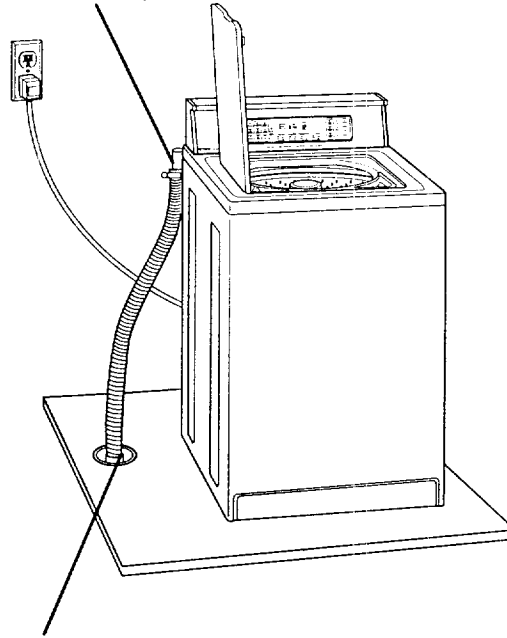

**Floor drain system:** Requires a siphon break, see chart below. A minimum carry-away capacity of 17 gallons per minute is required.

<b>If you have:</b>	<b>You will need to buy:</b>
Laundry tub or standpipe taller than 96 inches	Sump pump system (if not already available)
1-inch diameter standpipe	2-inch diameter to 1-inch diameter standpipe adapter, Part No. 3363920
Overhead sewer	Standard 20 gallon, 39-inch tall drain tub or utility sink and sump pump (available from local plumbing suppliers)
Floor drain	Siphon break, Part No. 285320; additional drain hose, Part No. 3357090; and Connector Kit, Part No. 285442

Parts listed are available from your local Sears store or Sears Service Center. Call 1-800-366-PART (1-800-366-7278).

## B. REMOVE SHIPPING STRAP

### for your Benefit

Removing the shipping strap is necessary for smooth operation. If the shipping strap is not removed, the washer will make excessive noise.

To prevent floor damage, set washer onto cardboard before moving across floor. Move washer close to its final location.

**STEP 1.** Read, then remove the label over the electrical plug and shipping strap.

**STEP 2.** Pull the yellow shipping strap completely out of the washer. There should be three cotter pins on the end of the shipping strap when it is pulled out of the washer. The electrical plug is attached to this shipping strap.

**STEP 3.** Pull firmly to remove the other end of the shipping strap pinned to the back of washer. This will release the rear self-leveling legs.

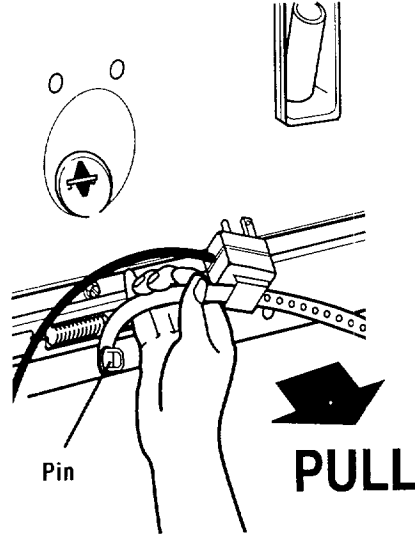

INSTALLATION

Electrical plug

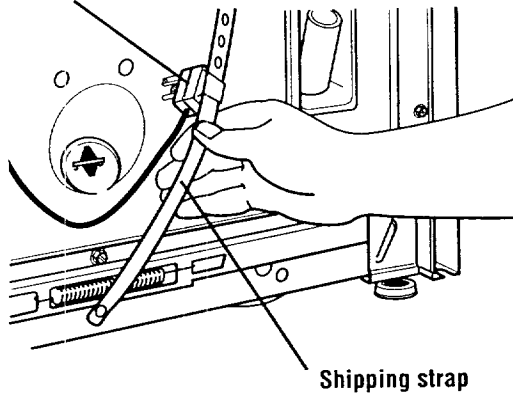

**STEP 4.** Cut the shipping strap about 16 inches from plug end. Look for the words "CUT HERE." Discard end with three cotter pins. Slide remainder of shipping strap free from the electrical plug. You will use this to secure the drain hose.

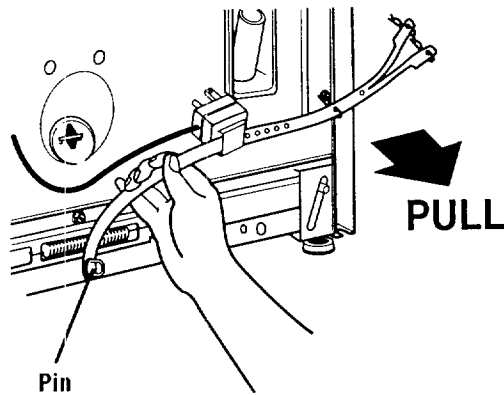
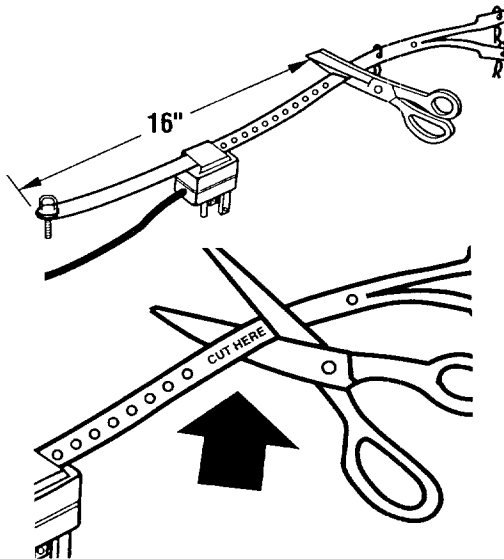

## C. CONNECT DRAIN HOSE

### **for your Benefit**

Proper connection of the drain hose will protect your floors from damage due to water leakage.

**STEP 1.** To prevent the drain hose from coming off or leaking, it must be installed per the following instructions:

**IMPORTANT:** To ensure proper installation, this procedure must be followed exactly.

- Wet the inside of the straight end of the drain hose with tap water. **DO NOT USE ANY OTHER LUBRICANT.**
- Squeeze ears of silver, double-wire clamp with pliers to open. Place clamp over the straight end of the drain hose  $\frac{1}{4}$  inch from the end.

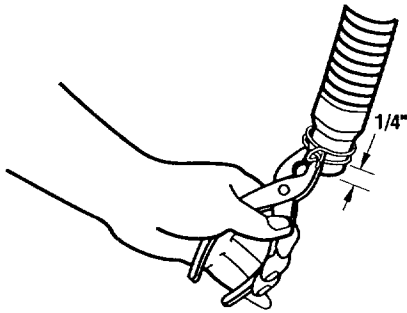

- Open clamp. Twist hose back and forth while pushing down onto drain connector at the bottom of the washer. Continue until hose contacts the ribbed stop on the cabinet.

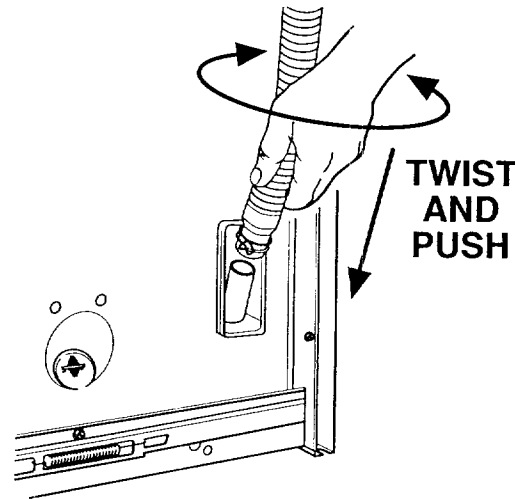

- Place clamp over area marked "CLAMP." Release clamp.

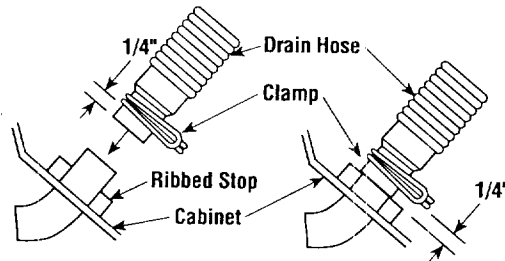

If you have:	You will need to buy:
Drain hose that is too short	Drain hose, Part No. 388423 and hose kit, Part No. 285442
Drain hose that is too long	Hose kit, Part No. 285442
A problem with lint clogging your drain	Drain protector, Part No. 367031

Parts listed are available from your local Sears store or Sears Service Center. Call 1-800-366-PART (1-800-366-7278).

For standpipe or laundry tub drain systems:

**STEP 2.** Open yellow, single-wire clamp with pliers and slide over hooked end of drain hose to secure the rubber and corrugated sections together.

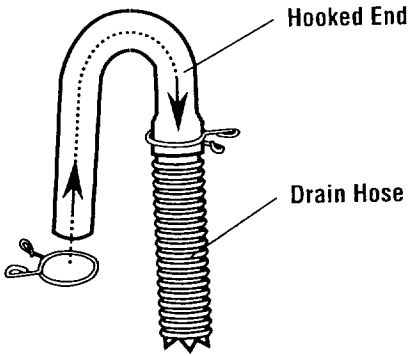

**STEP 3.** Put hooked end of drain hose into laundry tub or standpipe. Check for proper length of drain hose. Rotate hook to eliminate kinks.

To prevent drain water from going back into the washer:

- Do not straighten hooked end of drain hose and force excess drain hose into standpipe.
- Do not lay excess drain hose in bottom of laundry tub.

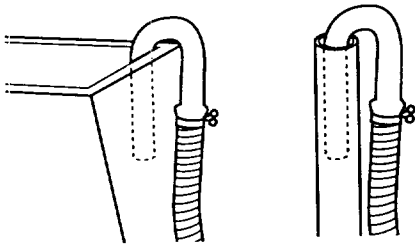

## D. CONNECT INLET HOSES TO WATER FAUCETS

### for your Benefit

Proper connection of your inlet hoses will allow hot and cold water to enter your washer properly. It also helps prevent water damage due to leaks.

### ! WARNING



**Slip and Fall Hazard**  
Use new water inlet hoses.  
Failure to do so can result in head injury or broken bones.

**NOTE:** Replace inlet hoses after five years of use to reduce the risk of hose failure. Periodically inspect and replace inlet hoses if bulges, kinks, cuts, wear, or leaks are found. When replacing your inlet hoses, mark the date of replacement on the label with a permanent marker.

**STEP 1.** Make sure washer basket is empty. Run water through both faucets into a bucket or laundry tub to get rid of particles in the water lines that might clog hoses. Determine which faucet is hot and which is cold. Mark the hot water faucet.

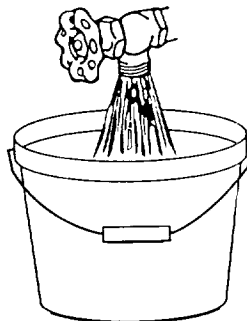

INSTALLATION

**STEP 2.** Remove water inlet hoses from washer by pulling upward with a hand-over-hand motion. Do not unscrew the hoses from their connections.

- If the hoses become hard to pull, give a sharp tug to break the hoses free from the water inlet hose shipping holder.
- If the yellow plastic water inlet hose shipping holder comes out on the end of the hoses, simply remove it and throw it away.
- If the hoses feel like they are caught inside the washer and a sharp tug does not free them, feed some hose length back into the washer and then begin pulling them out again.

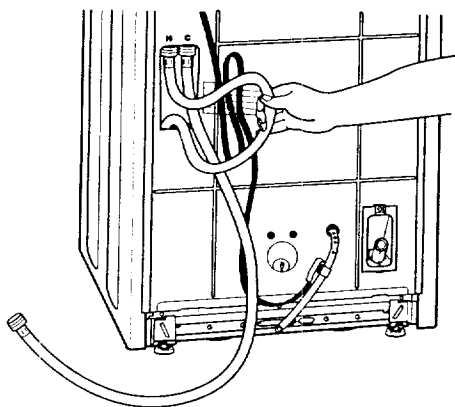

**STEP 3.** Insert one new, flat washer (from the parts bag) into each end of the inlet hoses. Check that washers are firmly seated in couplings.

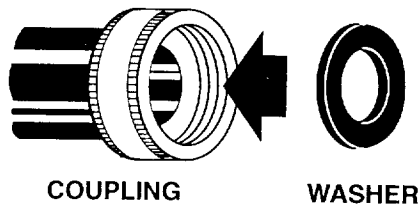

**STEP 4.** Attach the hose with the red coupling to the hot water faucet. Screw on coupling by hand. Make an additional two-thirds turn with pliers to tighten coupling. **DO NOT OVERTIGHTEN;** this could damage the coupling.

**STEP 5.** Attach the hose with the blue coupling to the cold water faucet. Screw on coupling to faucet by hand. Make an additional two-thirds turn with pliers to tighten coupling. **DO NOT OVERTIGHTEN;** this could damage the coupling.

**STEP 6.** Turn on water faucets and check for leaks. A small amount of water may enter the washer. You will drain this later.

If you have:	You will need to buy:
Water faucets beyond the reach of water fill hoses	2 longer water fill hoses: 6 ft. hoses, Part No. 76314 or 10 ft. hoses, Part No. 350008

Parts listed are available from your local Sears store or Sears Service Center. Call 1-800-366-PART (1-800-366-7278).

## E. SECURE DRAIN HOSE

### *for your* **Benefit**

Securing the drain hose properly will protect your floors from damage due to water leakage.

**STEP 1.** Move washer to its final location.

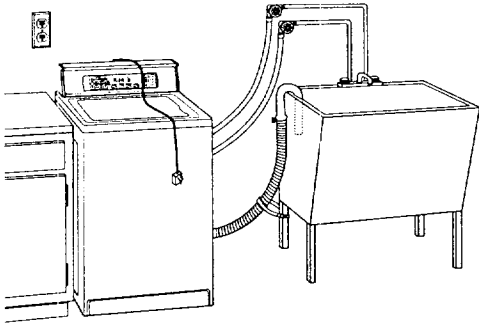

**STEP 2.** Locate the remaining piece of shipping strap (not the end with the three cotter pins) from STEP 4 of "REMOVE SHIPPING STRAP." Use it to wrap the drain hose together with the laundry tub or standpipe. Push fastener into the nearest hole in the shipping strap.

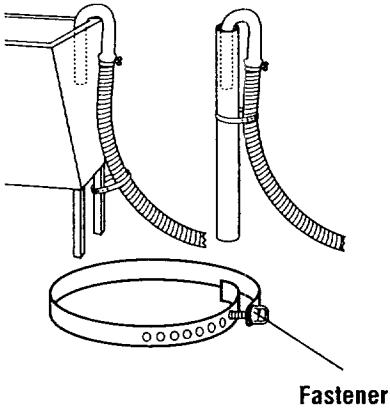

If the water faucets and drain standpipe are recessed, put hooked end of drain hose in standpipe. Tightly wrap the shipping strap around the drain hose and water inlet hoses (not the handles or stems). Push fastener into the nearest hole in the shipping strap.

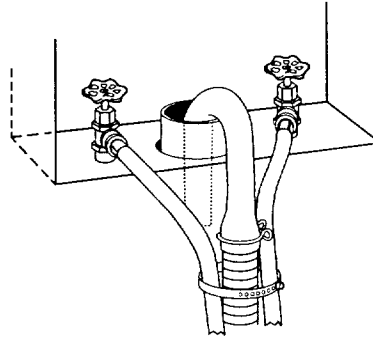

**INSTALLATION**

© 2009 Whirlpool Corporation

## F. LEVEL WASHER

### *for your* **Benefit**

Leveling your washer properly prevents excessive noise and vibration.

To install front legs:

**STEP 1.** Prop front of washer up (about 4 inches). Use a wood block or another object that will support the weight of the washer. If washer was placed against a wall, move the washer out slightly before tipping it up.

**STEP 2.** With one of the legs in hand, screw lock nut onto leg  $\frac{3}{8}$  inch from top of leg base. This is the recommended initial setting.

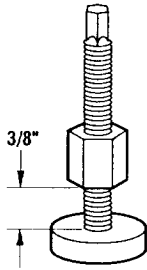

**STEP 3.** Screw leg into washer base by hand until nut reaches washer base. Repeat for other leg.

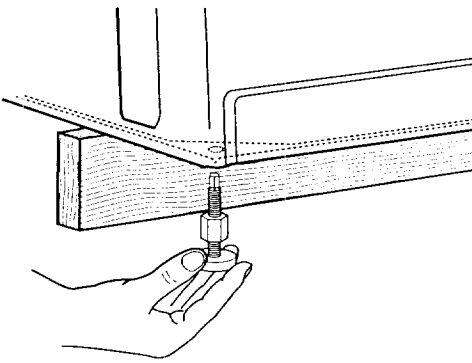

**STEP 4.** Tilt washer backward until front of washer is off the wood block. Remove wood block. Gently lower washer to floor.

**STEP 5.** Move washer to its final location.

**STEP 6.** Tilt washer forward until rear of washer is at least 3 inches off floor. You may hear the self-adjusting rear legs click into place. Lower washer to floor. Check levelness of the washer by placing a level on top of the washer, first side-to-side; then front-to-back.

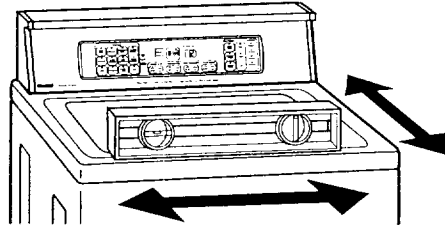

**STEP 7.** If washer is not level, prop up the front of the washer and adjust the legs up or down as necessary. Lower washer and reset self-adjusting rear legs (as in Step 6). Repeat Step 7 until the washer is level.

**STEP 8.** When washer is in its final location and level, use a  $\frac{9}{16}$ -inch open-end wrench to turn nuts on front legs tightly against washer cabinet. If nuts are not tight against washer cabinet, the washer may vibrate.

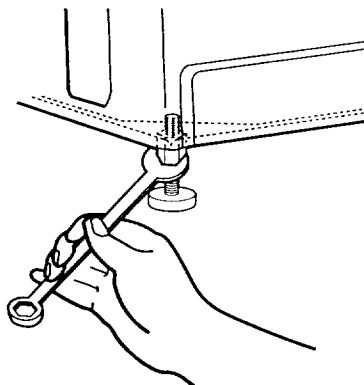

## REVIEW INSTALLATION

### *for your* **Benefit**

Take a few minutes to complete this checklist. It will help assure you that you have a proper installation and increase your satisfaction with your Kenmore washer.

- Check electrical requirements. Be sure you have correct electrical supply and recommended grounding method.
- Check that you have:
  - All the tools you started with.
  - Removed all packaging materials.
  - Removed shipping strap with three cotter pins.
  - Installed all parts listed on pages 6-8.
- Check that:
  - The washer is level.
  - The nuts on the front legs are tight.
- Check that the water faucets are turned on.

INSTALLATION

---

## FINAL STEPS

- Plug power supply cord into grounded outlet.
- Remove the blue protective film on the console and any tape remaining on washer.
- Take a few minutes and read the Operating Instructions (pages 20-36) to fully understand your new washer. Then, start the washer and allow it to complete the HEAVY DUTY Cycle.

## OPERATING YOUR WASHER

### for your Benefit

To get the maximum cleaning and fabric care from your washer, please read and follow these instructions.

### ⚠ WARNING



#### Explosion Hazard

Never place items in the washer that are dampened with gasoline or other flammable fluids.

No washer can completely remove oil.

Do not dry anything that has ever had any type of oil on it (including cooking oils).

Failure to follow these instructions can result in death, explosion, or fire.

**STEP 2. (OPTIONAL STEP)** If desired, add measured liquid chlorine bleach to the liquid bleach dispenser (see pages 34-35).

**STEP 3. (OPTIONAL STEP)** If desired, add measured liquid fabric softener to the fabric softener dispenser (see page 35).

**STEP 4.** Close washer lid.

**STEP 5.** Select the cycle you want by pressing one of the pads under CYCLES **A**. This will turn the washer on. The indicator light for CUSTOM MEMORY will glow (see page 22) and the indicator light for START **G** will begin to flash.

**NOTE:** The settings that are displayed are stored in your washer's CUSTOM MEMORY (see page 22).

**STEP 6. (OPTIONAL STEP)** If desired, change the WATER LEVEL **B**, TEMPERATURE **C**, TIME REMAINING **D** and CYCLE SIGNAL **E** settings that are indicated on your display (see pages 26-28).

**STEP 7. (OPTIONAL STEP)** If desired, set OPTIONS **F** for your wash by pressing the pads for WARM RINSE (see page 27), WRINKLE GUARD and/or SECOND RINSE (see page 29).

### STARTING YOUR WASHER

**STEP 1.** Place a load of sorted clothes in the washer. Add measured detergent directly into dispenser (see pages 33-34).

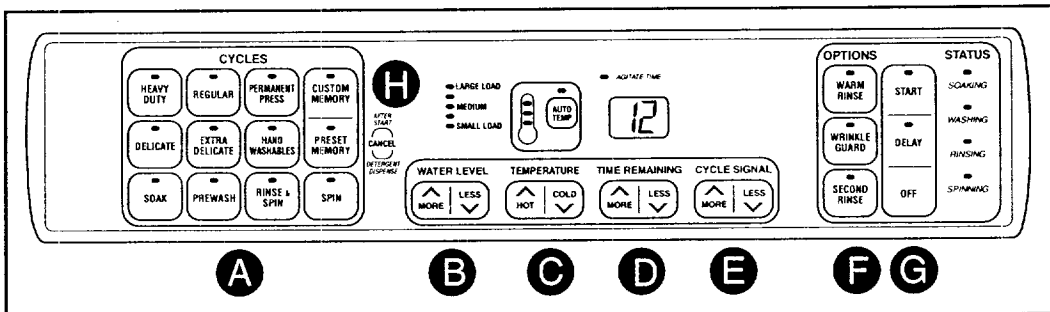

**STEP 8.** Press **START** **G**. The wash cycle will begin. The indicator light for **AGITATE TIME** will turn off and the total cycle time will be displayed in the **TIME REMAINING** display window.

**NOTE:** If you do not press **START** within 15 minutes of selecting the cycle, the washer will automatically shut off.

**STEP 9. (OPTIONAL STEP)** If you added detergent to the washer basket instead of the dispenser, press the pad that reads **AFTER START CANCEL DETERGENT DISPENSE** **H**. This will cancel the detergent dispenser operation and shorten your fill time.

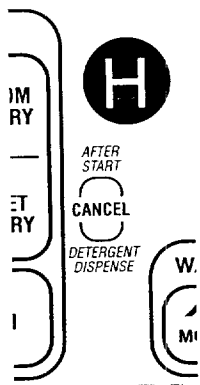

### PAUSING/RESTARTING YOUR WASHER

- To pause the washer at any time, press **DELAY** **G**. Pressing **DELAY** will not change any of the settings you have selected. See page 30 for a complete description of the **DELAY** feature.
- Press **START** to restart. If you do not press **START** within 15 minutes of pausing, the washer will automatically shut off.

### STOPPING YOUR WASHER

- To stop the wash cycle, press **OFF** **G**.
- Reset the washer to **SPIN** to empty water from the basket.
- Reset to a wash cycle to continue washing the load.

### CHANGING CYCLES/OPTIONS

The cycles and options selected may be changed any time before **START** is pressed. A single short tone will sound when a selection is made. If an unavailable combination is selected (a hot wash with **WARM RINSE** Option, for example), three short tones will sound and the last selection will not be accepted.

The cycle and options may be changed after you have pressed **START** if the washer is still in the wash agitation portion of the original cycle:

**STEP 1.** Select the new cycle you want by pressing one of the pads under **CYCLES**. This will stop the washer.

**STEP 2.** Reset the options if desired.

**STEP 3.** Press **START** to restart the washer at the beginning of the new cycle. If you do not press **START** within 15 minutes of pausing, the washer will automatically turn off.

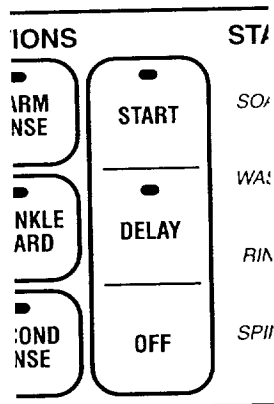

OPERATION



## for your Benefit

This page describes the two ways you can operate your washer. One way is to use the **PRESET MEMORY**. This will provide the recommended fabric care settings for each cycle. These settings have been preset at the factory and cannot be changed.

The second way to operate your washer is to use the **CUSTOM MEMORY**. Using **CUSTOM MEMORY** lets you change and store the washer settings that you use most frequently for each cycle.

### PRESET MEMORY

To use the **PRESET MEMORY** settings:

**STEP 1.** Select the cycle you want by pressing one of the pads under **CYCLES**.

**STEP 2.** Press **PRESET MEMORY**. The indicator light for **PRESET MEMORY**

light will glow and the recommended settings (chart below) will be displayed.

**NOTE:** Once you select **PRESET MEMORY**, any changes made to the recommended settings will not be remembered.

**STEP 3.** Press **START**. The wash cycle will begin.

### CUSTOM MEMORY

Each time you select a cycle, the indicator light for **CUSTOM MEMORY** will glow and the console will display all of the adjustments that were made to the **CYCLES** and **OPTIONS** settings the last time that cycle was started.

- To use these settings, press **START**. The wash cycle will begin.
- To change any setting, or to add options, press the appropriate pad and press **START**. The washer will use the new settings in **CUSTOM MEMORY** the next time you use that cycle.

**PRESET MEMORY SETTINGS**

Cycle	Agitation Time	Water Level	Wash/Rinse Temperature*
HEAVY DUTY	10 minutes	High	Warm/Cold
REGULAR	10 minutes	High	Warm/Cold
PERMANENT PRESS	8 minutes	High	Warm/Cold
DELICATE	6 minutes	High	Warm/Cold
EXTRA DELICATE	5 minutes	High	Cold/Cold
HAND WASHABLES	5 minutes (agitation and soaking)	High	Cold/Cold
SOAK	31 minutes (fast speed agitation/soak)	High	Warm Wash/ No Rinse
PREWASH	4 minutes	High	Warm Wash/ No Rinse
RINSE & SPIN	4 minutes <sup>†</sup> (fast speed agitation)	High	No Wash/ Cold Rinse
SPIN	6 minutes <sup>†</sup> (fast speed spin)	N/A	N/A

\*All temperatures in **PRESET MEMORY** will not have Automatic Temperature Control.

<sup>†</sup>The total cycle time will appear in the **TIME REMAINING** display, including an estimate for drain times.

## CHOOSING YOUR CYCLES

### (Cycle Selection Pads)

Use this control to choose the right wash cycle for the type of fabrics you are washing.

### **for your Benefit**

For improved fabric care at water levels below MEDIUM, the wash action will automatically change. This change will happen in every cycle except HEAVY DUTY and EXTRA DELICATE.

- For most loads, use the time recommended in the PRESET MEMORY.
- For heavy soil and sturdy fabrics, use the full time.
- For light soil and delicate fabrics, use less time.

### HEAVY DUTY

Use this cycle to get between 6 and 14 minutes of wash time for loads of sturdy, colorfast fabrics such as work clothes and diapers. Cycle combines fast speed agitation and fast spin speeds.

### REGULAR

Use this cycle to get between 6 and 14 minutes of wash time for normally soiled cottons and linens. Cycle combines slow speed agitation and fast spin speeds.

### PERMANENT PRESS

### **for your Benefit**

The PERMANENT PRESS Cycle includes a load cooling process that reduces wrinkling compared to other cycles.

You can select 6 to 10 minutes of wash time for use with no-iron fabrics, sport shirts, blouses and cotton slacks. The first 2 minutes of the wash cycle have fast speed agitation followed by the remainder at slow speed. Next, the washer will drain and pause for no more than two minutes while some of the wash water is drained and replaced with rinse water. For maximum benefit in reducing wrinkles, do not use the WARM RINSE Option.

The cycle is completed with a deep rinse at fast speed agitation with "stepped" spin speeds (spins start at an extra-slow speed and gradually move to slow speed before finishing at a fast speed to reduce wrinkling).

### DELICATE

Use this cycle to get between 4 and 8 minutes of slow speed agitation for delicate fabrics and bulky knits that wrinkle easily. The agitation is followed by a deep rinse and a slow spin speed.

### EXTRA DELICATE

Use this cycle to get 4 to 6 minutes of extra-slow speed agitation for sheer fabrics and lingerie. The agitation is followed by a deep rinse and a slow spin speed.

### HAND WASHABLES

Use this cycle to get 4 to 6 minutes of wash time for hand washable and special-care items. Garments are labeled "Hand Wash" because:

- The fiber or construction may be sensitive to agitation.
- The fabric contains sensitive dyes that may bleed.

The wash action mirrors the way you would treat hand washable garments in a sink. It does this by repeating periods of extra-slow speed agitation (10 seconds) and soaking (20 seconds). Slow spin speeds help reduce wrinkling. Do not use HAND WASHABLES for large items like blankets. To protect fabrics, bleach is not dispensed during the HAND WASHABLES Cycle.

**NOTE:** Some "HAND WASH" items, particularly wool, naturally shrink when washed either in the sink or in the washer HAND WASHABLES Cycle. Keep this in mind when you purchase items labeled "HAND WASH." Items that shrink should be dried flat. Block these items by gently stretching to original measurements.

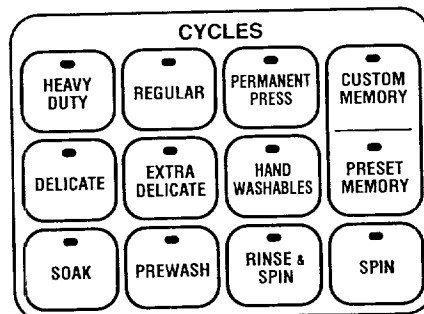

## CHOOSING YOUR CYCLES (Continued)

### PREWASH

Use this cycle to get from 3 to 6 minutes of agitation to help remove heavy soils and stains that need pretreatment. The agitation and spin will be at fast speed unless another speed combination is selected as described below.

### SOAK

SOAK Cycle provides from 11 to 61 minutes of soaking with brief periods of agitation to help remove heavy soils and stains that need pretreatment. Clothes are not rinsed following the SOAK Cycle. The agitation and spin will be at fast speed unless another speed combination is selected as described below.

**NOTE:** PREWASH and SOAK Cycles should be followed by a wash cycle with additional detergent.

**To select a different speed combination for PREWASH or SOAK:**

**NOTE:** These steps must be followed in the order listed.

**STEP 1.** Add detergent to washer basket for the PREWASH or SOAK Cycle.

**STEP 2.** Select the cycle you want by pressing one of the pads under CYCLES (see chart at right).

**STEP 3.** Press PREWASH or SOAK.

**STEP 4.** Make adjustments (if desired) to WATER LEVEL, TEMPERATURE and TIME REMAINING.

**STEP 5.** Press START. The wash cycle will begin.

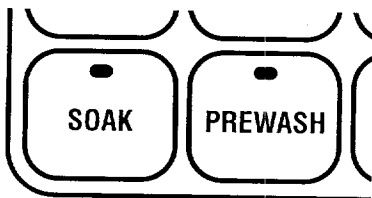

**To automatically follow PREWASH or SOAK with a main wash cycle:**

**NOTE:** These steps must be followed in the order listed.

**STEP 1.** Add detergent to washer basket for the PREWASH or SOAK Cycle.

**STEP 2.** Add detergent for main wash to dispenser.

**STEP 3.** Press PREWASH or SOAK.

**STEP 4.** Make adjustments (if desired) to AGITATE TIME for PREWASH or SOAK Cycle.

**STEP 5.** Select the cycle you want by pressing one of the pads under CYCLES (see chart below).

**STEP 6.** Make adjustments (if desired) to WATER LEVEL and TEMPERATURE.

**STEP 7.** Make adjustments (if desired) to AGITATE TIME for main wash cycle.

**STEP 8.** Press START. The wash cycle will begin.

**NOTE:** The water level and temperature will be the same for PREWASH or SOAK and the main wash cycle.

PREWASH AND SOAK CYCLE AGITATION AND SPIN SPEEDS		
Speed	Agitation Cycle	Spin Speed
HEAVY DUTY	FAST	FAST
REGULAR	SLOW	FAST
PERMANENT PRESS	FAST	SLOW
DELICATE	SLOW	SLOW
EXTRA DELICATE	EXTRA SLOW	SLOW
HAND WASHABLES	INTERMITTENT EXTRA SLOW	SLOW

## CHOOSING YOUR CYCLES (Continued)

### RINSE AND SPIN

Use this cycle to get a deep rinse with agitation followed by a drain and spin. The agitation and spin will be at fast speed unless another speed combination is selected as described below. The TIME REMAINING display will include an estimate of how long it will take to fill and drain the washer.

#### When to use RINSE & SPIN

- For loads that need rinsing only.
- When using extra detergent with a load.
- For completing a cycle after the power has been off.
- To add fabric softener to clothes.

#### To use or change RINSE & SPIN settings:

**STEP 1.** Add fabric softener to the dispenser (if desired).

**STEP 2.** Select the cycle you want by pressing one of the pads under CYCLES.

**STEP 3.** Press RINSE & SPIN.

RINSE & SPIN AGITATION AND SPIN SPEEDS				
Cycle	Agitation		Spin	
	Time	Speed	Time	Speed
HEAVY DUTY	4 min.	FAST	6 min.	FAST
REGULAR	4 min.	SLOW	6 min.	FAST
PERMANENT PRESS	2 min.	FAST	1 min. 3 min. 1 min.	EXTRA SLOW SLOW FAST
DELICATE	2 min.	SLOW	4 min.	SLOW
EXTRA DELICATE	2 min.	EXTRA SLOW	4 min.	SLOW
HAND WASHABLES	2 min.	INT. EXTRA SLOW	4 min.	SLOW

**STEP 4.** Select WARM RINSE, WRINKLE GUARD and/or SECOND RINSE Options (if desired).

**STEP 5.** Press START. The wash cycle will begin.

### SPIN

Use this cycle to drain the washer and spin the load. The spin will be 6 minutes at fast speed unless another spin speed is selected as described below.

#### When to use SPIN:

- To drain the washer after canceling a cycle.
- To complete a cycle after the power has been off.
- To shorten drying times for some heavy fabrics.
- To drain the washer after a long manual soak.
- To remove water from rain wear or beach towels, etc.

#### To use or change SPIN speed setting:

**STEP 1.** Select the cycle you want by pressing one of the pads under CYCLES (see chart below).

**STEP 2.** Press SPIN.

**STEP 3.** Select WRINKLE GUARD Option (if desired).

**STEP 4.** Press START. The wash cycle will begin.

SPIN SPEEDS AND TIMES		
Cycle	Spin	
	Time	Speed
HEAVY DUTY	6 minutes	FAST
REGULAR	6 minutes	FAST
PERMANENT PRESS	1 minute 3 minutes 1 minute	EX.-SLOW SLOW FAST
DELICATE	4 minutes	SLOW
EXTRA DELICATE	4 minutes	SLOW
HAND WASHABLES	4 minutes	SLOW

## TIME REMAINING

These pads allow you to increase or decrease the agitation time for any wash cycle. Minimum and maximum agitation times vary depending on the cycle selected (see pages 23-25).

Once a cycle is selected, the agitation time from the last time the cycle was used will be displayed and the AGITATE TIME will glow.

- To increase the time, press MORE under the TIME REMAINING display.
- To decrease the time, press LESS under the TIME REMAINING display.
- When a wash cycle is started, the approximate time for the complete cycle, including an estimate for drain times, will appear in the TIME REMAINING display. The time will count down to the end of the cycle.
- Once the cycle has started, you cannot change the cycle time using the TIME REMAINING adjustment pads.
- If you are using the delay feature, the hours of delay time will appear in the TIME REMAINING display until the delay time is complete (see page 30 for instructions on using the DELAY feature).

● AGITATE TIME



TIME REMAINING



## SET WATER LEVEL CONTROL

**for your Benefit**

This control gives you the flexibility to save water when washing small loads.

Your washer lets you select a water level setting based on the size of your wash load.

- To change to a higher water level setting after the washer has started to agitate, press MORE under the WATER LEVEL display.
- For normal loads, start with the MEDIUM (middle) setting. Adjust up or down depending on your load. Clothes should move freely and roll toward the agitator.

**NOTE:** When you select a water level below MEDIUM, the washer automatically lowers the agitation speed in order to provide improved fabric care. This change happens in every cycle except HEAVY DUTY and EXTRA DELICATE.

- LARGE LOAD
- MEDIUM
- SMALL LOAD

WATER LEVEL



## SET TEMPERATURE CONTROL

Your washer lets you select a wash and rinse water temperature setting based on the type of load you are washing.

- The wash water temperature used the last time a cycle was run is stored in CUSTOM MEMORY and is displayed when the cycle is selected again.
- The TEMPERATURE Control adjusts the temperature of the wash water only. All rinses are cold unless the WARM RINSE Option is selected.
- You cannot select WARM RINSE with a hot wash due to federal standards for energy conservation.

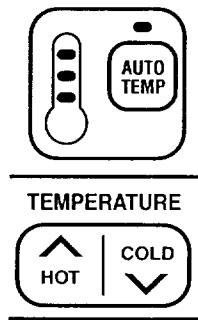

## WARM RINSE OPTION

Selecting this option changes the preset cold rinse to warm rinse unless a hot wash is selected. Pressing WARM RINSE with a hot wash selected will result in three short tones sounding – which indicates an unavailable option was selected.

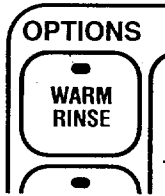

- We recommend cold rinses for most loads to reduce wrinkling and save energy. Cold rinses have proven to be as effective as warm rinses and they save the energy necessary to heat the water.
- Warm rinse is regulated at approximately 75°F for all warm rinses. This may be a cooler warm rinse than what you are used to, but it saves energy and still gives you proper rinsing and a load that is comfortable to remove.
- Warm rinse water will leave loads dryer after the spin cycle than if you use cold rinse water. However, warm rinses may increase wrinkling when line drying.
- In cold climates, warm rinse water also provides a more comfortable temperature for handling the wash load.

SELECTING WATER TEMPERATURES		
Wash Water Temperature	Suggested Fabrics	Comments
HOT 120°F or above	<ul style="list-style-type: none"> <li>• Work clothes</li> <li>• Sturdy whites/ colorfast pastels</li> <li>• Diapers</li> </ul>	<ul style="list-style-type: none"> <li>• Best cleaning for heavily soiled items</li> <li>• Removes oils, perspiration, greasy soils and stains</li> <li>• Prevents graying or yellowing</li> </ul>
WARM 90°-110°F	<ul style="list-style-type: none"> <li>• Dark/non-colorfast colors</li> <li>• Permanent press items</li> <li>• Nylon, polyester, acrylics, silks, woolens</li> <li>• Knits/delicate fabrics</li> </ul>	<ul style="list-style-type: none"> <li>• Best for moderately soiled to lightly soiled items</li> <li>• Safe for most fabric finishes</li> <li>• Less fading and dye bleeding</li> <li>• Reduces wrinkling</li> </ul>
COLD* 70°-90°F	<ul style="list-style-type: none"> <li>• Extra-sensitive colors</li> <li>• Non-colorfast items</li> <li>• Hand washables</li> </ul>	<ul style="list-style-type: none"> <li>• Best for very lightly soiled items</li> <li>• Saves hot water</li> </ul>

\*In wash water temperatures colder than 70°F, detergents do not dissolve well. Also, soils may be difficult to remove and some fabrics may retain wear wrinkles and have increased pilling – the formation of small lint-like balls on the surface of garments. Pilling is the natural result of wearing and washing of garments.

## AUTOMATIC TEMPERATURE CONTROL (ATC)

### *for your* **Benefit**

**ATC takes away the worry of undissolved detergent and ensures consistent cleaning results from season to season with warm and cold washes.**

ATC electronically senses and maintains a uniform water temperature by regulating incoming hot and cold water.

- Even in cold wash, some warm water is let into the washer to maintain a temperature of approximately 75°F. In very cold water, detergent may not dissolve and clothes will not be cleaned completely.
- ATC does not control the hot wash water temperature.
- Warm wash is regulated at approximately 100°F.
- Warm rinse is regulated at approximately 75°F for all warm rinses. This may be a cooler warm rinse than what you are used to, but it saves energy and still gives you proper rinsing and a load that is comfortable to remove.
- The second fill in the PERMANENT PRESS Cycle is for cooling the load and uses unregulated cold water.

ATC can be turned on and off by pressing the pad for AUTO TEMP next to the TEMPERATURE display.

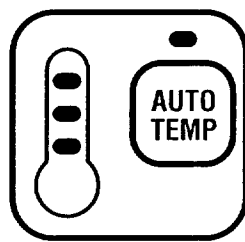

**TEMPERATURE**

## ADJUSTABLE CYCLE SIGNAL

A tone will sound at the end of the wash cycle. The sound level of this tone can be adjusted from loud to off by pressing MORE or LESS under the CYCLE SIGNAL display. The tone you will hear at the end of the cycle will sound as the pads are pressed.

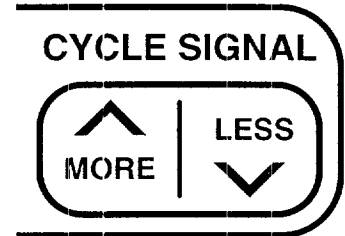

## CHOOSING OPTIONS

### WARM RINSE

For more information on WARM RINSE, see page 27.

### WRINKLE GUARD

#### **for your Benefit**

Selecting WRINKLE GUARD changes the final spin in any cycle to a shorter time and/or a lower speed to reduce wrinkling.

WRINKLE GUARD can be used with RINSE & SPIN and SPIN. We do not recommend WARM RINSE with WRINKLE GUARD. The difference between final spins in cycles with and without WRINKLE GUARD are shown below.

### SECOND RINSE

#### **for your Benefit**

Selecting this option provides a second deep rinse with the same water temperature as selected for the first rinse.

SECOND RINSE can be added to any main wash cycle and RINSE & SPIN.

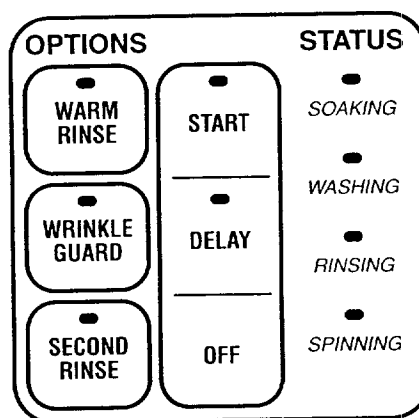

FINAL SPIN SPEEDS AND TIMES				
Cycle	Without WRINKLE GUARD		With WRINKLE GUARD	
	TIME	SPEED	TIME	SPEED
HEAVY DUTY	6 minutes	FAST	2 minutes	FAST
REGULAR	6 minutes	FAST	2 minutes	FAST
PERMANENT PRESS	1 minute 3 minutes 1 minute	EXTRA SLOW SLOW FAST	1 minute 3 minutes	EXTRA SLOW SLOW
DELICATE	4 minutes	SLOW	2 minutes	SLOW
EXTRA DELICATE	4 minutes	SLOW	2 minutes	SLOW
HAND WASHABLES	4 minutes	SLOW	2 minutes	SLOW

## OPERATING CONTROLS

### START

Press START to start your washer after a cycle has been selected. Be sure all desired cycle adjustments and options have been selected.

### DELAY

## *for your* Benefit

You can use the DELAY feature to temporarily stop the washer cycle or to delay the start of a wash cycle for up to nine hours.

**To temporarily stop the wash cycle:**

**STEP 1.** Press DELAY. The indicator light for START will blink. Continuation of the cycle can be delayed for up to 15 minutes.

**STEP 2.** Press START to resume the cycle. If you do not press START within 15 minutes, the washer will automatically shut off.

**To delay the start of the wash cycle:**

**STEP 1.** Load the washer and fill the dispensers.

**STEP 2.** Close the washer lid.

**STEP 3.** Select the desired cycle fabric care settings and option selections.

**STEP 4.** Press DELAY. 1H (one hour) will be displayed in the TIME REMAINING window. The indicator lights for START and DELAY will glow.

**STEP 5.** For a longer delay time, press MORE below the TIME REMAINING display window. The time will increase in one hour steps up to nine hours.

**STEP 6.** For a shorter delay time, press LESS below the TIME REMAINING display window. The time will decrease in one hour steps.

**NOTE: Do not press START.** The washer will automatically start after the selected delay time has passed.

**To cancel DELAY do any of the following:**

- Press START to begin the cycle immediately.
- Press OFF to turn the washer off.
- Press one of the pads under CYCLES to select a new cycle.

### OFF

Selecting this control turns the washer off. It cannot be restarted from where it was stopped in the cycle.

- Reset the washer to SPIN to empty water from the basket.
- Reset to a wash cycle to continue washing the load.

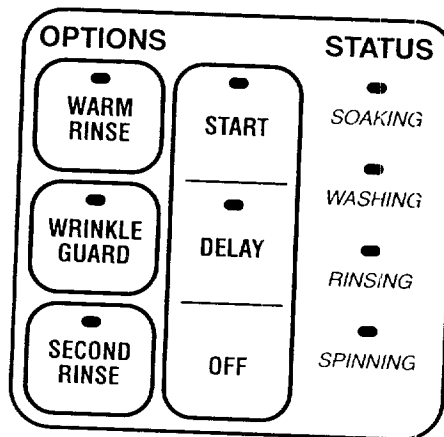

## INDICATOR LIGHTS

### CYCLE LIGHTS

Located above each pad under CYCLES, these lights show the cycle you have selected.

### MEMORY LIGHTS

These lights show if the washer is operating in CUSTOM MEMORY or PRESET MEMORY. See page 22 for a complete description of PRESET and CUSTOM MEMORY.

### OPTION LIGHTS

These lights show the setting of the WATER LEVEL, TEMPERATURE and TIME REMAINING.

### RINSE OPTION LIGHTS

These lights show when WARM RINSE, WRINKLE GUARD and/or SECOND RINSE have been added to the cycle.

### START AND DELAY LIGHTS

These lights show that the washer has started or temporarily stopped or that DELAY has been selected.

### STATUS LIGHTS

Located on the right side of the console, these lights show in what portion of the cycle the washer is operating: SOAKING, WASHING, RINSING or SPINNING.

## SELF-CLEANING LINT FILTER

**for your Benefit**

**Lint is filtered from the load automatically – there's no messy cleanup.**

Your washer features a self-cleaning filter that traps lint from the water while the washer is washing and deep rinsing the laundry. The trapped lint is flushed down the drain automatically. You don't have to clean the filter.

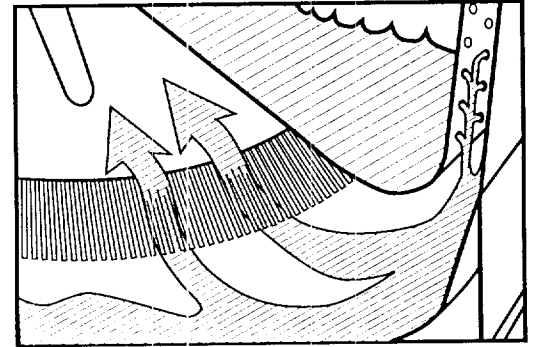

### QUIET PAK™ PLUS

The QUIET PAK™ System is designed to reduce water sounds and ringing noises. The cabinet is insulated with sound-dampening materials for superior vibration and sound-damping characteristics. A sound-absorbing blanket under the motor and gearcase also helps to insulate the washer to reduce vibration noise.

OPERATION

## TRIPLE ACTION™ AGITATOR

### *for your* **Benefit**

Kenmore's exclusive TRIPLE ACTION™ Agitator gives you the most flexible fabric care for even your largest loads.

The TRIPLE ACTION™ Agitator moves in three directions, depending on load size, to ensure proper cleaning. The best cleaning action in your washer takes place at the bottom where the agitator vanes move back and forth to flex the fabric, loosening the soil.

The upper portion of the agitator features special vanes that push the clothes down in a spiraling pattern to where the cleaning action is, displacing the clothes that are there with a "roll-over" motion.

For your largest loads, the TRIPLE ACTION™ Agitator offers a load-sensing feature that actually senses when you are washing a really large load and responds by telling the top part of the agitator to move in an additional up and down motion. This ensures that all clothes get moved down to the lower vanes.

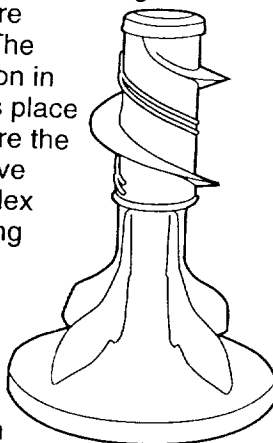

## UNDERSTANDING NORMAL WASHER SOUNDS

Your new washer may make sounds that your old one didn't. Because the sounds are unfamiliar, you may be concerned about them.

The following describes some of the normal sounds you may hear and what causes them.

### **During Washing**

When you select a small load size setting for a small wash load, your washer has a lower water level. With this lower water level, you may hear a clicking sound from the upper portion of the agitator.

### **During Drain**

The rate that water is drained from your washer depends on your installation. If water is drained quickly from the washer, you may hear air being pulled through the pump. This happens during the end of draining.

### **After Drain and Before Spin**

When the cycle changes from draining to spinning, you may hear a noise as the gearcase shifts.

### **When Selecting a Cycle, a Cycle Adjustment, or a Cycle Option**

- A single tone will sound whenever a selection is accepted by the program.
- Three short tones will sound if an unavailable selection is made (a hot wash with WARM RINSE, for example).
- The sound level of the selection tones is not adjustable.

## USING YOUR TRIPLE DISPENSER

### *for your* **Benefit**

The triple dispenser makes your washer truly automatic by making it unnecessary for you to return to the washer during the cycle to put in detergent, bleach, or fabric softener.

By using the triple dispenser, you are assured of proper fabric care by ensuring that detergent, bleach, and fabric softener are introduced into the washer at the proper time and properly diluted.

#### How It Works

The triple dispenser directs fresh water from the washer inlet valve to the dispensers.

The water directed to the dispenser will be warm if both faucets are turned on fully, regardless of wash or rinse temperature selections. This is to ensure good dilution of laundry products. The amount of warm water is not enough to harm delicate or non-colorfast fabrics.

## USING THE DETERGENT DISPENSER

This dispenser will automatically dispense either liquid or dry detergents. It holds and automatically dispenses the detergent at the beginning of the main wash cycle. Warm water is used for dispensing regardless of water temperature selected. The amount of warm water is not enough to harm delicate or non-colorfast fabrics.

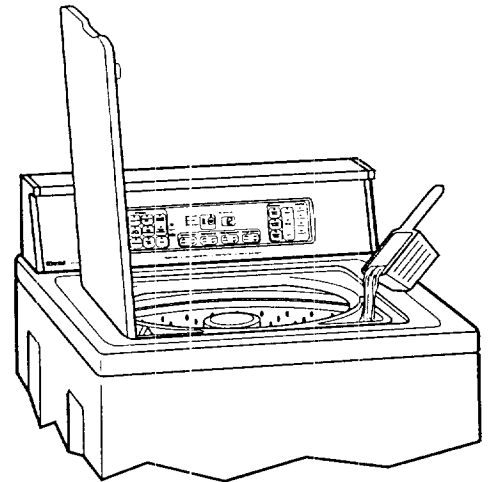

OPERATION

#### SOAK and PREWASH Cycles

- Add detergent or presoak product to washer basket for SOAK or PREWASH Cycles. The detergent dispenser will not dispense in these cycles.
- If you are following SOAK or PREWASH with a regular wash cycle, add detergent for the main wash into the dispenser. Then add detergent or presoak product for the SOAK or PREWASH Cycles into the washer basket. This will permit you to use the SOAK and PREWASH Cycles without returning to the washer.
- Follow package recommendations for the amount to use. Add clothes to washer.

**If using Powdered Detergent:**

- Remove the Liquid Detergent Cup or the Flow Diverter. Powdered detergent can clog these parts. Add detergent directly to dispenser.

**If using Liquid Detergent:**

- Use the Liquid Detergent Cup and Flow Diverter only for liquid detergents.
- Do not overfill or dispenser will empty too soon. Dispenser holds 1/2 cup.

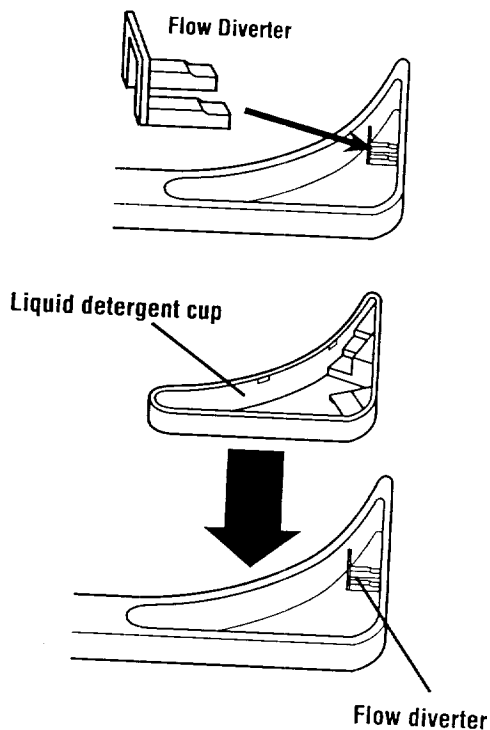

**USING THE LIQUID CHLORINE BLEACH DISPENSER**

**for your Benefit**

Automatically dispenses bleach at the proper time in the cycle to ensure the cleanest and brightest loads.

**Always measure liquid chlorine bleach**  
Use a measuring cup, do not guess. Do not pour directly from bottle. Never use more than 1 cup for a full load. Use less with smaller loads. Follow manufacturer directions for safe use. A cup with a pouring spout will help you avoid spilling.

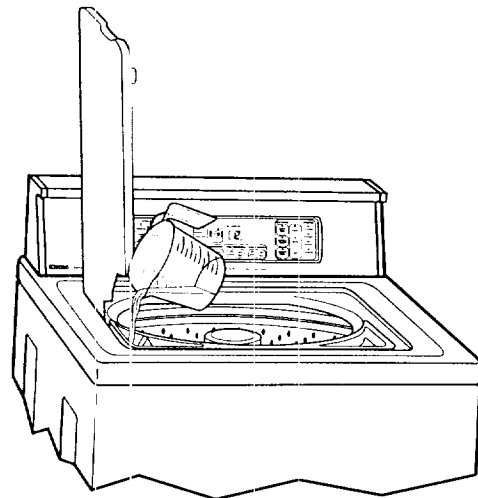

After loading the washer, pour measured liquid chlorine bleach carefully into the dispenser.

- To protect fabrics, bleach is not dispensed during the SOAK, PREWASH or HAND WASHABLES Cycles.

- Do not let bleach splash, drip, or run down into washer basket. Undiluted bleach will damage any fabric it touches.
- Start the washer. Bleach will be dispensed automatically after the detergent has had time to work.

**NOTE:** Do not use this dispenser to add powdered chlorine or color-safe bleach to your wash load. The dispenser is for liquid chlorine bleach only.

- **Do not overfill or dispenser will empty too soon.** Look for the level that reads "DO NOT FILL ABOVE THIS LEVEL." Dispenser holds 1 cup.

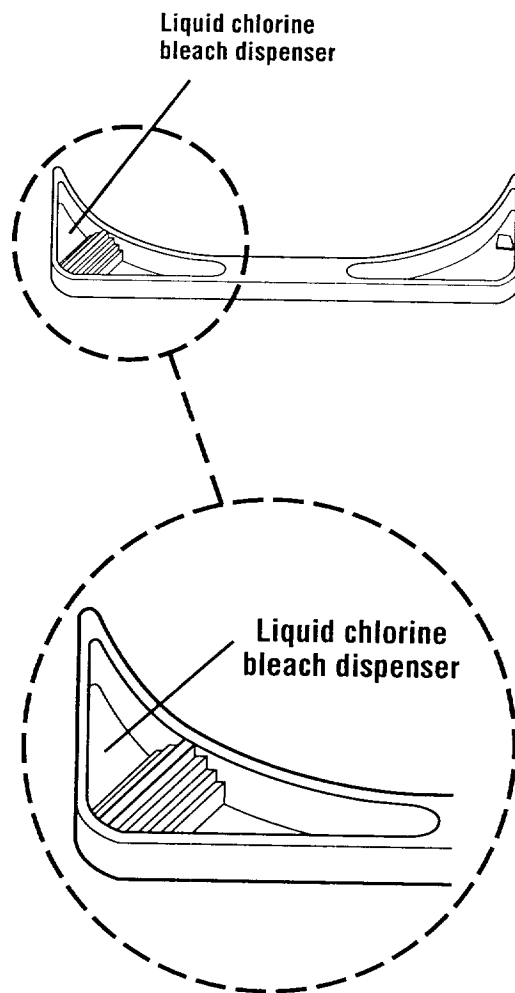

## USING THE LIQUID FABRIC SOFTENER DISPENSER

After loading the washer, measure and add the recommended amount of fabric softener into the dispenser. Follow manufacturer's directions.

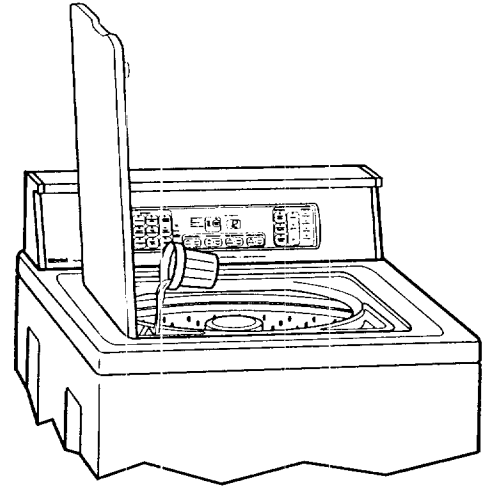

- Add warm water to fill the dispenser to the level that reads "DO NOT FILL ABOVE THIS LEVEL."
- **Do not overfill or dispenser will empty too soon causing stains on load.** Dispenser holds  $\frac{2}{3}$  cup.
- Fabric softener is dispensed in **SECOND RINSE** if **SECOND RINSE** is selected.

**NOTE:** Undiluted fabric softener spilled on fabric may result in spots that look like oil stains.

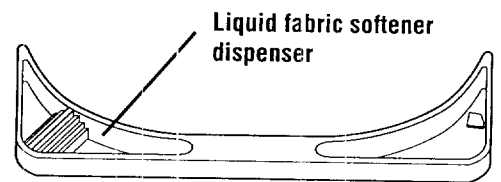

### To clean the Liquid Fabric Softener Dispenser:

Scrub with a brush using a liquid laundry detergent solution. Never use any cleaning fluids on dispenser parts as damage can result to the plastic.

# UNDERSTANDING WHAT HAPPENS IN EACH CYCLE

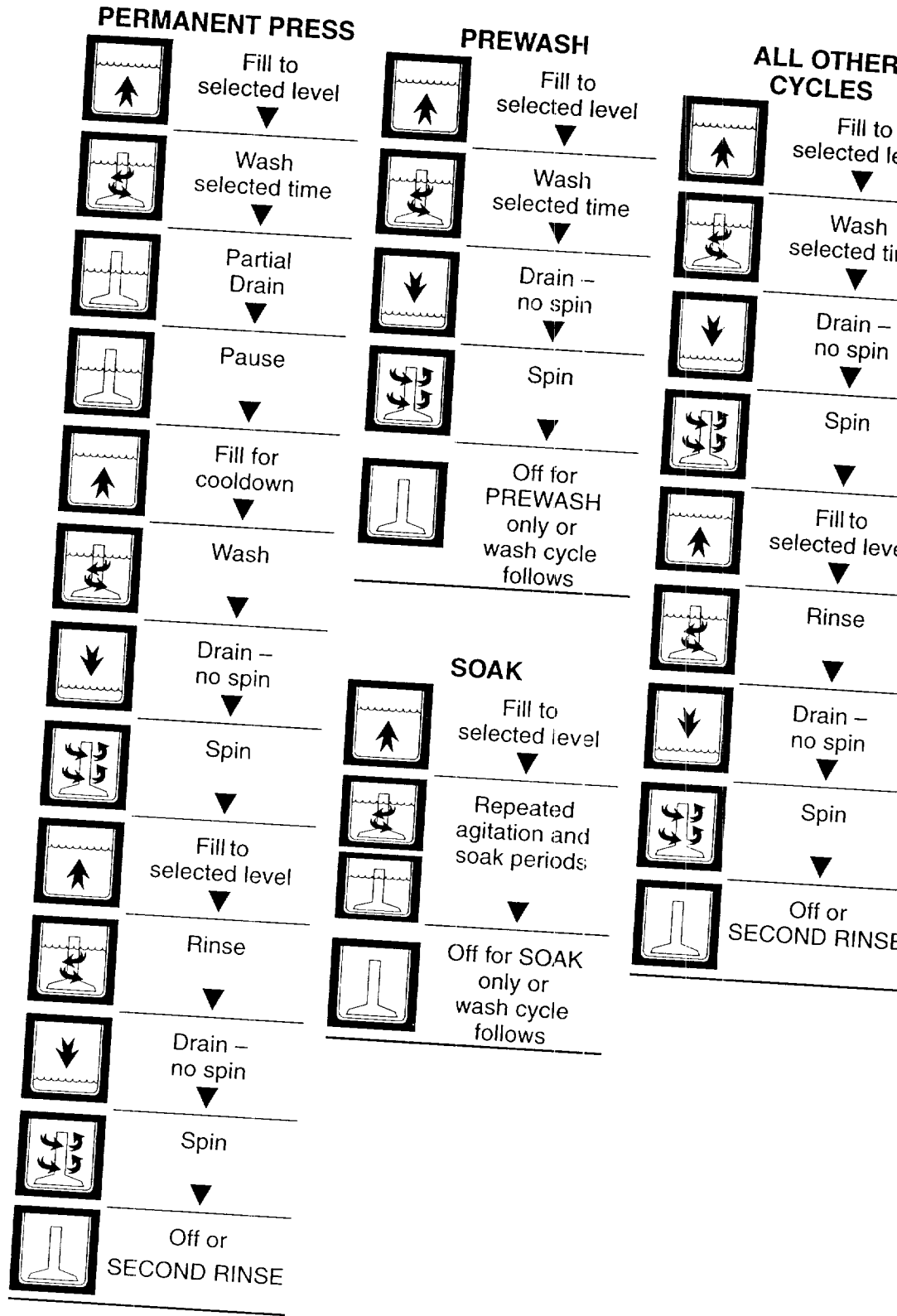

## LAUNDRY TIPS

### PREPARING CLOTHES FOR WASHING

#### *for your* **Benefit**

Follow these recommendations to help you prolong the life of your garments.

- Close zippers, snaps, and hooks to avoid snagging other items. Remove pins, buckles, and other hard objects to avoid scratching the washer interior. Remove non-washable trim and ornaments.
- Empty pockets and turn them inside out.
- Turn down cuffs, brush away lint and dirt.
- Turn synthetic knits inside out to avoid pilling.
- Tie strings and sashes so they will not tangle.
- Mend tears, loose hems, and seams.
- Treat spots and stains.
- Stained or wet garments should be washed promptly for best results.

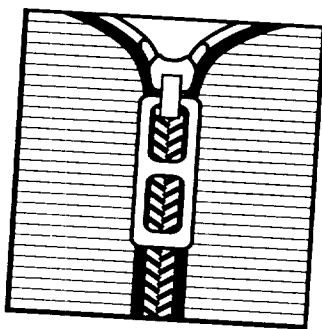

### SORTING

- Separate heavily soiled items from lightly soiled ones, even if they would normally be washed together. Separate lint givers (towels, chenille) from lint takers (corduroy, synthetics, permanent press). When possible, turn lint givers inside out.
- Separate dark colors from light colors, colorfast items from non-colorfast items.
- Sort by fabric and construction (sturdy cottons, knits, delicate items).

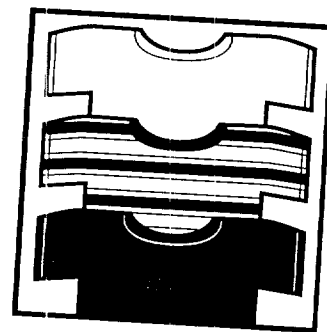

## LOADING

### *for your* **Benefit**

Proper loading of your washer contributes to proper cleaning and fabric care and reduces machine noise.

- Drop items into washer loosely. Fill to the top of the basket (top row of holes). Do not wrap items around the agitator. Items should move easily through wash water for best cleaning and wrinkle-free results. Items should sink and reappear later.
- Load washer properly and select correct water level setting. Overloading or packing the machine, and selecting a setting too small for the wash load can:
  - cause poor cleaning
  - increase wrinkling
  - create excessive lint
  - wear out items faster (because of pilling)
- Load by the amount of space items take up, not by their weight.
- Mix large and small items in each load. Load evenly to maintain washer balance. An off-balance load can make the washer vibrate during spin.
- Use a higher water level setting to reduce wrinkling with permanent press clothes and some synthetic knits. These items should have more room to move in the water than heavy items (towels, jeans).
- Reduce wash time by using a lower water level setting. Loads with only a few small items need less wash time.

## LOADING SUGGESTIONS

For these suggested full-sized loads, set the WATER LEVEL pad to the highest water level setting.

SUPER CAPACITY PLUS WASHERS		
Heavy Work Clothes	Towels	Mixed Load
4 jeans	10 bath towels	3 sheets (1 king, 2 twin)
4 workpants	10 hand towels	4 pillowcases
4 workshirts	14 wash cloths	3 shirts
2 sweatshirts		3 blouses
2 sweatpants		9 T-shirts
		9 shorts
		10 handkerchiefs

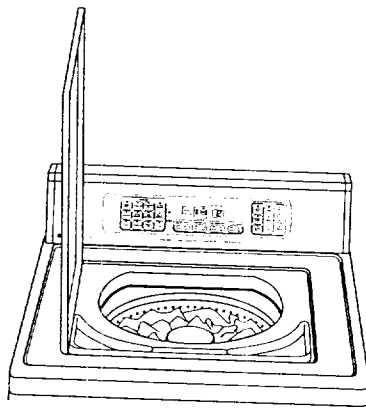

# CARING FOR YOUR WASHER

## CLEANING YOUR WASHER

Proper care of your washer can extend its life. This section explains how to care for your washer properly and safely.

### Exterior

Wipe up detergent, bleach, and other spills with a soft, damp cloth or sponge as they occur. Occasionally wipe the outside of the washer to keep it looking like new.

Do not put sharp or metal objects in your washer. They can damage the finish. Check all pockets for pins, clips, money, bolts, nuts, etc. Do not lay these objects on your washer after emptying pockets.

### Interior

Clean interior with 1 cup of chlorine bleach mixed with 2 cups of detergent. Run washer through a complete cycle using hot water. Repeat process if necessary.

**NOTE:** Remove hard water deposits using only cleaners labeled as washer safe.

## WATER INLET HOSES

Replace inlet hoses after five years of use to reduce the risk of hose failure. Periodically inspect and replace inlet hoses if bulges, kinks, cuts, wear, or leaks are found. When replacing your inlet hoses, mark the date of replacement on the label with a permanent marker.

## FLUORESCENT CONSOLE LIGHT

Lights the console and washer top. The light is turned on and off by a rocker switch at the right front top of the console, partially under the washer console lid.

To turn the light on:

**STEP 1.** Push the lower part of the switch down and hold for a few seconds until the light starts to glow.

**STEP 2.** Release the switch, the light will turn on.

To turn the light off, push the upper part of the switch.

## Changing the Fluorescent Light Bulb:

**STEP 1.** Unplug the washer power supply cord from the electrical supply.

**STEP 2.** Open the lid of the console by lifting the left and right front edges of the textured lid.

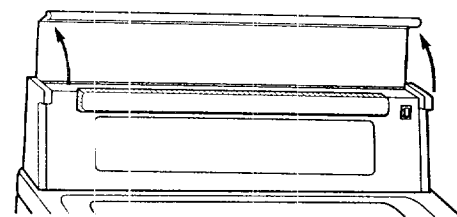

**STEP 3.** Pull off and remove the plastic light cover.

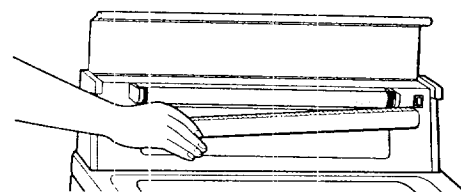

**STEP 4.** Remove the bulb by rotating it in the sockets. Rotate the top of the bulb toward the washer, the bottom of the bulb toward you.

**STEP 5.** Put the new bulb in the socket. Rotate the top of the bulb toward you and the bottom of the bulb toward the console to lock it in place.

**STEP 6.** Replace the plastic light cover.

**STEP 7.** Close the top of the console by pushing down on the left and right front edges of the textured lid.

**STEP 8.** Plug the washer power supply cord into the electrical supply.

## **WINTER STORAGE OR MOVING CARE**

Install and store your washer where it will not freeze. Because some water may stay in the hoses, freezing can damage your washer. If storing or moving your washer during freezing weather winterize it.

### **To winterize washer:**

1. Shut off both water faucets.
2. Disconnect and drain water inlet hoses.
3. Put 1 quart of R.V.-type antifreeze in the basket.
4. Run washer on a SPIN setting for about 30 seconds to mix the antifreeze and water. Some of the mixture will pump out while the washer spins.
5. Unplug the power supply cord.

### **To use washer again:**

1. Flush water pipes and hoses.
2. Reconnect water inlet hoses.
3. Turn on both water faucets.
4. Reconnect power supply cord.
5. Run the washer through a complete cycle with 1 cup of detergent to clean out antifreeze.

## **NON-USE OR VACATION CARE**

Operate your washer only when you are at home. If you will be on vacation not using your washer for an extended period of time, you should:

- Unplug the power supply cord or turn off electrical power to the washer.
- Turn off the water supply to the washer. This helps avoid accidental flooding (due to a water pressure surge) while you are away.

## TROUBLESHOOTING

Most laundering problems are easily solved if you understand the cause. Check these lists for common laundry

and washer problems. If you need further assistance, see page 48.

Problem	Possible Cause	Solution
<b>Message Codes</b>		
"LF" (Long Fill)	Inlet hoses are kinked or clogged.	Straighten inlet hoses.
	Water valve screens are not clear.	Clear screens of any foreign material.
"LD" (Long Drain)	Drain hose is kinked or clogged.	Straighten or unplug hose.
"FF" (Fill Failure)	Problem with water level sensing system.	Call for service.
"OL" (Open Lid)	Lid is open during drain or spin.	Close lid.
"PF" (Power Failure)	Power to washer went off during cycle.	Press any pad to clear the display. Restart the washer from the beginning of the cycle.
<b>Washer Leaks</b>	Household plumbing is leaking.	Repair plumbing.
	Inlet hoses not tight.	Tighten hoses (see "INSTALLATION," Section D).
	Inlet hose washers not properly seated.	Reseat washers. (see "INSTALLATION," Section D).
	Drain hose not properly clamped or is off.	Clamp drain hose. (see "INSTALLATION," Section C).
	Drain is clogged.	Remove drain clogs. Sink, standpipe, or floor drain must be able to handle 17 gallons of water per minute.
	Tub moved forward during unloading, causing water to deflect off of tub ring.	Ensure tub is centered before starting washer.
	Unit not level causing water to deflect off of tub ring.	Ensure front feet are installed and nuts are tightened. Level washer. Reset rear legs (see "INSTALLATION," Section F).
	Load is unbalanced. Spray rinses are deflecting off of load.	Redistribute the load.
	Washer is overloaded. Fills or spray rinses are deflecting off of load.	Reduce load size.



<b>Problem</b>	<b>Possible Cause</b>	<b>Solution</b>
<b>Won't Drain/ Won't Spin/ Wet Loads</b>	Drain hose is kinked or clogged.	Straighten or unplug hose (see "INSTALLATION," Section C).
	Correct operation of neutral drain.	After a wash or rinse, the washer will drain without spinning. After draining the spinning begins.
	Lid is open.	Close the lid.
	Drain hose is more than 96 inches above floor.	Lower drain hose (see "INSTALLATION," Section C).
	Too much detergent – excessive sudsing.	Use less detergent.
	Wrong cycle for load being washed.	Choose a cycle with a higher spin speed (see "OPERATION").
	Low voltage or using an extension cord.	Check electrical source or call electrician. Do not use extension cords.
	Cold rinses.	Cold rinses leave loads wetter than warm rinses. This is normal.
<b>Continues to Fill/ Continues to Drain/ Cycle Stuck</b>	Drain hose is less than 39 inches above floor.	Raise the drain hose (see "INSTALLATION," Section C).
	Drain hose fits tightly into standpipe.	Adjust drain hose for loose fit. (see "INSTALLATION," Section C).
	Drain hose taped into standpipe.	Do not seal off drain hose with tape. The drain hose needs an air gap.
<b>Washer Makes Noise</b>	Load is unbalanced.	Redistribute load.
	Washer is not level. Rear leveling legs not set.	Level washer. Reset rear legs (see "INSTALLATION," Section F).
	Nuts on front feet not tight.	Tighten nuts (see "INSTALLATION," Section F).
	Yellow shipping strap with cotter pins not completely removed.	Remove strap with cotter pins. (see "INSTALLATION," Section B).
	Floor not strong enough to support washer.	Relocate washer (see "INSTALLATION," Section A).
	Gears engaging after drain and before spin.	This is normal.
	Upper part of agitator clicks during wash.	This is normal.

<b>Problem</b>	<b>Possible Cause</b>	<b>Solution</b>
<b>Won't Fill/ Won't Rinse/ Won't Agitate/ Wrong Temperature</b>	Water inlet valve screens are plugged.	Clean screens.
	Water is turned off.	Turn on water.
	Hot and cold hoses are reversed.	Reverse hoses (see "INSTALLATION," Section D).
	Inlet hose is kinked.	Straighten hoses.
	Power cord not plugged in.	Plug in power cord.
<b>Machine Stops</b>	Power cord not plugged in.	Plug in power cord.
	No power at plug.	Check electrical source or call electrician.
	Fuse blown or circuit breaker open.	Replace fuse or reset circuit breaker. If problem continues, call electrician.
	Using an extension cord.	Do not use extension cords.
	OFF pad was pressed.	Set a new wash cycle and press START pad.
	DELAY pad was pressed.	Press START pad to restart washer. If console light is off, set a new wash cycle, then press START pad.
	Washer at pause in PERMANENT PRESS Cycle (approximately two minutes).	Allow cycle to continue (see "OPERATION").
	Machine is overloaded.	Wash smaller loads.
<b>Agitator Not Working</b>	The top of the agitator moves only in one direction.	This is normal.
	The top of the agitator is loose.	This is normal.
<b>Water Level Too Low/Not Completely Filling</b>	The top of the agitator is much higher than the highest water level. This creates a perception of the washer not being full.	This is normal.
<b>Tub is Crooked</b>	Tub pulled forward when unloading.	Ensure tub is centered before starting washer.
	Tub moves.	This is normal.
	Unit not level.	Ensure front feet are installed and nuts are tightened. Level washer. Reset rear legs (see "INSTALLATION," Section F).

<b>Problem</b>	<b>Possible Cause</b>	<b>Solution</b>
<b>Lint on Load</b>	Improper sorting.	Sort lint givers from lint takers and by color.
	Overloading.	Lint can be trapped in load if overloaded. Wash smaller loads.
	Paper or tissue in pockets.	Clean out pockets before washing.
	Not enough detergent.	Use enough detergent to hold lint in water.
	Detergent not dissolving. Water temperatures lower than 60°F.	Use Automatic Temperature Control (ATC). ATC ensures wash water temperature will be warmer than 70°F.
<b>Tearing</b>	Overloading. Improper use of washer.	Loads should move freely during wash. Wash smaller loads.
	Improper use of chlorine bleach. Undiluted bleach will damage fabrics.	Do not pour chlorine bleach directly on load. Wipe up bleach spills.
	Sharp items not removed from pockets; fasteners not fastened.	Clean out pockets before washing. Zip zippers before washing.
	Items damaged before washing.	Mend rips and broken threads in seams before washing.
<b>Stains on Load</b>	Improper use of fabric softener in washer or dryer.	Dilute fabric softener and add to deep rinse only.
	Iron in water (rust).	Install an iron filter.
	Under use of detergent causing soil to be redeposited.	Use enough detergent to remove soil and hold it in suspension.
	Dye transfer due to not sorting loads properly.	Sort dark clothing from whites and lights.
	Dye transfer due to not unloading washer promptly.	Unload the washer as soon as it stops.

<b>Problem</b>	<b>Possible Cause</b>	<b>Solution</b>
<b>Load is Wrinkled</b>	Not removing load promptly.	Unload the washer as soon as it stops.
	Wrong cycle for fabrics being washed.	Use cold rinses and cycles with slow spin speeds to reduce wrinkling.
	Overloading.	Loads should move freely during wash. Wash smaller loads.
	Wash water not warm enough to relax wrinkles. Using warm rinses.	Use Automatic Temperature Control (ATC). If safe for fabric, use warm or hot wash water. Use cold rinse water.
	Hoses reversed.	Reverse hoses (see "INSTALLATION," Section D).
<b>Load is Tangled/ Twisted</b>	Overloading.	Loads should move freely during wash. Wash smaller loads.
	Clothes wrapped around agitator.	Do not wrap items around agitator when loading washer.
<b>Clogged Dispensers/ Bleach Leaking/ Bleach on Wrong Loads</b>	Not diluting softener.	Dilute fabric softener in dispenser.
	Use of color-safe bleach in chlorine bleach dispenser.	Add color-safe bleach directly to the basket or detergent dispenser. Do not use chlorine bleach dispenser.
	Improper use of chlorine bleach.	Always measure bleach before adding to the dispenser. Carefully pour into the dispenser. Wipe up bleach spills.

©2015 Whirlpool Corporation



# SEARS MAINTENANCE AGREEMENT

## KENMORE WASHERS

### We Service What We Sell

"We Service What We Sell" is our assurance you can depend on Sears for service. Your washer has added value when you consider that Sears has service units nationwide, staffed with professional technicians specifically trained on Sears appliances and having parts, tools and equipment to ensure that we meet our pledge to you... "We Service What We Sell."

### Sears Maintenance Agreement

Maintain the value of your Kenmore Washer with a Sears Maintenance Agreement. Kenmore washers are designed, manufactured, and tested for years of dependable operation. Yet any appliance may require service from time to time.

### The Sears Maintenance Agreement

- Is your way to buy tomorrow's service at today's prices.
- Eliminates repair bills resulting from normal use.
- Allows for as many service calls as required.
- Provides for service by professional Sears Trained Technicians.
- Even if you don't need repairs, the Maintenance Agreement offers an annual preventative maintenance checkup at your request!

**For more information,  
call 1-800-827-6655.**

Handwritten text or scribble



**For the repair or replacement parts you need delivered directly to your home**  
Call 7 am - 7 pm, 7 days a week

**1-800-366-PART**  
(1-800-366-7278)

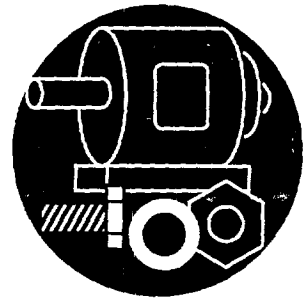

**For in-home major brand repair service**  
Call 24 hours a day, 7 days a week

**1-800-4-REPAIR**  
(1-800-473-7247)



**For the location of a Sears Parts and Repair Center in your area**  
Call 24 hours a day, 7 days a week

**1-800-488-1222**



**For information on purchasing a Sears Maintenance Agreement or to inquire about an existing Agreement**  
Call 9 am - 5 pm, Monday - Saturday

**1-800-827-6655**



**When requesting service or ordering parts, always give the following information:**

- Product Name
- Part Name
- Model Number
- Part Number

