

Dear Customer,

Thank you for purchasing this Smeg 50's Style drip coffee machine.

By choosing one of our products, you have selected an appliance which combines iconic style with innovative technical design and attention to detail.

A Smeg appliance coordinates perfectly with other Smeg products, or works equally great as a standalone statement piece in your kitchen.

We hope you enjoy using your new appliance!

For further information on the product, please visit: www.smeg50style.com or www.smeg.com.

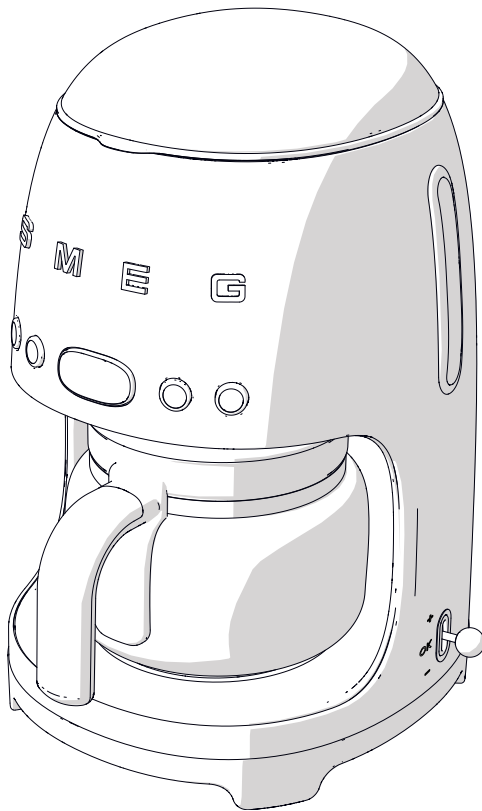

Drip coffee machine

Contents

1 Instructions	24
1.1 Introduction	24
1.2 This user manual	24
1.3 Intended use	24
1.4 General safety instructions	24
1.5 Manufacturer liability	27
1.6 Identification plate	27
1.7 Disposal	27
2 Description	28
2.1 Product description	28
3 Use	29
3.1 Before first use	29
3.2 First use	30
3.3 Accessing the settings menu	30
3.4 How to prepare the coffee	32
4 Cleaning and maintenance	37
4.1 Instructions	37
4.2 Cleaning the drip coffee machine	37
4.3 Cleaning the drip coffee machine components	37
4.4 Descaling	38
4.5 What to do if...	40

EN

TRANSLATION OF THE ORIGINAL INSTRUCTIONS

We advise you to read this manual carefully, as it contains all the instructions for maintaining the appliance's aesthetic and functional qualities.

For further information on the product: www.smeg.com



Instructions

1 Instructions

1.1 Introduction

Key information for the user:

Instructions



General information on this user manual, on safety and final disposal.

Description



Appliance description.

Use



Information on using your appliance.

Cleaning and care



Information for proper cleaning and maintenance of the appliance.



Safety instructions



Information



Advice

1.2 This user manual

This user manual is an integral part of the appliance and must therefore be kept in its entirety and in an accessible place for the whole working life of the appliance.

1.3 Intended use

The appliance can be used to prepare drip coffee. Every other use is considered improper. Do not use the appliance for anything other than its intended use.

1. The drip coffee machine must not be used inside a piece of furniture.
2. **WARNING:** Do not use the appliance if the surface is cracked.

1.4 General safety instructions

- The appliance must not be used by persons (including children) with reduced physical, sensory or mental capabilities or with a lack of experience and knowledge, unless appropriately supervised, or instructed on the safe use of the appliance by a person responsible for their safety.
- Children must be supervised at all times to ensure they do not play with the appliance.
- Cleaning and maintenance of the appliance must not be performed by children, unless closely supervised.
- Do not use the appliance outdoors.



- Never submerge the appliance in water.
- Plug into an earthed 3-pin socket.
- Do not remove the earth pin.
- Do not use an adapter.
- Do not use an extension cord.
- Failure to observe these warnings can lead to fire, electrocution or even death.
- This appliance is intended for household use. Moreover, it cannot be used:
 - In kitchen areas provided for employees in shops, offices and other working environments;
 - In farms/farm stay facilities
 - By guests in hotels, motels and residential environments;
 - In bed and breakfasts.
- If the power cord is damaged, contact technical support to arrange for this to be replaced in order to avoid any possible hazards.
- Children must never play with the appliance.
- The appliance may be used by people with reduced physical, sensory or mental capabilities or lack of experience and knowledge if they have been given supervision or instruction concerning use of the appliance in a safe way and if they understand the hazards involved.
- Disconnect the appliance from the power socket before assembly, disassembly and cleaning.

For this appliance

- Follow all safety instructions in order to use the appliance safely.
- Read this user manual carefully before using the appliance.
- Switch off the appliance immediately after use.
- Do not leave the coffee machine unattended during use.
- Always disconnect the drip coffee machine from the power socket before installing / removing components or cleaning it.
- Unplug the coffee machine before cleaning it and if you notice any fault.
- Allow the drip coffee machine cool down before cleaning it.
- Leave a space of 10 cm around the drip coffee machine.
- Do not use the drip coffee machine if there is no water in the tank.

Only for European markets:

- This appliance may be used by children from the age of 8 provided they are supervised or instructed on the safe use of the appliance and they understand the associated risks.
- Cleaning and maintenance may be performed by children from the age of 8 as long as they are appropriately supervised.
- Keep the appliance and its cord out of reach of children under the age of 8 years.



Instructions

- Use cold, preferably filtered, water. Do not use other liquids.
- Make sure that the lid is firmly closed.
- Danger of burns! Do not open the lid while the coffee is being brewed.
- Danger of burns! Do not touch hot surfaces with your hands: use the handles and buttons.
- Danger of burns! The keep Warm plate remains hot for a few minutes after the coffee has been brewed. Do not touch it.
- Danger of burns! The surface of the heating element remains hot after use. Do not touch it.
- Do not use the drip coffee machine or parts of it with parts or accessories made by other manufacturers.
- Only use original spare parts. The use of spare parts not approved by the manufacturer could lead to fires, electric shocks or personal injury.
- Only place the drip coffee machine on level and dry surfaces.
- Avoid getting the drip coffee machine wet and do not spray liquids onto it. In the event of contact with liquid, immediately switch off the power at the socket or main breaker and dry the appliance thoroughly: Electric shock hazard!
- Do not position the appliance near sinks or taps.
- Do not use harsh detergents or sharp objects to clean the drip coffee machine.
- Do not make any modifications to the appliance.
- Never try to put out a fire or flames with water: turn off the appliance and remove the plug from the socket, and smother the flames with a fire blanket or other appropriate cover.
- Prevent the power cord from coming into contact with sharp edges.
- Never position the appliance above or near gas or electric hob burners when they are hot or in use, inside an oven or near other heat sources.
- Make sure that the lid has been inserted firmly into the top of the jug.
- Do not place the jug on a hob or in a microwave oven.
- Do not place the hot jug on cold or wet surfaces.
- Do not use the jug if it is damaged or the handle is loose.
- Fill the water tank before putting the plug to the electrical outlet.
- Do not install the appliance in environments in which the temperature is 0°C or less.



1.5 Manufacturer liability

The manufacturer shall not be liable for injuries or property damage caused by:

- Use of the appliance other than that specified
- Failure to read the user manual
- Tampering with any part of the appliance
- Use of non-original spare parts
- Failure to observe the safety instructions

1.6 Identification plate

The identification plate bears the technical data, serial number and brand name of the appliance. Do not remove the identification plate for any reason.

1.7 Disposal



This appliance must be disposed of separately from other waste (Directive 2012/19/EU). The appliance does not contain substances in quantities sufficient to be considered hazardous to health and the environment, in accordance with current European directives.

- **Old appliances do not belong in household waste!** To comply with current legislation, old appliances, on reaching the end of their useful lives, should be taken to a disposal facility where they can be sorted. This allows precious materials from old appliances to be recycled and helps protect the environment. For further information, contact the relevant local authorities or your nearest waste recycling centre.

Our appliances are packed in non-polluting and recyclable materials.

- Take these packing materials to the appropriate recycling centre.



Plastic packaging Danger of suffocation

- Do not leave the packaging or any part of it unattended.
- Do not let children play with the plastic bags.



Electrical voltage Danger of electrocution

- Disconnect the mains supply.
- Unplug the appliance.



Description

2 Description

2.1 Product description

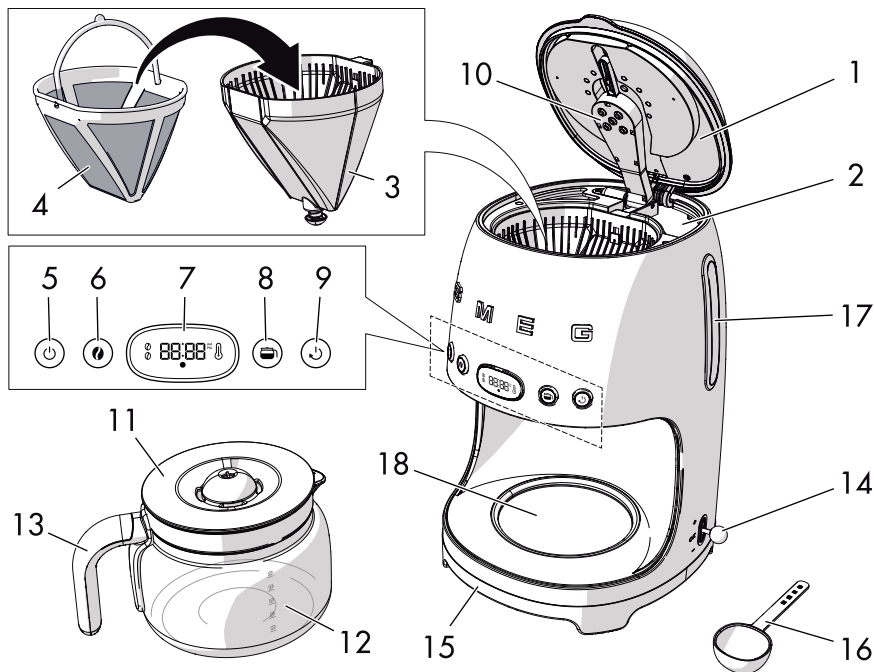

Drip coffee machine

- | | |
|---------------------------------------|---|
| 1 Lid | 10 Boiler outlet |
| 2 Water tank (1.4 litres) | 11 Jug lid |
| 3 Filter holder with anti-drip system | 12 Jug (10 cups) |
| 4 Permanent filter | 13 Jug handle |
| 5 ON/OFF button | 14 Time / timer setting lever |
| 6 AROMA setting button | 15 Base and non-slip feet |
| 7 Time / settings display | 16 Scoop |
| 8 4 CUPS function button | 17 Water tank level indicator (max. 1.4 litres) |
| 9 AUTO START button | 18 Keep Warm plate |



3 Use

3.1 Before first use

1. Remove any labels and stickers from the drip coffee machine.
2. Thoroughly wash and dry the components of the drip coffee machine (see "4 Cleaning and maintenance").
3. Lift the lid (1) by pulling the tab upwards (2).

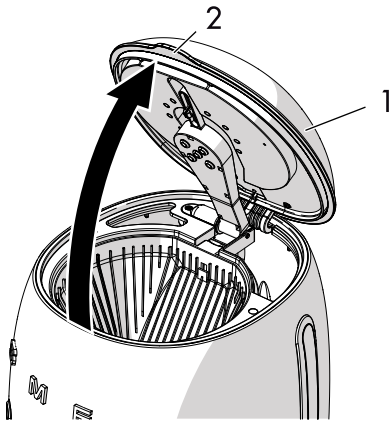

4. Fill the tank (3) with fresh clean water, taking care not to exceed the maximum level shown on the level indicator (4) (1.4 litres).

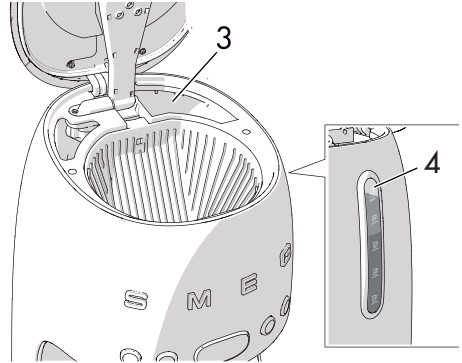

Danger of malfunction

- Do not use the drip coffee machine if there is no water in the tank.
- Only put fresh clean water in the tank.
- Do not use liquids other than water.



To make it easier to fill the tank, make sure that the lid is completely open.



The components intended to come into contact with food are made of materials that comply with the provisions of current legislation.



3.2 First use

1. Plug the appliance into an electrical outlet.
2. The symbols on the display flash.

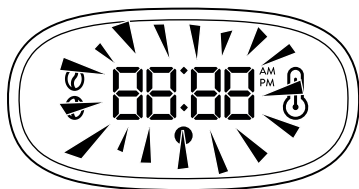

3. Set the time using the lever (1).
4. Set the time by moving the lever up (+) to increase the value or down (-) to decrease it.
5. Confirm the setting by placing the lever in the central position and press (OK).

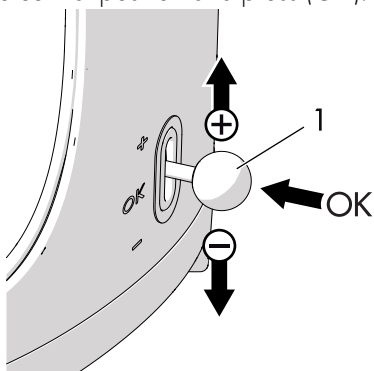

6. Set the minutes following the same procedure.

7. After confirming the minutes setting, the appliance activates the **CLOCK** mode.



When the appliance is switched on for the first time, the default time will be shown in the 12h format indicating AM/PM.

To change the time format, see the "Time format settings menu" section.

3.3 Accessing the settings menu

The appliance allows you to personalise some settings:

- SE01: Set the hour format
- SE02: Set the water hardness
- SE03: Enable / disable sounds

Access the settings menu by pressing the



and buttons simultaneously for 3 seconds.

Press any button to exit from the settings menu.



Time format settings menu

The time format can be modified after the appliance has been switched on for the first time:

1. Access the settings menu and select **SE01**.
2. Move the lever to select the required format (12h or 24h).
3. Move the lever to the central position and press **(OK)** to confirm the setting. The format will flash for 2 seconds: the setting has been saved.



The time format only needs to be set once and the setting is saved.

Modifying the time:

1. Make sure that the required format (12h or 24h) has been set as indicated in the previous section.
2. Keep the lever pressed in the central position for 3 seconds: the display starts to flash.
3. Modify the hours and minutes as indicated in the "3.2 First use" section.

Water hardness settings menu

The water hardness can be set by selecting one of the 3 settings: **HARD**, **MEDIUM** and **SOFT**.

1. Access the settings menu and select **SE02**: The display indicates **HA02** (medium hardness) by default.
2. Move the lever up **(+)** or down **(-)** to set the required setting: **HA01** (soft), **HA02** (medium) and **HA03** (hard).
3. Move the lever to the central position and press **(OK)** to confirm the setting. The selection flashes for 2 seconds: the setting is saved.

Sounds settings menu

The sounds can be disabled as follows:

1. Access the settings menu and select **SE03**.
2. Move the lever up or down until **OFF** appears on the display.
3. Move the lever to the central position and press **(OK)** to confirm the setting. The selection flashes for 2 seconds: the setting is saved.



Use

To re-enable the sounds:

1. Access the settings menu and select SE03.
2. Move the lever up or down until **ON** appears on the display.
3. Move the lever to the central position and press **(OK)** to confirm the setting. The selection flashes for 2 seconds: the setting is saved.

Rinsing of the internal circuits

Rinse the internal circuits after filling the tank:

1. Place the jug (6) on the Keep Warm plate (7) **WITHOUT** putting ground coffee into the filter.

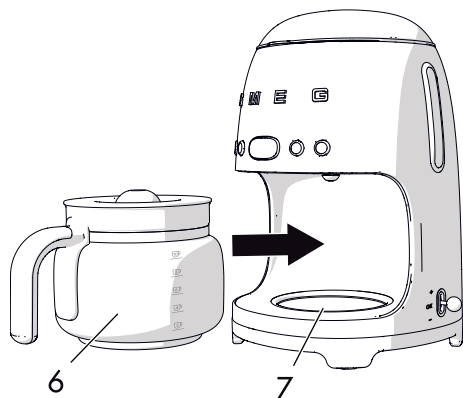

2. Press the **ON/OFF** (power button) button.
3. Wait for the cycle to finish and empty the jug.
4. Repeat the cycle: the appliance is now ready for use.

3.4 How to prepare the coffee

1. Fill the water tank as indicated in section "3.1 Before first use".
2. Lift the lid of the water tank (1) and insert the permanent filter (2) into the filter holder (3).

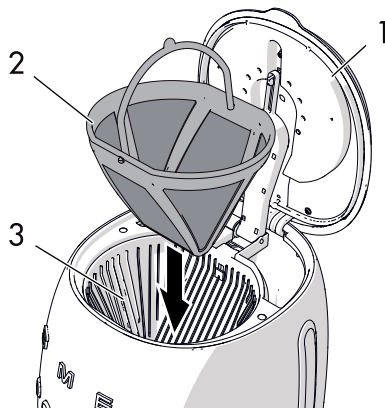

3. Fill with the amount of coffee required, according to the number of cups to be prepared, using the scoop (4) provided.

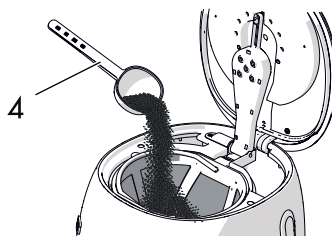

i

The permanent filter allows you to prepare filter coffee without using paper filters. However, according to your own preference, a paper filter #4 can be used instead.

Place the paper filter in the filter holder and add the required amount of coffee.



- One level scoop of ground coffee is approximately equivalent to one cup. However, the amount of ground coffee to be used may vary according to personal taste.
- Use good quality medium ground coffee.

4. Close the lid (1) by lowering the tab.
5. Place the jug (5) with the lid (6) on the Keep Warm plate (7). Make sure that the lid fits perfectly into the anti-drip valve (8).

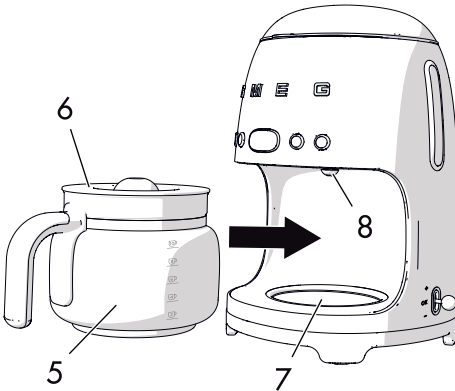

6. Press the ON/OFF (⏻) button to enable the BREW mode: The LED on the ON/OFF (⏻) button lights up and flashes quickly for the entire time the coffee is being brewed.



It is normal for steam to be produced while the coffee is being brewed.



Danger of burns

- Do not open the lid of the water tank while the coffee is being brewed.
7. You can stop the coffee from being brewed at any time by pressing the ON/OFF (⏻) button.





Caution

- Do not open the lid of the drip coffee machine as soon as the brewing cycle has finished. Wait for at least 5 minutes after the coffee has been brewed before opening the lid.
- After 5 minutes, it is possible to remove the filter and fill the tank again to brew more coffee.



Use

i

- Pressing any of the buttons, apart from the **ON / OFF**  button, does not affect the coffee brewing function in any way.
- If the **ON/OFF**  button is not pressed, the coffee continues to be brewed according to the automatic setting to fill the jug completely (10 cups).





- The filter holder and the permanent filter may be hot after the coffee has been brewed. Be careful when removing them.
- The base of the jug may be very hot after the coffee has been brewed. Take care when removing it and make sure that you do not place the jug on a heat-sensitive surface.



KEEP WARM mode

The **KEEP WARM** mode is activated automatically after the coffee has been brewed and keeps the Keep Warm plate on for 40 minutes.

In this way, the coffee will remain hot for 40 minutes after it has been brewed.

In the **KEEP WARM** mode, the LED of the **ON/OFF**  button flashes slowly and the **KEEP WARM**  icon lights up on the display.

The **ON/OFF**  button turns off automatically at the end of the **KEEP WARM** mode.

The **KEEP WARM** mode can be stopped manually at any time by pressing the **ON/OFF**  button: the LED of the **ON/OFF**  button and the **KEEP WARM**  icon turn off.

i

The **KEEP WARM** mode cannot be activated if the **BREW** mode is stopped manually or if the **4 CUPS** mode is active.



Danger of burns



- The Keep Warm plate remains warm after the coffee has been brewed: be careful not to touch it when removing the jug.









Setting the AROMA

This setting allows you to choose between two aroma intensity levels for your coffee: **DELICATE** or **INTENSE**.

The appliance is set by default to

DELICATE: the LED of the aroma button  is off and on the display only the lower coffee bean of the icon  appears selected.

To modify the setting:





1. Press the **AROMA**  button to select **INTENSE**: the LED of the **AROMA**  button lights up and on the display both coffee beans of the  icon appear selected.
2. Press the **AROMA**  button again to select **DELICATE**: the LED of the **AROMA**  button turns off and the upper coffee bean from the icon  appears unselected.

 The required aroma setting is maintained for subsequent brewing cycles.

Using the 4 CUPS function

This function allows you to brew a small amount of coffee, corresponding to approximately 4 cups.

To select the **4 CUPS** function:

1. Press the  button to set it to **ON**: the LED of the **4 CUPS**  function button turns on.
2. Press the  button again to set this function to **OFF**: the LED of the button  turns off.



 If the **4 CUPS** mode has been selected, the **KEEP WARM** mode cannot be activated.







Setting the time for the AUTO START mode

This setting allows the appliance to be programmed to switch on automatically to brew the drip coffee at a time selected by the user.

To set the time at which the appliance switches on automatically, proceed as follows:

1. Make sure that the time displayed is correct. Otherwise, set the correct time as described in section "3.2 First use".
2. Press and hold the  button for 3 seconds to set the automatic start time mode **AUTO START**: The LED of the  button and the time display (HH:MM) start to flash.
3. Move the lever up (+) or down (-) to set the time.
4. Confirm the time by moving the lever to the central position and press **(OK)**.
5. Once set, the time for the **AUTO START** function will be saved automatically and will be used until it is modified.

AUTO START mode

1. Press the **AUTO START**  button to start the **AUTO START** mode: the LED of the **AUTO START**  button will light up and the hours and minutes of the set start time for brewing the coffee will flash for a few seconds on the display. Then the current time will then be displayed.
2. Press the **AROMA**  button to select the intensity of the coffee required for the **AUTO START** mode. If necessary, depending on the quantity to be brewed in **AUTO START** mode, press the **4 CUPS**  function button to memorise the function.
3. The appliance remains in **AUTO START** mode until the pre-set time. The brewing cycle starts automatically.
4. Press the **AUTO START**  button at any time to exit from the **AUTO START** mode.



4 Cleaning and maintenance

4.1 Instructions



Improper use
Danger of electrocution

- Unplug the drip coffee machine before cleaning it.
- Do not immerse the drip coffee machine in water or other liquids.
- Allow the drip coffee machine cool down before cleaning it.



Improper use
Risk of damage to surfaces

- Do not use steam jets to clean the drip coffee machine.
- Do not use cleaning products containing chlorine, ammonia or bleach on parts with metal surface finishes (e.g. anodised, nickel- or chrome-plated).
- Do not use abrasive or corrosive detergents (e.g. powder products, stain removers and metallic scourers).
- Do not use rough or abrasive materials or sharp metal scrapers.

4.2 Cleaning the drip coffee machine

To keep the outer surface of the coffee machine in good condition, it should be cleaned regularly after use. Let the appliance cool down first. Clean with a soft, damp cloth.

4.3 Cleaning the drip coffee machine components

Cleaning the permanent filter and the filter holder

1. Lift the tab of the lid (1) and pull the permanent filter (2) upwards and then the filter holder (3).

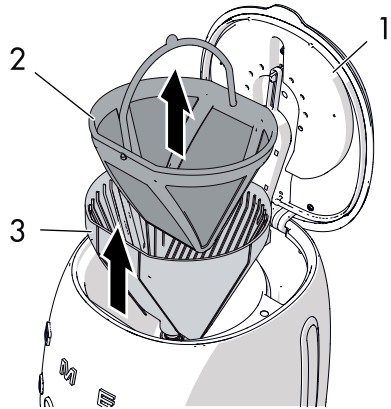

2. Clean the permanent filter and the filter holder, removing any residues of coffee.
3. Rinse the filter and the filter holder under tap water and dry thoroughly.



The permanent filter and the filter holder can be washed in a dishwasher.



Cleaning the jug

1. Empty the jug after each use to prevent staining caused by residues of coffee.
2. Wash the jug in hot, soapy water using a soft brush.
3. Rinse and dry thoroughly.



Risk of damaging the jug







- Do not wash the jug in a dishwasher as it could become permanently damaged.

4.4 Descaling

Depending on the water hardness setting, the appliance automatically indicates when descaling has to be carried out.

The **DESCALING**  icon starts to flash on the display to warn the user that a descaling cycle should be carried out.

To start the descaling cycle:

1. Pour water and the descaler into the water tank.
2. Press the **ON/OFF**  and **AUTO START**  buttons simultaneously for 5 seconds to start the **DESCALING** cycle: the LEDs of the **ON/OFF**  and **AUTO START**  buttons flash and the **DESCALING**  icon flashes until the end of the cycle.
3. At the end of the cycle, the display reverts to **CLOCK** mode and the **DESCALING**  icon disappears from the display.



4. Rinse the appliance by operating it with just water for at least 2 cycles, filling the tank to its maximum limit (1.4 litres).



Caution

- Coffee can be brewed even if the **DESCALING** alarm is active.
- Carry out a descaling cycle when prompted to do so by the appliance.
- **Limescale deposits can prevent the appliance from working correctly, especially if the water is very hard.**



- Regularly descaling the appliance helps to preserve the aroma of the coffee and to keep the appliance in good working order.



Danger of personal injury and damage to the appliance

- The descaler contains acid which can irritate the skin and eyes.
- Follow the manufacturer's instructions and safety warnings on the pack to the letter; they will also tell you what to do in the event of contact with skin or eyes.
- Use descaling products recommended by Smeg to avoid damaging the drip coffee machine.



Cleaning and care

4.5 What to do if...

Problem	Possible causes	Solution
Coffee does not come out	No water in tank.	Fill the tank.
	Scale build-up.	Perform a descaling cycle.
Coffee takes a long time to be dispensed	Scale build-up.	Perform a descaling cycle.
The coffee has an acidic taste	Possible stagnation of coffee in the circuits.	Rinse as described in section "4.4 Descaling".
The drip coffee machine overflows	The filter is not positioned correctly.	Insert the filter correctly in the filter holder.
	The jug is not positioned correctly on the base.	Make sure that the jug is positioned correctly under the boiler outlet.
	There is no lid on the jug.	Place the lid on the jug.
	Excessive amount of coffee.	Place up to a maximum of 5 level scoops of ground coffee into the permanent filter.
	Coffee is too finely ground.	Use ground coffee for drip coffee machines.

Cleaning and care



Problem	Possible causes	Solution
---------	-----------------	----------

Only water comes out of the drip coffee machine

No ground coffee in the filter.

Put the required amount of ground coffee into the filter.

EN



If the problem has not been resolved or in the case of other types of fault, contact your local technical support centre.