

Kenmore

FREEZER OWNER'S MANUAL

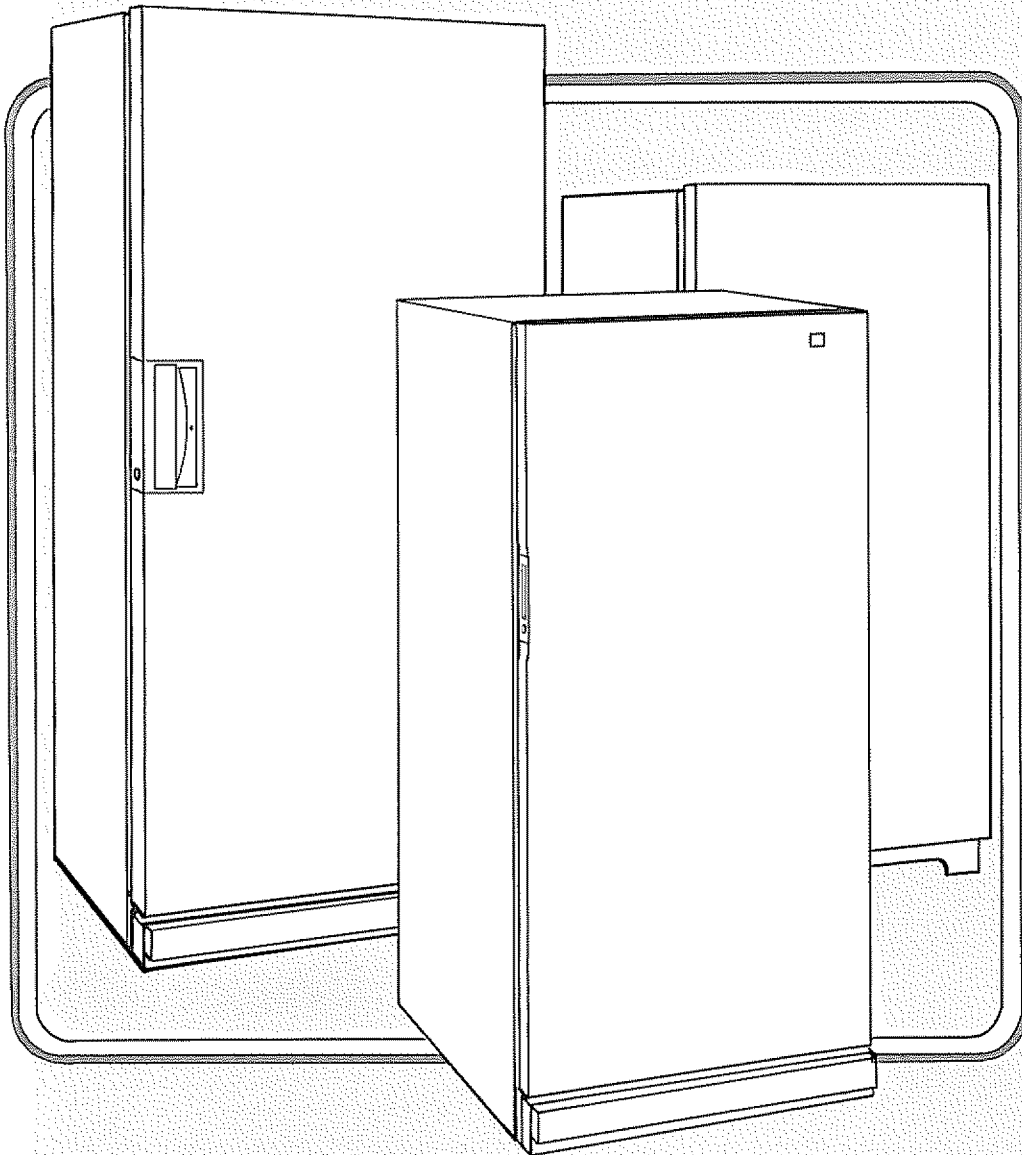

Safety First

Unused or abandoned freezers are still dangerous . . . even if they "just sit in the garage a few days." If you are getting rid of your old freezer, do it safely. Please read the included safety instructions from the Association of Home Appliance Manufacturers.

HELP PREVENT ACCIDENTS

CONTENTS

Safety First.....	Front Cover
If Door Must Be Removed.....	2
Install It.....	2
Level It.....	2
Ground It.....	2
Adjust It.....	3
Start It.....	3
Features.....	3-4-5
Before Calling for Service.....	6
Defrost It/Quick Defrost.....	7
Clean It.....	7
Energy Savings Tips.....	7
Vacation and Moving Care.....	7
Warranty.....	Back Cover

If Door Must Be Removed

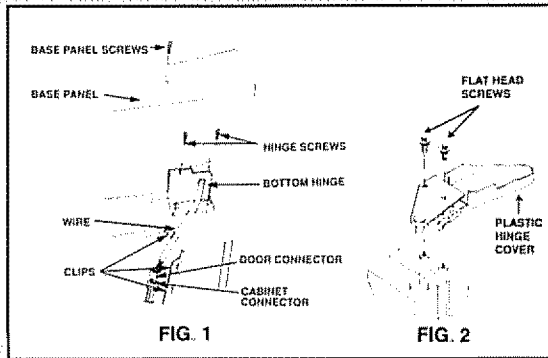

WARNING: If freezer is plugged in, unplug the electrical cord plug from wall outlet.

- Lay freezer on its back on a throw rug.
- (Fig. 1) Remove base panel by unscrewing 2 screws from front of base panel. Remove wire from clips on bottom of cabinet.
- Unplug connector by holding the cabinet connector in place and pulling door connector out, then remove the two screws from the bottom hinge.
- (Fig. 2) Lift up plastic hinge cover and fold back. It is very important that a screwdriver be used both to loosen and retighten the flat head screws on the top hinge, to insure a secure assembly and prevent hinge slippage.
- Remove the top hinge from cabinet, and lift the door off the cabinet.

To replace door, reverse above order.

Install It

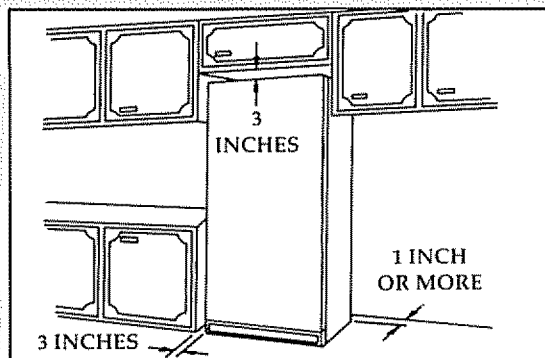

Allow three inches of air space on all sides of the freezer.

- Keep away from flammables, such as gasoline.
- The floor must support the weight of the freezer when fully loaded.
- Keep away from an oven or other heat source. Preferably locate in an area below 100°F.

Level It

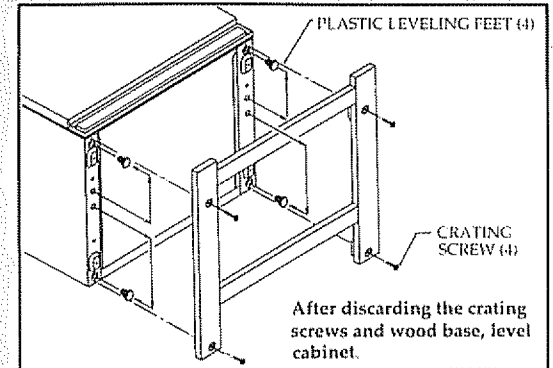

To Level:

1. Screw leveling feet in as far as possible.
2. Carefully set cabinet upright and move into position.
3. Adjust leveling feet as required to level cabinet.

The front leveling feet on upright models only should be raised just enough so the door closes easily when opened about halfway.

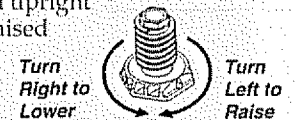

Ground It

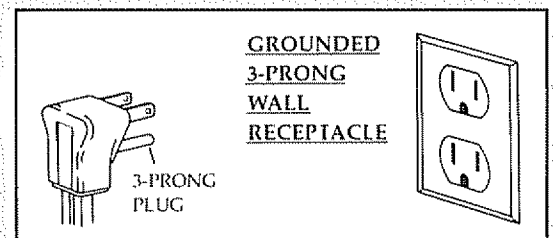

DO NOT REMOVE GROUND PLUG UNDER ANY CIRCUMSTANCES. DO NOT USE AN EXTENSION CORD.

For your safety and protection, the Kenmore freezer is equipped with a special three-terminal type grounding plug on the electrical cord. It must be plugged into its own properly grounded three-prong outlet-115 volt, 60 Hertz, protected with a 15 amp time delay fuse or circuit breaker.

Do not plug the freezer into an outlet controlled by a wall switch or pull cord which might be turned off accidentally.

If the electrical outlet you intend to use will not accept the three-prong plug, or if you are not sure the outlet is adequately grounded, you should have a properly grounded three-prong outlet installed according to the National Electrical Code by a qualified electrician.

Never unplug your freezer by pulling on the cord. Always grip the plug firmly and pull straight out from the receptacle.

Adjust It

Ice cream is a good indicator for adjusting freezer temperatures. Ice cream should be firm. If it is too soft, turn the cold control to a higher number. If ice cream is too hard and brick like turn the cold control to a lower number. After a few days you may want to "fine tune" the cold control for the best temperature.

Features

See pages 4 & 5 for features on your model.

Start It

COLD CONTROL LOCATION

The cold control has been factory pre-set to No. 1 position which should provide satisfactory food storage temperatures. The control knob is adjustable to provide a range of temperatures for your personal satisfaction. The knob is located inside the freezer on the right side. Allow several hours for temperatures to stabilize after adjusting.

NOTE: Do not freeze more than 3 pounds of unfrozen food per cubic feet of space. Add more after first load is frozen.

Power Light

WARNS OF ANY UNKNOWN POWER FAILURE

If light is out, quickly check:

- Power failure
- Disconnected power cord
- Signal light burned out

NOTE: POWER SIGNAL LIGHT SHOWS POWER TO FREEZER ONLY.

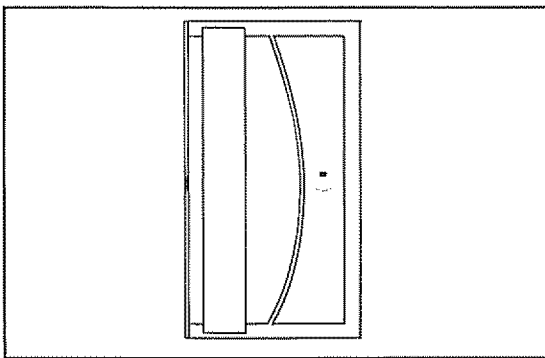

Security Lock

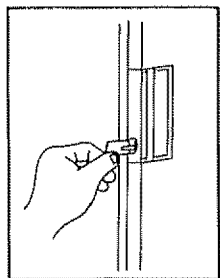

Key pops out for security – store in safe place. To lock or unlock the freezer you must push the key in the lock while turning. The lock is spring loaded so the key cannot be left in the lock.

Interior Light

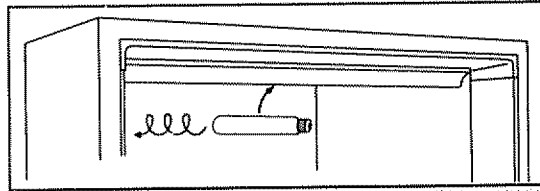

- In case of light failure.
- Turn cold control off.
- Unplug power cord at wall.
- Replace bulb with 25W appliance bulb, which can be purchased through a Sears Service Center.
- Plug in freezer and turn on.

Textured Steel Door

Helps hide smudges and fingerprints.

Door Closer

Located in your bottom hinge.
Never needs cleaning or adjusting.

Removable Freezer Basket and Trivet

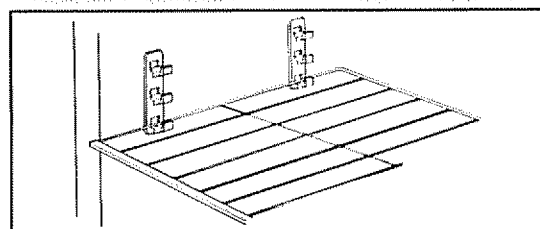
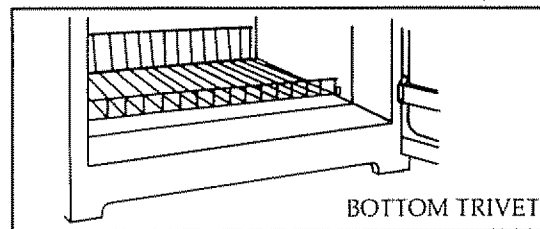
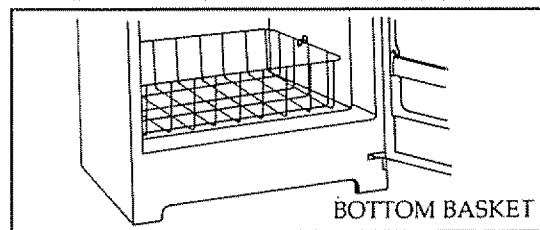

Three position adjustable shelf can be moved to any one of three positions for larger or smaller packages.

MODEL 23738 (17.0 cu. ft.)

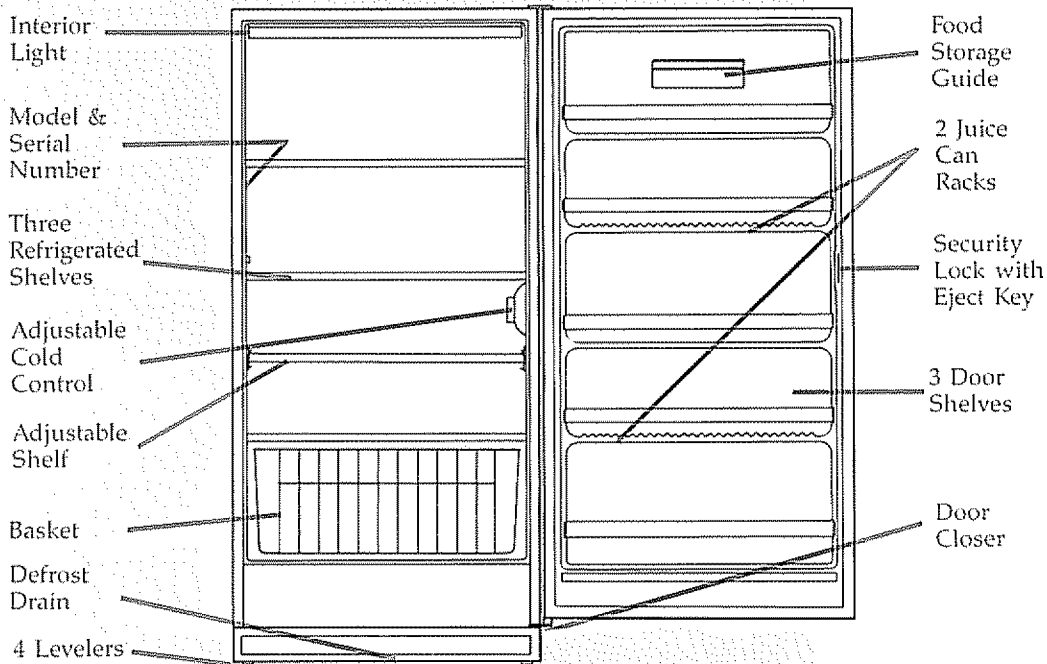

Almond Exterior
 Handle with Power Light
 Magnetic Door Gasket

Energy Efficient Foam Insulation
 Textured Steel Door and Cabinet
 Hose Adapter

MODEL 23228 (11.7 cu. ft.)

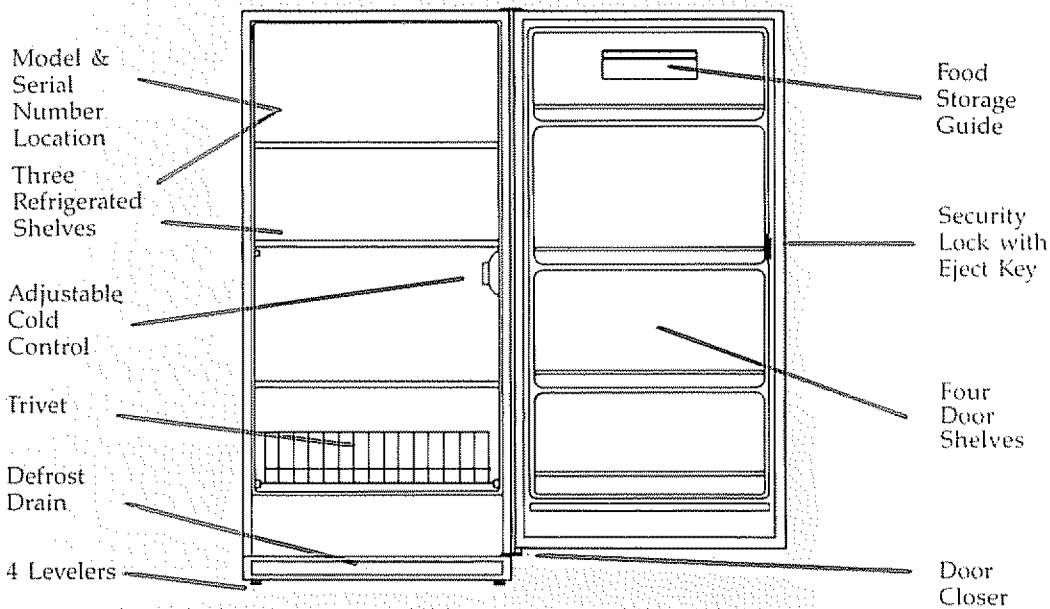

Almond Exterior
 Handle with Power Light
 Magnetic Door Gasket

Energy Efficient Foam Insulation
 Textured Steel Door and Cabinet
 Hose Adapter



MODEL 23431/23438 (14.0 cu. ft.)

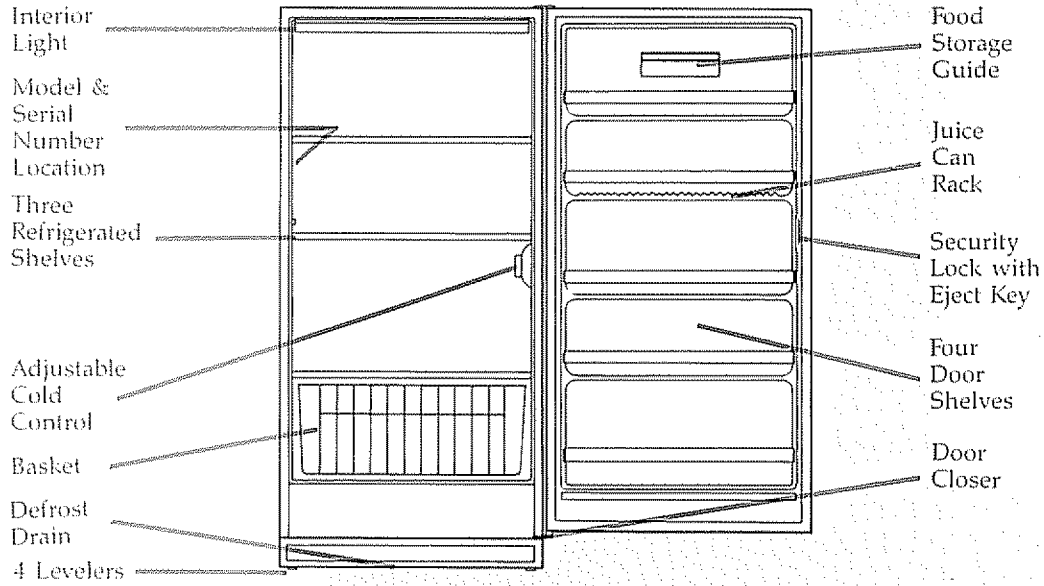

White/Almond Exterior
Handle with Power Light
Magnetic Door Gasket

Energy Efficient Foam Insulation
Textured Steel Door and Cabinet
Hose Adapter

MODEL 23411 (14.0 cu. ft.)

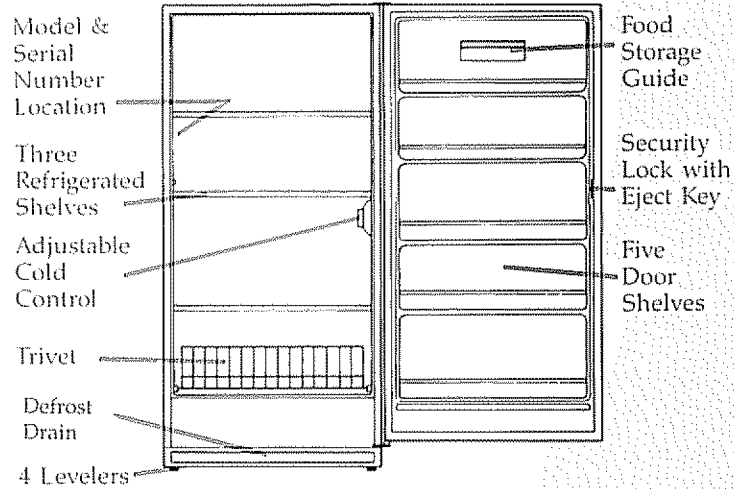

White Exterior
Magnetic Door Gasket

Energy Efficient Foam Insulation
Textured Steel Door and Cabinet

MODEL 23918 (8.7 cu. ft.)

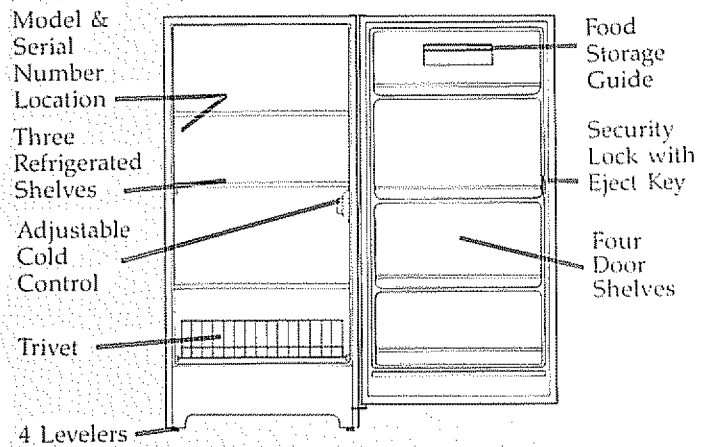

Almond Exterior
Magnetic Door Gasket

Energy Efficient Foam Insulation
Textured Steel Door and Cabinet



BEFORE CALLING FOR SERVICE

Runs Too Long Or Appears Warm

- See if Cold Control is set colder than necessary
Remember: the higher the number, the colder the temperature
- Be sure food packages are not keeping door from closing tightly.
- Unfrozen food may cause the freezer to run longer than normal
- Room temperature may be too warm. If freezer temperature keeps going up, call Sears Service right away

Frost Forms Unevenly

- Too many door openings in high humidity conditions
- Limit length of door openings when possible.
- Keep packages from blocking door.
- Door not sealing properly (See page 2, level it).
- Due to natural air flow patterns, a vertical upright freezer will often form more frost on the upper shelf

Too Noisy

- The refrigerant will gurgle
- The compressor will click on and off
- You may even hear it hum or vibrate
These are all normal sounds of your freezer at work

Exterior Wall Feels Warm

- This is a normal operating condition

Moisture Collects On Outside

- Freezer may be in path of hot humid air. Freezer temperature may be too cold
- Reset Cold Control to smaller number
- Some moisture is normal in hot, humid weather

Power Fails

- Short time failure (less than 24 hours): Frozen food will keep safely for about 24 hours if freezer door is kept shut and room air does not exceed 80°F
- Long time failure (more than 24 hours): Take food to frozen food locker or place dry ice inside freezer (See Yellow Pages under "Dry Ice")

DRY ICE REQUIREMENTS PER 24 HOURS

FREEZER SIZE	ROOM TEMPERATURE
	70° to 100°
5 to 10 cu ft	20 to 25 lbs
10 to 15 cu ft	25 to 40 lbs
15 to 20 cu ft	40 to 50 lbs
20 to 30 cu ft	50 to 60 lbs
30 cu ft or over	60 to 70 lbs

WARNING: DRY ICE WILL BURN YOUR SKIN;
WEAR HEAVY GLOVES.

Doesn't Run

- Check outlet for power.
- Be sure Cold Control is "ON"

Door Difficult To Open

In order to ensure that your frozen food is maintained at a safe and constant low temperature, your freezer has a magnetic strip in the gasket to maintain an airtight seal.

This seal is so effective that the simple action of closing the door will almost instantly create a vacuum as the warm air quickly cools.

This vacuum will leave in a minute or two. If you must reopen the door sooner, try peeling the gasket open with fingertips as door is pulled open.

IF THE DOOR GASKET DOES NOT SEAL:

Step 1: Loosen all door panel screws around edge of door.

Step 2: If equipped, adjust the two screws on the bottom edge of the door.

Follow: Illustration A if the door does not seal on the top.

Illustration B if the door does not seal on the bottom.

After adjustment, retighten all of the door panel screws.

Step 1

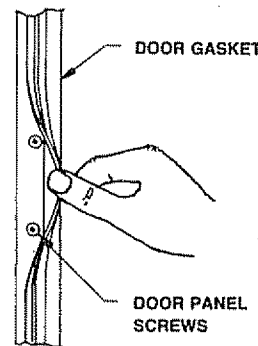

Step 2

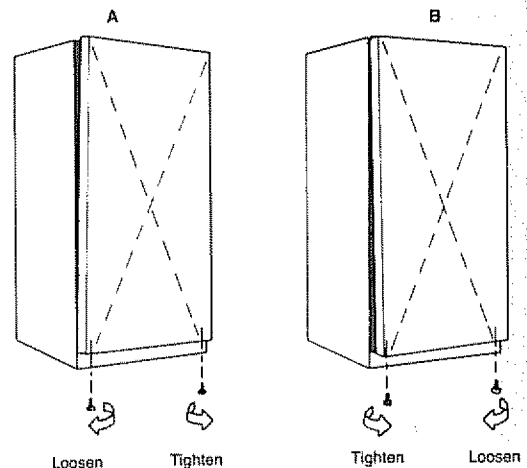

Defrost It

You should defrost your freezer when the frost becomes 1/4" thick. Further accumulation will reduce operating efficiency. How often you have to defrost depends on the type and amount of food you freeze, the temperature and humidity and the number of times you open and close the freezer. (The period between defrosting can be extended by scraping frost every so often with a plastic scraper.)

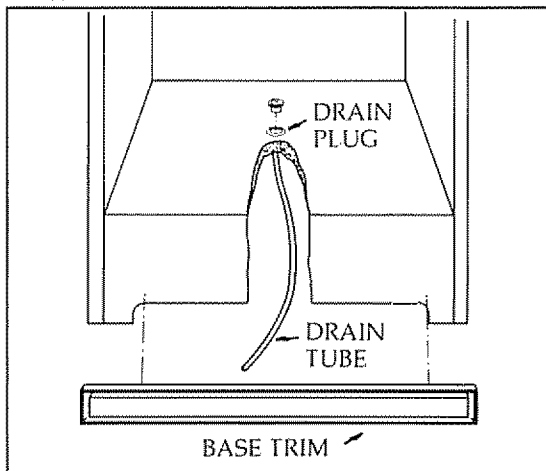

Here is how:

- Turn cold control off.
- Unplug power cord at wall.
- Remove all frozen food and wrap in several thicknesses of newspaper and place in boxes.
- Remove drain plug.
- Unscrew base trim.
- The drain tube is located near the left center under the freezer. The defrost water can be collected in any suitable shallow pan.
- Leave door open and wait for frost to melt.
- On models without a defrost drain, place towels or newspapers on the freezer bottom to catch the frost. The frost will loosen and fall. Remove paper and/or towels.

Quick Defrost

(Tips to speed defrosting)

- Place towel in bottom of freezer (over defrost drain) to absorb excess moisture.
- Place pans of hot water on refrigerated shelves.
- Wipe with a cloth or sponge (do not use sharp objects or electric defrost devices).
- After defrost - plug in freezer.
- Turn cold control back to original position.

Clean It

- Unplug power cord at wall.
- While defrosting the freezer, take time to clean the inside thoroughly.
- Use a mild solution of baking soda (2 tablespoons) in warm water (1 quart).
- Clean all inside surfaces.
- To protect exterior-use a good quality automotive wax.

Energy Saving Tips

- Close door as soon as you can.
- Reduce door openings.
- Check door to make sure it has shut tightly.
- Adjust cold control. (See Pages 2, 3 Start It, Adjust It.)
- Do not put hot foods in freezer. Let hot food cool to room temperature before placing in freezer.
- Keep freezer away from stove, or other heat sources. A cool dry place is recommended.

Vacation?

- For a short vacation arrange for someone to inspect it at regular intervals.
- For longer periods of time you may wish to remove food, unplug your freezer, defrost, clean thoroughly and block door open to prevent odor and/or mildew growth.

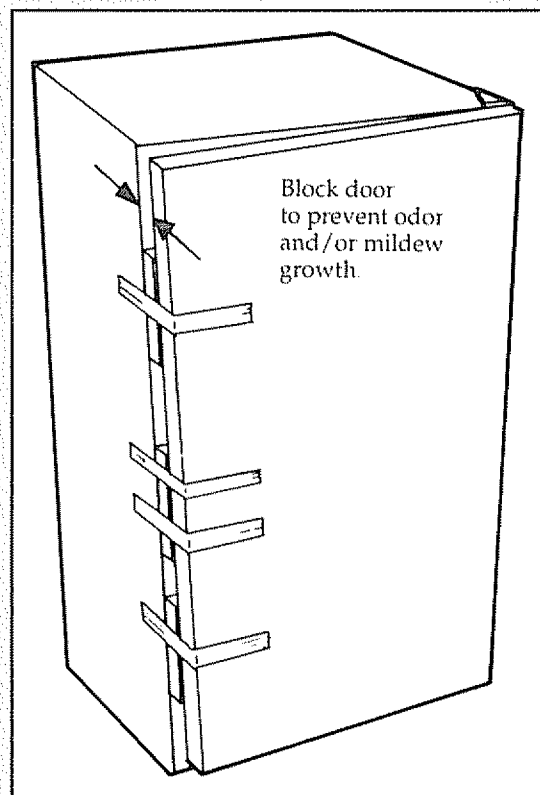

Moving?

- Remove all food and then defrost.
- Clean thoroughly and allow to dry (otherwise odors will build up.)
- Tape all interior loose baskets securely in position.
- Tape door securely shut.
- Ship in upright position - never on back.



FULL ONE YEAR WARRANTY ON FREEZER

For one year from the date of purchase, when this freezer is operated and maintained according to instructions attached to or furnished with the product, Sears will repair this freezer, free of charge, if defective in material or workmanship.

FULL FIVE YEAR WARRANTY ON SEALED REFRIGERATION SYSTEM

For five years from the date of purchase, when this freezer is operated and maintained according to instructions attached to or furnished with the product, Sears will repair the sealed system (consisting of refrigerant, connecting tubing and compressor motor), free of charge, if defective in material or workmanship. The above warranty coverage applies only to freezers which are used for storage of food for private household purposes.

WARRANTY SERVICE IS AVAILABLE BY CONTACTING THE NEAREST SEARS SERVICE CENTER/DEPARTMENT IN THE UNITED STATES. This warranty applies only while this product is in use in the United States.

Food Loss Coverage Limitation

If promptly reported to your nearest Sears store or Service Center, Sears will reimburse you up to a total of \$100.00 for the value of food, as verified by Sears, lost while stored in the freezer when used for private household purposes as a result of:

- 1 Defects that occur during the first year following date of purchase
- 2 Failure of the sealed system (including refrigerant, connecting tubing and compressor motor) due to defects that occur during the second through fifth year after purchase. If freezer is used for other than private household purposes, Sears will not be responsible for any food loss. Food losses resulting from other than the above stated defects, such as: natural spoilage, power interruption, inadequate power, manual disconnect of power supply, fire damage, water damage, theft, etc., are beyond our control and are not covered by Sears. Some states do not allow the exclusion or limitation of incidental or consequential damages, so the above limitation or exclusion may not apply to you. This warranty gives you specific legal rights and you may also have other rights which vary from state to state.

SEARS ROEBUCK AND CO. D/817WA, Hoffman Estate, IL 60195

WE SERVICE WHAT WE SELL

"We Service What We Sell" is our assurance to you that you can depend on Sears for service, and Sears service is nationwide.

Your Kenmore has added value when you consider that Sears has a service unit near you, staffed by Sears trained technicians . . . professional technicians specifically trained on Sears appliances, having the parts, tools and equipment to ensure that we meet our pledge to you . . . "We Service What We Sell."

SHOULD YOU EVER NEED SERVICE, REMEMBER . . . TO GIVE THE COMPLETE TEN-DIGIT MODEL NUMBER AND COMPLETE SERIAL NUMBER OF YOUR KENMORE FREEZER.

TO FURTHER ADD TO THE VALUE OF YOUR KENMORE FREEZER, BUY A SEARS MAINTENANCE AGREEMENT.

Sears Kenmore appliances are designed, manufactured and tested for years of dependable operation. Yet, any modern appliance may require service from time to time. The Sears warranty plus the Sears maintenance agreement provide protection from unexpected repair bills.

CONTACT YOUR SEARS SALES PERSON OR LOCAL SEARS SERVICE CENTER TODAY AND PURCHASE A SEARS MAINTENANCE AGREEMENT.

Record in the space below the model number and serial number of this freezer. They are located inside upper left side of freezer.

Model Number **253.** _____ Serial Number _____
Date Purchased _____

