

Instruction Manual

Refrigerator

Model

HRTN6443S HRTN6443SXAU
 HRTN6443SBBKAU

HRTN6408S HRTN6408SPWHAU
 HRTN6408SPSVAU

HRTN6379S HRTN6379SXAU
 HRTN6379SBBKAU

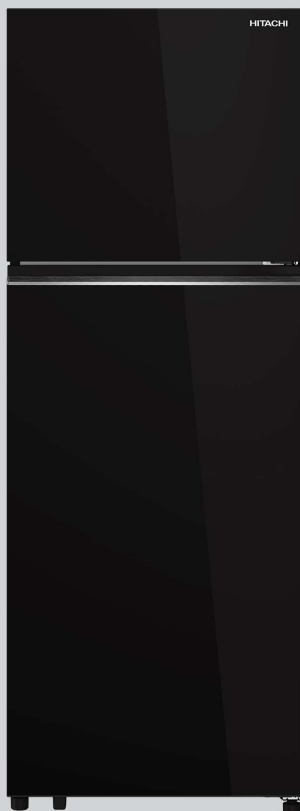

Thank you very much for purchasing the Hitachi refrigerator.
Before installation and usage, please read the user's guide carefully
for the correct usage.

Maintenance work must only be carried out at the workshop
by well-trained maintenance workers.

HITACHI

Content

Preparation for Use

Warnings and Caution for Safety.....	2
Preparations before Use.....	4
■ Installation.....	4
■ Before Use.....	4
■ Optimal Food Storage.....	4

Operation

Location of Food Storage.....	4
Operating instructions.....	5
■ Temperature Control.....	5
■ Quick Freeze/Quick Cool/Eco Mode.....	5
■ How to use temperature control 9 steps.....	6
■ Freezer Compartment.....	6
■ Refrigerator Compartment.....	6
Other Function.....	7
■ Door Alarm.....	7

Maintenance

Care and Maintenance.....	7
■ Cleaning.....	7
Troubleshooting.....	8
Dew of Frost is generated.....	9
Service Center.....	10

For household use only

R600a
Refrigerant

Warning and Caution for Safety



To avoid harm to the user, other persons or damage to property, please read and follow the warnings and cautions below and those given throughout this manual.

The following warnings and cautions are categorized by the level of possible harm or damage that may occur from ignoring directions.

This symbols are shown as below clearly showing the significance of directions.

 WARNING	This pictograph indicates "There is a high possibility of serious injury or death, if ignored".
 CAUTION	This pictograph indicates "There is a high possibility of injury or damage to property, if ignored"

■ This refrigerator use flammable refrigerants. The symbol column below states the precautions on flammable refrigerants.

The symbols below are examples.	
	This symbols is an alert mark.
	This symbols indicates "prohibited".
	This symbols indicates "necessary".





This symbol denotes the precautions on flammable refrigerants.

WARNING

When you install ... To avoid fire, electric shock, and injury.

- Do not install the refrigerator in a place where it may come in contact with water. 
- Do not install the refrigerator in a place exposed to rain.
 - This may impair electricity insulation and cause electric shock or fire.







Power Cord and Power Plug ... To avoid fire, electric shock.

- Do not connect the wall outlet whose power capacity is less than the refrigerator's. Also, do not use power sources that are not a rated voltage.
 - If a power source is shared with other appliances using double or multipoint adapters, the adapter may heat up beyond the normal level and cause fire.
 - Do not locate multiple portable socket-outlets or portable power supplies at the rear of the appliance.
- Do not use a damaged or loose power plug or power outlet. This may cause fire or electric shock. 
- Do not cut, bend, fold the power cord to avoid fire and electric shock.
 - When positioning the appliance, ensure the supply cord is not trapped or damaged.
- Be sure to unplug the power plug before maintaining the refrigerator.
 - Be sure to hold the power plug to unplug.
- Connect the power plug firmly to a power outlet with the cord running down.
 - Connection of the power plug with the cord running up could apply stress on the cord and cause electrical short or overheat, which could result in electrical shock or fire.
 - Incomplete connection of the power plug could result in electrical shock or fire due to heat.
- If the supply cord is damaged, it must be replaced by the manufacturer, its service agent or similarly qualified persons in order to avoid a hazard. 
- Clean the dust on the power plug frequently with dry cloth.
 - Unplug the power plug and wipe it with dry cloth.
 - An insulation failure due to moisture or when dust collects on the power plug may cause fire.
- Do not insert or remove the power plug with wet hands. 

During daily use ... To avoid fire, electric shock.











- Do not splash water on or inside the refrigerator.
 - This may impair electricity insulation causing electric shock or fire.
 - This may also cause gas leakage because of pipe rust.
- This appliance is not intended for use by persons (including children) with reduced physical, sensory or mental capabilities, or lack of experience and knowledge, unless they have been given supervision or instruction concerning use of the appliance by a person responsible for their safety.
- Do not hang on the doors or step up on the various compartments.
 - Injury may be caused by the refrigerator tipping over or hands getting caught in door.
 - Do not enter in the refrigerator.
- Do not disassemble, repair, or modify the refrigerator by yourself.
 - Please consult with a retailer or Hitachi Service Center if any repair is required.
- Ether, liquid propane gas, solvent, aerosol cans, etc. which is volatile cannot be stored in this refrigerator.
 - Do not store anything that are generate heat or fire spark inside the refrigerator.
- Do not put water containers or foreign articles on the top of the refrigerator.
 - Opening and closing doors etc. may cause the articles on the top of the refrigerator to fall down, resulting in injury.

! WARNING

-  Do not damage the refrigerant circuit.
 - If there the damage to the refrigerant pipe happened, stay away from the refrigerator and avoid using fire and electrical appliances.
 - And, open windows to ventilate and contact retailers or Hitachi Service Center.
-  Do not use electrical appliances inside the food storage compartments of the appliance, unless they are of the type recommended by the manufacturer.
-  In an event of a flammable gas leak, do not touch the refrigerator and open windows for ventilation.
 - Sparks from points of electrical contacts such as door switches may ignite explosions causing fire or a burn.
-  Do not use the refrigerator in the atmosphere of flammable gas.
-  Do not make an impact on the glass-made doors or shelves.
 - They are made of tempered glass, however, an excess impact may be result in breakage and is dangerous.
-  If you find something wrong with the refrigerator, immediately unplug and consult with the retailers or Hitachi Service Center.





When discarding the refrigerator.





-  When discarding the refrigerator, remove the door gaskets.
 - To avoid a risk of an infant or child to be entrapped inside.

-  Medicines, chemicals, research and experimental substances should not be stored in the refrigerator.
 - Substances that require precise conditions for storage cannot be stored in a domestic refrigerator.
-  Do not use mechanical devices or other means to accelerate the defrosting process, other than those recommended by the manufacturer.
-  Children should be supervised to ensure that they do not play with the appliance.
 - Children getting inside may not be able to get out.
-  Cleaning and user maintenance shall not be made by children without supervisor.
-  This appliance can be used by children aged from 8 years and above and persons with reduced physical, sensory or mental capabilities or lack of experience and knowledge if they have been given supervision or instruction concerning use of the appliance in a safe way and understand the hazards involved.
-  Children shall not play with the appliance.
-  Children aged from 3 to 8 years are allowed to load and unload refrigerating appliance.
-  Keep ventilation openings in the appliance enclosure or in the built-in structure clear of obstruction.
-  The appliance is intended to be placed against a wall with a free distance not exceeding 75 mm.
-  Follow the instructions of your region when discarding.
 - This refrigerator uses R-600a for the refrigerant and cyclopentane for the blowing agent of the urethane heat insulation.



! CAUTION



During daily use ...To avoid illness and injury.

-  Do not put bottles, etc. forcibly in the door pockets.
 - This may cause bottles to drop down or door pockets to come off.
-  Do not store food which smells or food whose color is changed abnormal.
 - Such an action may cause diseases.
-  Food and containers inside the freezer compartment should not be touched with wet hands.
 - This may cause frost injury. (Especially in case of metal items.)
-  Do not hold the top, bottom and side of the doors when closing them.
 - This may result in your fingers being caught by the door edge.

-  Do not have food items protruding over the front edge of each shelf.
 - Doors may not be closed properly or the door pockets may drop down. Injury may be caused from items like bottles getting knocked over your feet.
-  Do not store glass bottles in the freezer compartment.
 - Bottles may break by the contents freezing and cause injury.
-  Do not put your hands into the base surface of the refrigerator cabinet.
 - When cleaning, putting your hands near the base surface of the refrigerator may result in injury by thin metal sheets.
-  Do not have your feet too close when opening the door of the refrigerator.
 - When opening the door, your feet may be hit, resulting in injury.

When moving or carrying ... To avoid damaging, wetting, soiling the floor, or to avoid injury.

-  Use the carrying handle when carrying the refrigerator.
 - Hold the carrying handles only. If hold door handles, hands may slip and may cause injury.
 - Carry the refrigerator by at least 4 persons for safety reasons.
 - Carry it with the doors facing upward.
-  Before carrying the refrigerator:
 1. Take out all food items and ice cubes.
 2. Lay a protective sheet or cloth to protect the floor from damage and catch remaining water spilled from the refrigerator.
 3. With a large piece of old cloth underneath, tilt the refrigerator backward to drain water.
 4. Finally carry the refrigerator with the doors facing upward.
 - Secure the doors well with adhesive tapes so they do not open.
 - If transporting in a vehicle, do not load the refrigerator on its side. This could damage the compressor.

-  Do not use door handles when carrying the refrigerator.
-  Never use the carrying handles to hang up with a chain hoist or similar machines.

-  For a floor that may be easily scratched, lay a protective mat, etc..

When replacing lamps (LED) is required.

-  When replacing lamps (LED) is required, please contact your dealer or Hitachi Service Center.

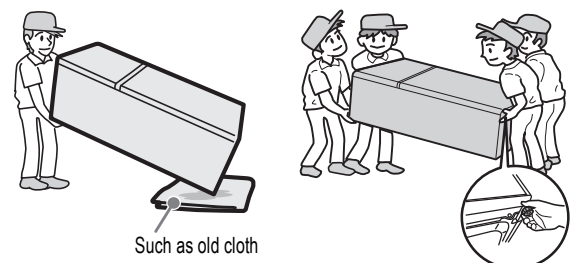

Such as old cloth

Preparations before Use

1 Installation

- 1) Install on a rigid and level floor. Do not use an extra stand.
- 2) Please use this refrigerator between the room temperature of 10°C to 43°C. Sufficient performance may not be obtained, if room temperature is too low or too high.
- 3) Do not install where the refrigerator is exposed to direct sunlight or other heat source.
- 4) Install in an atmosphere which is dry or has air ventilation.
- 5) The refrigerator requires enough air ventilation space around the cabinet to have efficient cooling performance. Space of at least 30 cm over the top, 5 cm at both sides and at rear must not exceed 7.5 cm for proper air circulation is needed.
- 6) Ground the refrigerator to prevent electric shock and noise interference. Always ground this refrigerator when using it in place with high humidity or moisture. (Please consult with retailers or Hitachi Service Center.)
- 7) Make the refrigerator stand horizontally by adjusting the leveling legs (adjustor).
 - Without adjusting the legs, door height may not be level, or there may be abnormal vibration or noises depending on floor conditions. Follow the instructions below.
 - Turn the adjustable legs until they touch the floor firmly.
- 8) When opening the doors, please open carefully until it stop approximate at 130°. Do not over open. Otherwise the door may cause damage.

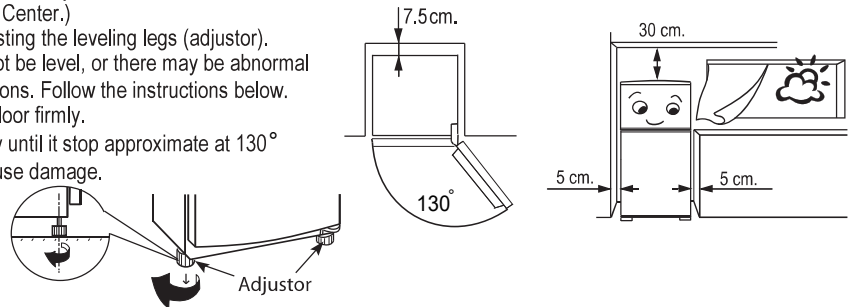
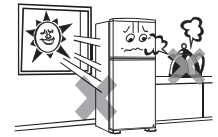
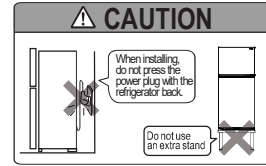

2 Before Use

- 1) After transporting : If Refrigerator has been kept horizontal position for more than 10 minutes for transportation or any other reasons, it should stand upright for more than 1 hour before plugging it in.
- 2) Cleaning inside the refrigerator. Wipe the surface gently with soft cloth.
- 3) Connect the refrigerator to an exclusive wall power outlet. The refrigerator can be connected to an outlet soon after it is installed. Surely use with the rated voltage and exclusive power outlet.
- 4) The compressor will start running in approximately 30 seconds, if inside is not cold.
- 5) Allow enough duration for sufficient cooling before storing food. It may take about 4 hours to fully cool down and could even take about 24 hours when the ambient temperature is high.
- 6) Opening the door for long periods can cause a significant increase of the temperature in the compartments of the appliance.

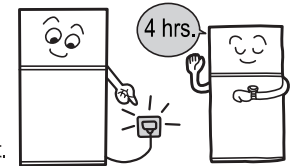

3 Optimal Food Storage

- 1) Keep enough space between food. Several food placed too close together may obstruct the flow of cold air.
- 2) Make food cool enough before putting it in the refrigerator. Putting warm food in the refrigerator raises the inside temperature and wastes electricity.
- 3) Do not block the cold air vent. This will adversely affect the cold air flow and may not keep the temperature inside even. Moreover, it could result in food near the vent freezing.
- 4) Using plastic wrap or sealed containers prevent the food from drying or transition of smells.
- 5) Store raw meat and fish in suitable containers in the refrigerator, so that it is not in contact with or drip onto other food.



Location of Food Storage

Freezer Compartment -20°C ~ -18°C

Freezer Shelves

- Storage of frozen food and ice cream, etc.



Movable Twist Ice Tray

- For ice cube storage made by "Twist Ice Maker"



Refrigerator Compartment

Selectable Zone (see page 6)

Refrigerator
3°C (±2°C)

Chill
0°C (±2°C)

Soft Freeze
-3°C (±2°C)



Refrigerator Shelves (1°C ~ 5°C)

- Storage of side dish, desert, etc.



Freezer Door Pockets -19°C ~ -17°C

Freezer Door Pockets

- Storage of packed small frozen food.
- Not recommended for long storage, because temperature rise caused by door open may occur.



Refrigerator Door Pockets 2°C ~ 6°C

Egg tray

- Storage of eggs (12 eggs)

Refrigerator Door Pockets

- Storage of packed small food and drinks such as juice, milk, etc.



Vegetable Compartment 4°C ~ 7°C

Vegetable Drawers

- Storage of fruits and vegetables.



NOTICE

- Above temperatures are the approximate values in the conditions of outside temperature 32°C, the temperature setting of the refrigerator compartment "Normal", freezer compartment "Normal", while doors being closed and without food storage.
- Door pocket temperatures may be slightly higher than above temperatures.

Operating instructions

1

Temperature Control

This refrigerator control its temperature automatically. Please adjust a temperature control by press the control panel as follows.

	Freezer Compartment	When storing neither frozen food nor ice cream. Cold	For normal use. Normal	When making ice quickly or making frozen food quickly or a surrounding temperature is high and the Freezer compartment is not cold enough. Coldest
		Refrigerator Compartment	For food that doesn't need a lot of coldness. Cold	For normal use. Normal

- Please return the dial to the position of "Normal" after the "Coldest" has been set. Food may be frozen if the "Coldest" is set for a long time.
- If set the dial to the "Cold" side for a long time, the temperature of the food in freezer and refrigerator compartment may rise.

Caution about a refrigerator compartment food freeze.

- When you place the high moisture food and vegetables at the inner part of shelf nearby the cold air vent, they will be frozen. If it is possible, please do not place the high moisture food and vegetables at the inner part of the shelf nearby the cold air vent.
- When food and vegetables become frozen, you can prevent them from being frozen by wrapping or putting them in the case. If they are still frozen, please adjust the temperature by turning the temperature control dial to "Cold".

2

Quick Freeze/Quick Cool/Eco Mode

Quick Freeze : When you want to freeze food or make ice quickly, use this function

Quick Cool : When you want to cool food or drinks quickly, use this function

Eco Mode : Recommend to use this function in case of low storage volume, or a long vacation when the doors are not opened for long time.

Press the "Freezer" button. Hold for 3 sec to Quick Freeze Mode operation, lamp light is on. "Quick Freezing" will be finished automatically in approximately 2 hours.

Quick Freeze

Press the "Refrigerator" button. Hold for 3 sec to Quick Cool Mode operation, lamp light is on. "Quick Cooling" will be finished automatically in approximately 90 minutes.

Quick Cool

Press "Eco Mode" button for Start Energy Saving operation, lamp light is on.

Press "Eco Mode" button again for stop Energy Saving operation, lamp light is off.

Eco Mode

CAUTION

If "Eco Mode" operation is working in high humidity environment, dew may appear on refrigerator surface. Please stop "Eco Mode" operation in this case.

NOTICE

- During "Quick Freeze", priority cooling of the freezer compartment will be done. Thus, try to avoid unnecessary opening and closing the doors not to have a temperature rise of the refrigerator compartment.
- During defrost period, "Quick Freeze" and "Quick cool" operation will stop even though the lamp is on. After finishing defrost period, the operation will restart automatically.
- Please note "Quick Freeze" and "Quick cool" mode will be released after power cut off or unplug.
- In case the compartment temperature rises up, the operation will be back to a normal setting (temporary).
- After a long time operation of "Eco Mode", in some cases, fatty ice cream, etc, may become soft. Please stop "Eco Mode" operation in this case.

Operating instructions

3

How to use temperature control 9 step (Refrigerator compartment/ Freezer Compartment).

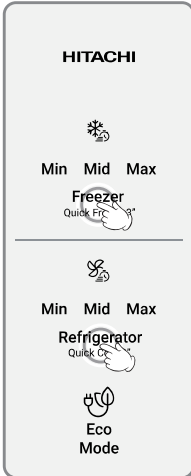

Setting : Open the Refrigerator door before press button "Freezer and Refrigerator" to setting.

Press button "Freezer and Refrigerator" for 5 seconds until 1 "Peep!" sound is heard.

Each time you press the button, the corresponding indicator lamp changes in order shown below (9 steps).

(Lighting Blinking Turned off)

Indication lamp	Min Mid Max	Min Mid Max	Min Mid Max	Min Mid Max	Min Mid Max	Min Mid Max	Min Mid Max	Min Mid Max	Min Mid Max	Min Mid Max
Setting	Cold				Normal					Coldest
Sound	Pi!	Pi!	Pi!	Pi!	PiPi!	Pi!	Pi!	Pi!	Pi!	Pi!

Cancel : Open the Refrigerator door before press button "Freezer and Refrigerator" to cancel.

Press button "Freezer Set and Refrigerator Set" for 5 seconds until 1 "PiPi!" sound is heard.

You can set temperature by normal step (3 steps).

NOTICE

- This function is subjected to change according model type.
- Factory setting, the adjustment temperature by normal step (3 steps).

4

Freezer Compartment

Ice Making

- Take the "Twist Ice Maker" and pour in water up to the full line.
- After ice is made, turn the lever firmly by following arrow and drop the ice into the "Ice Bank".

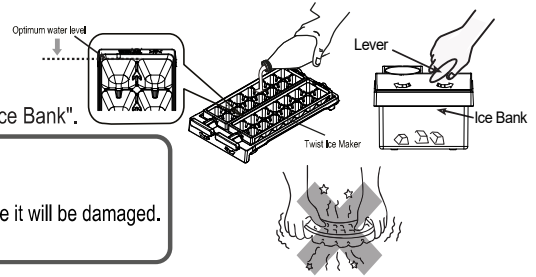

NOTICE

- Do not remove the ice maker with the frame and do not twist it as shown in the picture or else it will be damaged.
- Do not use the "Ice Bank" as an ice maker tray or else it will be damaged.

5

Refrigerator Compartment

Selectable Zone



NOTICE

- Above temperatures are approximate values under the conditions of the door being close and without food storage.

CAUTION

- If you want to store meat or fish longer, please store them in the freezer compartment.
- Be careful, it might be frozen if that food has a lot of moisture.
- When closing the refrigerator door, push the chilled case for close. If you close the door while the chilled case is still pulled out. The chilled case might be broken.
- Meat and fish can be kept fresh before being frozen.

Egg pocket

- It can place 12 eggs also turn the rear side to place the small pocket.

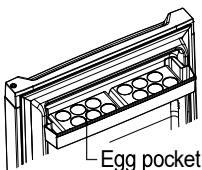

CAUTION

- Be careful, egg might be frozen if that room temperature is too low. In this case, please move the egg tray to the lower pocket.

- There is a temperature control which can adjust the amount of cold air flowing into the drawer.

Set the lever to "Refrigerator" to provide temperature 3°C (±2°C)

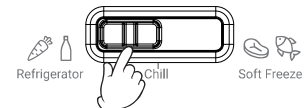

Set the lever to "Chill" to provide temperature 0°C (±2°C)

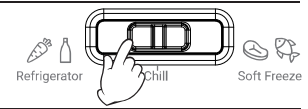

Set the lever to "Soft Freeze" to provide temperature -3°C (±2°C)

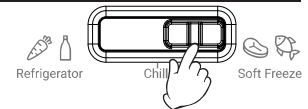

Adjusting the shelves.

- Pull up the back and pull out the shelf forward.
- Set the refrigerator shelves by combining with stored food.



CAUTION

- Shelf trims are removable, Holding the shelf with both hands. DO NOT holding trim or holding shelf with only one hand otherwise it may drop or injury.

6

Other Function

1

■ Door Alarm

If the door is left open for more than 1 minute, the alarm system will inform the user by the light and sound.

- Door Alarm : Informs by PeepPeepPeep sound.
- Alarm lighting : Informs by flashing light.
- Alarm display : Informs by flashing light on the control panel.

Duration of Door Opening	Door Alarm Sound	Flashing Light	Control panel
*** After 30 seconds	Peep (5 Times)	4 Times	All LED on control panel are flashing
After 1 minute	Peep (5 Times)	4 Times	
After 2 minutes	Peep (10 Times)	9 Times	
After 3 minutes	Peeps continuously	Continuously	

*** If Eco Mode is enabled, the alarm system will inform the user when the door is left open more than 30 seconds.

To Disactivate Alarm and Sound

1. Keep pressing "Refrigerator and Eco Mode" button for 5 seconds until "Peep!" sound is heard.
2. There is not sound when pressing any button (deactive door alarm sound)

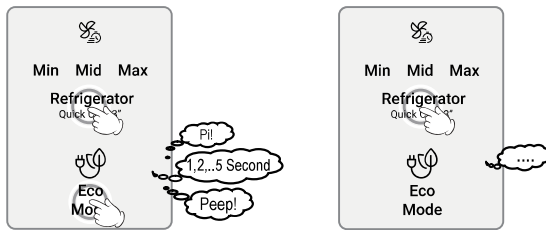

To re-activate Alarm and Sound

1. Keep pressing "Refrigerator and Eco Mode" button for 5 seconds until "PiPi!" sound is heard.
2. There is sound when pressing any button (active door alarm sound).

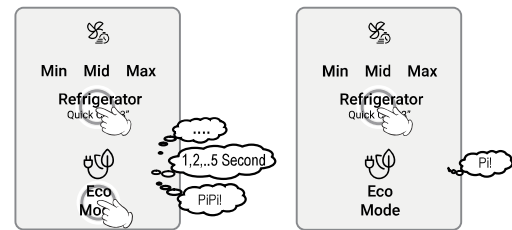

NOTICE

- Factory setting, the alarm and sound are set "ON"
- If the Door Alarm, Eco Alarm Display and each button operation sound have been deactivated, The refrigerator will still set the alarm and sound to "OFF" even though a power failure or when unplugging and reconnecting the power plug.
- There must set more than 45 seconds before unplug the power or power failure. otherwise the temperature display shown as before setting.

Care and Maintenance

1

Cleaning (To Clean the refrigerator once a month)

1. Unplug the refrigerator.
2. Take out all the food.
3. Wipe the refrigerator clean.
 - It is highly recommended to wiping off smudges immediately. It is also recommended to clean the areas of the refrigerator which are not easily accessible, once a year
 - Use soft cloth with lukewarm water to wipe off smudges. If it is difficult to remove smudges, use diluted, ph-balanced washing liquid.
 - Neatly clean the door gasket, because it gets dirty easily.
4. If any droplets remain on the surface of the parts, wipe them off.
5. Return all parts to their original locations.
6. Check and clean the power plug, cord and outlet.
7. Plug the power cord into the outlet.

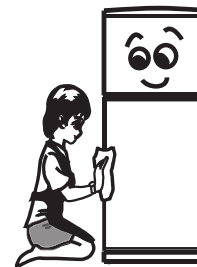

NOTICE

- Even if the power plug is plugged in immediately after being unplugged, the compressor will not run for 10 minutes. However, if the inside is not cold, it will start running in approximately 30 seconds.

CAUTION

Do not do the following, since parts and paint may be damaged.

1. Do not splash water to the doors and refrigerator body.
 - It may cause electric shock or a fire.
 - It may cause refrigerant leakage because of pipe rust.



2. Do not use following: Polishing powder, soap powder, oil boiling water, brush, acid, benzene, thinner, alcohol and alkaline detergent, etc.
 - It may damage door surface.
 - It may crack plastic parts.
3. If the cooking oil smears on the refrigerator, please wipe it off immediately. Otherwise, the plastic parts might be cracked.

Replace spare parts.

Drain pan.

1. Take 2 screws out.
2. Take the middle hook out.

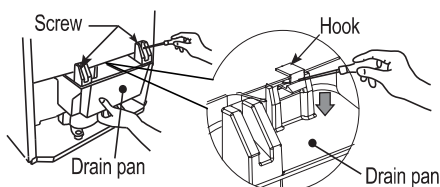

Troubleshooting





Before you call for service, please check the following items:

Problem	Things to check	Instructions	Page
The refrigerator does not get cold at all.	<ul style="list-style-type: none"> Is the refrigerator plugged in properly? 	<ul style="list-style-type: none"> Check the fuse box for blown fuse or tripped circuit breaker. 	2
The refrigerator does not get cold enough.	<ul style="list-style-type: none"> Is the refrigerator placed in the direct sunlight? Is the temperature set to "Cold"? Is the food stored too much? Is the door slightly opened? Is the refrigerator placed near heat sources? Has anything hot been placed in the refrigerator? Is the door opened and closed too frequently? 	<ul style="list-style-type: none"> Do not install the refrigerator in a place where it may come in contact with sunlight. Set panel of Temperature control to "Normal" or "Coldest". Keep enough space between food. Should close the door firmly closed. Do not install the refrigerator in a place where it may come in contact with heat sources. Make food cool enough before putting in the refrigerator Do not open & close the door too frequently. 	4 5 4 - 4 4 -
Food in the refrigerator compartment freezes.	<ul style="list-style-type: none"> Is the temperature set to "Coldest"? Do you place food with moisture or vegetables nearby the cold air vent? It will be frozen if it is placed nearby the cold air vent. 	<ul style="list-style-type: none"> Set panel of Temperature control to "Normal or Cold". Keep enough space between food, Do not block the cold air vent. 	5 4
The inside is smelling.	<ul style="list-style-type: none"> Do you store food with odor without warpping it? 	<ul style="list-style-type: none"> Using food wrap or sealed containers. 	4
The refrigerator is noisy	<ul style="list-style-type: none"> Make sure the refrigerator is installed frimly. Is the refrigerator touching the wall? 	<ul style="list-style-type: none"> Should be install the refrigerator by following the preparing instruction manual. 	4

This is not a malfunction of the refrigerator:

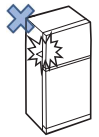
Problem	Things to check	Instructions	Page
The surface of the refrigerator is hot.	-	<ul style="list-style-type: none"> The refrigerator is equipped with the dew prevention and heat radiation tubes. The back and side plates may be heated especially when starting up or if the door is frequently opened and closed. 	-
If a door is shut, other doors may open.	-	<ul style="list-style-type: none"> The two compartments are connected with an air duct. When closing one of the doors, the other door may be opened by the air pressure through the duct. This is a normal phenomenon. 	-
Does the refrigerator make any abnormal noises (sound)?	-	<ul style="list-style-type: none"> The sound like water flowing and boiling water is the sound of the cooling liquid (refrigerant). A creaking sound comes from the storage compartment. It is the sound caused by friction of the parts due to temperature change. 	-
There are waving and / or distortions on the door surface, the side and the top surface of the refrigerator.	-	<ul style="list-style-type: none"> Slight waving and/or distortions are generated in the manufacturing process of the refrigerator. They may be conspicuous according to the position of the light source and/or the brightness etc., but there is no problem with the performance. 	-

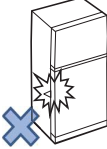
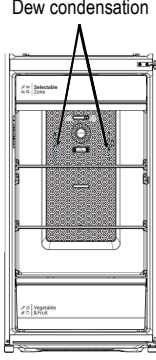
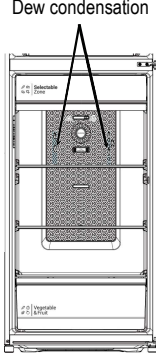
Dew or Frost is generated

General operation	Please check here	Possible causes and / or Recommended solutions
Frost or ice is generated in the freezer compartment	The door of the freezer compartment was not left open temporarily?	Check that the wrapping paper of the food is not getting caught in order not to make gap between door and door gasket when you close the door. 
	The door of the freezer compartment was not opened frequently or longer time than necessary?	When the door is opened frequently or if the door is opened when the humidity around the refrigerator is high, moisture in the air may be turned into some frost or ice on the inner wall or component of the freezer compartment, or around the air channels. This is not a failure. Please try not to open the door too many times or for a long time. Also, please wipe frost or ice generated in the freezer compartment off with use of a dry cloth. 
	Making extra ice by using an additional ice-tray which was not originally installed in the refrigerator?	When the many containers in which water or liquid is stored are put in the same time, water or liquid may be evaporated and turned into frost or ice on the wall or component of the freezer compartment, or around the air channels. You can suppress these frost and ice by putting lid to avoid evaporation. Please wipe frost and ice off with use of a dry cloth. 
Dew is generated in the refrigerator compartment	The door of the refrigerator compartment was not left open temporarily?	Please check not to pinch the food or plastic bag between the door and door frame when you close the door. 
	The door of the refrigerator compartment was not opened frequently or longer time than necessary?	When the door is opened frequently or if the door is opened when the humidity around the refrigerator is high, moisture in the air may be turned into some dew on the inner wall or component of the refrigerator compartment, or around the chilled air blow-off port. This is not failure. Please try not to open the door too many times or for long time. Also, please wipe off the dew in the refrigerator compartment with dry cloth. 
	Storing many vegetables containing much water?	The humidity of the vegetable compartment is higher than other compartments. Accordingly, depending on the amount or type of the vegetable, dew condensation may be generated on the plastic case of vegetable compartment. However, this is not a failure. When you do not want to have this kind of dew, please wrap your vegetables in a plastic film. Also, when the dew condensation happens many times, water may be accumulated in the vegetable compartment. Please wipe the water off with a dry cloth. 
Dew is generated on outer surface of the refrigerator	The volume of humidity around the refrigerator is not high?	When the humidity rises such as in rainy day, some dew may be generated on the outer surface of the refrigerator. Please wipe the dew off with a dry cloth. 
	The temperature setting is not set as "Coldest"?	When the temperature setting is set as "Coldest", some dew may be generated on the outer surface of the refrigerator. Please set the setting as "Normal". Also, please wipe dew off with use of a dry cloth. 

Why frost and dew are generated?

When warm and humid air contacts something cold, dew is generated. For example, if you put some ice in the glass in your room, air around the glass will be cold down and some dew may be generated on the outer surface of the glass.

In the same way, when warm and humid air enters into the refrigerator at the door opening, the warm and humid air contacts cold inner wall and little dew may be generated.

Accordingly, if the door opening is too frequent or too long, dew will be accumulated at every door opening. In some cases, dew may be frozen to generate some frost or ice flakes in the freezer compartment.



Service Center

- Before you request repair, please check the refrigerator well according to page number 8. If it is still abnormal, please contact the retailer of purchase or the following service center.

Customer Service Center

Beko A&NZ Pty Ltd
55 Blanck Street, Ormeau QLD 4208
Email: custserv@hitachi.com.au
Phone: 1300 470 552
Web: <https://www.hitachi-homeappliances.com/au-en/>
Monday to Friday business hours 9am – 5 pm (AEST)

- Telephone number is subject to change without notice.

About Non-fluorocarbon refrigerator

- This refrigerator, including refrigerant and the heat insulator, is using hydrocarbon (non-fluorocarbon).
- R600a refrigerant is flammable. But the refrigerant is sealed up by the refrigerant circuit, and never leaks by usual use. In case of the refrigerant circuit being damaged by any chance, please avoid using fire or electric product, open the window and ventilate. Afterwards, please contact Hitachi Service Center.

Sever warning signs for Disposal

Cyclopentane is used as in the insulation. The gases in insulation material require a special disposal procedure.
Please contact your local authorities in regard to the environmentally safe disposal of this product.



This symbol mark means that used electrical and electronic products shall not be mixed with general household waste.
Do not try to dismantle the system and unit by yourself as this could have harmful effects on your health and the environment.
Refrigerators must be treated at a specialized treatment facility for recycling and recovery and shall not be disposed of in the municipal waste stream. Please contact the installer, dealer or local authority for more information.

- Manufactured by Arcelik Hitachi Home Appliances (Thailand) Ltd
610/1 Moo 9 Tambol Nongki, Amphur Kabinburi, Prachinburi 25110 Thailand.



430-HRPK2667A_INST-B-W66-24-H10-AUS