



DRAPER[®]

RECHARGEABLE

SPOTLIGHT

66028/66029



CE

These instructions accompanying the product are the original instructions. This document is part of the product, keep it for the life of the product passing it on to any subsequent holder of the product. Read all these instructions before assembling, operating or maintaining this product.

This manual has been compiled by Draper Tools describing the purpose for which the product has been designed, and contains all the necessary information to ensure its correct and safe use. By following all the general safety instructions contained in this manual, it will ensure both product and operator safety, together with longer life of the product itself.

All photographs and drawings in this manual are supplied by Draper Tools to help illustrate the operation of the product.

Whilst every effort has been made to ensure the accuracy of information contained in this manual, the Draper Tools policy of continuous improvement determines the right to make modifications without prior warning.

1. TITLE PAGE

1.1 INTRODUCTION

User manual for Rechargeable Spotlight

Stock No: 66028/66029

Part No's: RLED20/RLED30

1.2 REVISIONS

Date first published March 2017

As our user manuals are continually updated, users should make sure that they use the very latest version.

Downloads are available from: <http://www.drapertools.com/manuals>

Draper Tools Limited, Hursley Road, Chandler's Ford, Eastleigh, Hampshire.
SO53 1YF. UK.

Website: drapertools.com

Product Helpline: +44 (0) 23 8049 4344

General Fax: +44 (0) 23 8026 0784

1.3 UNDERSTANDING THIS MANUALS SAFETY CONTENT:

Warning! – Information that draws attention to the risk of injury or death.

Caution! – Information that draws attention to the risk of damage to the product or surroundings.

1.4 COPYRIGHT © NOTICE:

Copyright © Draper Tools Limited.

Permission is granted to reproduce this publication for personal and educational use only. Commercial copying, redistribution, hiring or lending is prohibited.

No part of this publication may be stored in a retrieval system or transmitted in any other form or means without written permission from Draper Tools Limited.

In all cases this copyright notice must remain intact.

1. TITLE PAGE	
1.1 INTRODUCTION.....	1
1.2 REVISION HISTORY	2
1.3 UNDERSTANDING THIS MANUAL	2
1.4 COPYRIGHT NOTICE	2
2. CONTENTS	
2.1 CONTENTS.....	3
3. GUARANTEE	
3.1 GUARANTEE.....	5
4. INTRODUCTION	
4.1 SCOPE.....	6
4.2 SPECIFICATION.....	6
4.3 HANDLING AND STORAGE	6
5. HEALTH AND SAFETY INFORMATION	
5.1 GENERAL SAFETY INSTRUCTIONS FOR POWER TOOL USE	7
– Electrical safety	7
– Personal safety.....	7
– Battery tool use and care.....	7
– Service.....	8
5.2 ADDITIONAL SAFETY INFORMATION	8
5.3 CONNECTION TO THE POWER SUPPLY (CHARGER).....	8
6. IDENTIFICATION	
6.1 TECHNICAL IDENTIFICATION	9
7. UNPACKING AND CHECKING	
7.1 PACKAGING	10
7.2 WHAT'S IN THE BOX.....	10
8. OPERATION AND USE	
8.1 POWER SUPPLY	11
8.2 CHARGING AC OR DC	11
8.3 SPOTLIGHT OPERATION	12
8.4 ADJUSTABLE STAND	13
9. MAINTENANCE	
9.1 MAINTENANCE.....	14

2. CONTENTS

10. EXPLANATION OF SYMBOLS	
10.1 EXPLANATION OF SYMBOLS	15
11. DISPOSAL	
11.1 DISPOSAL	16
11.2 HEALTH AND SAFETY FOR BATTERIES	16
DECLARATION OF CONFORMITY	
.....	ENCLOSED

3.1 GUARANTEE

Draper tools have been carefully tested and inspected before shipment and are guaranteed to be free from defective materials and workmanship.

Should the tool develop a fault, please return the complete tool to your nearest distributor or contact:

Draper Tools Limited, Chandler's Ford, Eastleigh, Hampshire, SO53 1YF. England.

Telephone Sales Desk: (023) 8049 4333 or: Product Helpline (023) 8049 4344.

A proof of purchase must be provided with the tool.

If upon inspection it is found that the fault occurring is due to defective materials or workmanship, repairs will be carried out free of charge. This guarantee period covering parts/labour is 12 months from the date of purchase except where tools are hired out when the guarantee period is 90 days from the date of purchase. The guarantee is extended to 24 months for parts only. This guarantee does not apply to normal wear and tear, nor does it cover any damage caused by misuse, careless or unsafe handling, alterations, accidents, or repairs attempted or made by any personnel other than the authorised Draper warranty repair agent.

Note: If the tool is found not to be within the terms of warranty, repairs and carriage charges will be quoted and made accordingly.

This guarantee applies in lieu of any other guarantee expressed or implied and variations of its terms are not authorised.

Your Draper guarantee is not effective unless you can produce upon request a dated receipt or invoice to verify your proof of purchase within the guarantee period.

Please note that this guarantee is an additional benefit and does not affect your statutory rights.

Draper Tools Limited.

4. INTRODUCTION

4.1 SCOPE

Plastic bodied 20W or 30W CREE LED spotlight. Suitable for use in industrial, domestic and leisure environments. Supplied with a Li-Ion rechargeable battery, 230V AC mains charger and 12 volt DC accessory charger.

4.2 SPECIFICATION

Stock No	66028	66029
Part No	RLED20	RLED30
LED.....	20W CREE XHP50 LED	30W CREE XHP70 LED
Lumens:		
High	1600	2000
Low.....	600	800
Beam distance (Max.).....	500M	600M
Battery:		
Type	Lithium-Ion	Lithium-Ion
Rated voltage.....	7.4V.....	7.4V
Rating	2.4Ah	4.4Ah
Charging time.....	8hrs	14hrs
Continuous spotlight operating time (on one full charge):		
High	1.5hrs	2hrs
Low.....	4.5hrs	6hrs
Charger:		
Rated voltage.....	230V~	230V~
Rated frequency	50Hz	50Hz
Rated power input	6.3W.....	6.3W
Rated D.C. output voltage.....	9V.....	9V
Rated D.C. output current	500mA	500mA
Construction:	Class II	Class II
Dimensions:	269 × 222 × 222mm	269 × 222 × 222mm
Weight (spotlight only):	1.35kg	1.5kg

4.3 HANDLING AND STORAGE

Store in a dry location out of the reach of children.

5.1 GENERAL SAFETY INSTRUCTIONS FOR POWER TOOL USE

Warning: Read all safety warnings and all instructions. Failure to follow the warnings and instructions may result in electric shock, fire and/or serious injury.

Save all warnings and instructions for future reference.

The term “power tool” in the warnings refers to your mains operated (corded) power tool or battery-operated (cordless) power tool.

Electrical safety

- a) Power tool plugs must match the outlet. Never modify the plug in any way. Do not use any adapter plugs with earthed (grounded) power tools. Unmodified plugs and matching outlets will reduce risk of electric shock.
- b) Avoid body contact with earthed or grounded surfaces such as pipes, radiators, ranges and refrigerators. There is an increased risk of electric shock if your body is earthed or grounded.
- c) Do not expose power tools to rain or wet conditions. Water entering a power tool will increase the risk of electric shock.
- d) Do not abuse the cord. Never use the cord for carrying, pulling or unplugging the power tool. Keep cord away from heat, oil, sharp edges or moving parts. Damaged or entangled cords increase the risk of electric shock.
- e) When operating a power tool outdoors, use an extension cord suitable for outdoor use. Use of a cord suitable for outdoor use reduces the risk of electric shock.
- f) If operating a power tool in a damp location is unavoidable, use a residual current device (RCD) protected supply. Use of an RCD reduces the risk of electric shock.

Personal safety

- a) Stay alert, watch what you are doing and use common sense when operating a power tool. Do not use a power tool while you are tired or under the influence of drugs, alcohol or medication. A moment of inattention while operating power tools may result in serious personal injury.
- b) Use personal protective equipment. Always wear eye protection. Protective equipment such as dust mask, non-skid safety shoes, hard hat, or hearing protection used for appropriate conditions will reduce personal injuries.
- c) Prevent unintentional starting. Ensure the switch is in the off position before connecting to power source and/or battery pack, picking up or carrying the tool. Carrying power tools with your finger on the switch or energising power tools that have the switch on invites accidents.
- d) Remove any adjusting key or wrench before turning the power tool on. A wrench or a key left attached to a rotating part of the power tool may result in personal injury.

Battery tool use and care

- a) Recharge only with the charger specified by the manufacturer. A charger that is suitable for one type of battery pack may create a risk of fire when used with another battery pack.
- b) Use power tools only with specifically designated battery packs. Use of any other battery packs may create a risk of injury and fire.

5. HEALTH AND SAFETY INFORMATION

- c) When battery pack is not in use, keep it away from other metal objects, like paper clips, coins, keys, nails, screws or other small metal objects, that can make a connection from one terminal to another. Shorting the battery terminals together may cause burns or a fire.
- d) Under abusive conditions, liquid may be ejected from the battery; avoid contact. If contact accidentally occurs, flush with water. If liquid contacts eyes, additionally seek medical help. Liquid ejected from the battery may cause irritation or burns.

Service

- a) Have your power tool serviced by a qualified repair person using only identical replacement parts. This will ensure that the safety of the power tool is maintained.

5.2 ADDITIONAL SAFETY INFORMATION

- Do not point (shine) the light into any persons or animals eyes.
- Do not use near children.
- Store out of the reach of children.
- Do not put this unit into a fire or use near any flammable object.
- Do not use in explosive atmospheres or environments.
- Do not use excessive force on this product as it can permanently damage the spotlight.
- Only use the charger in a standard environment.
- Do not use the charger to charge any other product and only use the supplied charger to charge this spotlight.

5.3 CONNECTION TO THE POWER SUPPLY (CHARGER)

This spotlight comes supplied with a UK standard 3 pin charger. It is designed for connection to a domestic power supply rated at 230V AC.

It is Class 2 (double insulated); is designed for connection to a power supply matching that detailed on the rating label and compatible with the plug fitted.

If an extension lead is required, use an approved and compatible lead rated for this appliance. Follow all the instructions supplied with the extension lead.

This product requires no earth connection as supplementary insulation is applied to the basic insulation to protect against electric shock in the event of failure of the basic insulation.

6.1 TECHNICAL IDENTIFICATION



- ① Handle.
- ② ON/OFF/ beam settings switch.
- ③ Lens.
- ④ Power input charging point.
- ⑤ Adjustable stand.

7. UNPACKING AND CHECKING

7.1 PACKAGING

Carefully remove the spotlight from the packaging and examine it for any sign of damage that may have happened during shipping. Lay the contents out and check them against the parts shown below. If any part is damaged or missing; please contact the Draper Helpline (the telephone number appears on the Title page) and do not attempt to use the spotlight.

The packaging material should be retained at least during the guarantee period: in case the spotlight needs to be returned for repair.

Warning! Some of the packaging materials used may be harmful to children. Do not leave any of these materials in the reach of children.

If any of the packaging is to be thrown away, make sure they are disposed of correctly; according to local regulations.

7.2 WHAT'S IN THE BOX?

As well as the spotlight; there are several parts not fitted or attached to it.

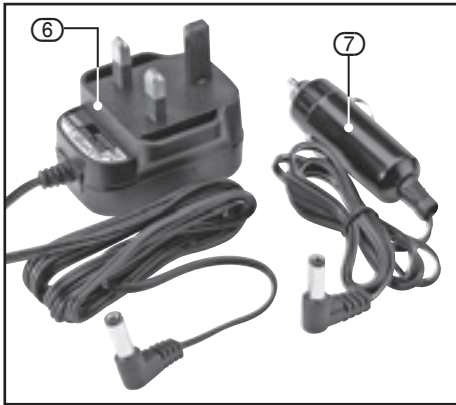

⑥ 230V AC mains charging adaptor.

⑦ 12V DC in-car adaptor charger.

8.1 POWER SUPPLY – FIG. 1

Before you connect the equipment to the power supply make sure that the data on the rating plate is identical to the supply voltage.

Warning! Always pull out the power plug before making adjustments to the equipment.

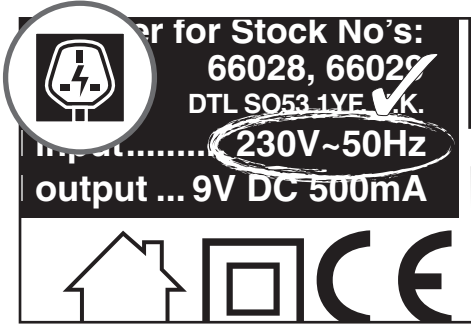



FIG.1

8.2 CHARGING AC OR DC – FIG. 2

Note: Before using the spotlight, charge the battery for the following:

 RLED20	RLED30
8 hours	14 hours

The table below highlights the approximate hours of continuous useage available for each spotlight when fully charged:

 RLED20	RLED30
High: 1.5 hours	High: 2 hours
Low: 4.5 hours	Low: 6 hours

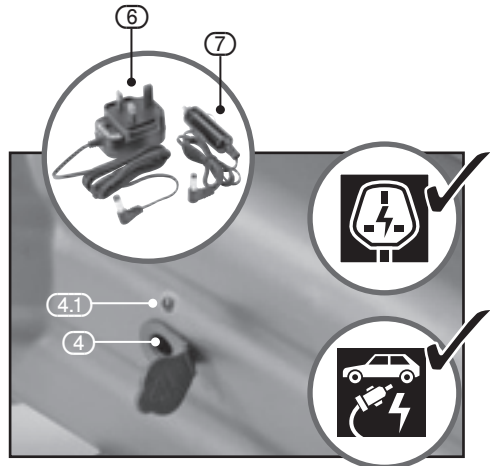

FIG.2

As the charge diminishes, the light intensity will begin to reduce. The battery should be recharged before it is drained completely.

- Before charging, ensure the ON/OFF button (2) is in the off position.
- Depending on requirements, insert the 230V AC mains charging adaptor (6), or the 12V DC in-car adaptor charger (7) into the charging input point (4).
- The LED indicator (4.1) will illuminate whilst charging and then extinguish when the battery is fully charged.

Note: if stored for emergencies, ensure it is fully charged and recharge every four months regardless of use.

8. OPERATION AND USE

- Lithium-ion cells prefer small charges often.
- Lithium-ion technology is lightweight and compact due to increased capacity in comparison to other battery chemistries.
- Lithium-ion cells have no 'memory effect' and a long cycle life with outstanding discharge performance.
- Lithium-ion cells suffer from a loss in capacity or thermal runaway if over charged and will degrade if allowed to enter deep discharge, however all of these situations are negated due to the complex circuitry incorporated within this product.
- Charging must be carried out in an environment with an ambient air temperature between 5 to 45 with the transformer supplied.
- To prevent overheating, do not cover the transformer.

Warning! If the cable is damaged or the non-self resetting protective device is activated due to short circuit/overload, the transformer shall be scrapped. A replacement of identical specification, design and application shall be obtained.

Note: Charging the unit with the 12V DC charger via a vehicle socket will drain the vehicle's battery unless the engine is running.



8.3 SPOTLIGHT OPERATION – FIG. 3

The spotlight is operated via the ON/OFF/ beam setting switch (2).

① Slide the switch forward for the lower powered beam(A).

② Slide forward further full powered beam(B).

- Slide the switch back to the original position to switch off.

Warning! The spotlight produces a high intensity light. Do not point the spotlight at the eyes or aim at objects that are very close.

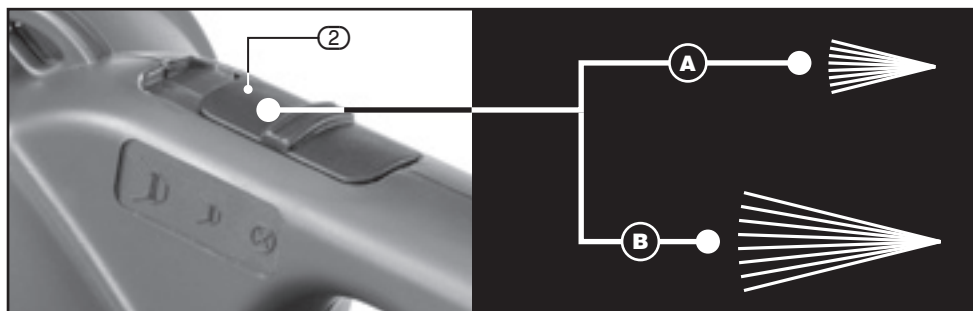

FIG.3

8.4 ADJUSTABLE STAND – FIG. 4

When 'hands-free', stand alone operation is required, the spotlight features 2 pivoting supports (5) that allow the light source to be adjusted within incremental angles.



FIG.4

9. MAINTENANCE

9.1 MAINTENANCE – FIG. 5

Use only mild soap and a damp cloth to clean this spotlight. Do not submerge into liquid.

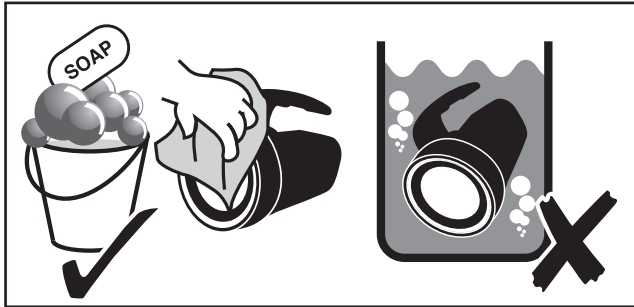

FIG.5

10. EXPLANATION OF SYMBOLS



Class II construction (Double insulated).



12V DC in-car charger adaptor



WEEE
Do not dispose of Waste Electrical & Electronic Equipment in with domestic rubbish.



spotlight battery charging time (usually denoted with time indicator).



Li-ion

Lithium-ion product.
Refer to your local authority for advice on disposal and recycling.



Maximum spotlight operating (burn) time (usually denoted with time indicator).



For indoor use only.
Do not expose to rain.



Short-circuit-proof safety isolating transformer.



Polarity indication.



Rated voltage.



Do not incinerate or throw onto fire.



Warning! Read the instruction manual.



Warning! Do not aim beam at bystanders or look directly into light source.



230V charger adaptor

11. DISPOSAL

11.1 DISPOSAL

At the end of the machine's working life, or when it can no longer be repaired, ensure that it is disposed of according to national regulations.

Contact your local authority for details of collection schemes in your area.

In all circumstances:

- Do not dispose of power tools with domestic waste.
- Do not incinerate.
- Do not abandon in the environment.
- Do not dispose of WEEE* as unsorted municipal waste.



11.2 HEALTH AND SAFETY FOR BATTERIES

Warning! Do not put in fire or mutilate – cells may burst or release toxic materials.

- Do not short circuit cells, may cause burns.
- The battery must be removed from the appliance before it is scrapped.
- The battery is to be disposed of safely.
- Do not mutilate batteries, corrosive electrolyte will be released.
- Do not incinerate – danger of explosion and release of toxic fumes.
- Do not dispose of batteries or cells in a charged condition.

Expired lithium-ion batteries must be recycled/disposed of in accordance with the appropriate regulation or legislation. They should be returned to your local warranty agent/stockist.

* Waste Electrical & Electronic Equipment.

NOTES

CONTACT US

Draper Tools Limited, Hursley Road,
Chandler's Ford, Eastleigh, Hampshire. SO53 1YF. U.K.

Helpline: (023) 8049 4344

Sales Desk: (023) 8049 4333

Internet: www.drapertools.com

E-mail: sales@drapertools.com

General Enquiries: (023) 8026 6355

Service/Warranty Repair Agent:

For aftersales servicing or warranty repairs, please contact the Draper Tools Helpline for details of an agent in your local area.

YOUR DRAPER STOCKIST

RDCH0417

©Published by Draper Tools Limited.

No part of this publication may be reproduced, stored in a retrieval system or transmitted in any form or by any means, electronic, mechanical photocopying, recording or otherwise without prior permission in writing from Draper Tools Ltd.