



User Manual

Smart Pet Feeder with Camera (2.4G/5G WiFi)

Model:ACF100W



If the product is upgraded in the following please refer to the actual product in hand.

Safety Instructions



Please do not use wet, canned or moist food.



This product uses 3 × D Cell Batteries as a backup power supply. Please use double power supply to ensure the normal use of the product.



Examine the feeder after installation. Do not plug in if there is water on the power cable or plug.



Do not immerse the base part in water at any time as it may damage electronic components.



Do not disassemble the feeder other than as instructed in this user manual.



Only use accessories recommended or sold by the manufacturer. The use of accessories not recommended or sold by the manufacturer may cause an unsafe condition.



Dispose of all packaging materials properly. Some items may be packed in plastic bags, these bags could cause suffocation.

Warranty

Any questions about the use of the product, you can contact our brand after-sales staff. We will solve your problem until it is resolved.

◆ **1-Year Warranty**

◆ **24/7 Online Support**

For guidance on product use and warranty extension, please contact our brand after-sales staff via email: **support@frienhund.com**
If any questions related to orders, please contact the seller through the shopping platform.

◆ **Monday-Friday:**

Tel: 1-877-631-3655 (PST 8:00 am-5:00pm)

◆ **Scan the code to view Installation Video, Wi-Fi Connection Tutorials, App Feature Descriptions.**



Product Specifications

Product Name	Smart Pet Feeder with Camera (2.4G/5G WiFi)
Suit For	Cat, Dog, Rabbit, Small Pets, Multiple Pets
Rated Voltage	5V 1A
Product Power	5W
Power Supply	Power Adapter and 3× D Cell Batteries
Material	ECO-Friendly ABS
Product Size	180*315*390mm/7*12.4*15.3in
Product Weight	1.67kg/3.68lb
Product Capacity	7L
Pet Food	Dry Food
Portion Size	5~12g(0.01~0.02lb)
Camera	2K Night Vision Camera

Packing List

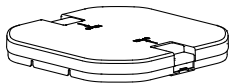

Lid*1



Power Adapter*1



Desiccant*1

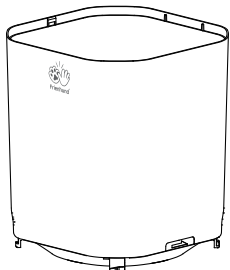

Food Tank*1



USB Cable*1



Desiccant Compartment*1



ABS Wall Hook*1



Anchors*4



Screws*4

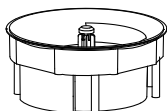

Meal Splitter*1



Stainless Steel Feeding Bowl*1



Bowl Tray*1

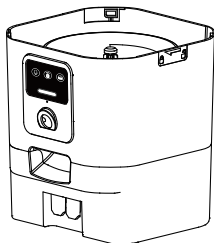

Feeder Base*1



User Manual*1

Product Overview

1	Lid
2	Desiccant
3	Desiccant Compartment
4	Food Tank
5	Meal Splitter
6	Control Panel
7	Camera
8	Food Outlet
9	Stainless Steel Feeding Bowl
10	Bowl Tray

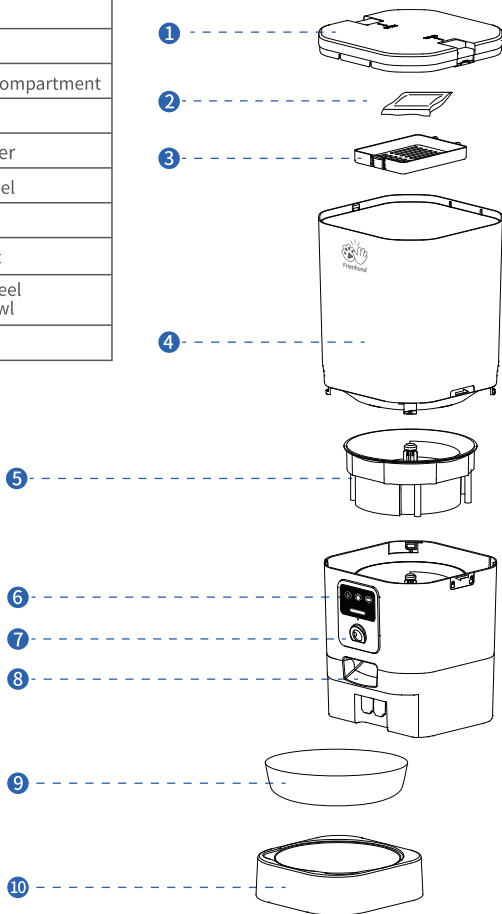

Assembled Products

Step 1 Connecting Power

1

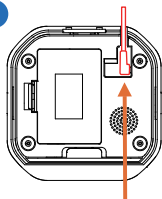

Power Cable

- Plug the 5V power adapter into the bottom of the feeder.

2

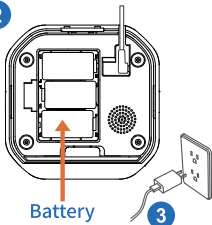

Battery

- Install 3 × D Cell Batteries in the bottom of the feeder in case of power outages in the home.
- Plug in the home power supply.

4

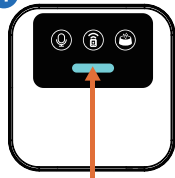

Indicator

- When the indicator is blinking blue, it means waiting for network connection.

Step 2 Meal Splitter Installation

5

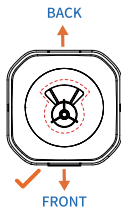
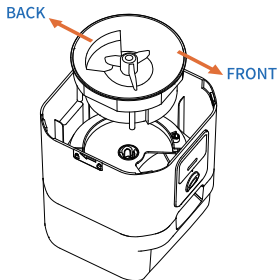

- The entrance of pet food faces towards the back of the product.

Step 3 Food Tank Installation

6

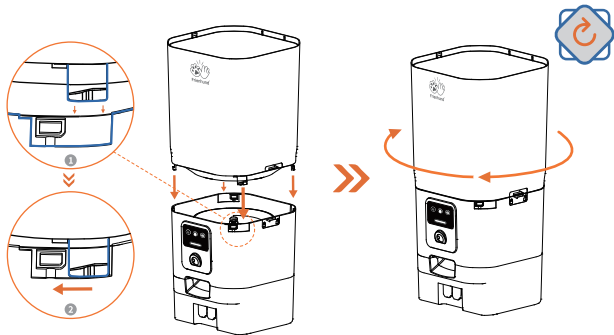

- Install as shown.
- The opening in the bottom of the food tank should match the opening in the base of the feeder, then turn clockwise to lock.

Step 4 Feeder Base Installation

7

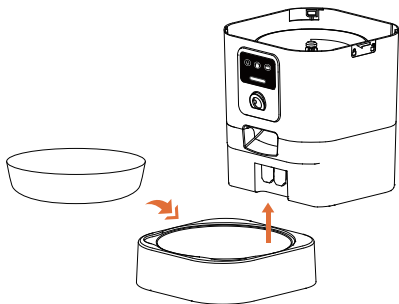

- Place the stainless steel bowl into the bowl tray.
- Insert the bowl tray into the feeder base.

Step 5 Add Food

8

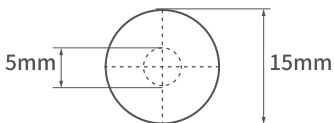
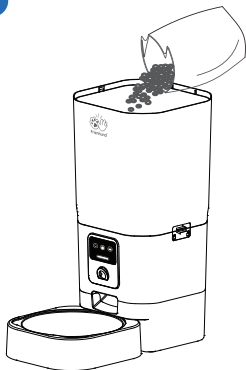

⚠ Note:

1. Please pour in dry food, not wet food or canned food.
2. Recommended food size: 5-15mm (0.19-0.59in)

9

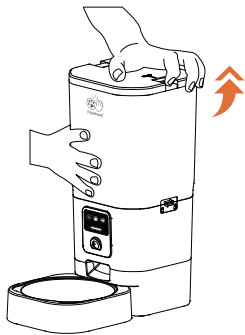
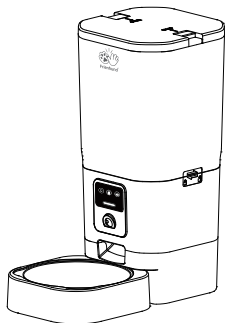

- Close the lid

Tips:

Please refer to the picture to open the feeder lid.

Step 6 Wall Hook Installation

1

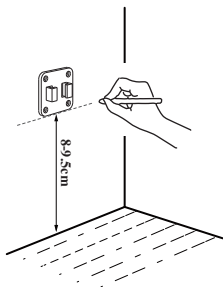

- Place the wall hook on the wall and mark the holes using a pen.
Note: The wall hook must be kept 8-9.5cm (3.15-3.75in) away from the floor.

2

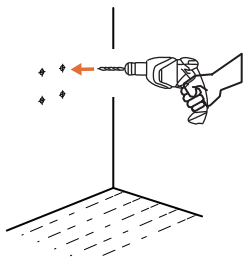

- Use an impact drill to drill the holes
Note: Use a 1/4" (6mm) diameter drill bit.

3

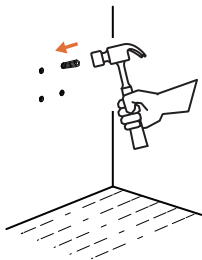

- Use a hammer to tap the plastic wall anchors plug into the hole, flush with the wall.

4

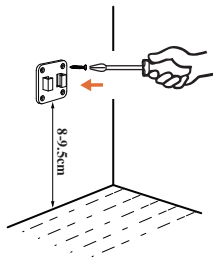

- Tighten screws to secure wall hook.

5

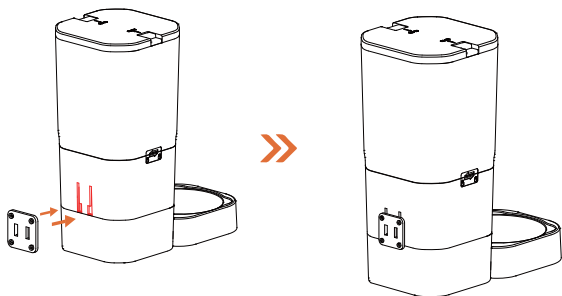

6

- Align the holes on the back of the feeder with the hooks on the wall hook and slide down.
- Installation completed.

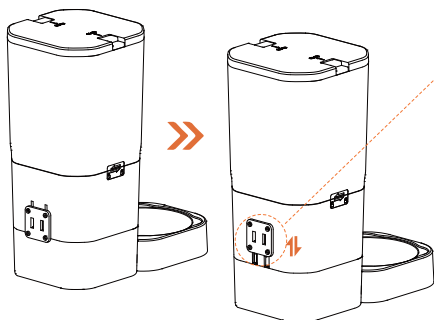
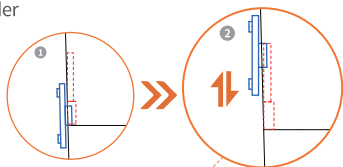

Memory Card Installation

1

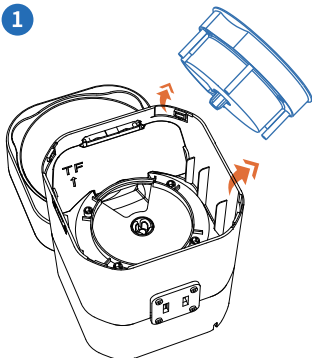

- Take out the meal splitter from the feeder base.

2

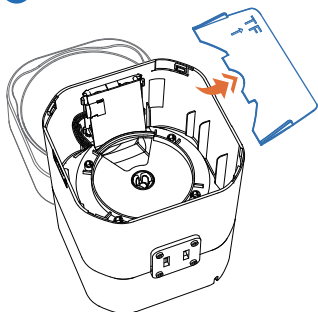

- Take out the baffle.

3

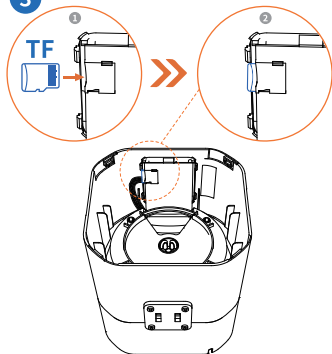

- Insert a TF card into the slot of PCB.
Note: Only TF cards formatted in FAT32 are supported (up to 128GB).

4

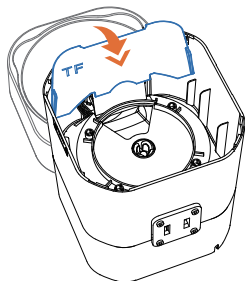

- Attach the baffle.

Buttons Explained

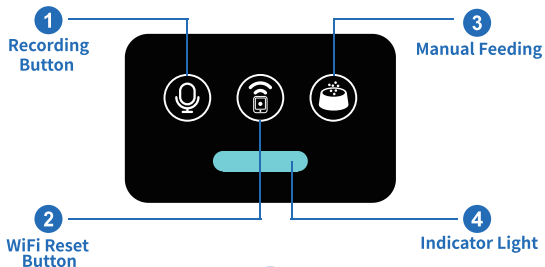

Recording Button

1. Record Sound

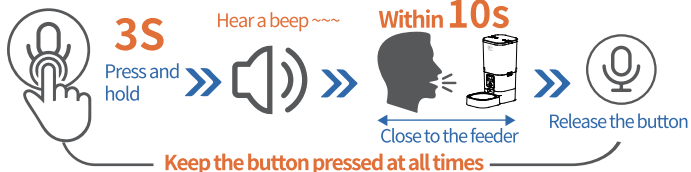

2. Check the Recordings



Press to play the recorded sound

3. Clearing Recordings

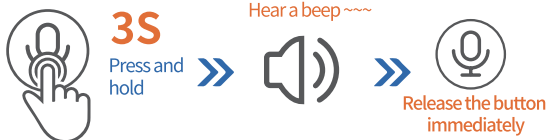







WiFi Reset

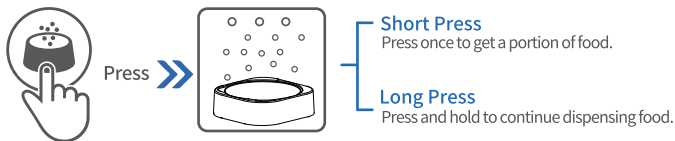

Manual Feeding



Indicator Light Description

Color of Light	Status
 Blue Light Flashing	Waiting for WiFi Connection
 Blue Light Always On	WiFi Connected
 Red Light Always On	Enough Battery (Battery Powered Only)
 Red Light Flashing	Low Battery (Battery Powered Only)

▲ Note:

After the blue light starts flashing, please finish connecting your phone to the device within fifteen minutes, otherwise the blue light will go out. At this point, if you want to restart the blue light blinking state, you need to either re-plug the power supply or press and hold the Wi-Fi reset button for 5 seconds to reset it.

Install the APP and Log In

App Installation

Scan the QR code or search in your device's app store to download and install the Smart Life app.



Smart Life



Sign up and log in

After opening the app, if you don't have an account, please register one. If you have already, please log in directly.

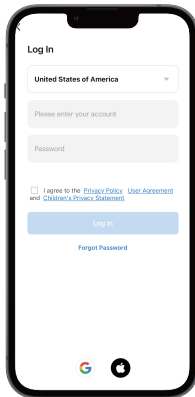

Add Feeder to APP

Step 1: Turn on phone permissions.



▲ Note:

1. Before adding the device to the APP, please make sure the indicator light on the feeder is blinking blue, as well as the **Bluetooth**, **WLAN**, and **GPS** in your phone are on.
2. **Network connection is only possible when plugged in.**

Step 2: The feeder is ready to connect to the network

- ◆ Turn on the power to the feeder.
- ◆ **Make sure the indicator light on the feeder is flashing blue.**

- 1 Please open the Smart Life APP → Tap the [+] in the upper right corner to add the device.

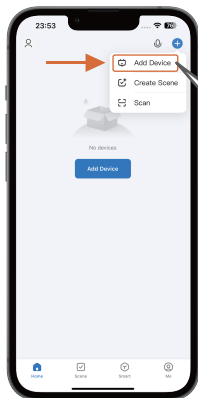

+

Add Device

- 2 Please follow the app prompts to operate.

Method 1 Bluetooth Connection

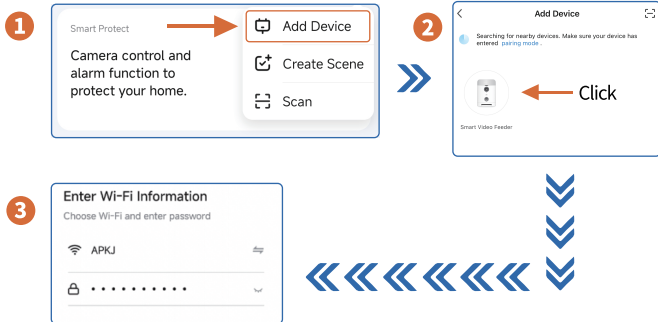

Method 2 Camera Scanning QR Code Connection

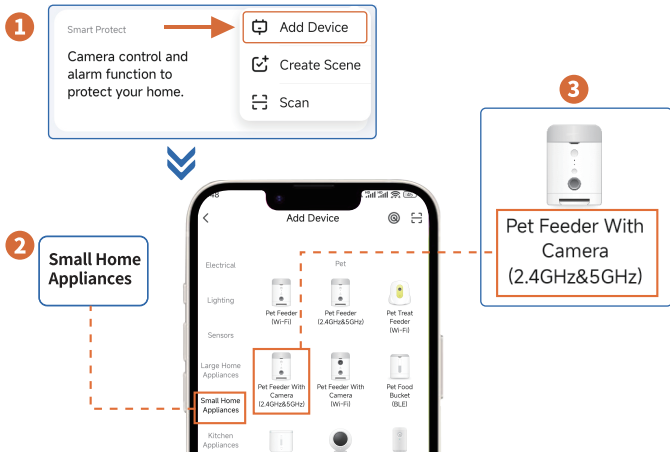

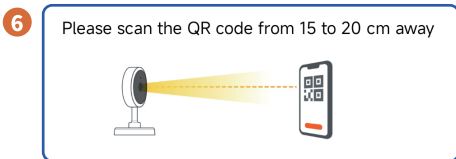
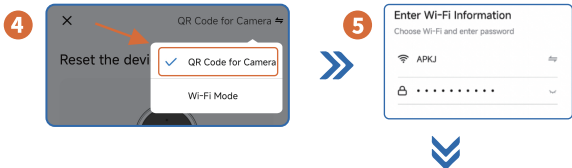

▲ Note:

The QR code on the phone screen needs to be at the same height as the camera and at a distance of 6-8in. Move back and forth from far to near for better recognition of the QR code.

Method 3 Wi-Fi Mode Connection

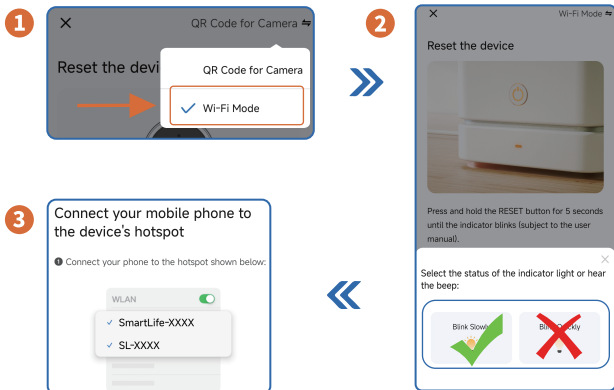

APP Function Introduction

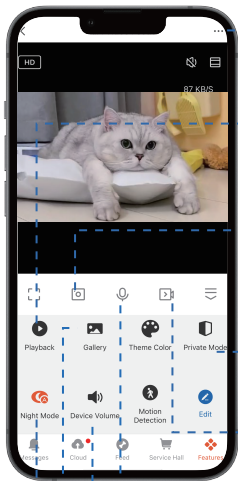

Set up:

- Changing the device name
- Share Device
- IPC PC Client

Playback:

Examine past video footage. You have the option to utilize a TF card or buy cloud storage.

Screenshot:

Take a screenshot of the screen and the screenshot will be saved in an Gallery.

Private Mode:

Set the camera to sleep mode.

Video:

Click to record video, and click again to end video recording.

Voice Calls:

- One-Way Communication
- Two-Way Talk

Device Volume:

Adjust the feeder's volume.

Gallery:

Save screenshots or recorded videos.
(Can process files in batches)

Night Mode:

Night Vision

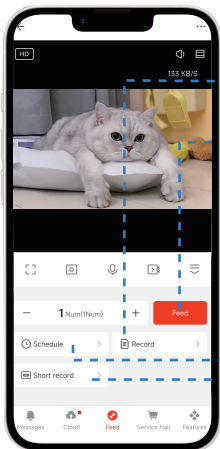

Record: Feeding history can be viewed.

Manual Feeding:
Up to 20 portions per click.

Schedule:
Daily feeding schedule can be set up for up to 15 meals.
(When setting, be sure to select the date)

Short Record:
Click to start recording sound and click again to stop recording sound.
(Need to be close to the feeder to record)

One-Way Communication (Default Mode):



Hold the talk button to speak, release the button to end the talk.

Two-Way Talk:



Click the button to talk, and when it's time to end the call, click the button again.

IPC Terminal

Step 1: Enter in your browser: <https://protect-us.ismartlife.me>

Step 2: Scan the QR code to log in through the **Smart Life** app to use all functions.

Disassemble for Cleaning

We recommend to clean the feeder regularly for the health of your pet. The washable parts of the feeder are as follows: lid, food tank, meal splitter, stainless steel feeding bowl, bowl tray.

Washable Parts

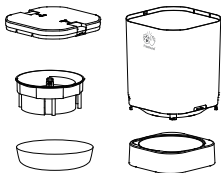

Do Not Wash

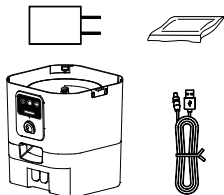

FAQ

Problem	Solution
Can't connect the feeder to WiFi.	1) Make sure Bluetooth, WLAN and GPS are turned on on your phone when connecting. (Can be turned off after successful connection)
	2) Try connecting with other connections method.
	3) The WiFi network may be unstable; please attempt to connect multiple times.
	4) It is advisable to connect the device near the router (ideally within 3 meters).
	5) Consider switching to a 2.4G network connection.
	6) Troubleshoot the router to see if it is working properly (try rebooting the router)
	7) Contact us through the contact form above and we will address your questions until they are resolved.

The WiFi connection goes off line frequently.	1) Make sure the feeder has a good signal within the WiFi coverage area.
	2) Check that the power cord is stably connected.
The feeder's camera can't read the QR code on your phone.	1) Ensure that the indicator light on the feeder is blinking blue.
	2) Try connecting using another connection method. The APP provides a variety of connection methods. (Follow the prompts in the APP)
	3) The QR code in the APP and the camera move back and forth at the same height.
Live video not showing.	1) Reconnect the feeder.
	2) Make sure the power cord is intact.
	3) Switch to stronger WiFi signal.
	4) If the network is poor, change the video quality from HD (high definition) to SD(standard definition).
Where are the photos and videos stored?	1) It's in the Gallery section of the Features function.