



# *PITT*

*COOKING*

*US User Manual*





## IMPORTANT SAFETY INSTRUCTIONS

READ AND SAVE THESE INSTRUCTIONS

**INSTALLER:** LEAVE THESE INSTRUCTIONS WITH THE APPLIANCE AFTER INSTALLATION IS COMPLETE.

**IMPORTANT:** SAVE FOR THE LOCAL INSPECTOR'S USE.

### WARNING:

Do not repair or replace any part of the appliance unless specifically recommended in the manuals. Improper installation, service or maintenance can cause injury or property damage. Refer to this manual for guidance. All other servicing should be done by a qualified technician.

### Gas Appliance Safety

#### WARNING:

If the information in this manual is not followed exactly, a fire or explosion may result causing property damage, personal injury or death.

- Do not store or use combustible materials, gasoline or other flammable vapors and liquids in the vicinity of this or any other appliance.
- **WHAT TO DO IF YOU SMELL GAS**
  - Do not try to light any appliance.
  - Do not touch any electrical switch.
  - Do not use any phone in your building.
  - Immediately call your gas supplier from a neighbor's phone. Follow the gas supplier's instructions.
  - If you cannot reach your gas supplier, call the fire department.
- Installation and service must be performed by a qualified installer, authorized service agency or the gas supplier.

- Install a gas shutoff valve near the appliance. It must be easily accessible in an emergency.
- Leak testing must be conducted by the installer according to the instructions in this manual.
- The appliance and its individual shutoff valve must be disconnected from the gas supply piping system during any pressure testing at pressures in excess of psi (3.5 kPa).
- The appliance must be isolated from the gas supply piping system by closing its individual manual shutoff valve during any pressure testing of the gas supply piping system at test pressures equal to or less than psi (3.5 kPa)
- The minimum supply pressure must be 1" water column above the manifold pressure printed on the data plate.
- The maximum supply pressure must not exceed 14.0 inches water column (34.9 Millibars).
- For Massachusetts installations:
  - Installation must be performed by a qualified or licensed contractor, plumber or gas fitter qualified or licensed by the state, province or region where this appliance is being installed.
  - Shut-off valve must be a "T" handle gas cock.
  - Flexible gas connector must be new and not longer than 36 inches
- Installer - show the owner where the gas shut-off valve is located.

### Propane Gas (LP) Installation

- The propane (LP) gas tank must be equipped with its own high pressure regulator. In addition, the regulator supplied with this unit must also be used.
- The appliance must be marked on the data plate on the back side of the appliance with: "Gas type: G31 LP".

---

## Equipment and Usage Safety Requirements

- The cooktop must be used in conjunction with a suitable ventilation system.
- Remove all tape and packaging before using the appliance. Destroy the packaging after unpacking the appliance. Never allow children to play with packaging material.
- Never modify or alter the construction of the appliance. For example, do not remove panels, wire covers or screws.
- To eliminate the risk of burns or fire by reaching over heated surface units, cabinet storage space located above the surface units should be avoided. If cabinet storage is to be provided, the risk can be reduced by installing a hood that projects horizontally a minimum of 5 inches beyond the bottom of the cabinet.
- Verify that cabinets above the cooktop are a maximum of 13" (330 mm) deep.

## Appliance Handling Safety

- Unit is heavy and requires at least two people or proper equipment to move.
- Hidden surfaces may have sharp edges. Use caution when reaching behind or under appliance.

## Safety Codes and Standards

- This appliance complies with one or more of the following Standards:
  - ANSI Z21.1, The American National Standard for Household Cooking Gas Appliances
  - CAN/CSA-C22.2 No. 61-M89 Household Cooking Ranges
- It is the responsibility of the owner and the installer to determine if additional requirements and/or standards apply to specific installations.
- Installation must conform with local codes or, in the absence of local codes, with the National Fuel Gas Code, ANSI Z223.1/NFPA 54.
- The appliance must be electrically grounded in accordance with local codes or, in the absence of local codes, with the National Electrical Code ANSI/ NFPA 70, latest edition. (In Canada, installation must be in accordance with the CAN 1-B149.1 and .2 Installation Codes for Gas Burning Appliances and/ or local codes).

## Electric Safety

- Before you plug in an electrical cord, be sure all controls are in the OFF position.
- For appliances equipped with a cord and plug, do not cut or remove the ground prong. It must be plugged into a matching grounding type receptacle to avoid electrical shock. If there is any doubt as to whether the wall receptacle is properly grounded, the customer should have it checked by a qualified electrician.
- This appliance should be installed in accordance with the National Electric Code or Canadian Electrical Code. It is required that the cooktop be installed on a grounded, non-GFCI branch circuit.
- Installer - show the owner the location of the circuit breaker or fuse. Mark it for easy reference.
- Important - Save these instructions for the local electrical inspector's use.
- Before installing, turn power OFF at the service panel. Lock service panel to prevent power from being turned ON accidentally.
- Be sure your appliance is properly installed and grounded by a qualified technician. Installation, electrical connections and grounding must comply with all applicable codes.

## High Altitude Installation

This range is CSA certified for safe operation up to an altitude of 10,000 ft. without any modifications (except LP conversion, when applicable).

## **Content**

---

<b>Chapter</b>	<b>Subject</b>	<b>Page</b>
1	Installation dimensions	3
2	Connection: gas and electrical	4
3	General instructions	6
4	Control PITT® cooking	7
5	Optimal use of the PITT® cooking system	7
6	Maintenance of the PITT® cooking system	8
7	Failures in the PITT® cooking system	9
8	Models overview	10
9	Packaging	11
10	Service addresses	26

## **Foreword**

---

Dear customer,

Congratulations on the purchase of your PITT® cooking gas hob. This unique system gives you the opportunity to determine the location of each burner which means you are guaranteed to cook with pleasure for many years. Thanks to the various burner capacities you can properly prepare each dish and the integrated spark ignition in the controls ensures that the burners can be handled with one hand. This manual describes how to take full advantage of all the features of this gas hob.

We recommend you read the user manual and mounting instructions carefully before you use the gas hob.

Do not throw this manual away, so that any following user also benefits from it.

Happy Cooking!

PITT® cooking

# 1 Installation dimensions

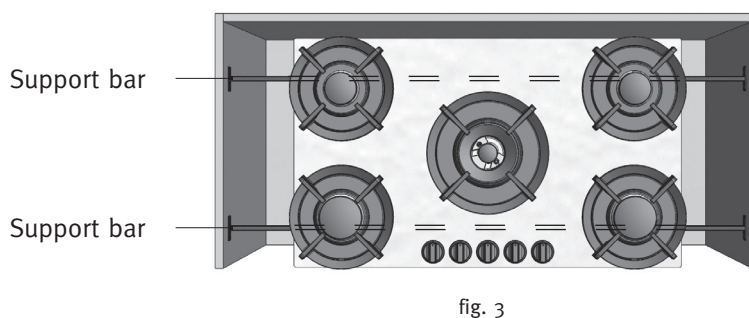
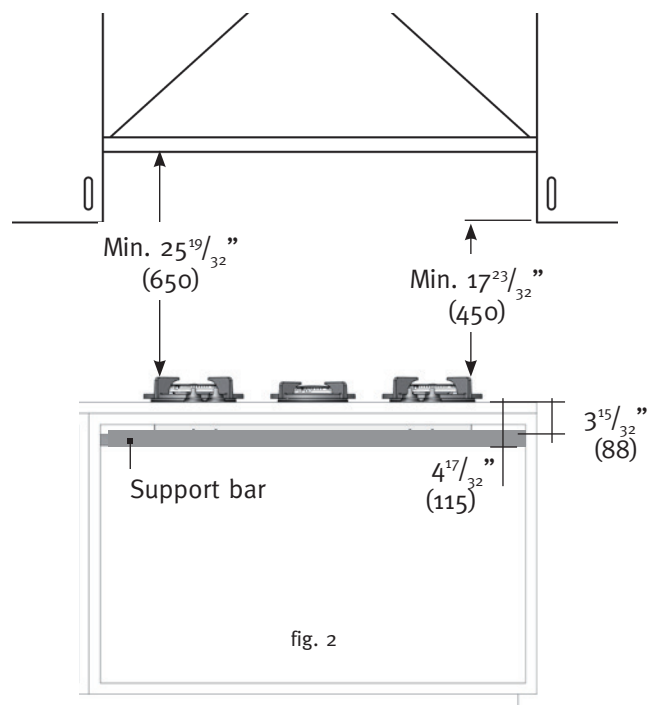
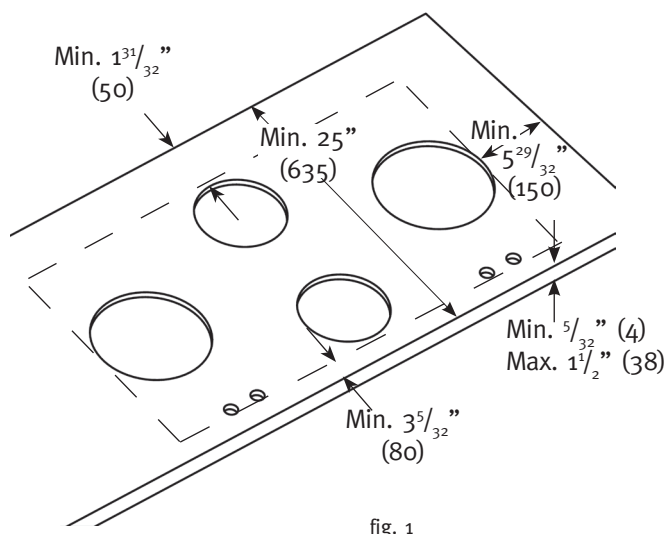

- A cooking module cannot be installed over a partition of cabinets. It has to be accessible in case it needs servicing.
- When PITT® cooking is combined with a drawer cabinet, always be aware of the measurements of the unit and the support bar. The height of the unit and the support bar is  $4\frac{17}{32}$  in (115 mm) measured from the top of the worktop (fig.2).
- To prevent bending of the worktop the appliance need to be supported by two PITT® cooking support bars (fig. 2 and 3).

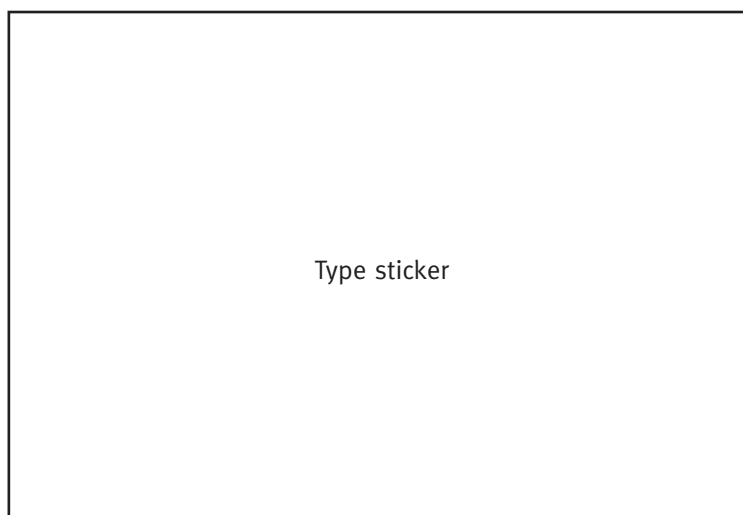

## 2 Connection: gas and electrical

### Gas connection instructions

- Check that installation or local distribution regulations (type of gas and gas pressure) match the setting value of this device.
- The setting values of this device are indicated on the type plate.
- This device is not equipped with a combustion gas drain installation. Installation and connection must comply with the regulations in force locally and nationwide. You must check the regulations in regards to ventilation requirements.
- The gas connection must comply with the general regulations. We recommend to connect the hob with a fixed gas pipeline or to use an approved gas hose.
- Install the pressure regulator (fig 4a) (supplied with unit) to manifold pipe using pipe-joint compound (resistant to LP and Natural gas) on threads of manifold pipe. Turn to hand tighten plus 1/4 turn, not exceeding 1 turn for alignment. To prevent possible damage to the gas pressure regulator, install it after the appliance is in its permanent position. When the regulator is securely installed on the manifold pipe, the conversion nut will be easily accessible.
- Always use a full metal hose behind the oven.
- An approved gas hose should not be kinked and should not come into contact with moving parts of the kitchen furniture.
- The main gas supply must be in an easily accessible place.
- Before using the cooking unit check all the connections for leaks with a soap solution.

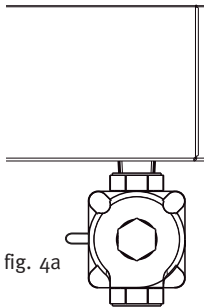

**Caution:** Do not attempt any adjustment of the pressure regulator, except conversion to propane.

### Electrical connection instructions\*

120 V – 60 Hz – 0,6 VA

- The electrical installation must conform to the national and local regulations.
- Power socket and plug must always be reachable.
- Connect the unit with the supplied plug to an earthed socket.
- Damage to the connection cable may only be replaced by the manufacturer, or an approved Installer. This to prevent dangerous situations.

### Battery spark ignition\*

1,5V DC

- The spark ignition operates through a battery AA.
- The battery is positioned in the casing at the underside.
- Replace the battery if the spark ignition does not operate

\* Depending on the model

### Models PITT® cooking overview

Model PITT	Artikel nr.	Totaal Btu/h
Akan	PITT 1-2-2	6142
Altar	PITT 1-3-2	10236
Air	PITT 1-5-1	17061
Azuma	PITT 1-5-2	17061
Baluran	PITT 2-53-1	27297
Bennett	PITT 2-25-1	23203
Baula	PITT 2-53-2	23203
Bely	PITT 2-25-2	23203
Capital	PITT 3-325-1	33439
Cima	PITT 3-532-1	33439
Cusin	PITT 3-535-1	44358
Dempo	PITT 4-5325-1	50500
Danau	PITT 4-5325-2	50500
Drum	PITT 4-5325-3	50500
Ebeko	PITT 5-32325-1	49817
Elbrus	PITT 5-32532-1	49817
Enep	PITT 5-53232-1	49817
Foessa	PITT 6-532325-1	66878

### Gastype - nozzle combination overview

Gas	Supply pressure	Burner 6142 Btu/h nozzle	Burner 10236 Btu/h nozzle	Burner 682 - 17061 Btu/h outer ring nozzle	Burner 682 - 17061 Btu/h inner ring nozzle
Nat.	4" 10 mbar	1.16 mm	1.50 mm	2x 1.43 mm	1x 0.80 mm
LP	10" 27,4 mbar	0.73 mm	0.94 mm	2x 0.50 mm	1x 0.83 mm

### Unit category

Gas	Nat.	LP		
Supply pressure	4" 10 mbar	10" 27,4 mbar		

**Class of appliances: 3**

#### Safety Warnings

Read the instructions in this user manual carefully. Only then you can use your PITT® cooking gas hob the right way.

Save both the Assembly instructions and the user manual. If the PITT® cooking system transfers to another user, they need this documentation.

Check the PITT® cooking system immediately after removing the packaging. If there is any shipping damage you should contact PITT® cooking immediately by e-mail or in writing.

#### Safety Rules

1. PITT® cooking is intended for domestic use only.
2. Only use the gas hob for the preparation of dishes. This appliance is not suitable for heating your home.
3. Please ensure that all burner parts are placed correctly.
4. Ensure adequate ventilation during use.
5. Distance from the pan to a non-heat resistant wall or control knob must be at least 2 cm or 0,8 inches.
6. Always place pans on the pan support, never directly on the burner top.
7. Check the product regularly for damage. Do not use the product when damaged, repair it immediately.
8. The user is responsible for the proper use and good state of the system.  
When used incorrectly, the manufacturer is not liable for any damages.

#### OVERHEATING AND FIRE HAZARDS

9. Use the burner only with a pan or a wok on the pan support. Warning: an empty pan may overheat.
10. Overheated oil or butter can easily ignite. Never put out with water. You can smother the flames by closing the pan with a lid.
11. Do not flambé under a cooker hood, this can cause a fire.
12. Never put flammable objects on the hob.
13. Never place a grill or griddle over two burners.
14. Do not use pans with a larger base diameter than the pan support. We recommend for the 2 and 3KW burners a pan with a maximum base diameter of 230 mm and for the 5KW burner a maximum base of 270 mm.

#### HOT PARTS

15. Parts of the burner and the worktop surrounding the burner may become hot during use and will remain hot for a long period after use. Please take care not to touch these parts until they have fully cooled.
16. Please be aware that if you use a pan with a larger base diameter than the pan support (see point 14) there is a possibility that the control knobs may become hot.
17. Please be aware that the flame should always remain beneath the base of the pan (unless you are stir frying with a wok). Flames rising against the side of the pan will not be effective and will produce unwanted overheating.
18. It is very important that children remain at a distance.
19. Check operation of electric igniters. Check flame characteristics. Flame should be blue with no yellow tip:

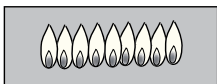

#### **Yellow Flames:**

Further adjustment is required.

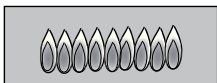

#### **Yellow Tips on Outer Cones:**

Normal for LP Gas.

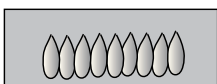

#### **Soft Blue Flames:**

Normal for Natural Gas.

If the flame is completely or mostly yellow, verify that the regulator is set for the correct fuel. After adjustment, retest.

Some yellow streaking is normal during the initial start-up. Allow unit to operate 4-5 minutes and re-evaluate before making adjustments.

## 4 Control PITT® cooking

### Burners PITT® cooking



1023 - 6142 Btu/h



1023 - 10236 Btu/h

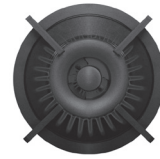

682 - 17061 Btu/h

### Burners ignite and set

Before you ignite the burner verify that all components are mounted in the right way to prevent unwanted interference. Before igniting the burner you need to place a pan on the hob. Each burner can be set easily between high and low.

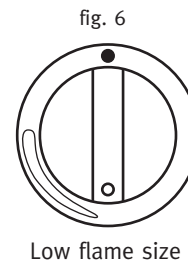
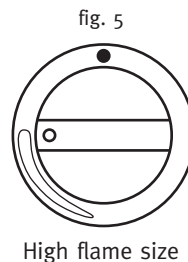
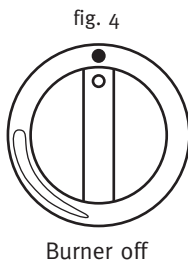

#### IGNITING

To ignite the burner you need to activate the spark ignition. You do this by pressing the control knob all the way and hold. Turn the control knob to the left (Figure 5). Keep the button pressed for another 5 to 8 seconds. This way the temperature sensor warms and gas can be distributed. You can regulate the size of the flame by turning the control knob slowly between the high and low position (Figure 5 and 6).

**Caution:** If the flame does not ignite after 2 to 4 seconds, you need to return the knob to the low position (Figure 6). A small flame often kindles faster than a large flame.

#### TURNING OFF

To turn off the burner, turn the control knob back to the state displayed on Figure 4.

## 5 Optimal use of the PITT® cooking system

- Avoid flames rising around the pan to minimise the loss of energy. Be careful as the handles of the pans can become hot.
- To cook large quantities you best use the stir-fry cooker. For preparation of sauces and simmering dishes best use the side burner. To cook through it should be on the highest level.
- Cooking with the lid on the pan conserves energy.
- Use cookware with a flat, clean and dry bottom. Flat pans are more stable and a clean bottom makes for a better heat transfer.

### High burner

With the cooker you can prepare dishes at a very high temperature. It is important, however, to pay attention to a number of things:

- Make sure you have the ingredients cut in advance.
- Use an oil of good quality for frying, for example: olive oil, sunflower oil or peanut oil. Do not use butter or margarine as these will be overheated and blackened by high temperatures.
- To ensure all the ingredients are ready at the same time, you must put the ingredients with the longest preparation time in the pan first.

## 6 Maintenance of the PITT® cooking system

PITT® cooking is manufactured with high-grade materials, which can be very easily cleaned.

Please take the following into consideration:

1. Never clean in the dishwasher as the detergent can affect the materials. Avoid cleaning with too much moisture as the can enter the burner outlet and cause damage.
2. Use a cloth to clean the electric spark ignition (fig. 7). In case of heavy use it can be cleaned with the point of a fine brush. Do this carefully as an accidental change in the distance between the burner and spark ignition may result in the burner being damaged or failing to ignite.
3. Place the pan support directly onto the burners without scratching your countertop.
4. Assemble the burner parts via the centring cams in each part (see fig. 8).
5. Clean the cooker immediately after use. This prevents overcooked food settling on the burner and becoming difficult to remove.
6. Start with cleaning the buttons, burners and pan support. Then clean the countertop to prevent it from being stained again.
7. Use a mild detergent and a soft cloth to clean the removable burner parts. Stubborn stains on pan carriers and burner tops are best removed with a liquid cleanser.
8. Never use scouring powders, pads, sharp objects or aggressive cleaning agents.
9. For maintenance and cleaning of the countertop refer to the manual of the particular product.

**Caution:** The PITT® cooking system must not be steam cleaned or high-pressure cleaned. If cleaned this way the electrical safety is not ensured.

**Caution:** Never unscrew the screws of the heat shield(s) (see fig. 8a).

fig. 7

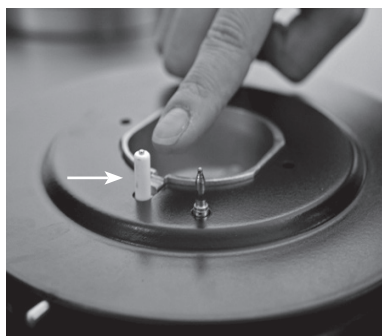

Electric spark ignition

fig. 8

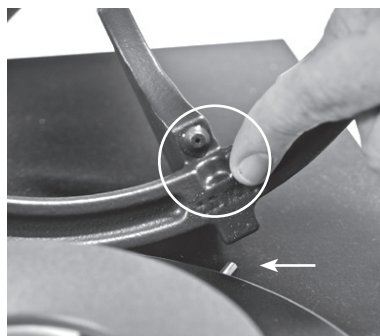

Pan support with centering cams

fig. 8a



Screws heat shield

## 7 Failures in the PITT® cooking system

**Note:** the PITT® cooking-system may only be connected by an approved installer. To ensure the safety and warranty repairs may only be performed by approved professionals. You should only use original parts.

Failure	Cause	Solution	Chapter / Page
A burner ignites and turns off again.	The control knob is not pressed long enough to activate the auto-flame detection.	Press the control knob down long enough to turn between full and low heat.	Chapter 4 / page 7
	The control knob is not adjusted at the correct height.	Adjust the control knob properly.	Installation manual step 13 t/m 15.
The control-button touches the sealing scale.	Hob is not mounted the right way under the countertop.	Adjust the control knob properly.	Installation manual step 13 t/m 15.
	Sealing scale is not in the center vs. control knob.	Detach sealing scale and and re-stick again.	Installation manual step 20 t/m 21.
Spark ignition remains igniting.	Hob is not mounted the right way under the countertop.	Adjust the control knob properly.	Installation manual step 13 t/m 15.
	Sealing scale is not in the center vs. control knob.	Detach sealing scale and and re-stick again.	Installation manual step 20 t/m 21.
The burner doesn't ignite.	The control knob is not adjusted at the correct height.	Adjust the control knob properly.	Installation manual step 13 t/m 15.
	The power plug is not in the power socket.	Put the power plug into the power socket.	
	Fuse malfunction / fuse in meter cupboard is disabled.	Install a new fuse or switch on the fuse again.	
	Spark ignition is dirty or wet.	Clean or dry the spark ignition.	Chapter 6 / page 8
	Burner parts are not properly mounted.	Ensure the burner parts are correctly aligned with the centring cams.	Chapter 6 / page 8
	Burner parts are dirty or wet.	Clean or dry the burner parts. Make sure the outflow holes are open.	Chapter 6 / page 8
	The main gas supply is not open.	Open the main gas supply.	
	The control knob is not pressed long enough	Press the control knob down long enough to turn between full and low heat.	Chapter 4 / page 7
Battery empty*	Replace battery	Chapter 2 / page 4	
A burner does not burn evenly.	Burner parts are not placed properly.	Ensure the burner parts are correctly aligned with the centring cams.	Chapter 6 / page 8
	Burner parts are dirty or wet.	Clean or dry the burner parts. Make sure the outflow holes are open.	Chapter 6 / page 8
Gas smell.	Gas connection leaks.	Check the connection. Turn main gas supply off immediately when you're not able to fix it right away.	
	There is a burner turned on, but not inflamed.	Close the control knob and wait a few minutes before reigniting.	Chapter 4 / page 7

\* Depending on the model

If the failure still remains please contact your dealer or the PITT® cooking customer service: See the service addresses on page 14.

# 8 Models overview

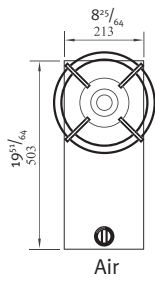

Air

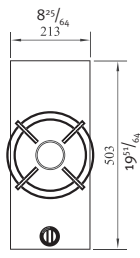

Akan

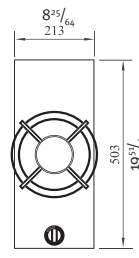

Altar

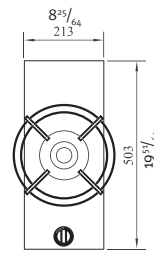

Azuma

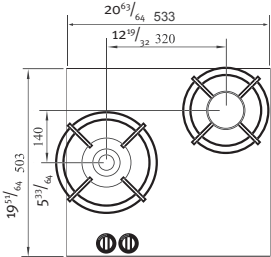

Baluran

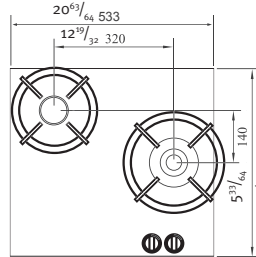

Bennett

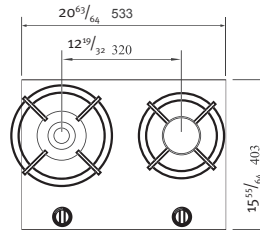

Baula

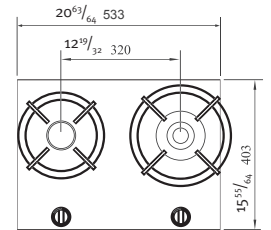

Bely

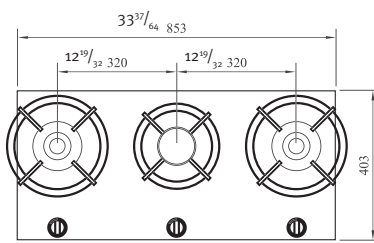

Cusin

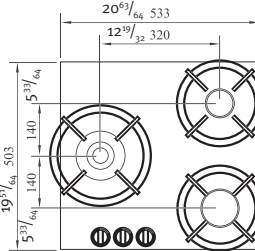

Cima

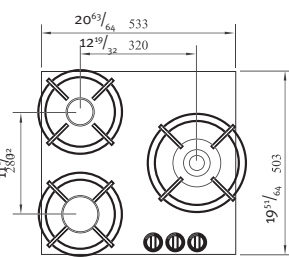

Capital

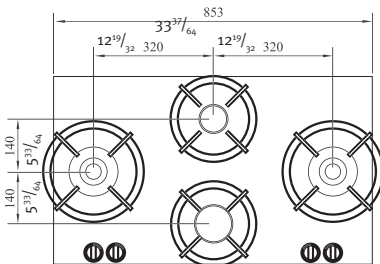

Dempo

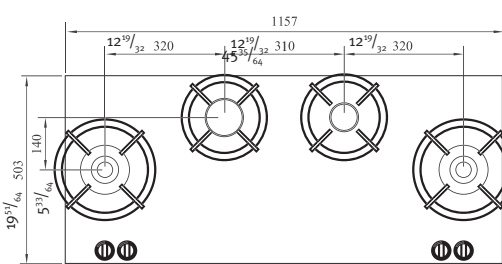

Drum

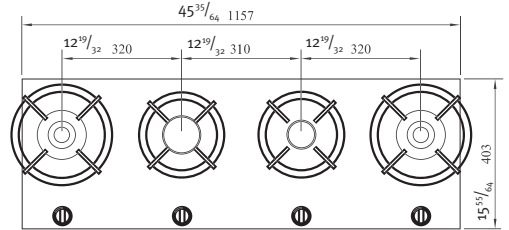

Danau

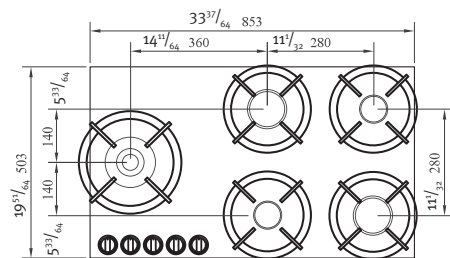

Enep

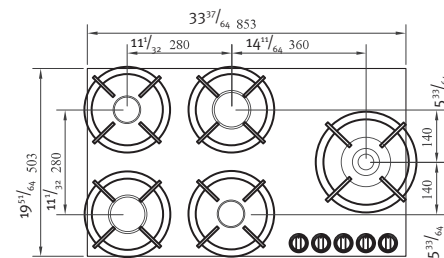

Ebeko

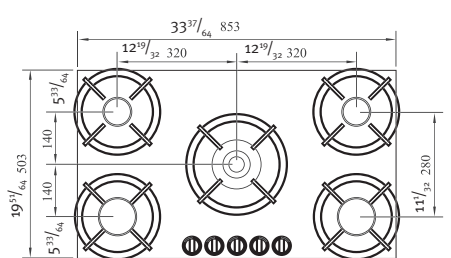

Elbrus

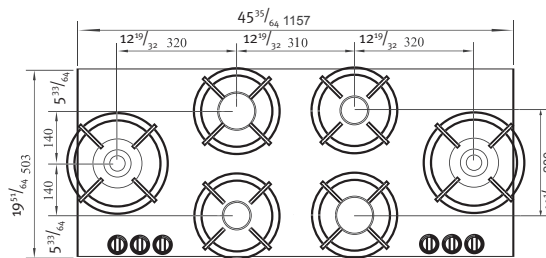

Foessa

## 9 Packaging

---

The PITT® cooking system is manufactured using sustainable materials. The packaging is recyclable and consists of the following types of materials:

- paperboard
- paper

These materials are in accordance with the provisions of Government to be disposed of in a responsible manner. The packaging of this product is equipped with a sticker with the image of a crossed-out dustbin (see Figure 9).

afb. 9



*The directive on waste electrical and electronic equipment (WEEE) of the European Union. The WEEE directive of the European Union requires that products that are sold in the countries of the EU (or in some cases the packaging thereof) must be labelled with a crossed-out dustbin. As determined by the WEEE directive, this means label with the crossed-out dustbin that customers and end users in the countries of the EU electrical and electronic equipment or accessories not with the garbage may dispose. Customers and end users within the EU should contact their local supplier or maintenance centre for information about the waste collection system in their municipality.*





## *Made in Holland*

---

PITT® cooking systems  
209 River Road Extension  
Cos Cob, CT 06807  
T-203 900 1124  
F-203 698 9425  
[info@pittcookingsystems.com](mailto:info@pittcookingsystems.com)  
[www.pittcookingsystems.com](http://www.pittcookingsystems.com)