

Goldair™



Operating Instructions

2000W Convector Heater with Turbo Fan



Model: GCV325

This page has intentionally been left blank.

General Care and Safety Guide

YOUR SAFETY IS IMPORTANT TO US. PLEASE ENSURE YOU TAKE NOTE OF THE INSTRUCTIONS AND WARNINGS OUTLINED IN THIS MANUAL.

CAUTION: In order to avoid a hazard due to inadvertent resetting of the thermal cut-out, this appliance must not be supplied through an external switching device, such as a timer, or connected to a circuit that is regularly switched on and off by the utility.

- This appliance is not intended for use by persons (including children) with reduced physical, sensory or mental capabilities or lack of experience and knowledge, unless they are supervised or have been given instruction concerning the use of the appliance by a person responsible for their safety.
- Children should be supervised to ensure that they do not play with the appliance.
- If the supply cord is damaged, it must be replaced by the manufacturer, its service agent or similarly qualified persons in order to avoid a hazard.

WARNING: You must not cover this heater. Covering this heater presents fire risk and will activate the safety fuse; permanently disabling the unit.

WARNING: Do not use this heater in small rooms when they are occupied by persons not capable of leaving the room on their own, unless constant supervision is provided.

WARNING: To reduce the risk of fire, keep textiles, curtains, or any flammable material a minimum distance of 1 metre from the air outlet.

- Use only the voltage specified on the rating label of the appliance.
- The heater must not be located immediately below a socket outlet.
- Keep all objects at least 1 metre from the front, sides and rear of the appliance.
- This appliance is intended for household use only and not for commercial or industrial use.
- Indoor use only.
- Use this appliance only as described in this manual. Any other use is not recommended by the manufacturer and may cause fire, electric shock or injury.
- Do not use the heater if it has been dropped or damaged.
- The common cause of overheating is deposits of dust or fluff in the appliance. Ensure these deposits are removed regularly by unplugging the appliance and vacuum cleaning the air vents and grills.
- Always unplug appliance when not in use.
- When the appliance has been unpacked, check it for transport damage and ensure all parts have been delivered. If parts are missing or the appliance has been damaged, contact the Customer Services Team.
- Do not use if there are visible signs of damage to the heater.

General Care and Safety Guide

- **Never use the appliance to dry clothes.**
- Do not connect the appliance to mains supply until completely assembled and adjusted.
- Ensure hands are dry before handling the plug or main unit.
- Ensure heater is on a flat, stable, heat-resistant surface.
- Do not operate with cord set coiled up as a heat build up is likely, which could be sufficient to become a hazard.
- Carry out regular checks of the supply cord to ensure no damage is evident
- Do not operate this appliance with a damaged cord, plug or after the appliance malfunctions or has been dropped or damaged in any manner. Return to a qualified electrical person for examination, electrical service or repair.
- Do not twist, kink or wrap the cord around the appliance, as this may cause the insulation to weaken and split. Always ensure that all cord has been removed from any cord storage area and is unrolled before use.
- It is recommended that this heater is plugged directly into the wall socket. Power boards are not rated to supply power to high wattage appliances.
- A correctly specified, undamaged extension cord may be used with this heater provided it is used in a safe manner.
- Do not remove plug from power socket until the appliance has been switched off.
- Do not remove plug from power socket by pulling cord; always grip plug.
- Do not place cord under carpet or cover with rugs or furniture. Arrange the cord so it cannot be tripped over.
- Don't place appliance on bedding or on thick & long carpet where the openings may get blocked.
- Switch off and use handle provided when moving
- Do not place appliance close to radiant heat source.
- Do not insert or allow foreign objects to enter any ventilation or exhaust opening, as this may cause an electric shock, fire or damage to the appliance.
- Do not sit on the appliance.
- Do not use abrasive cleaning products on this appliance. Clean with a damp cloth (not wet) rinsed in hot soapy water only. Always remove plug from the mains supply before cleaning.
- Do not operate in areas where petrol, paint or other flammable liquids are used or stored.
- Do not use this appliance in the immediate surrounds of a bath, a shower, or a swimming pool or other liquids.
- The appliance must not be immersed in any liquids.
- There are no user serviceable parts installed in the unit.
- Do not place the unit in wardrobes or other enclosed spaces as this may cause fire hazards.
- This unit is not supposed to be used in or around locations where foodstuffs, works of art or delicate articles of science, etc. are stored.
- If your appliance does not work, or is not working properly, contact the place of purchase or the Customer Services Team.

Assembling your Convector Heater



Main Body x 1

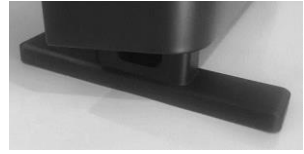

Feet x 2



Screw Pack x 1

WARNING: Heater must not be used without the feet fitted.

This appliance has been supplied with '1 way screws' for permanent installation of the feet. This is a safety requirement for the New Zealand and Australian market.

Before using the heater, the feet (supplied separately in the carton), must be fitted to the unit.

1. Carefully turn the Main Body upside-down on a scratch-free and stable surface. Be careful to prevent damage to the cosmetic finish or your floor surfacing.
2. Attach the feet to the base of the heater by aligning the built-in position pins with the position holes on the base of the heater and fixing a screw into the hole between the two position holes. Use two screws for each foot.

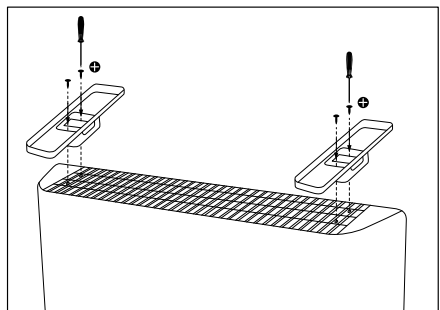
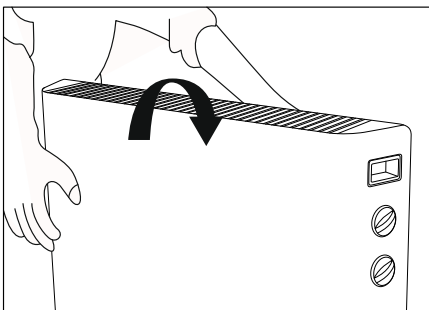

Operating your Convector Heater

WARNING: In order to avoid overheating or fire, do not cover the heater.

WARNING: Keep all objects at least 1 metre from the front, sides and rear of the appliance.

WARNING: Do not use this heater with a programmer, separate timer, remote-control system or any other device that switches the heater on automatically, since a fire risk exists if the heater is covered or positioned incorrectly.

WARNING: Never leave this heater unattended.

Ensure heater is on a flat, stable, heat-resistant surface.

Once the heater is in a safe operating position and all switches are in the off position, insert the power plug into the mains outlet.



CAUTION: Ensure the power cord is not tight because if pulled it may partially pull the plug from the socket. A partially inserted plug will overheat the plug and socket and could result in fire.

PLEASE NOTE: As this product is fitted with a Timer, the Timer has been set to the "ON" position. Please refer to the Timer section for setting instructions.

Operating your Convector Heater

Always choose a safe location for the heater, keeping in mind the safety precautions outlined. Ensure all packaging has been removed from the unit before use. This appliance requires no installation, it should be used solely as a portable appliance.

HEATER CONTROL SWITCH

| | |
|---|----------------------|
| O | OFF |
| I | 1250W |
| II | 2000W |
| I  | 1250W with Turbo Fan |
| II  | 2000W with Turbo Fan |

Check that the heat control switch is set to Off position before plugging the appliance into the mains supply.

For greater economy, use the High Heat setting initially and then switch to the Low Heat setting.

For the Low and High Heat settings the fan remains at the same speed; only the wattage changes to create the greater/lesser heat output.

THERMOSTATIC CONTROL

1. Rotate thermostat knob clockwise until you reach the maximum position.
2. When the room reaches a temperature that is comfortable for you, slowly turn the knob anti-clockwise until the heater just turns off (you will hear a click).
3. The heater will now cycle on and off to maintain the comfort level you have set.
4. Take note of this setting position for future use.

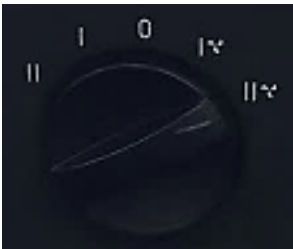

HEATER CONTROL SWITCH



THERMOSTATIC CONTROL

Operating your Convector Heater

SAFETY DEVICES

This appliance has two protection devices:

- Tilt Switch - this will automatically turn the appliance off if the appliance is not in the correct operating position.
- Resettable Thermal Link - this will automatically disconnect the power to the appliance at a pre-set overheat temperature. After cooling down it will reset and power on again. If this occurs, investigate what is causing the appliance to overheat.
- Thermal Fuse - this disconnects the appliance permanently in case of overheating. (It is non resettable).

CAUTION: The heater generates heat during use. Proper precautions must be taken to prevent the risk of burns, scalds, fires or other damage to persons.

CARE AND CLEANING

- The heater requires regular cleaning to ensure trouble free operation:
- Unplug the heater from the mains supply before cleaning.
- Ensure that the heater has been allowed to cool down completely before cleaning.
- The common cause of overheating is deposits of dust or fluff in the appliance. Ensure these deposits are removed regularly by unplugging the appliance and vacuum cleaning the air vents and grills.
- Use a damp cloth (not wet) to wipe the exterior of the heater to remove dust and dirt.
- Never use solutions such as petrol, thinners or polishing agents.
- Ensure the heater is dry before plugging back into the mains supply.
- Do not attempt to dismantle the appliance.
- There are no user serviceable parts. For service or repair, contact an authorised electrical service technician

PROOF OF PURCHASE

To receive warranty retain receipt as proof of purchase.

| | |
|---|---|
| Goldair Model No: CV0732 Item No: (GCV325) Supply: 220-240VAC 50-60Hz Wattage: 1800-2000W Approval: SAA-200012-EA QC Passed: PO#-WWYY MADE IN CHINA CUSTOMER SUPPORT NEW ZEALAND PH: 0800 232 633 AUSTRALIA PH: 1300 465 324 |  |
|---|---|

Goldair™

SUPPORT AND TECHNICAL ADVICE

Goldair – New Zealand

Monday – Friday 8am-5pm

Phone +64 (0)9 917 4000

Phone 0800 232 633

info@cdb.co.nz

Goldair – Australia

Monday – Friday 8am-5pm

Phone +61 (0)3 9365 5100

Phone 1300 465 324

info@cdbgoldair.com.au



Two Year Warranty

Thank you for purchasing this Goldair product. Your product is warranted against faults and manufacture when used in normal domestic use for a period of **two years**. In non-domestic use Goldair limits the voluntary warranty to **three months**.

Goldair undertake to repair or replace this product at no charge if found to be defective due to a manufacturing fault during the warranty period.

This warranty excludes damage caused by misuse, neglect, shipping accident, incorrect installation, or work carried out by anyone other than a qualified electrical service technician.

PLEASE KEEP YOUR RECEIPT AS THIS WILL HELP VERIFY YOUR WARRANTY.

The benefits given to you by this warranty are in addition to other rights and remedies available to you under law in relation to the goods or services to which this warranty relates.

In Australia, our goods come with guarantees that cannot be excluded under the Australian Consumer Law. You are entitled to a replacement or refund for a major failure and compensation for any other reasonably foreseeable loss or damage. You are also entitled to have the goods repaired or replaced if the goods fail to be of acceptable quality and the failure does not amount to a major failure.

In New Zealand this warranty is additional to the conditions and guarantees of the Consumers Guarantee Act (1993).

Goldair – New Zealand

CDB Goldair
PO Box 100-707
N.S.M.C
Auckland

Phone +64 (0)9 917 4000
Phone 0800 232 633
www.goldair.co.nz

Goldair – Australia

CDB Goldair Australia Pty
PO Box 574
South Morang
Victoria, 3752

Phone +61 (0)3 9365 5100
Phone 1300 GOLDAIR (1300 465 324)
www.goldair.com.au

Goldair Two Year Warranty (IMPORTANT: Please complete and retain this warranty card)

Name _____

Address _____

Place Of Purchase _____ Date Of Purchase _____

Name Of Product _____ Model Number _____

Attach a copy of the purchase receipt to this warranty card



This page has intentionally been left blank.

This page has intentionally been left blank.

Goldair™



CDB  Goldair™

New Zealand
PO Box 100707,
North Shore Mail Centre,
Auckland, 0745
www.goldair.co.nz

Australia
PO Box 574,
South Morang,
Victoria, 3752
www.goldair.com.au