

VEVOR

Affordable. Reliable. Home Improvement.

SHOWER PANEL TOWER

MODEL:

6002FL、8039FL、7009FL、6012FL、8124FL、7016FL、7002FL、7015FY

Technical Support and E-Warranty Certificate

www.vevor.com/support

VEVOR

SHOWER PANEL TOWER

Affordable. Reliable. Home Improvement.



6002FL
6012FL

8039FL

8124FL



7009FL

7016FL

7002FL

7015FY

This is the original instruction, please read all manual instructions carefully before operating. VEVOR reserves a clear interpretation of our user manual. The appearance of the product shall be subject to the product you received. Please forgive us that we won't inform you again if there are any technology or software updates on our product.

	<p>Warning-To reduce the risk of injury, user must read instructions manual carefully.</p>
	<p>This device complies with Part 15 of the FCC Rules. Operation is subject to the following two conditions:(1)This device may not cause harmful interference, and (2)this device must accept any interference received, including interference that may cause undesired operation.</p>
	<p>This product is subject to the provision of European Directive 2012/19/EC. The symbol showing a wheeled bin crossed through indicates that the product requires separate refuse collection in the European Union. This applies to the product and all accessories marked with this symbol. Products marked as such may not be discarded with normal domestic waste, but must be taken to a collection point for recycling electrical and electronic devices</p>

INSTRUCTIONS

Warning Tips:

1. During the installation process, it is best to wear gloves to prevent sharp corners on the panel from scratching the palm of the hand.
2. When installing the shower, ensure that all joints are fully tightened to avoid water leakage.
3. Ensure that the red and blue water inlet pipes inside the panel are in a non folded state to avoid affecting water pressure.
4. When the shower is not in use, please close the switch valve of the shower.















SAVE THESE INSTRUCTIONS

INSTALLATION INSTRUCTIONS

Model	6002FL	8039FL	6012FL	8124FL	7009FL	7016FL	7002FL	7015FY
Mounting Type	Wall Mount							
Connection Thread	G1/2"							
Functions	Four Modes	Six Modes	Five Modes	Five Modes	Five Modes	Three Modes	Four Modes	Four Modes
Tub Spout	√	√	√	√	√	×	√	√
Temperature Display	×	√	×	×	√	×	√	×
LED Lamp	√	√	√	√	×	×	×	×
Power	Dry Cell (DC3V)	Dry Cell (DC3V)	Dry Cell (DC3V)	Dry Cell (DC3V)	Dry Cell (DC3V)	×	Dry Cell (DC3V)	×
Hand Shower	1-Setting	3-Setting	1-Setting	1-Setting	3-Setting	5-Setting	1-Setting	1-Setting
Finish	Fingerprint-free Brushed Nickel shower system							Black-Painting
Material	304 Stainless Steel, Brass, PVC, ABS		201 Stainless Steel, Brass, PVC, ABS		304 Stainless Steel, Brass, PVC, ABS			

PARTS LIST

MODEL		8039FL	6002FL 6012FL 8124FL	7009FL	7016FL	7002FL	7015FY
Handheld Shower	 or 	1pcs	1pcs	1pcs	1pcs	1pcs	1pcs
1.5 Meter Hand Spray Hose		1pcs	1pcs	1pcs	1pcs	1pcs	1pcs
Hand Spray Seat		1pcs	1pcs	1pcs	1pcs	1pcs	0pcs
1/2 Right Angle Adapter		2pcs	2pcs	2pcs	2pcs	2pcs	2pcs
4-Point Rubber		2pcs	2pcs	2pcs	2pcs	2pcs	2pcs
Self Tapping Screw		4pcs	4pcs	4pcs	4pcs	4pcs	4pcs
Fastener		2pcs	2pcs	2pcs	2pcs	2pcs	2pcs
Grommet		1pcs	1pcs	1pcs	1pcs	1pcs	2pcs
Hexagon Nut		1pcs	1pcs	1pcs	1pcs	1pcs	1pcs

MODEL		8039FL	6002FL 6012FL 8124FL	7009FL	7016FL	7002FL	7015FY
M6 Nut		4pcs	4pcs	0pcs	0pcs	0pcs	0pcs
M6*10 Screw		4pcs	4pcs	0pcs	0pcs	0pcs	0pcs
Hose Clamp		2pcs	2pcs	0pcs	0pcs	0pcs	0pcs
Brass Shower Arm		0pcs	0pcs	1pcs	1pcs	1pcs	0pcs
Panel Cotton Bag		1pcs	1pcs	1pcs	1pcs	1pcs	1pcs
Top Spray Cotton Bag		1pcs	1pcs	0pcs	0pcs	0pcs	0pcs
Battery AA1.5V		2pcs	2pcs	2pcs	0pcs	2pcs	0pcs
Stainless Steel Water Outlet Arm		0pcs	0pcs	0pcs	0pcs	0pcs	1pcs
Brass Hex Nut		0pcs	0pcs	0pcs	0pcs	0pcs	1pcs
Water Outlet Adapter		0pcs	0pcs	0pcs	0pcs	0pcs	1pcs
Wall Mounted Spray Booth		0pcs	0pcs	0pcs	0pcs	0pcs	1pcs

ASSEMBLY INSTRUCTIONS

MODEL 6012FL/6002FL/8039FL/8124FL



1 Insert the PVC pipe from the top opening to pierce out.



2 Route the LED light wire along the hole insert into the motherboard.



3 Fix the motherboard and top spray with 4 pairs of M6 screws and nuts.



4 Fix the PVC pipe with a throat clamp on the top spray joint.

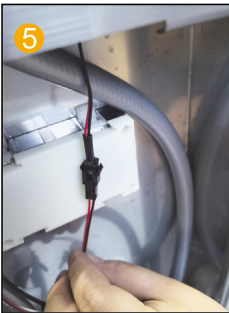

5 Connect the LED light cable and power supply line.

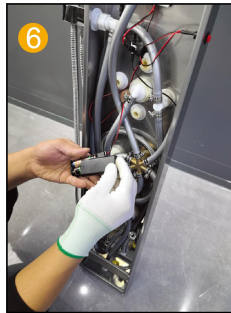

6 Load 2 AA batteries into the battery compartment.

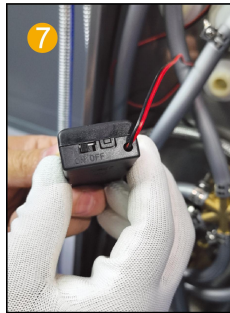

7 Switch the battery box to ON.



8 Insert the hand spray nozzle into the panel And install the gasket.

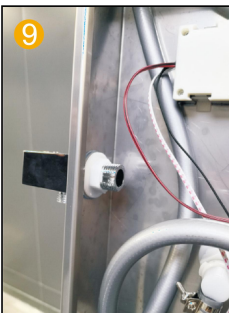

9 Insert the hand spray nozzle into the panel And install the gasket.

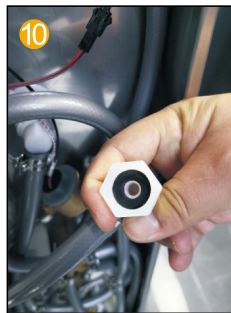

10 Put the 4-point rubber into the hand spray Inside the joint of the seat.

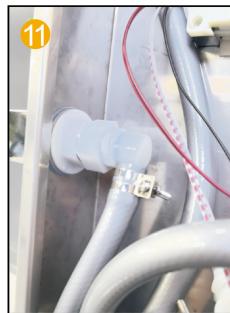

11 Connect the water outlet connector and hand spray seat joint

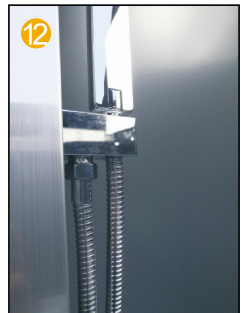

12 Connect the hand spray hose to the handheld one shower head.

MODEL 7009FL/7016FL/7002FL



1 Fix the water outlet arm to the main board.



2 Connect the top spray and the water outlet arm joint.

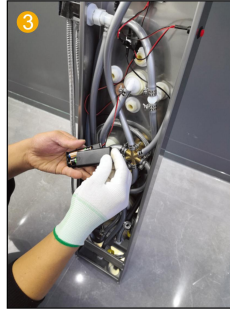

3 Load 2 AA batteries into the battery compartment.

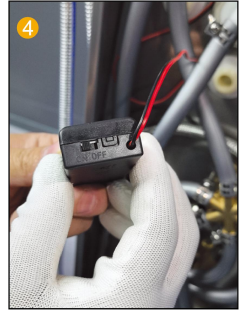

4 Switch the battery box to ON.



5 Insert the hand spray nozzle into the panel and install the gasket.

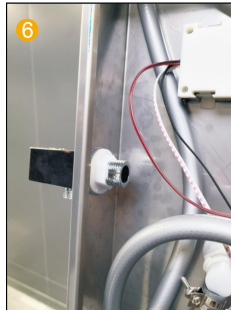

6 Insert the hand spray nozzle into the panel and install the gasket.



7 Put the 4-way rubber into the connector of the hand spray seat.

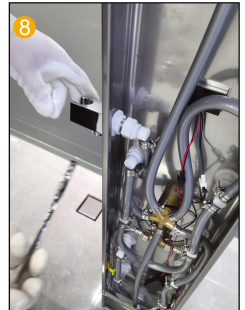

8 Connect the water outlet connector to the hand spray seat connector.

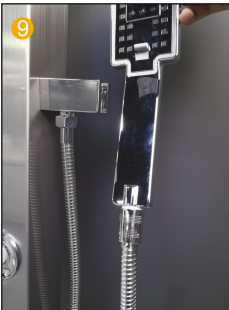

9 Connect the hand-held shower hose and the hand-held shower head.

Note:7016FL no step 3 and 4.

MODEL 7015FY



1 Fix the water outlet arm to the main board with nuts and washers.

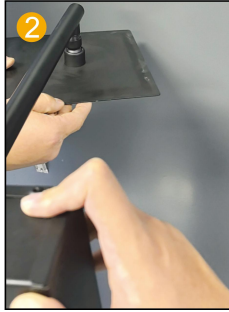

2 Connect the top spray and the water outlet arm joint.



3 Connect the steel wire pipe and the shower arm and tighten it.

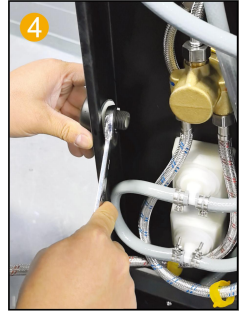

4 Fix the shower outlet connector to the panel with a nut.



5 Put the 4-way rubber into the shower head connector.

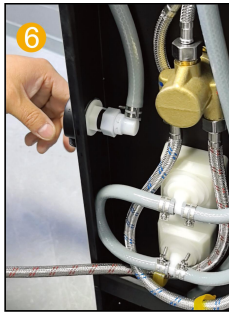

6 Connect the water outlet connector and the shower head water outlet connector.



7 Fix the shower head bracket to the wall at the appropriate position with screws and nuts.



8 Installation of the shower head bracket completed.

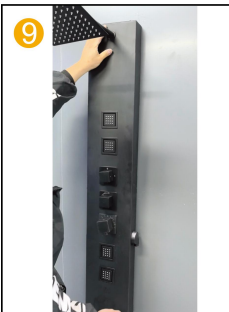

9 Fix the panel to the wall at the appropriate height with the bracket.



10 Connect the handheld shower head to the hose.



11 Connect to the handheld shower head.



12 Installation completed.

INSTALLATION STEPS (GENERAL)

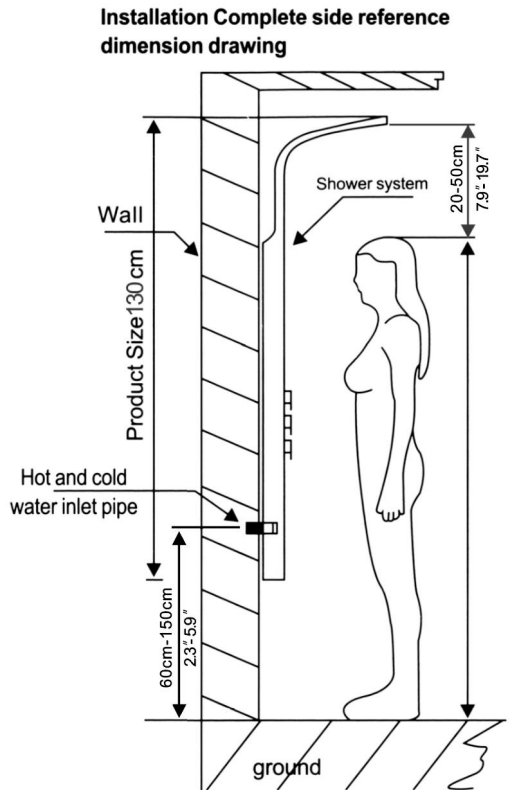
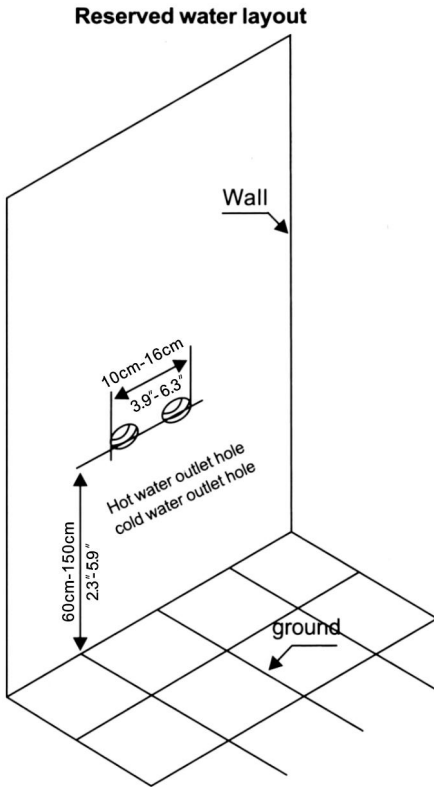

Installation Notes

1. According to the height of the family height budget shower system installation height, measure the shower system on the back of the bar Distance, mark on the wall, in the corresponding position of the tag fixed hanging iron (up and down each one).
2. Connect the hot and cold water hose (be sure to clean the magazine and the dirt in the wall Scale so as not to block, affect the water effect).
3. Shower system hanging on the wall, the upper and lower two cards were clamped in two hanging pastes (Note: shower After the system wall, the main body close to the wall is not shaking, do not need to use another glass glue and other tools fixed).

Stainless steel shower system maintenance methods:

1. Regular cleaning of the product in order to keep its appearance bright and clean;
2. Clean the surface with water or a mild detergent and wipe it with a soft towel.
3. Note that the clean product of the hidden position, timely cleaning can make products lasting.

SHOWER PANEL SERIES INSTALLATION DIAGRAM

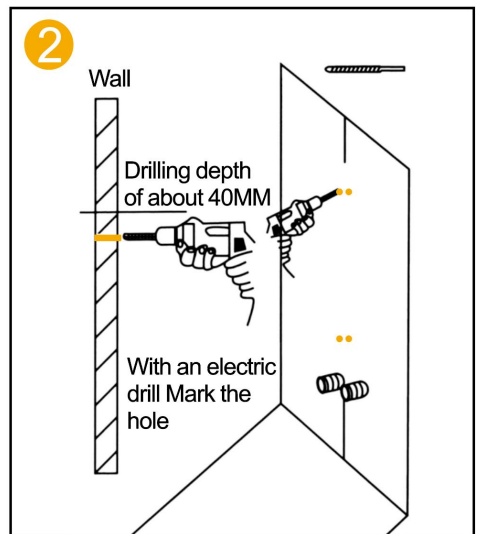
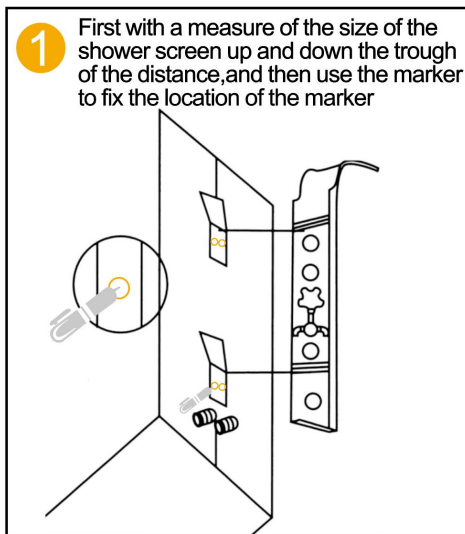

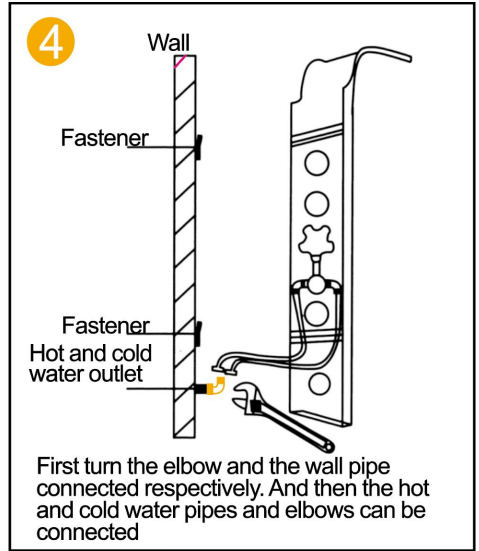
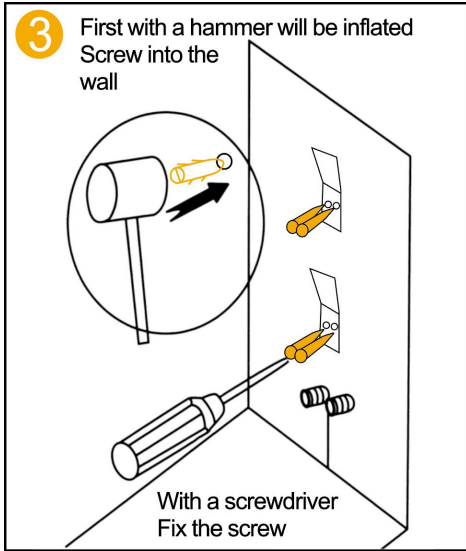

FUNCTION INTRODUCTION

6002FL / 6012FL



FUNCTION INTRODUCTION

8039FL

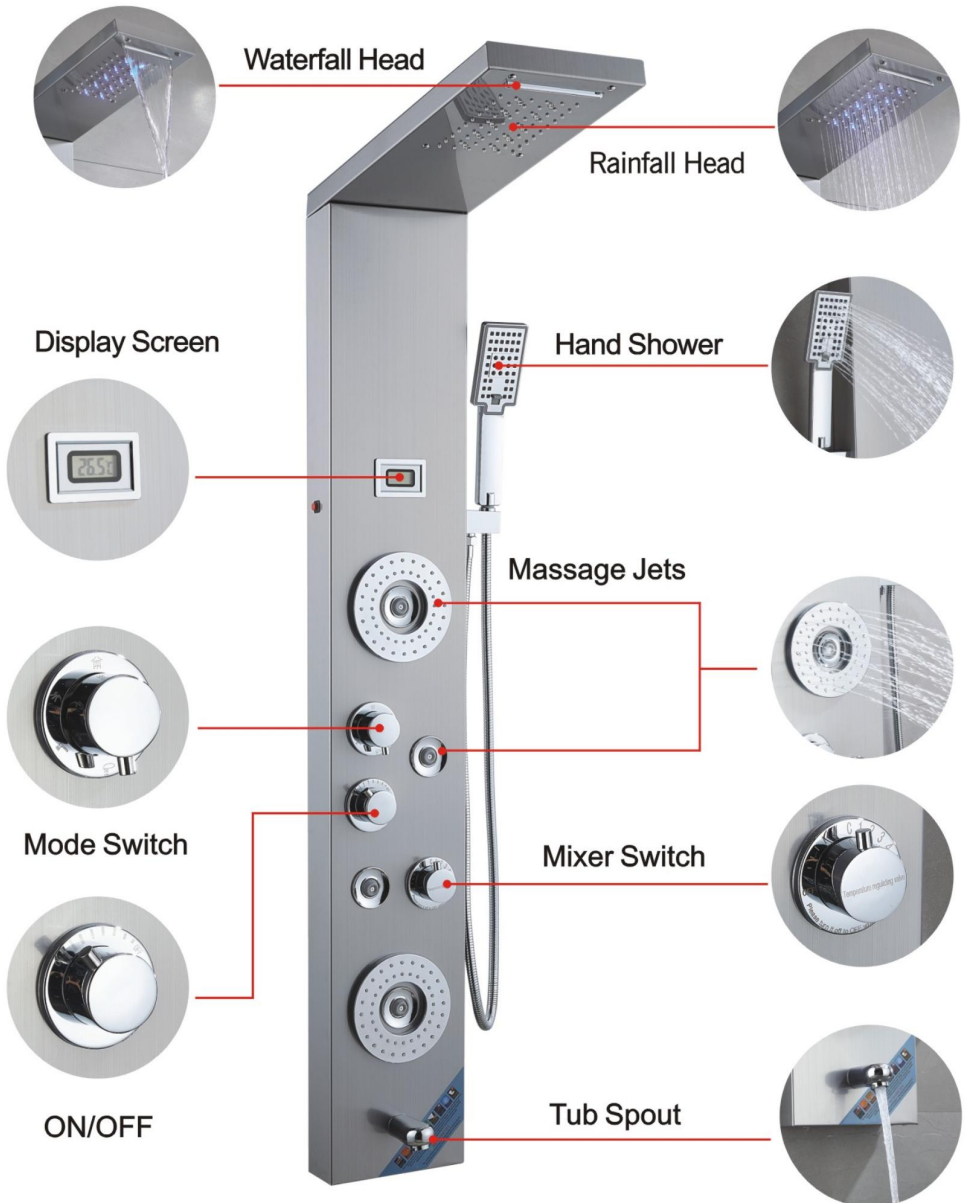

FUNCTION INTRODUCTION

7009FL

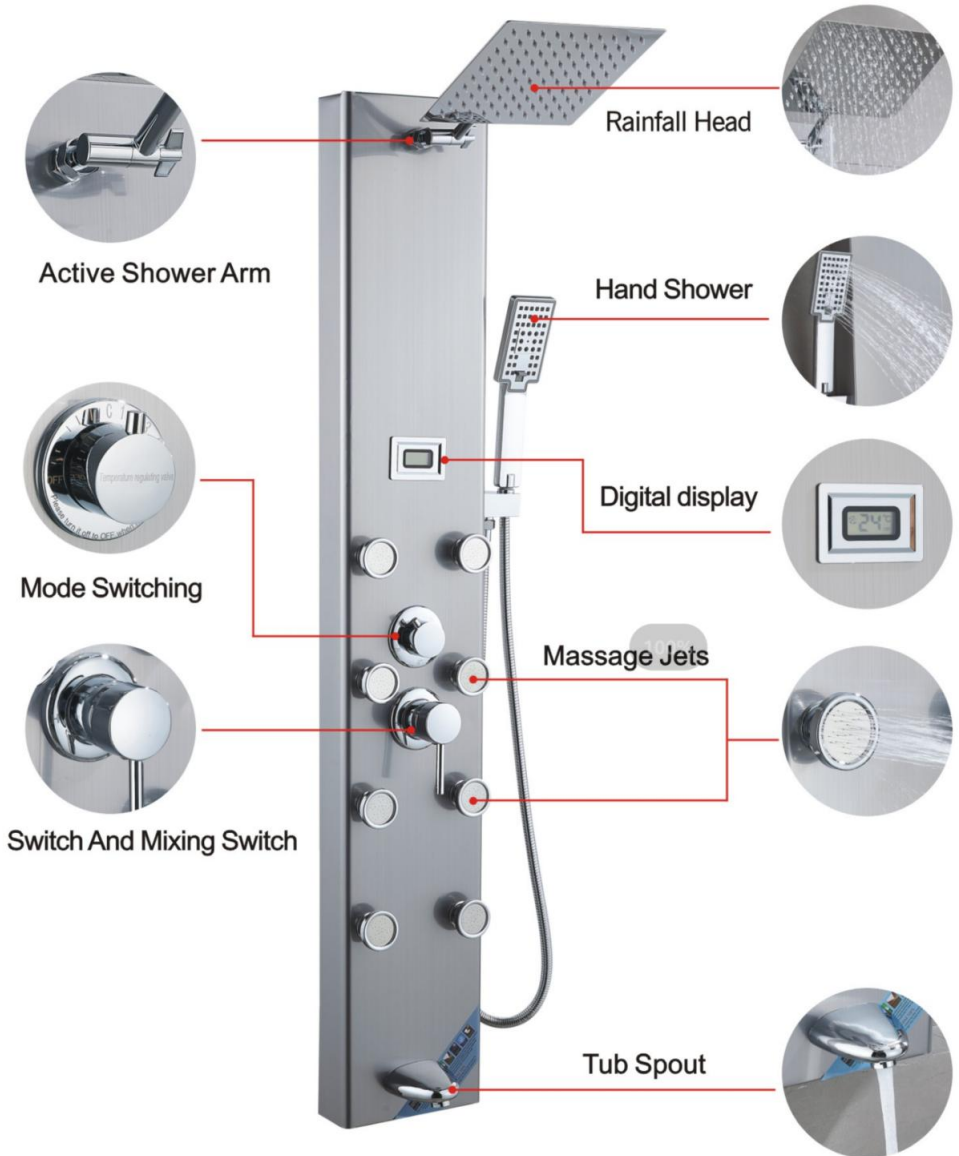

FUNCTION INTRODUCTION

8124FL

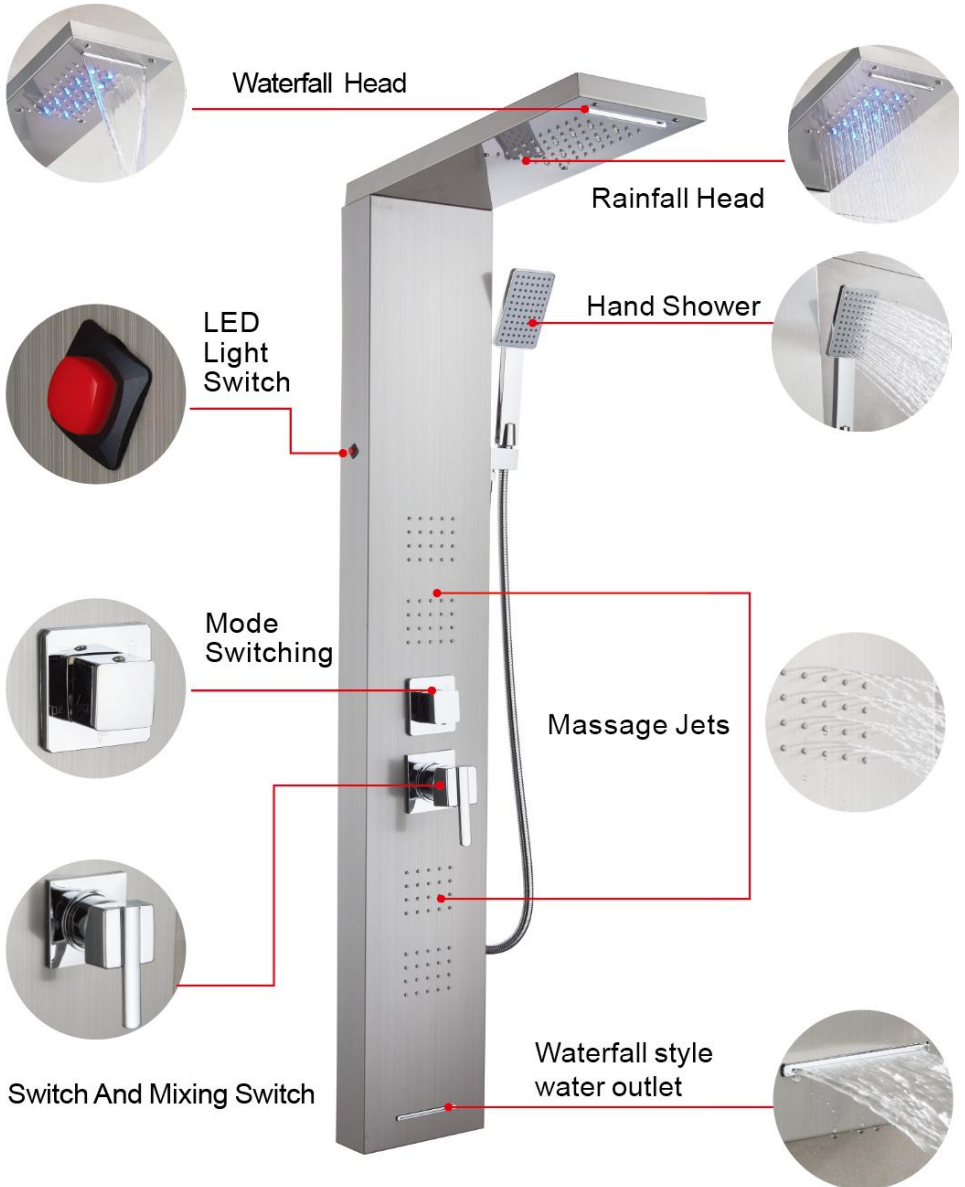

FUNCTION INTRODUCTION

7016FL

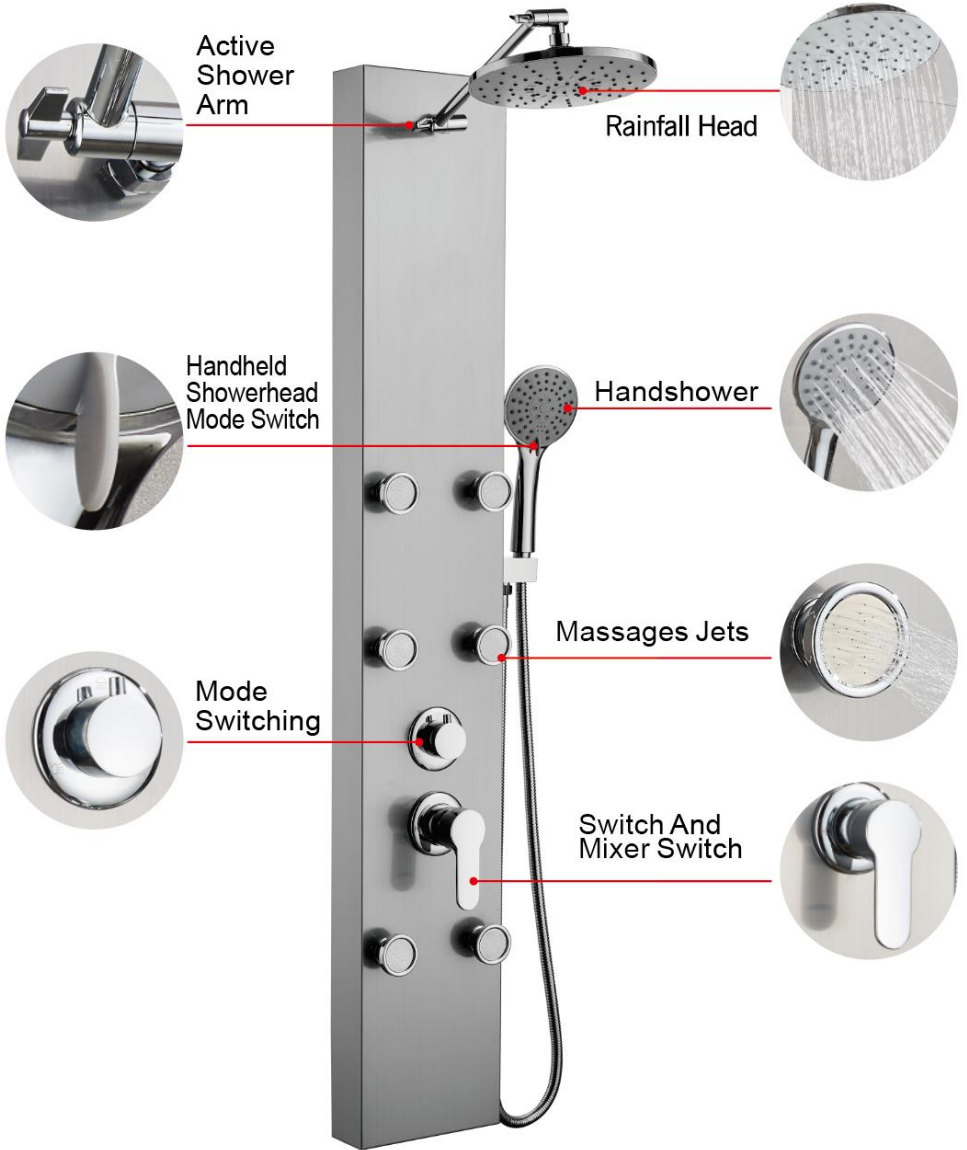

FUNCTION INTRODUCTION

7002FL

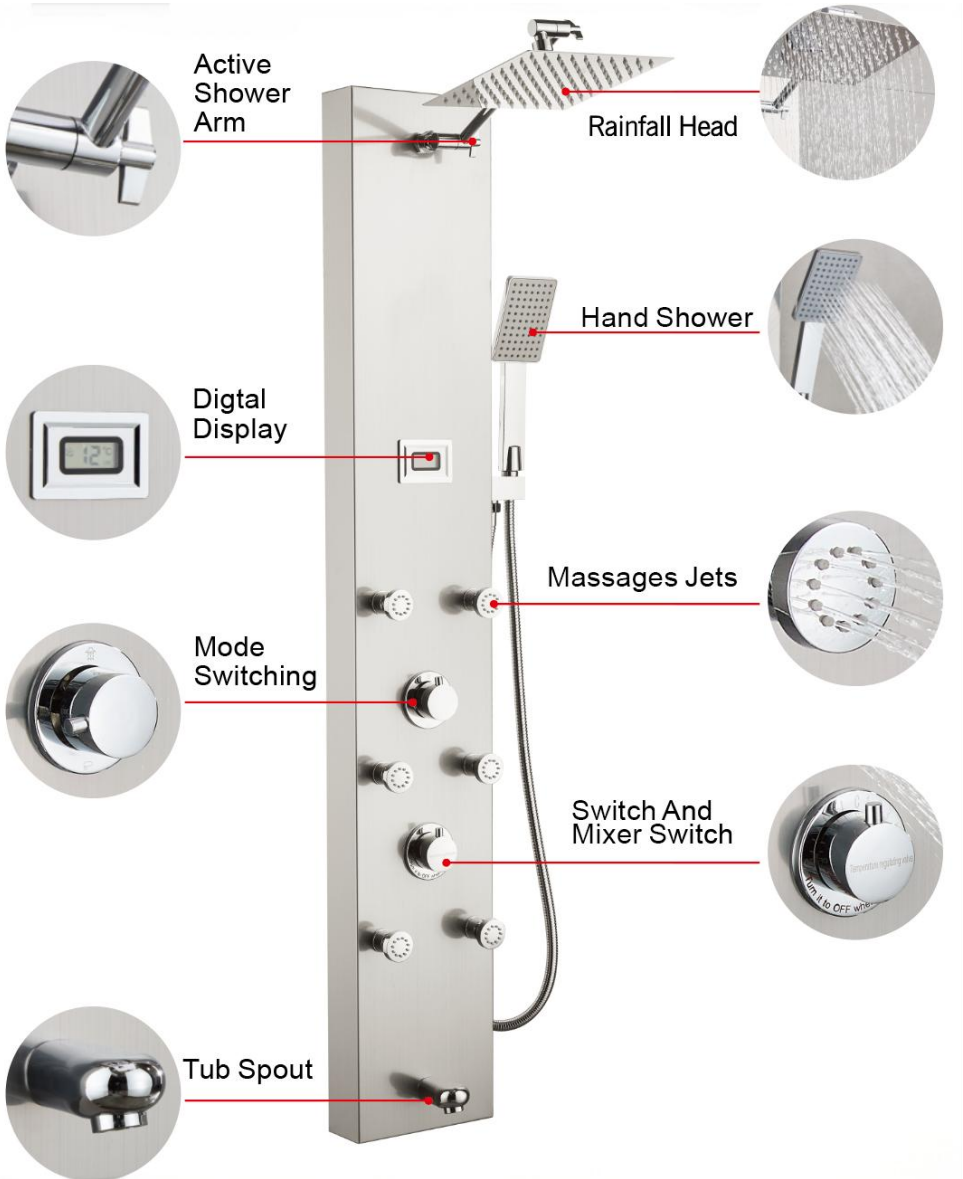

FUNCTION INTRODUCTION

7015FY



Note: For the detailed installation video, please refer to the corresponding model and scan the QR code below to view.

6002FL / 6012FL



8039FL



8124FL



7009FL



7016FL



7002FL



7015FY



Technical Support and E-Warranty Certificate
www.vevor.com/support

VEVOR

Affordable. Reliable. Home Improvement.

PANNEAU DE DOUCHE TOUR

MODÈLE:

6002FL, 8039FL, 7009FL, 6012FL, 8124FL, 7016FL, 7002FL, 7015FY

Assistance technique et certificat de garantie

électronique www.vevor.com/support

VEVOR

Affordable. Reliable. Home Improvement.

PANNEAU DE DOUCHE TOUR





6002FL

6012FL

8039FL 8124FL 7009FL 7016FL 7002FL 7015FY

Il s'agit de la notice d'utilisation d'origine. Veuillez lire attentivement toutes les instructions du manuel avant de l'utiliser. VEVOR se réserve le droit d'interpréter clairement notre manuel d'utilisation. L'apparence du produit dépend du produit que vous avez reçu. Veuillez nous excuser, nous ne vous informerons plus si des mises à jour technologiques ou logicielles sont disponibles sur notre produit.

	<p>Avertissement - Pour réduire le risque de blessure, l'utilisateur doit lire Lisez attentivement le manuel d'instructions.</p>
	<p>Cet appareil est conforme à la partie 15 des règles de la FCC. Son fonctionnement est sous réserve des deux conditions suivantes : (1) Cet appareil ne doit pas provoquer interférences nuisibles, et (2) cet appareil doit accepter toute interférence reçus, y compris les interférences pouvant entraîner un fonctionnement indésirable.</p>
	<p>Ce produit est soumis aux dispositions de la directive européenne 2012/19/CE. Le symbole représentant une poubelle à roulettes barrée indique que le produit nécessite une collecte séparée des déchets dans le Union européenne. Ceci s'applique au produit et à tous les accessoires marqués de ce symbole. Les produits marqués comme tels ne peuvent pas être jeté avec les ordures ménagères normales, mais doit être apporté dans un point de collecte pour le recyclage des appareils électriques et électroniques</p>

INSTRUCTIONS

Conseils d'avertissement :

1. Pendant le processus d'installation, il est préférable de porter des gants pour éviter les objets tranchants. coins du panneau pour éviter de rayer la paume de la main.
2. Lors de l'installation de la douche, assurez-vous que tous les joints sont entièrement serré pour éviter les fuites d'eau.
3. Assurez-vous que les tuyaux d'arrivée d'eau rouge et bleu à l'intérieur du panneau sont dans un endroit non état plié pour éviter d'affecter la pression de l'eau.
4. Lorsque la douche n'est pas utilisée, veuillez fermer la vanne de commutation de la douche.













CONSERVEZ CES INSTRUCTIONS

INSTRUCTIONS D'INSTALLATION

INSTRUCTIONS D'INSTALLATION								
Modèle	6002FL 8039FL 6012FL 8124FL 7009FL 7016FL 7002FL 7015FY							
Montage Taper	Support mural							
Connexion Fil	G1/2"							
Fonctions	Quatre Modes	Six Modes	Cinq Modes	Cinq Modes	Cinq Modes	Trois Modes	Quatre Modes	Quatre Modes
Bec de baignoire	√	√	√	√	√	×	√	√
Température Afficher	×	√	×	×	√	×	√	×
Lampe LED	√	√	√	√	×	×	×	×
Pouvoir	Pile sèche (3VCC)	Pile sèche (3VCC)	Pile sèche (3VCC)	Pile sèche (3VCC)	Pile sèche (3VCC)	×	Pile sèche (3VCC)	×
Main Douche	1-Réglage	3-Réglage	1-Réglage	1-Réglage	3-Réglage	5-Réglage	1-Réglage	1-Réglage
Finition	Système de douche en nickel brossé sans empreintes digitales							Noir- Peinture
Matériel	Acier inoxydable 304 Acier, Laiton, PVC, ABS		Acier inoxydable 201 Acier, Laiton, PVC, ABS		Acier inoxydable 304, laiton, PVC, ABS			

LISTE DES PIÈCES

MODÈLE		8039FL	6002FL 6012FL 8124FL	7009FL 7016FL	7002FL	7015FY	
Portable Douche	 OU 	1 pièce	1 pièce	1 pièce	1 pièce	1 pièce	1 pièce
1,5 mètre Main Pulvérisation Tuyau		1 pièce	1 pièce	1 pièce	1 pièce	1 pièce	1 pièce
Main Siège à jet		1 pièce	1 pièce	1 pièce	1 pièce	1 pièce	0 pièces
1/2 Droite Angle Adaptateur		2 pièces	2 pièces	2 pièces	2 pièces		2 pièces
4 points Caoutchouc		2 pièces	2 pièces	2 pièces	2 pièces		2 pièces
Soi Tapotement Vis	 	4 pièces	4 pièces	4 pièces	4 pièces		4 pièces
Attache		2 pièces	2 pièces	2 pièces	2 pièces		2 pièces
Oeillet		1 pièce	1 pièce	1 pièce	1 pièce	1 pièce	2 pièces
Hexagone Noix		1 pièce	1 pièce	1 pièce	1 pièce	1 pièce	1 pièce

MODÈLE		8039FL	6002FL 6012FL 8124FL	7009FL 7016FL	7002FL	7015FY	
Écrou M6		4 pièces	4 pièces	0 pièces	0 pièces	0 pièces	0 pièces
M6*10 Vis		4 pièces	4 pièces	0 pièces	0 pièces	0 pièces	0 pièces
Collier de serrage		2 pièces	2 pièces	0 pièces	0 pièces	0 pièces	0 pièces
Laiton Bras de douche		0 pièces	0 pièces	1 pièce	1 pièce	1 pièce	0 pièce
Panneau Sac en coton		1 pièce	1 pièce	1 pièce	1 pièce	1 pièce	1 pièce
Spray supérieur Sac en coton		1 pièce	1 pièce	0 pièce	0 pièce	0 pièce	0 pièce
Batterie AA1,5 V		2 pièces	2 pièces	2 pièces	0 pièces	2 pièces	0 pièces
Inoxydable Acier Sortie d'eau Bras		0 pièces	0 pièces	0 pièces	0 pièces	0 pièces	1 pièce
Hex en laiton Noix		0 pièces	0 pièces	0 pièces	0 pièces	0 pièces	1 pièces
Sortie d'eau Adaptateur		0 pièces	0 pièces	0 pièces	0 pièces	0 pièces	1 pièce
Fixation murale Cabine de peinture		0 pièces	0 pièces	0 pièces	0 pièces	0 pièces	1 pièce

INSTRUCTIONS DE MONTAGE

MODÈLE 6012FL/6002FL/8039FL/8124FL



1
Insérez le tuyau en PVC par l'ouverture supérieure pour le percer.



2
Acheminez le fil de la lumière LED le long du trou inséré dans la carte mère.



3
Fixez la carte mère et le spray supérieur avec 4 paires de vis et écrous M6.

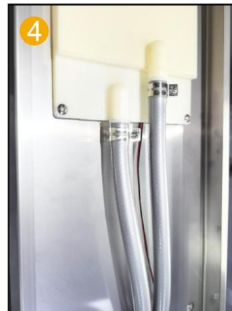

4
Fixez le tuyau en PVC avec un collier de serrage sur le joint de pulvérisation supérieur.

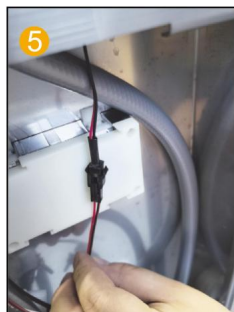

5
Connectez le câble d'éclairage LED et la ligne d'alimentation.

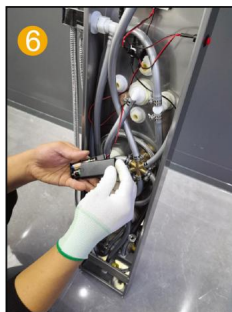

6
Insérez 2 piles AA dans le compartiment à piles.

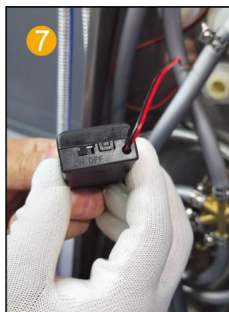

7
Mettez le boîtier de batterie sur ON.



8
Insérez la buse de pulvérisation manuelle dans le panneau et installez le joint.

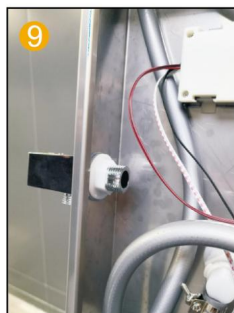

9
Insérez la buse de pulvérisation manuelle dans le panneau et installez le joint.

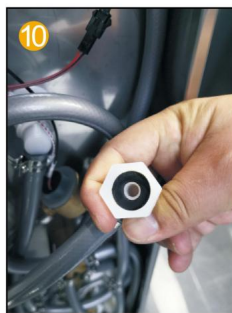

10
Placez le raccord en caoutchouc à 4 points. Connectez l'eau dans le connecteur de sortie du pulvérisateur à main et à l'intérieur du joint du siège du pulvérisateur à main.

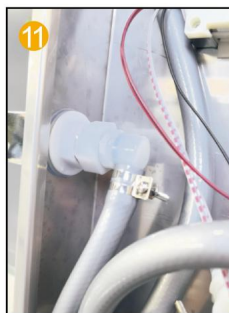

12
Connectez le tuyau du pulvérisateur à main à la pomme de douche à main.

MODÈLE 7009FL/7016FL/7002FL



1 Réparer le bras de sortie d'eau à la carte principale.



2 Connectez le gicleur supérieur et le bras de sortie d'eau

articulation.

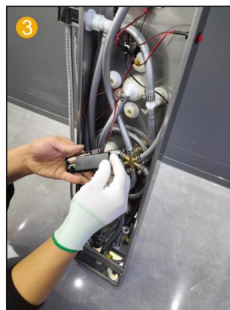

3 Insérez 2 piles AA dans la batterie compartiment.



4 Changer le boîtier de la batterie à ON.



5 Insérez la buse de pulvérisation manuelle dans le panneau et installez le joint.

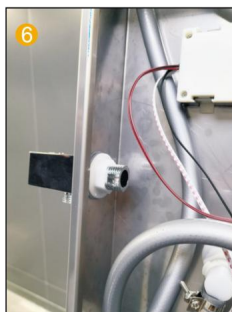

6 Insérez la buse de pulvérisation manuelle dans le panneau et installez le joint.

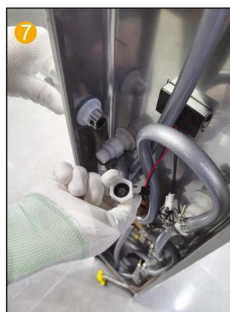

7 Mettre le caoutchouc à 4 voies dans le connecteur du siège avec douche à main.

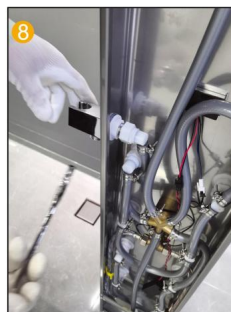

8 Connectez le connecteur de sortie d'eau à la main connecteur de siège de pulvérisation.



9 Connectez l'appareil portatif tuyau de douche et le pommeau de douche à main.

Remarque : 7016FL sans étapes 3 et 4.

MODÈLE 7015FY



1 Réparer le bras de sortie d'eau à la carte principale avec écrous et rondelles.

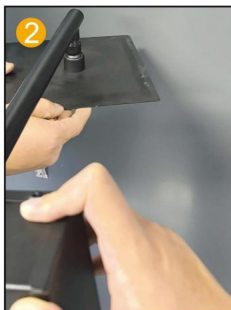

2 Connectez le gicleur supérieur et le bras de sortie d'eau

articulation.



3 Connectez le fil d'acier le tuyau et le bras de douche et serrez-le.

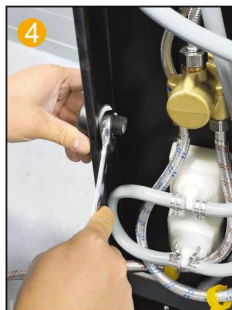

4 Fixez le connecteur de sortie de douche au panneau avec un écrou.

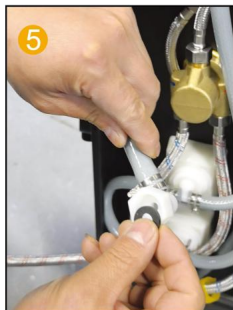

5 Mettre le caoutchouc à 4 voies dans la pomme de douche connecteur.



6 Connectez le connecteur de sortie d'eau et le connecteur de sortie d'eau de pomme de douche.



7 Réparer le pommeau de douche support au mur à la position appropriée avec vis et écrous.

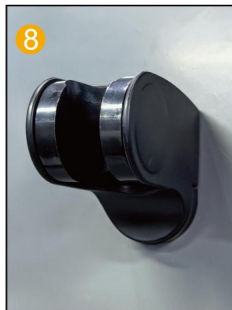

8 Installation du support de pommeau de douche terminée.



9 Fixez le panneau au mur à la hauteur appropriée à l'aide du support.



10 Connectez l'ordinateur de poche pommeau de douche à la tuyau.



11 Connectez-vous au pommeau de douche à main.



12 Installation terminée.

ÉTAPES D'INSTALLATION (GÉNÉRALITÉS)

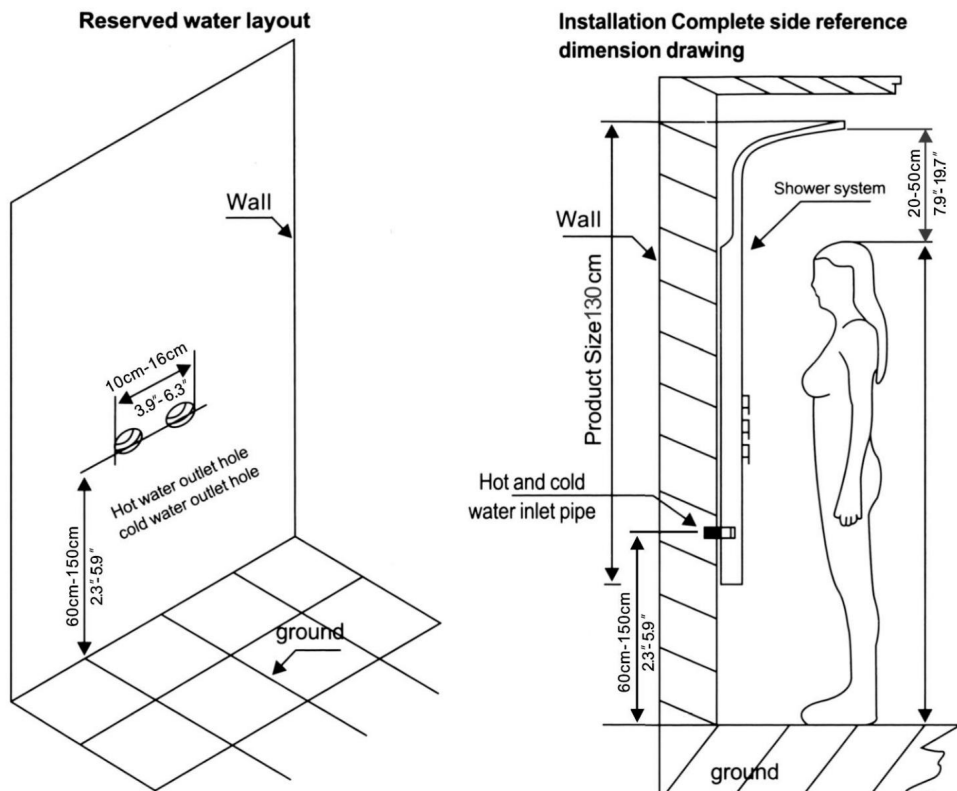

Notes d'installation

1. Selon la hauteur de la hauteur d'installation du système de douche à budget familial, mesurez la distance du système de douche à l'arrière de la barre, marquez sur le mur, dans la position correspondante de l'étiquette fixée au fer suspendu (de haut en bas chacun).
2. Raccordez le tuyau d'eau chaude et froide (assurez-vous de nettoyer le chargeur et la saleté dans le mur Échelle afin de ne pas bloquer, affecter l'effet de l'eau).
3. Système de douche suspendu au mur, les deux cartes supérieure et inférieure ont été serrées dans deux pâtes suspendues (Remarque : douche Après le mur du système, le corps principal près du mur ne tremble pas, n'a pas besoin d'utiliser une autre colle à verre et d'autres outils fixés).

Méthodes d'entretien du système de douche en acier inoxydable :

1. Nettoyage régulier du produit afin de conserver son aspect brillant et

faire le ménage;

2. Nettoyez la surface avec de l'eau ou un détergent doux et essuyez-la avec une serviette douce.

3. Notez que le produit propre de la position cachée, un nettoyage rapide peut faire produits durables.

SCHÉMA D'INSTALLATION DE LA SÉRIE DE PANNEAUX DE DOUCHE

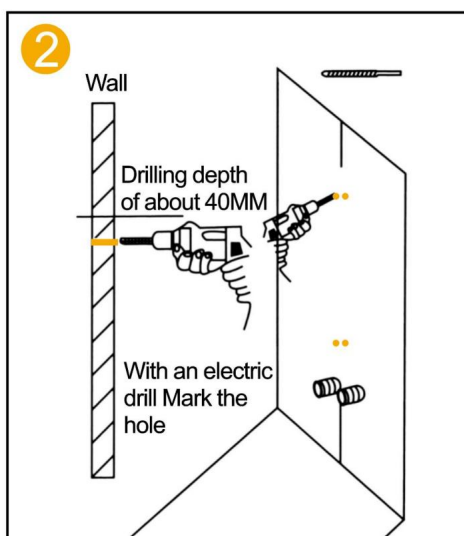
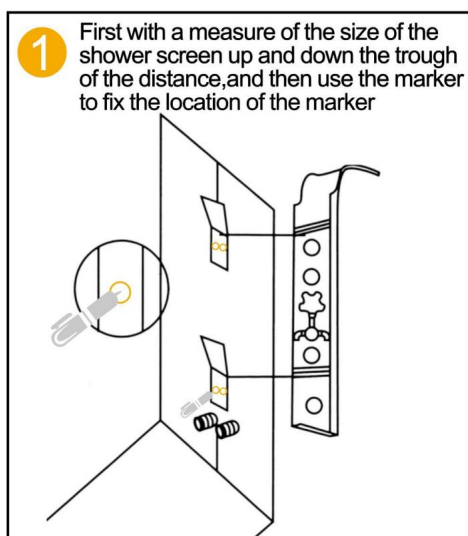

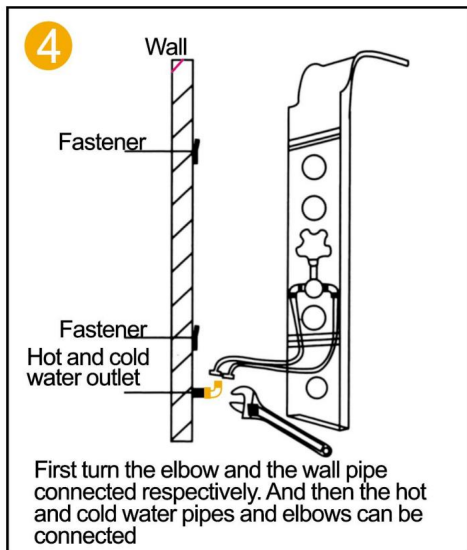
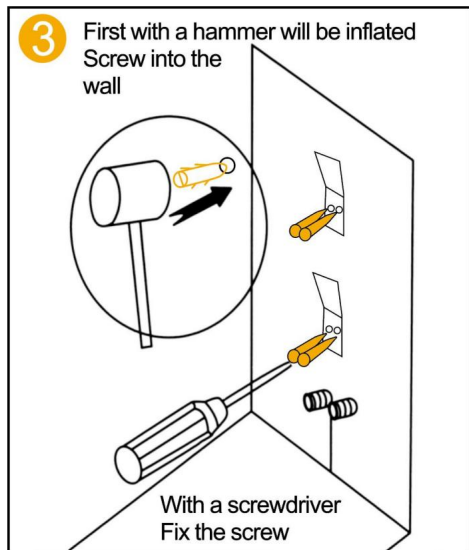

INTRODUCTION AUX FONCTIONS

6002FL / 6012FL



INTRODUCTION AUX FONCTIONS

8039FL

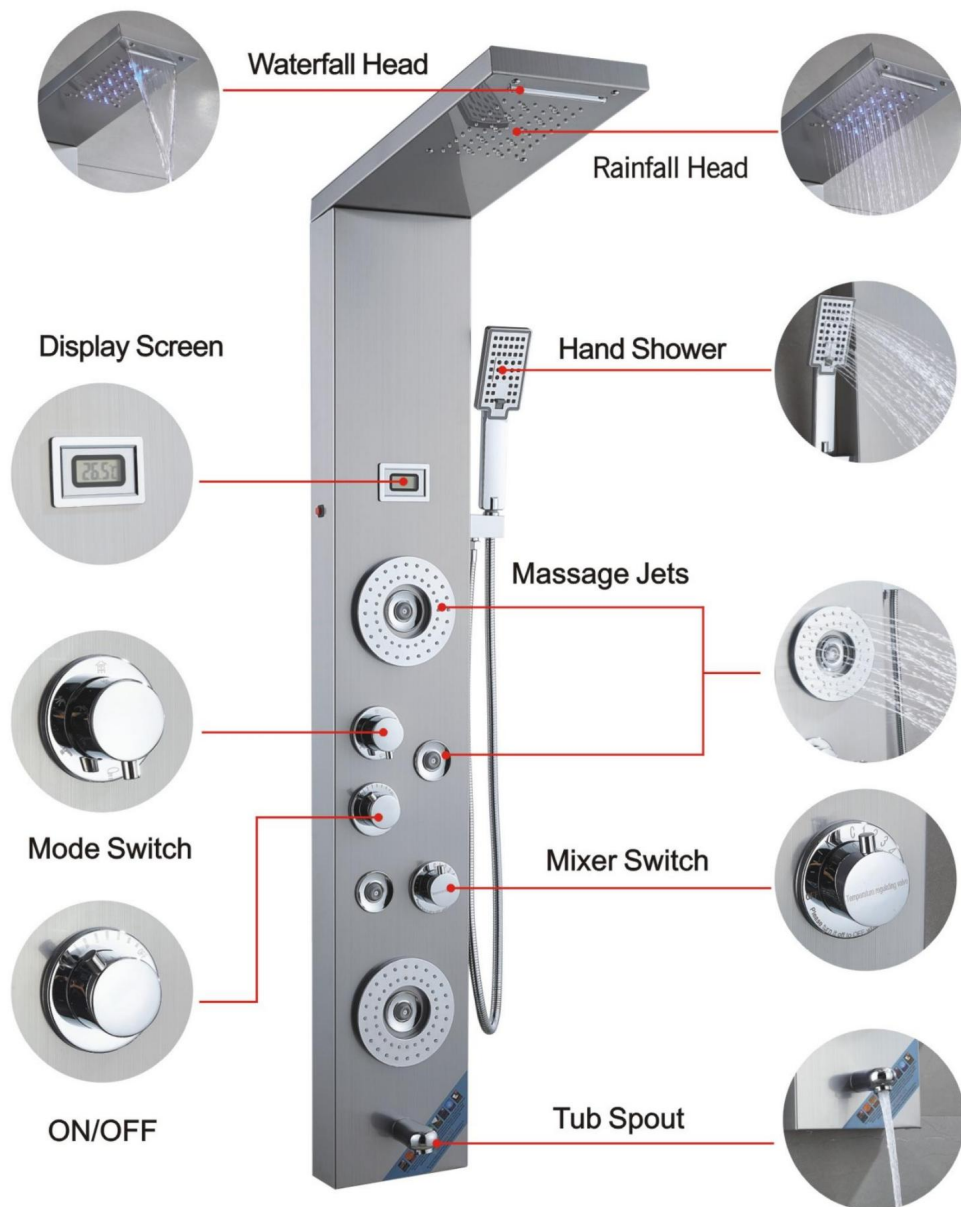

INTRODUCTION AUX FONCTIONS

7009FL

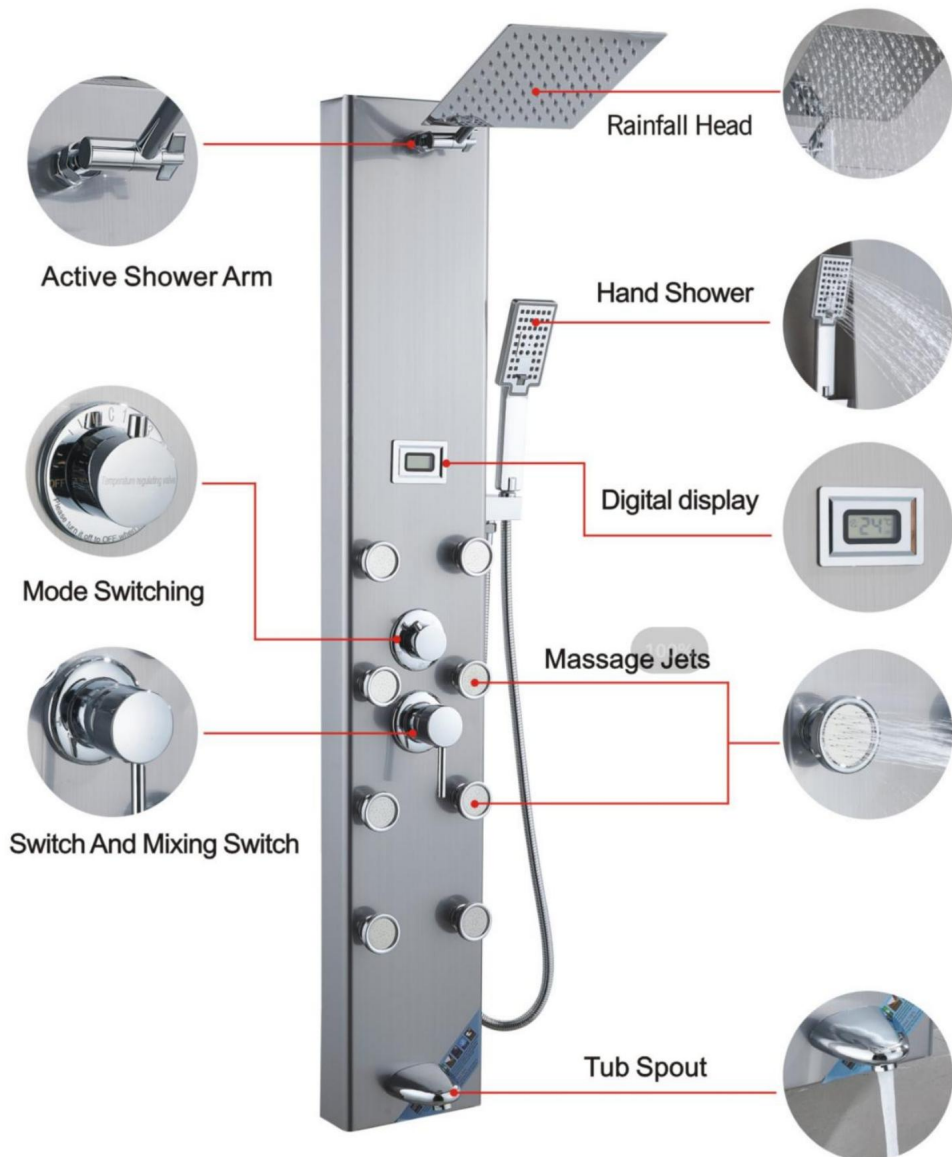

INTRODUCTION AUX FONCTIONS

8124FL



INTRODUCTION AUX FONCTIONS

7016FL

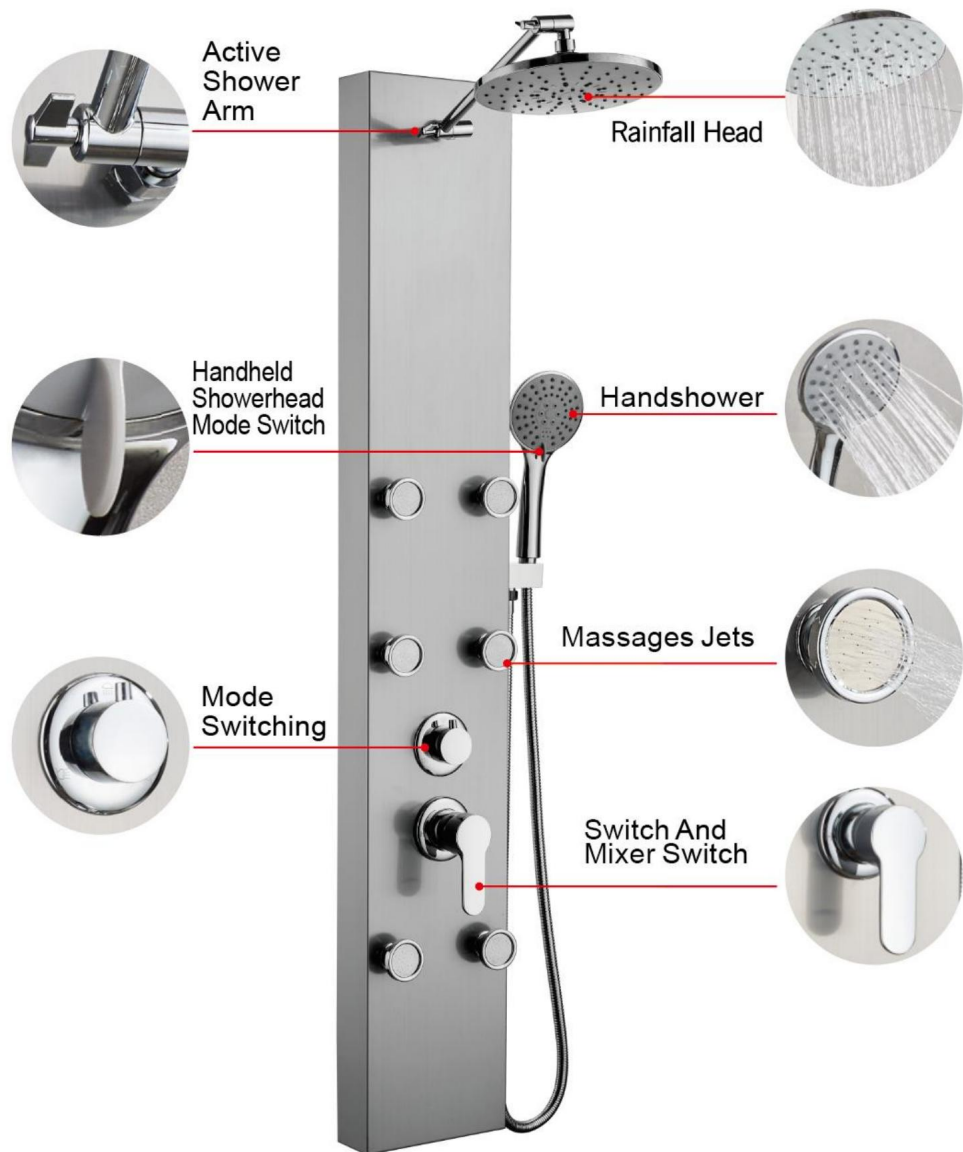

INTRODUCTION AUX FONCTIONS

7002FL

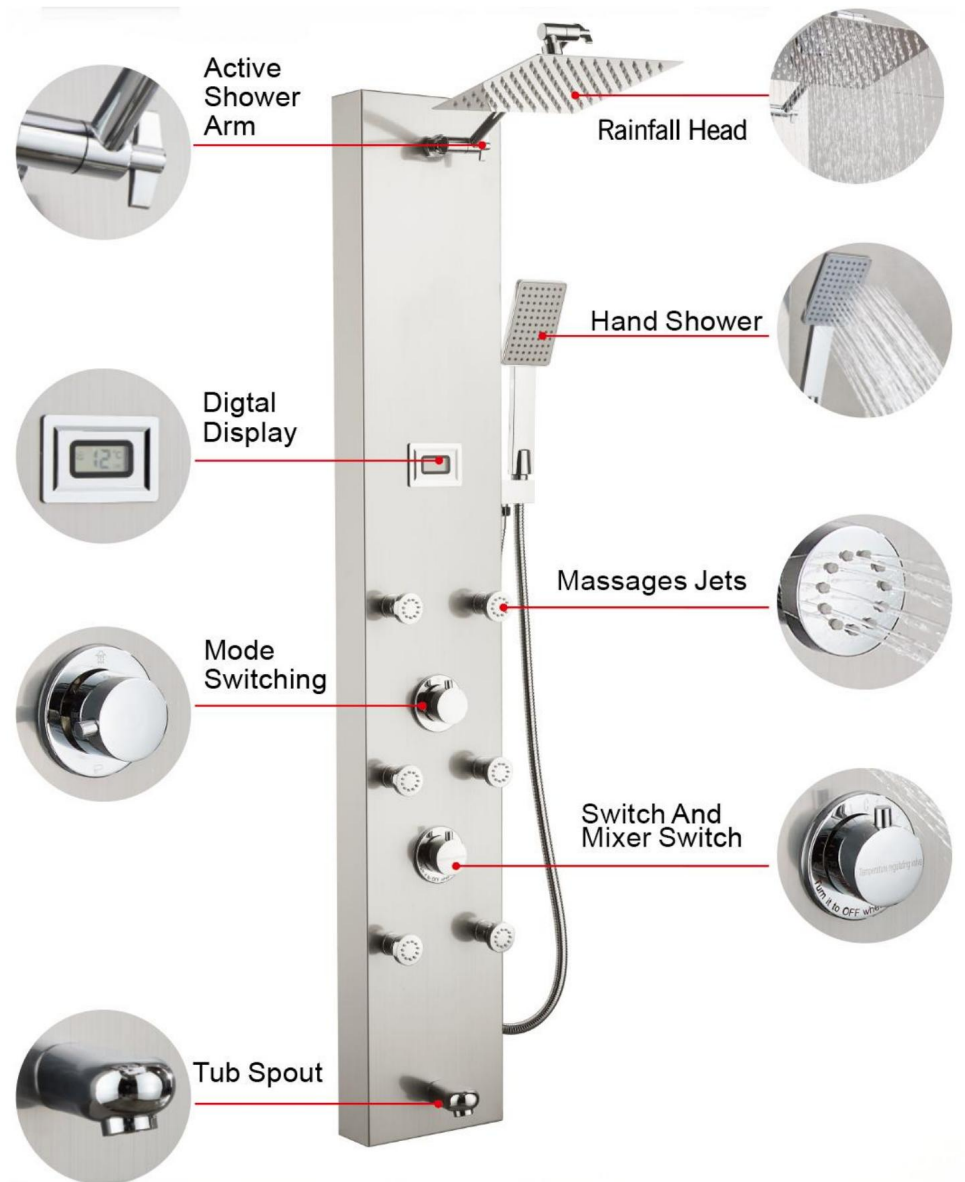

INTRODUCTION AUX FONCTIONS

7015FY

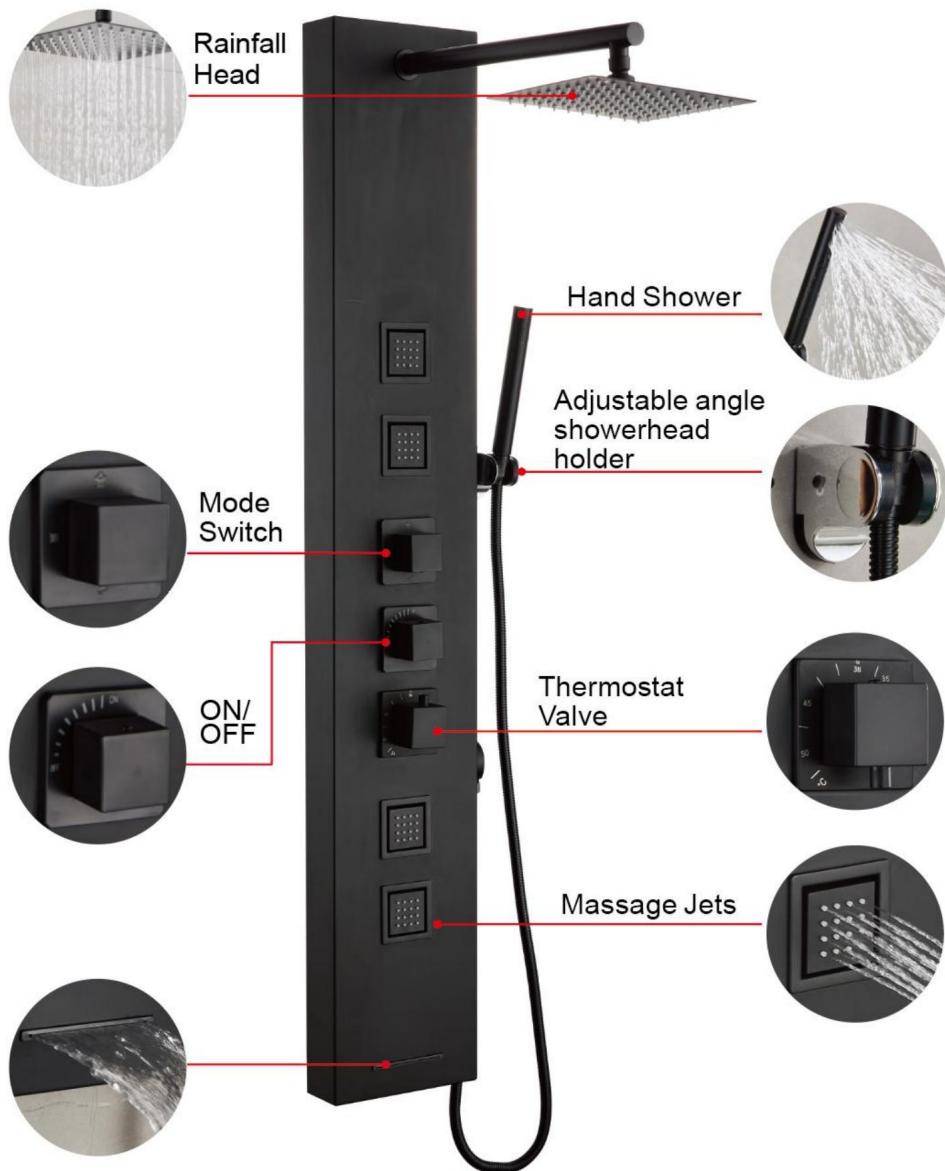

Remarque : pour la vidéo d'installation détaillée, veuillez vous référer à la modèle correspondant et scannez le code QR ci-dessous pour voir.

6002FL / 6012FL



8039FL



8124FL



7009FL



7016FL



7002FL



7015FY



Assistance technique et certificat de garantie électronique

www.vevor.com/support

VEVOR

Affordable. Reliable. Home Improvement.

DUSCHPANEELTURM

MODELL:

6002FL, 8039FL, 7009FL, 6012FL, 8124FL, 7016FL, 7002FL, 7015FY

Technischer Support und E-Garantie-Zertifikat
www.vevor.com/support

VEVOR DUSCHPANEELTUM



Affordable. Reliable. Home Improvement.



6002FL
6012FL

8039FL 8124FL 7009FL 7016FL 7002FL 7015FY

Dies ist die Originalanleitung. Bitte lesen Sie alle Anweisungen sorgfältig durch, bevor Sie das Gerät in Betrieb nehmen. VEVOR behält sich eine klare Auslegung unserer Bedienungsanleitung vor. Das Erscheinungsbild des Produkts richtet sich nach dem Produkt, das Sie erhalten haben. Bitte verzeihen Sie uns, dass wir Sie nicht erneut informieren, wenn es Technologie- oder Software-Updates für unser Produkt gibt.

	<p>Warnung-Um das Verletzungsrisiko zu verringern, muss der Benutzer Lesen Sie die Bedienungsanleitung sorgfältig durch.</p>
	<p>Dieses Gerät entspricht Teil 15 der FCC-Bestimmungen. Der Betrieb ist unter den folgenden beiden Bedingungen:(1) Dieses Gerät darf keine schädliche Interferenzen, und (2) dieses Gerät muss alle Interferenzen akzeptieren empfangen werden, einschließlich Störungen, die einen unerwünschten Betrieb verursachen können.</p>
	<p>Dieses Produkt unterliegt den Bestimmungen der europäischen Richtlinie 2012/19/EG. Das Symbol einer durchgestrichenen Mülltonne weist darauf hin, dass das Produkt einer getrennten Müllentsorgung im Europäische Union. Dies gilt für das Produkt und alle Zubehörteile gekennzeichnet. Produkte, die mit diesem Symbol gekennzeichnet sind, dürfen nicht nicht mit dem normalen Hausmüll entsorgt werden, sondern müssen an einen Sammelstelle für das Recycling von elektrischen und elektronischen Geräten</p>

ANWEISUNGEN

Warnhinweise:

1. Während des Installationsvorgangs ist es am besten, Handschuhe zu tragen, um scharfe Ecken des Panels vor Kratzern in der Handfläche.
2. Bei der Montage der Dusche ist darauf zu achten, dass alle Fugen vollständig festgezogen, um ein Austreten von Wasser zu verhindern.
3. Stellen Sie sicher, dass die roten und blauen Wasserzulaufrohre im Inneren des Panels nicht gefalteten Zustand, um eine Beeinträchtigung des Wasserdrucks zu vermeiden.
4. Wenn die Dusche nicht benutzt wird, schließen Sie bitte das Umschaltventil der Dusche.





















BEWAHREN SIE DIESE ANWEISUNGEN AUF

INSTALLATIONSANLEITUNG

Modell	6002FL 8039	FL 6012	FL 8124	FL 7009	FL 7016	FL 7002	FL 7015	FY
Montage Typ	Wandhalterung							
Verbindung Faden	G1/2"							
Funktionen	Vier Modi	Sechs Modi	Fünf Modi	Fünf Modi	Fünf Modi	Drei Modi	Vier Modi	Vier Modi
Wannenauslauf	ÿ	ÿ	ÿ	ÿ	ÿ	x	ÿ	ÿ
Temperatur Anzeige	x	ÿ	x	x	ÿ	x	ÿ	x
LED-Lampe	ÿ	ÿ	ÿ	ÿ	x	x	x	x
Leistung	Trockenzelle (DC 3 V)	Trockenzelle (DC 3 V)	Trockenzelle (DC 3 V)	Trockenzelle (DC 3 V)	Trockenzelle (DC 3 V)	x	Trockenzelle (DC 3 V)	x
Hand Dusche	1-Einstellung	3-Einstellung	1-Einstellung	1-Einstellung	3-Einstellung	5-Einstellung	1-Einstellung	1-Einstellung
Beenden	Fingerabdruckfreies Duschsystem aus gebürstetem Nickel							Schwarz- Malerei
Material	304 Edelstahl Stahl, Messing, PVC, ABS		201 Edelstahl Stahl, Messing, PVC, ABS		304 Edelstahl, Messing, PVC, ABS			

TEILELISTE

MODELL		8039FL	6002FL 6012FL 8124FL	7009FL 7016FL	7002FL	7015FY	
Handgerät Dusche	 oder 	1 Stück	1 Stück	1 Stück	1 Stück	1 Stück	1 Stück
1.5 Meter Hand Spray Schlauch		1 Stück	1 Stück	1 Stück	1 Stück	1 Stück	1 Stück
Hand Sprühsitz		1 Stück	1 Stück	1 Stück	1 Stück	1 Stück	0 Stück
1/2 Rechts Winkel Adapter		2 Stück	2 Stück	2 Stück	2 Stück		2 Stück
4-Punkt Gummi		2 Stück	2 Stück	2 Stück	2 Stück		2 Stück
Selbst Tippen Schrauben		4 Stück	4 Stück	4 Stück	4 Stück		4 Stück
Verschluss		2 Stück	2 Stück	2 Stück	2 Stück		2 Stück
Tülle		1 Stück	1 Stück	1 Stück	1 Stück	1 Stück	2 Stück
Hexagon Nuss		1 Stück	1 Stück	1 Stück	1 Stück	1 Stück	1 Stück

MODELL		8039FL	6002FL 6012FL 8124FL	7009FL	7016FL	7002FL	7015FY	
M6 Mutter		4 Stück	4 Stück	0 Stück	0 Stück	0 Stück	0 Stück	0 Stück
M6*10 Schrauben		4 Stück	4 Stück	0 Stück	0 Stück	0 Stück	0 Stück	0 Stück
Schlauchschelle		2 Stück	2 Stück	0 Stück	0 Stück	0 Stück	0 Stück	0 Stück
Messing Duscharm		0 Stück	0 Stück	1 Stück		1 Stück	1 Stück	0 Stück
Bedienfeld Baumwolltasche		1 Stück	1 Stück	1 Stück	1 Stück	1 Stück	1 Stück	1 Stück
Top-Spray Baumwolltasche		1 Stück	1 Stück	0 Stück	0 Stück	0 Stück	0 Stück	0 Stück
Batterie AA 1,5 V		2 Stück	2 Stück	2 Stück	0 Stück	2 Stück	0 Stück	0 Stück
Edelstahl Stahl Wasserauslass Arm		0 Stück	0 Stück	0 Stück	0 Stück	0 Stück	0 Stück	1 Stück
Messing Sechskant Nuss		0 Stück	0 Stück	0 Stück	0 Stück	0 Stück	1 Stück	1 Stück
Wasserauslass Adapter		0 Stück	0 Stück	0 Stück	0 Stück	0 Stück	0 Stück	1 Stück
Wandmontage Spritzkabine		0 Stück	0 Stück	0 Stück	0 Stück	0 Stück	0 Stück	1 Stück

MONTAGEANLEITUNG

MODELL 6012FL/6002FL/8039FL/8124FL



1
Führen Sie das PVC-Rohr durch die obere Öffnung ein, um es durchzustechen.



2
Verlegen Sie das LED-Lichtkabel entlang des Lochensatzes in die Hauptplatte.



3
Befestigen Sie die Hauptplatte und das Top-Spray mit 4 Paar M6-Schrauben und Muttern.



4
Befestigen Sie das PVC-Rohr mit einer Halsschelle am oberen Sprühanschluss.

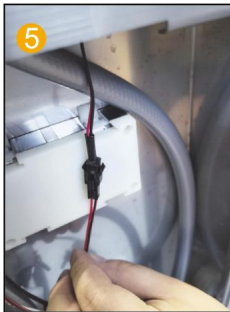

5
Schließen Sie das LED-Lichtkabel und die Stromversorgungsleitung an.

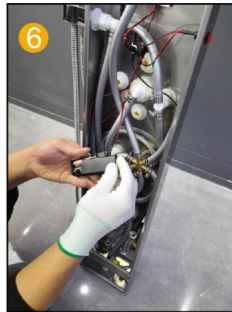

6
Legen Sie 2 AA-Batterien in das Batteriefach ein.



7
Schalten Sie das Batteriefach auf ON.



8
Setzen Sie die Handsprühdüse in die Platte ein und installieren Sie die Dichtung.

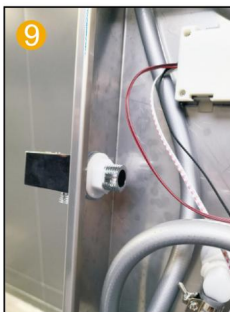

9
Setzen Sie die Handsprühdüse in die Platte ein und installieren Sie die Dichtung.

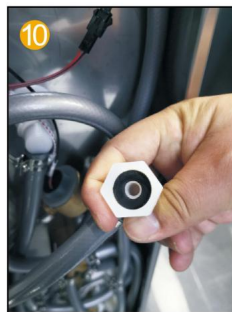

10
Stecken Sie den 4-Punkt-Gummi in den Handbrausen-Auslassanschluss und in die Verbindung des Handbrausen-Sitzes. Schließen Sie das Wasser an.

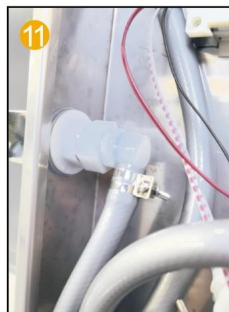

12
Schließen Sie den Handbrausenschlauch an den Handbrausenkopf an.

MODELL 7009FL/7016FL/7002FL



1 Befestigen Sie den Wasserauslassarm zur Hauptplatte.



2 Verbinden Sie die obere Brause und den Wasserauslassarm gemeinsam.

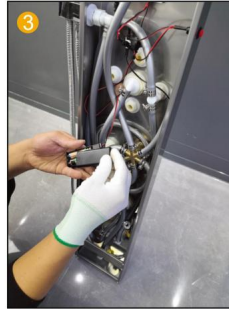

3 Legen Sie 2 AA-Batterien in die Batterie Fach.

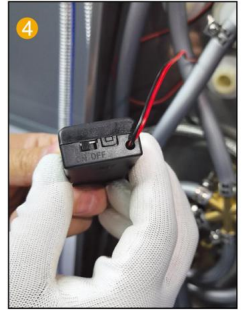

4 Wechseln Sie den Batteriekasten auf EIN.



5 Setzen Sie die Handsprühdüse in die Platte ein und installieren Sie die Dichtung.



6 Setzen Sie die Handsprühdüse in die Platte ein und installieren Sie die Dichtung.



7 Setzen Sie den 4-Wege-Gummi in den Anschluss des Handbrause.

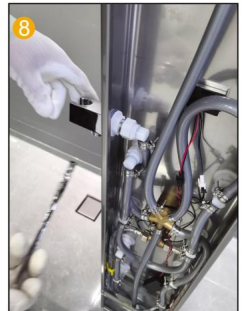

8 Schließen Sie den Wasserauslassanschluss an die Hand Sprühitzanschluss.



9 Verbinden Sie das Handgerät Brauseschlauch und der Handbrause.

Hinweis: 7016FL ohne Schritte 3 und 4.

MODELL 7015FY



1 Befestigen Sie den Wasserauslassarm an die Hauptplatte mit Muttern und Unterlegscheiben.

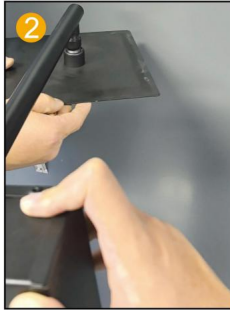

2 Verbinden Sie die obere Brause und den Wasserauslassarm

gemeinsam.



3 Verbinden Sie den Stahlbraht Rohr und Brausearm und ziehen Sie es fest.

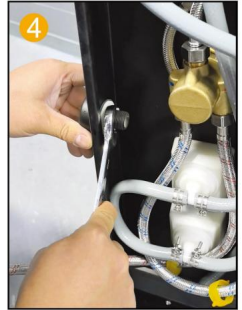

4 Befestigen Sie den Duschabflusssanschluss mit einer Mutter an der Platte.



5 Setzen Sie den 4-Wege-Gummi in den Duschkopf in den Anschluss.



6 Verbinden Sie den Wasserauslassanschluss und die Wasserauslassanschluss des Duschkopfs.



7 Den Duschkopf reparieren Halterung an der Wand an der entsprechende Position mit Schrauben und Muttern.



8 Installation der Duschkopfhalterung fertiggestellt.



9 Befestigen Sie das Panel mit der Halterung in der entsprechenden Höhe an der Wand.



10 Verbinden Sie das Handheld Duschkopf zum Schlauch.



11 Verbinden Sie sich mit dem Handbrause.



12 Installation abgeschlossen.

INSTALLATIONSSCHRITTE (ALLGEMEIN)

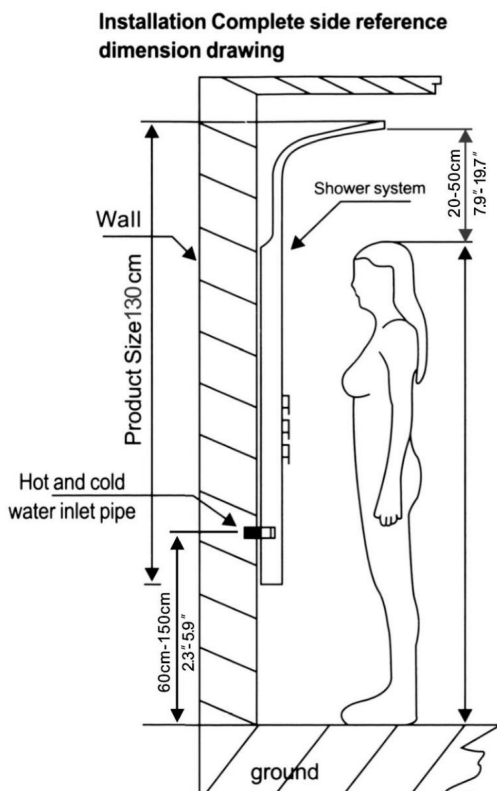
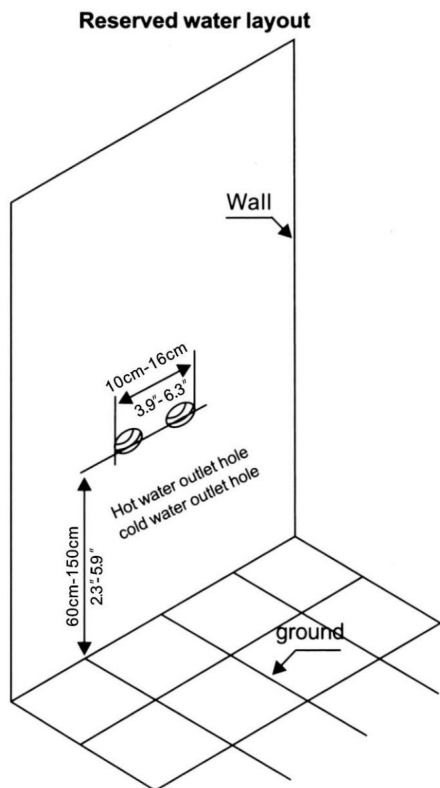

Installationshinweise

1. Messen Sie entsprechend der Installationshöhe des Familien-Budget-Duschsystems den Abstand an der Rückseite der Duschstange, markieren Sie ihn an der Wand und befestigen Sie die Aufhängevorrichtung an der entsprechenden Stelle (jeweils oben und unten).
2. Schließen Sie den Warm- und Kaltwasserschlauch an (achten Sie darauf, das Magazin zu reinigen und den Schmutz in der Wandablagerung zu entfernen, damit es nicht zu Verstopfungen kommt und die Wasserwirkung beeinträchtigt wird).
3. Das Duschsystem wird an die Wand gehängt. Die oberen und unteren beiden Karten werden mit zwei Aufhängestiften festgeklemt. (Hinweis: Nachdem das Duschsystem an die Wand gehängt wurde, wackelt der Hauptkörper nicht mehr dicht an der Wand. Es ist nicht nötig, einen weiteren Glaskleber oder andere Werkzeuge zur Befestigung zu verwenden.)

Wartungsmethoden für Edelstahldusysteme:

1. Regelmäßige Reinigung des Produkts, um sein Aussehen hell und sauber;
2. Reinigen Sie die Oberfläche mit Wasser oder einem milden Reinigungsmittel und wischen Sie sie mit einem weichen Tuch ab.
3. Beachten Sie, dass das saubere Produkt der versteckten Position, rechtzeitige Reinigung kann machen Produkte von Dauer.

DUSCHPANEEL-SERIE - INSTALLATIONS DIAGRAMM

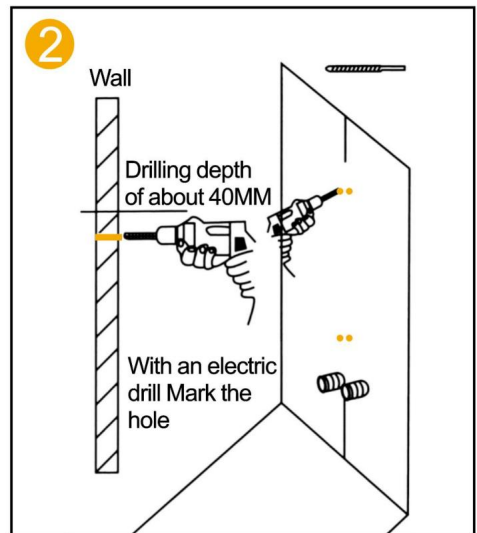
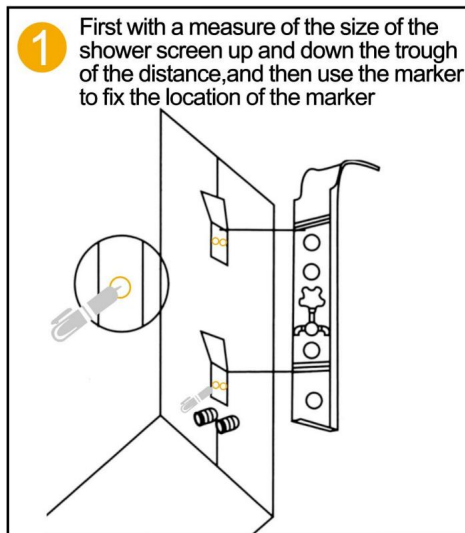

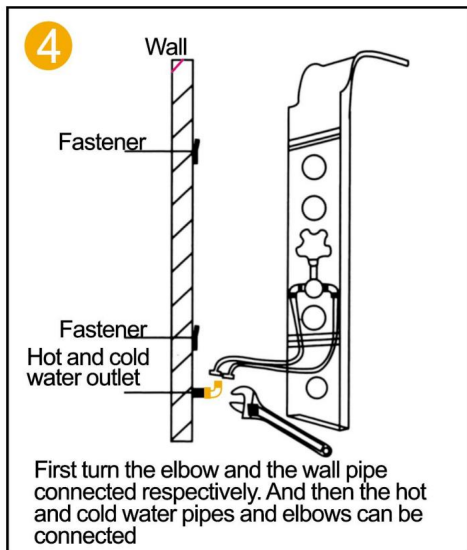
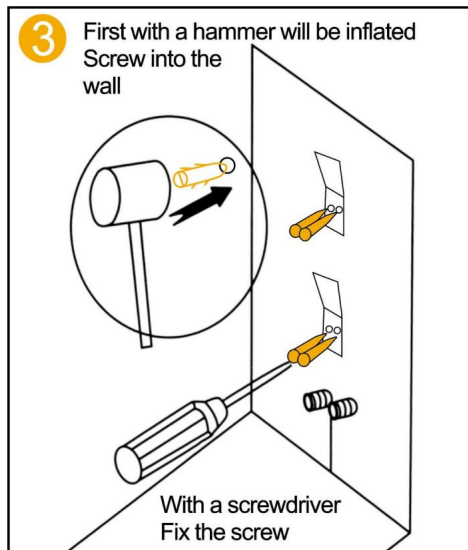

FUNKTION EINFÜHRUNG

6002FL / 6012FL



FUNKTION EINFÜHRUNG

8039FL

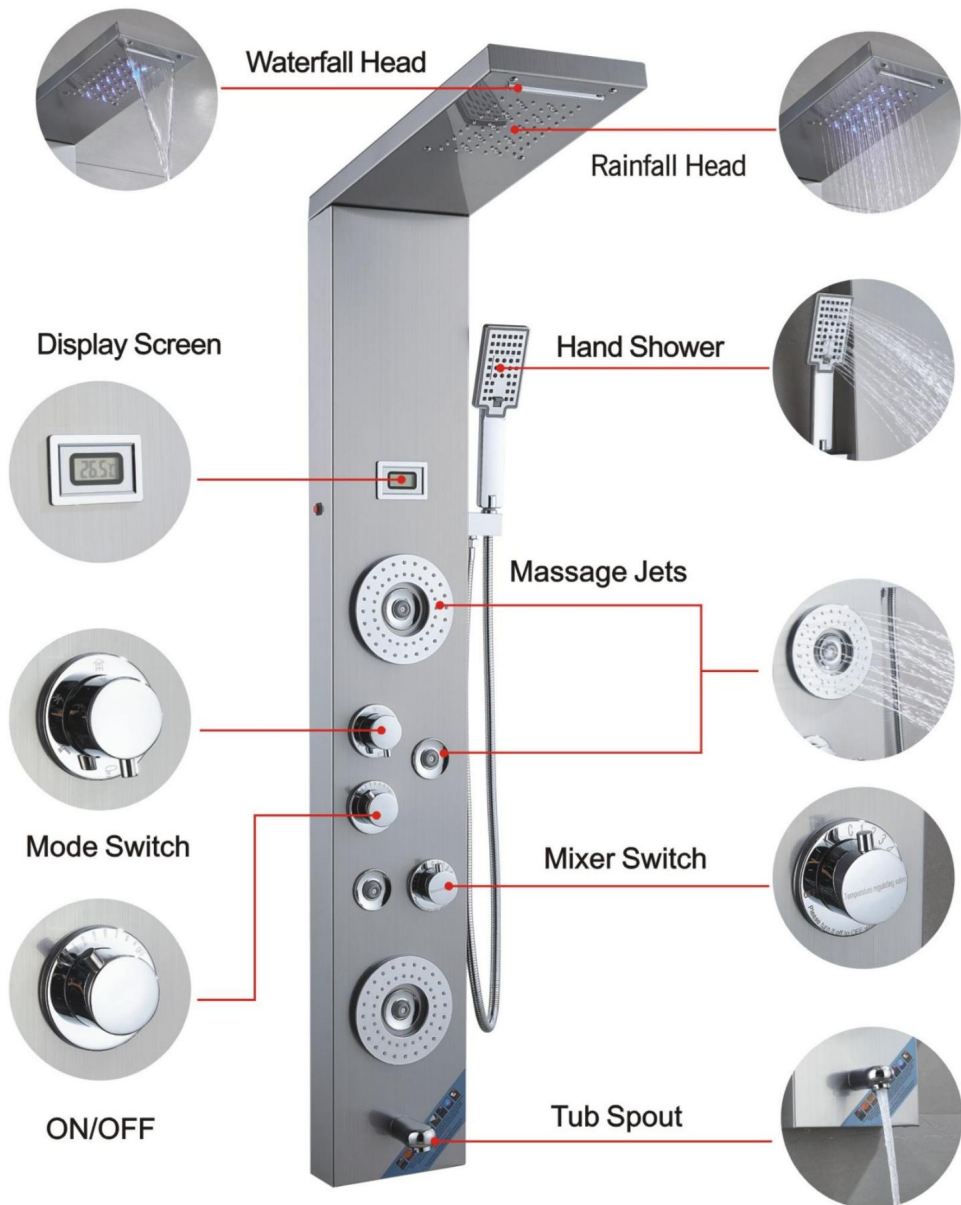

FUNKTION EINFÜHRUNG

7009FL

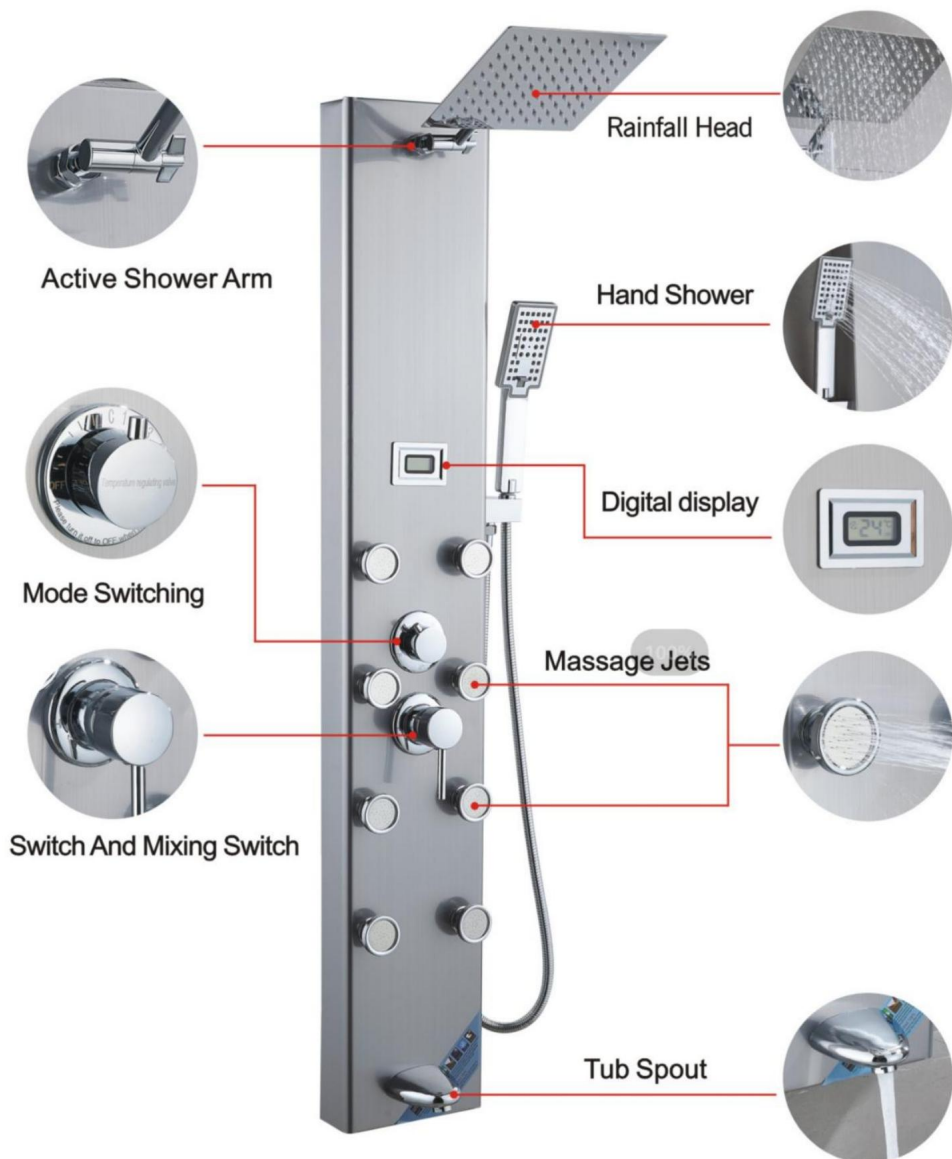

FUNKTION EINFÜHRUNG

8124FL



FUNKTION EINFÜHRUNG

7016FL

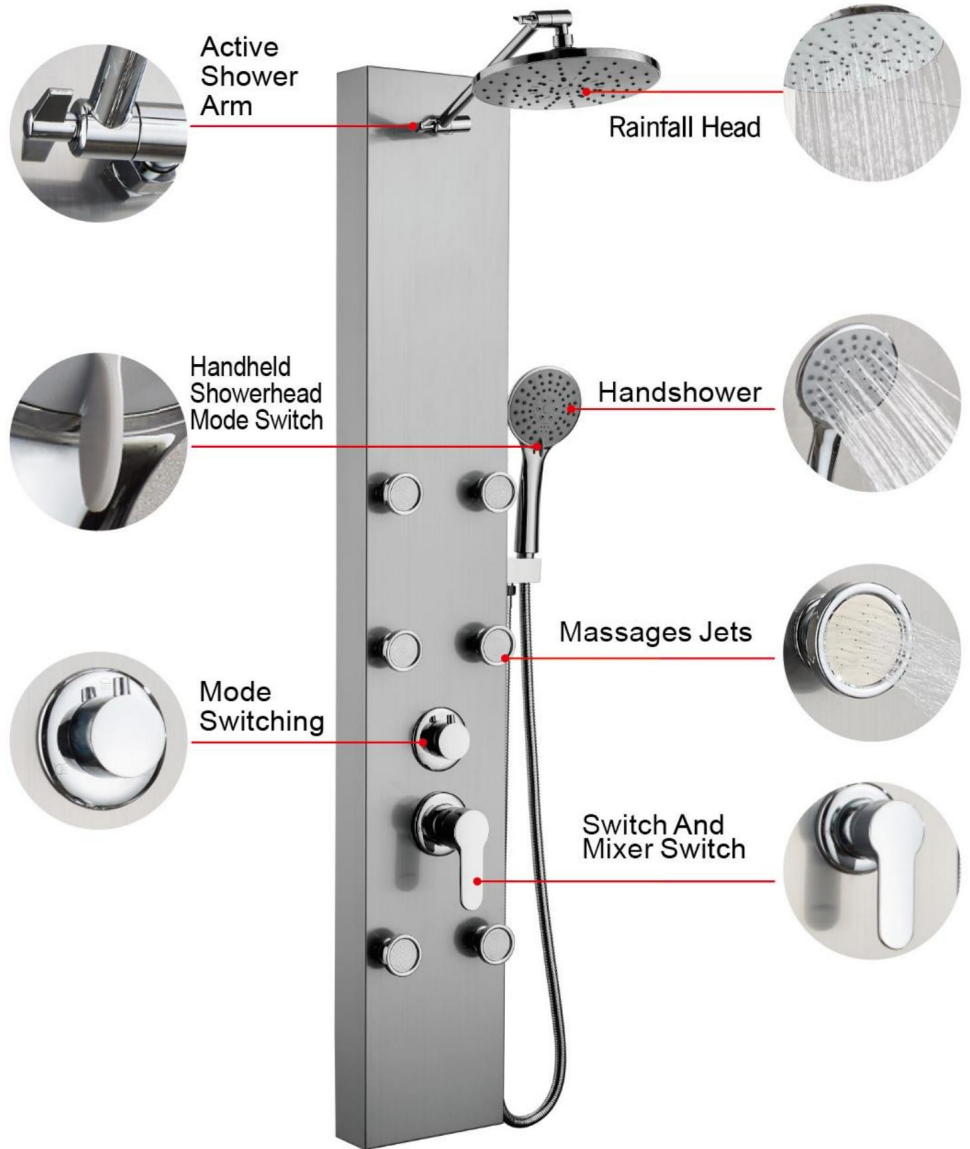

FUNKTION EINFÜHRUNG

7002FL

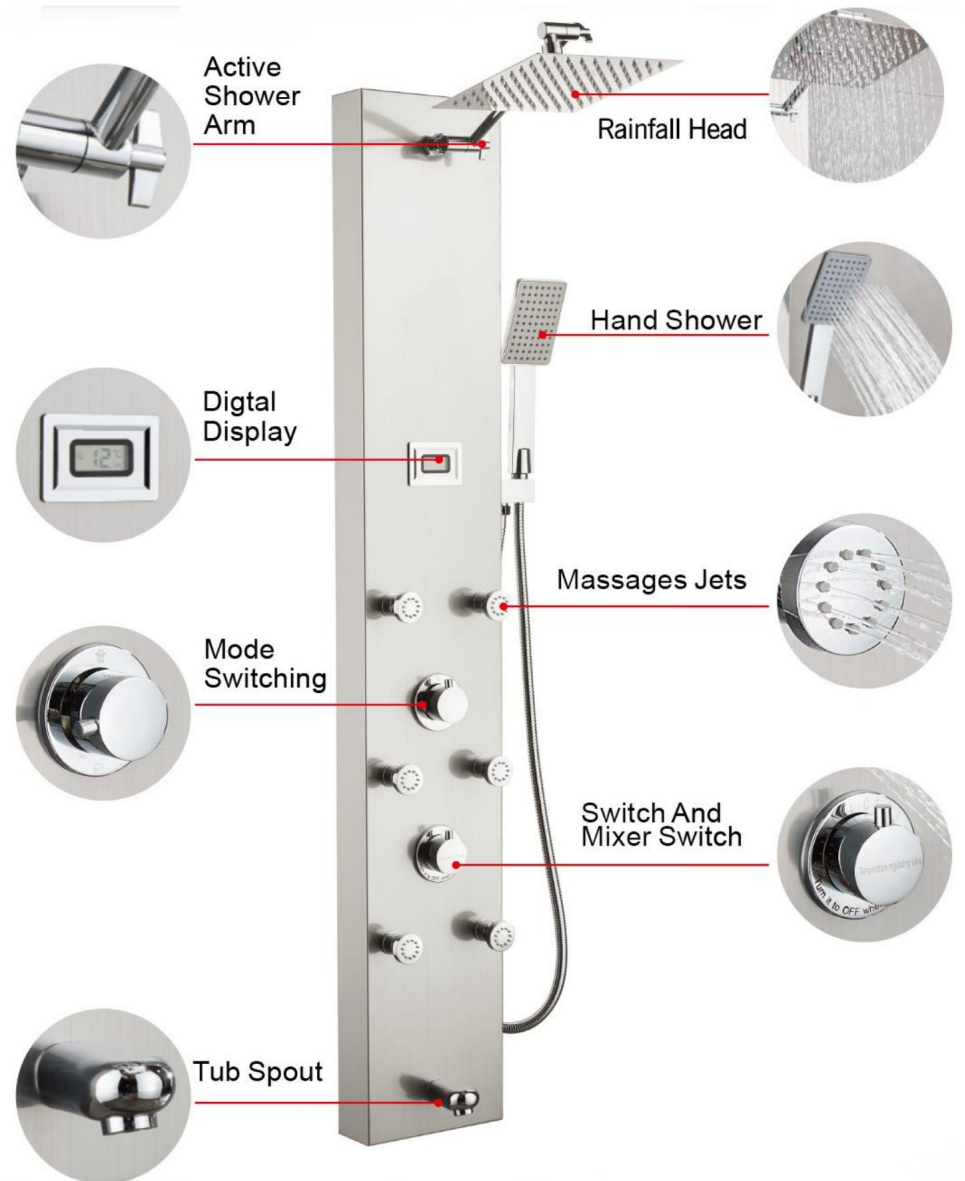

FUNKTION EINFÜHRUNG

7015FY

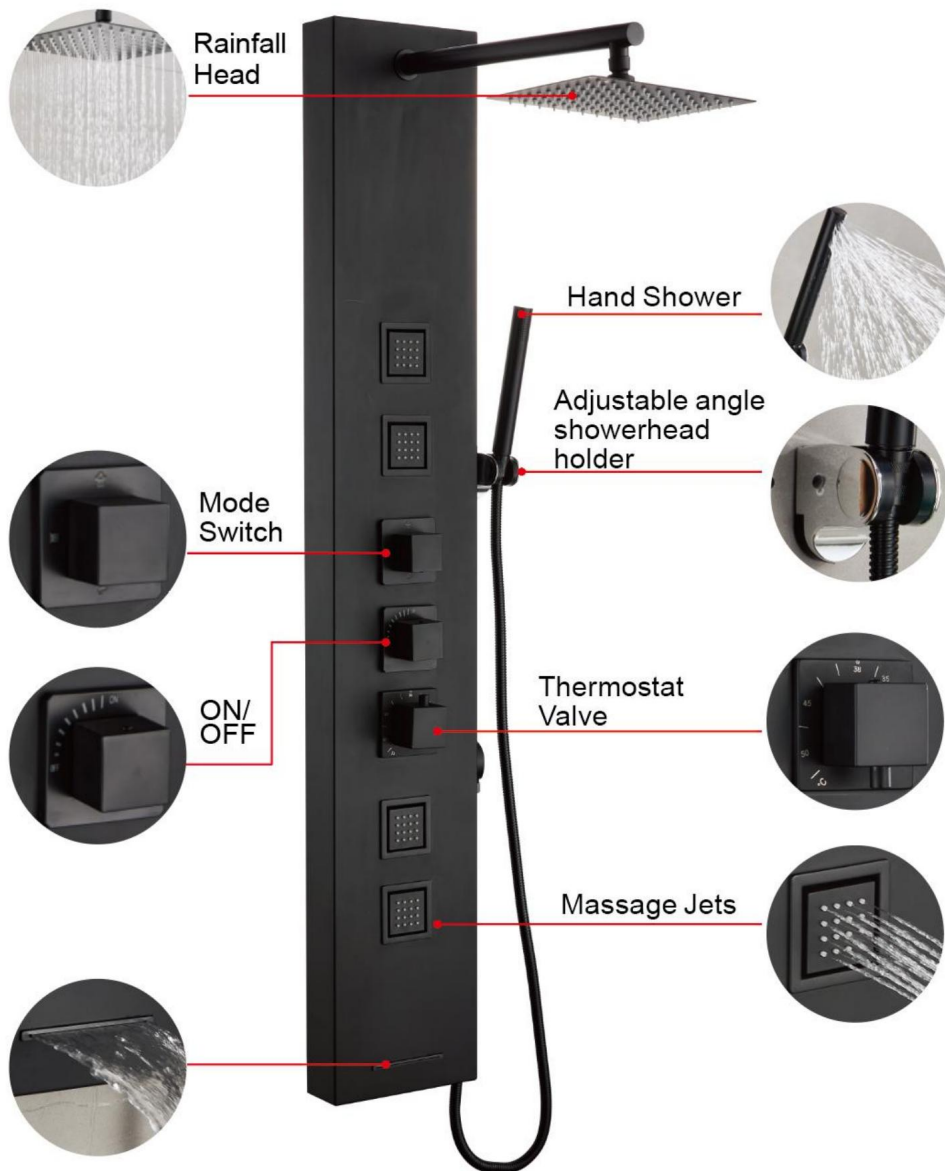

Hinweis: Das ausführliche Installationsvideo finden Sie im entsprechenden Modell und scannen Sie den QR-Code unten, um es anzuzeigen.

6002FL / 6012FL



8039FL



8124FL



7009FL



7016FL



7002FL



7015FY



Technischer Support und E-Garantie-Zertifikat
www.vevor.com/support

VEVOR

Affordable. Reliable. Home Improvement.

TORRE PANNELLO DOCCIA

MODELLO:

6002FLÿ8039FLÿ7009FLÿ6012FLÿ8124FLÿ7016FLÿ7002FLÿ7015FY

Supporto tecnico e certificato di garanzia

elettronica www.vevor.com/support

VEVOR

TORRE PANNELLO DOCCIA

Affordable. Reliable. Home Improvement.





6002FL

6012FL

Italiano:

Questa è l'istruzione originale, si prega di leggere attentamente tutte le istruzioni del manuale prima di utilizzare. VEVOR si riserva una chiara interpretazione del nostro manuale utente. L'aspetto del prodotto sarà soggetto al prodotto ricevuto. Vi preghiamo di perdonarci se non vi informeremo di nuovo se ci sono aggiornamenti tecnologici o software sul nostro prodotto.

	<p>Attenzione: per ridurre il rischio di lesioni, l'utente deve leggere attentamente il manuale di istruzioni.</p>
	<p>Questo dispositivo è conforme alla Parte 15 delle Norme FCC. Il funzionamento è soggetto alle due condizioni seguenti: (1) Questo dispositivo non può causare interferenze dannose e (2) questo dispositivo deve accettare qualsiasi interferenza ricevuti, comprese le interferenze che potrebbero causare un funzionamento indesiderato.</p>
	<p>Questo prodotto è soggetto alle disposizioni della Direttiva Europea 2012/19/CE. Il simbolo raffigurante un bidone della spazzatura barrato indica che il prodotto richiede una raccolta differenziata dei rifiuti Unione Europea. Ciò si applica al prodotto e a tutti gli accessori contrassegnati con questo simbolo. I prodotti contrassegnati come tali non possono essere smaltiti insieme ai normali rifiuti domestici, ma deve essere portato in un punto di raccolta per il riciclaggio di apparecchiature elettriche ed elettroniche</p>

ISTRUZIONI

Suggerimenti di avvertimento:

1. Durante il processo di installazione, è meglio indossare guanti per evitare tagli affilati angoli del pannello per evitare di graffiare il palmo della mano.
2. Quando si installa la doccia, assicurarsi che tutti i giunti siano completamente serrati per evitare perdite d'acqua.
3. Assicurarsi che i tubi di ingresso dell'acqua rosso e blu all'interno del pannello siano in una posizione non stato piegato per non influire sulla pressione dell'acqua.
4. Quando la doccia non è in uso, chiudere la valvola di commutazione della doccia.























SALVA QUESTE ISTRUZIONI

ISTRUZIONI PER L'INSTALLAZIONE

Modello	Italiano:							
Montaggio Tipo	Montaggio a parete							
Connessione Filo	G1/2"							
Funzioni	Quattro Modalità	Sei Modalità	Cinque Modalità	Cinque Modalità	Cinque Modalità	Tre Modalità	Quattro Modalità	Quattro Modalità
Beccuccio per vasca	ÿ	ÿ	ÿ	ÿ	ÿ	x	ÿ	ÿ
Temperatura Display	x	ÿ	x	x	ÿ	x	ÿ	x
Lampada a LED	ÿ	ÿ	ÿ	ÿ	x	x	x	x
Energia	Pila a secco (CC3V)	Pila a secco (CC3V)	Pila a secco (CC3V)	Pila a secco (CC3V)	Pila a secco (CC3V)	x	Pila a secco (CC3V)	x
Mano Doccia	1-Impostazione	3-Impostazione	1-Impostazione	1-Impostazione	3-Impostazione	5-Impostazione	1-Impostazione	1-Impostazione
Fine	Sistema doccia in nichel spazzolato anti-impronta							Nero- Pittura
Materiale	304 Inox Acciaio, Ottone, PVC, ABS		201 Inox Acciaio, Ottone, PVC, ABS		Acciaio inossidabile 304, ottone, PVC, ABS			

ELENCO DELLE PARTI

MODELLO		8039FL	6002FL 6012FL 8124FL	Numero di modello: 7009FL			
Portatile Doccia		1 pz	1 pz	1 pz	1 pz	1 pz	1 pz
1,5 metri Mano Spray <small>Tubo flessibile</small>		1 pz	1 pz	1 pz	1 pz	1 pz	1 pz
Mano Sedile a spruzzo		1 pz	1 pz	1 pz	1 pz	1 pz	0 pezzi
1/2 Destra Angolo Adattatore		2 pezzi	2 pezzi	2 pezzi	2 pezzi	2 pezzi	2 pezzi
4 punti Gomma		2 pezzi	2 pezzi	2 pezzi	2 pezzi	2 pezzi	2 pezzi
<small>Se stesso</small> toccando Vite		4 pezzi	4 pezzi	4 pezzi	4 pezzi	4 pezzi	4 pezzi
Fissaggio		2 pezzi	2 pezzi	2 pezzi	2 pezzi	2 pezzi	2 pezzi
Occhiello		1 pz	1 pz	1 pz	1 pz	1 pz	2 pezzi
Esagono Noce		1 pz	1 pz	1 pz	1 pz	1 pz	1 pz

MODELLO		8039FL	6002FL 6012FL 8124FL	Numero di modello: 7009FL			
Dado M6		4 pezzi	4 pezzi	0 pezzi	0 pezzi	0 pezzi	0 pezzi
M6*10 Vite		4 pezzi	4 pezzi	0 pezzi	0 pezzi	0 pezzi	0 pezzi
Fascetta stringitubo		2 pezzi	2 pezzi	0 pezzi	0 pezzi	0 pezzi	0 pezzi
Ottone Braccio doccia		0 pezzi	0 pezzi	1 pezzo	1 pz	1 pz	0 pz
Pannello Borsa di cotone		1 pz	1 pz	1 pz	1 pz	1 pz	
Spruzzo superiore Borsa di cotone		1 pz	1 pz	0 pz	0 pz	0 pz	0 pz
Batteria Batteria AA1.5V		2 pezzi	2 pezzi	2 pezzi	0 pezzi	2 pezzi	0 pezzi
Inossidabile Acciaio Uscita acqua Braccio		0 pezzi	0 pezzi	0 pezzi	0 pezzi	0 pezzi	1 pz
Esagonale in ottone Noce		0 pezzi	0 pezzi	0 pezzi	0 pezzi	0 pezzi	1 pezzo
Uscita acqua Adattatore		0 pezzi	0 pezzi	0 pezzi	0 pezzi	0 pezzi	1 pz
Montato a parete Cabina di verniciatura		0 pezzi	0 pezzi	0 pezzi	0 pezzi	0 pezzi	1 pz

ISTRUZIONI DI MONTAGGIO

MODELLO 6012FL/6002FL/8039FL/8124FL



1
Inserire il tubo in PVC dall'apertura superiore per perforarlo.



2
Far passare il filo della luce LED lungo il foro inserito nella scheda madre.



3
Fissare la scheda madre e lo spray superiore con 4 paia di viti M6 e dadi.

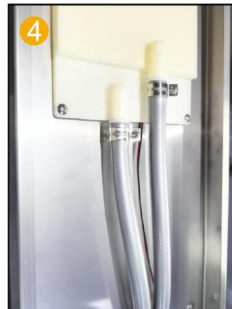

4
Fissare il tubo in PVC con una fascetta stringitubo sul giunto di spruzzatura superiore.

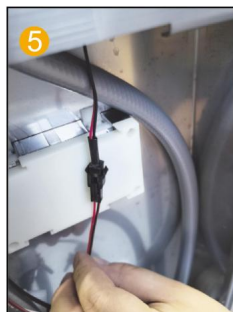

5
Collegare il cavo della luce LED e la linea di alimentazione.

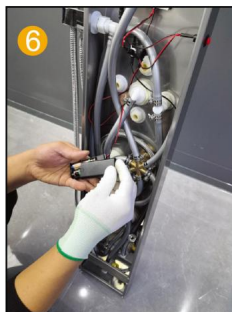

6
Inserire 2 batterie AA nel vano batterie.

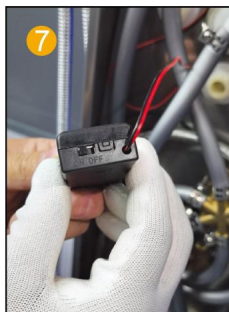

7
Accendere il vano batteria.



8
Inserire l'ugello spruzzatore manuale nel pannello e installare la guarnizione.



9
Inserire l'ugello spruzzatore manuale nel pannello e installare la guarnizione.

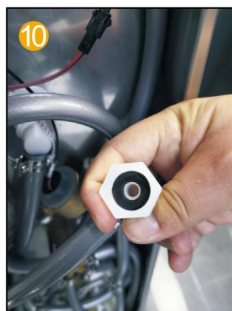

10
Inserire la gomma a 4 punti Collegare l'acqua al connettore di uscita dello spruzzatore manuale e all'interno del giunto del sedile dello spruzzatore manuale.

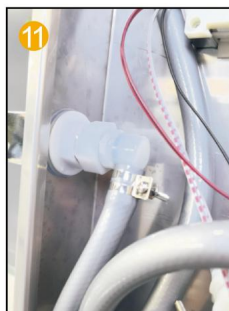

12
Collegare il tubo flessibile della doccia alla doccetta portatile.

MODELLO 7009FL/7016FL/7002FL

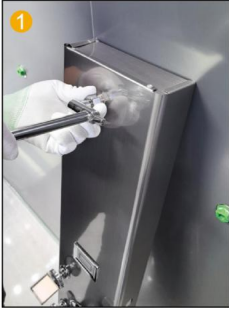

1 Fissare il braccio di scarico dell'acqua alla scheda principale.



2 Collegare lo spruzzo superiore e il braccio di uscita dell'acqua giunto.

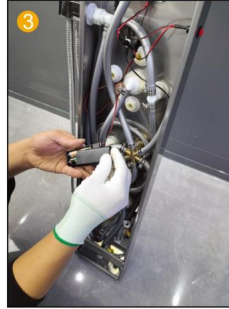

3 Caricare 2 batterie AA in la batteria scomparto.

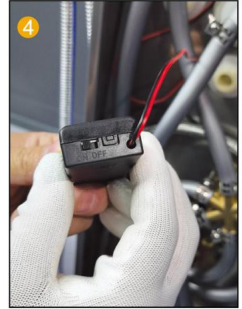

4 Cambiare la scatola della batteria su ON.



5 Inserire l'ugello spruzzatore manuale nel pannello e installare la guarnizione.



6 Inserire l'ugello spruzzatore manuale nel pannello e installare la guarnizione.



7 Metti la gomma a 4 vie nel connettore del spruzzatore manuale per sedile.

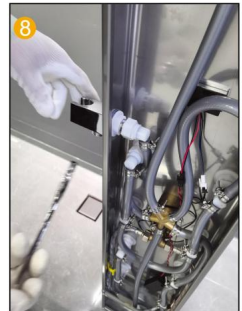

8 Collegare il connettore di uscita dell'acqua alla mano connettore del sedile di spruzzatura.



9 Collegare il palmare tubo flessibile della doccia e il soffione doccia portatile.

Nota: 7016FL senza passaggi 3 e 4.

MODELLO 7015FY



1 Fissare il braccio di scarico dell'acqua alla scheda principale con dadi e rondelle.

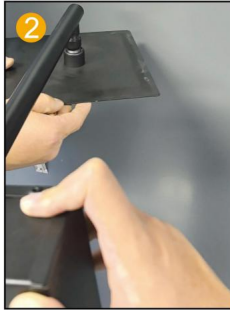

2 Collegare lo spruzzo superiore e il braccio di uscita dell'acqua giunto.



3 Collegare il filo di acciaio tubo e il braccio della doccia e stringerlo.

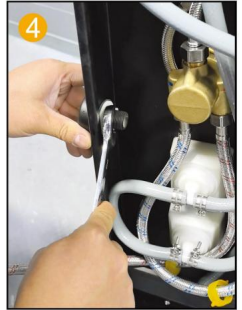

4 Fissare il connettore di uscita della doccia al pannello con un dado.



5 Metti la gomma a 4 vie nella doccia connettore.

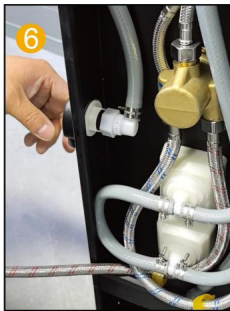

6 Collegare il connettore di uscita dell'acqua e il connettore per uscita acqua soffione doccia.



7 Riparare il soffione della doccia staffa al muro al posizione appropriata con viti e dadi.



8 Installazione del supporto per soffione doccia completato.



9 Fissare il pannello alla parete all'altezza appropriata con la staffa.



10 Collegare il palmare soffione doccia al tubo flessibile.



11 Connetti al soffione doccia portatile.



12 Installazione completata.

FASI DI INSTALLAZIONE (GENERALI)

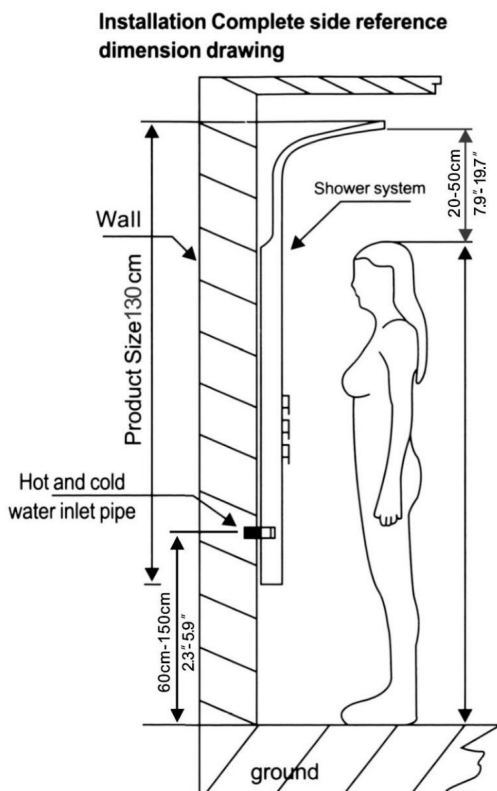
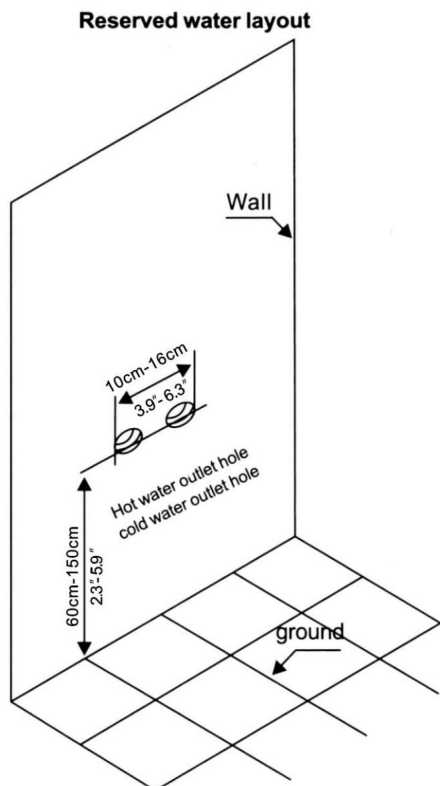

Note di installazione

1. In base all'altezza di installazione del sistema doccia del budget per l'altezza della famiglia, misurare la distanza del sistema doccia sul retro della barra, segnare sul muro, nella posizione corrispondente del ferro appeso fissato all'etichetta (su e giù per ciascuno).
2. Collegare il tubo dell'acqua calda e fredda (assicurarsi di pulire il caricatore e lo sporco nella parete in modo che il calcare non si ostruisca e non comprometta l'effetto dell'acqua).
3. Sistema doccia appeso alla parete, le due schede superiore e inferiore sono state fissate in due paste sospese (Nota: dopo la doccia il sistema a parete, il corpo principale vicino alla parete non trema, non è necessario utilizzare un'altra colla per vetri e altri strumenti fissi).

Metodi di manutenzione del sistema doccia in acciaio inossidabile:

1. Pulizia regolare del prodotto per mantenerne l'aspetto brillante e pulito;
2. Pulire la superficie con acqua o un detergente delicato e asciugarla con un panno morbido.
3. Si noti che il prodotto pulito della posizione nascosta, la pulizia tempestiva può rendere prodotti durevoli.

SCHEMA DI INSTALLAZIONE DELLA SERIE PANNELLO DOCCIA

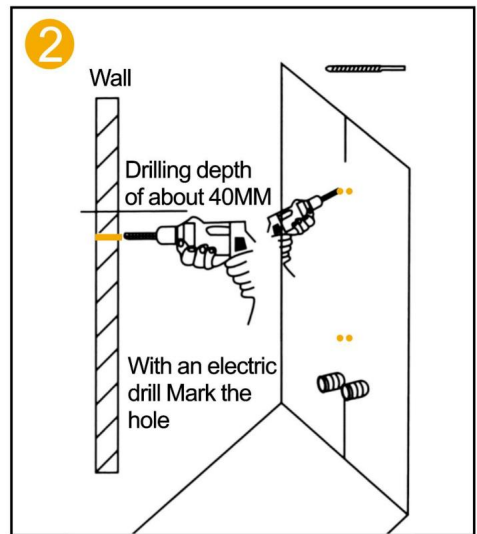
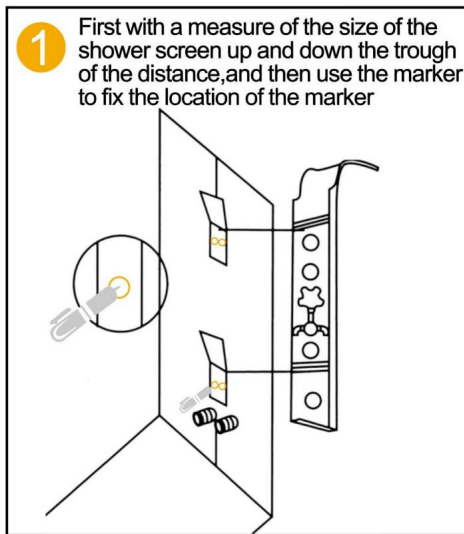

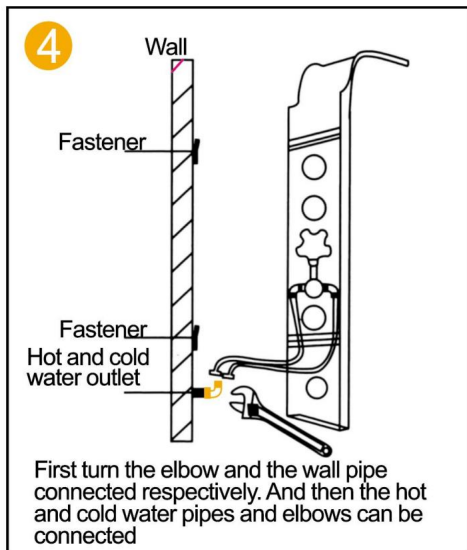
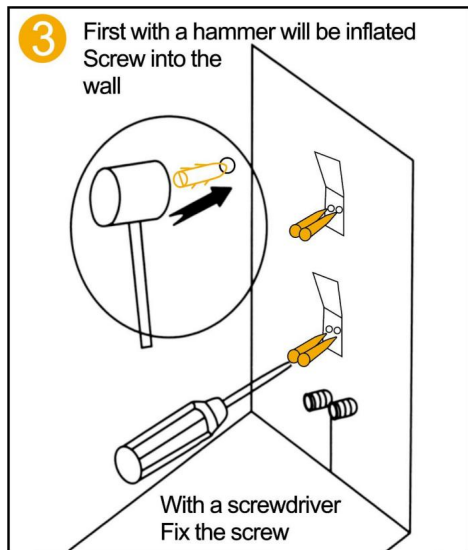

INTRODUZIONE ALLA FUNZIONE

Modello 6002FL / 6012FL



INTRODUZIONE ALLA FUNZIONE

8039FL

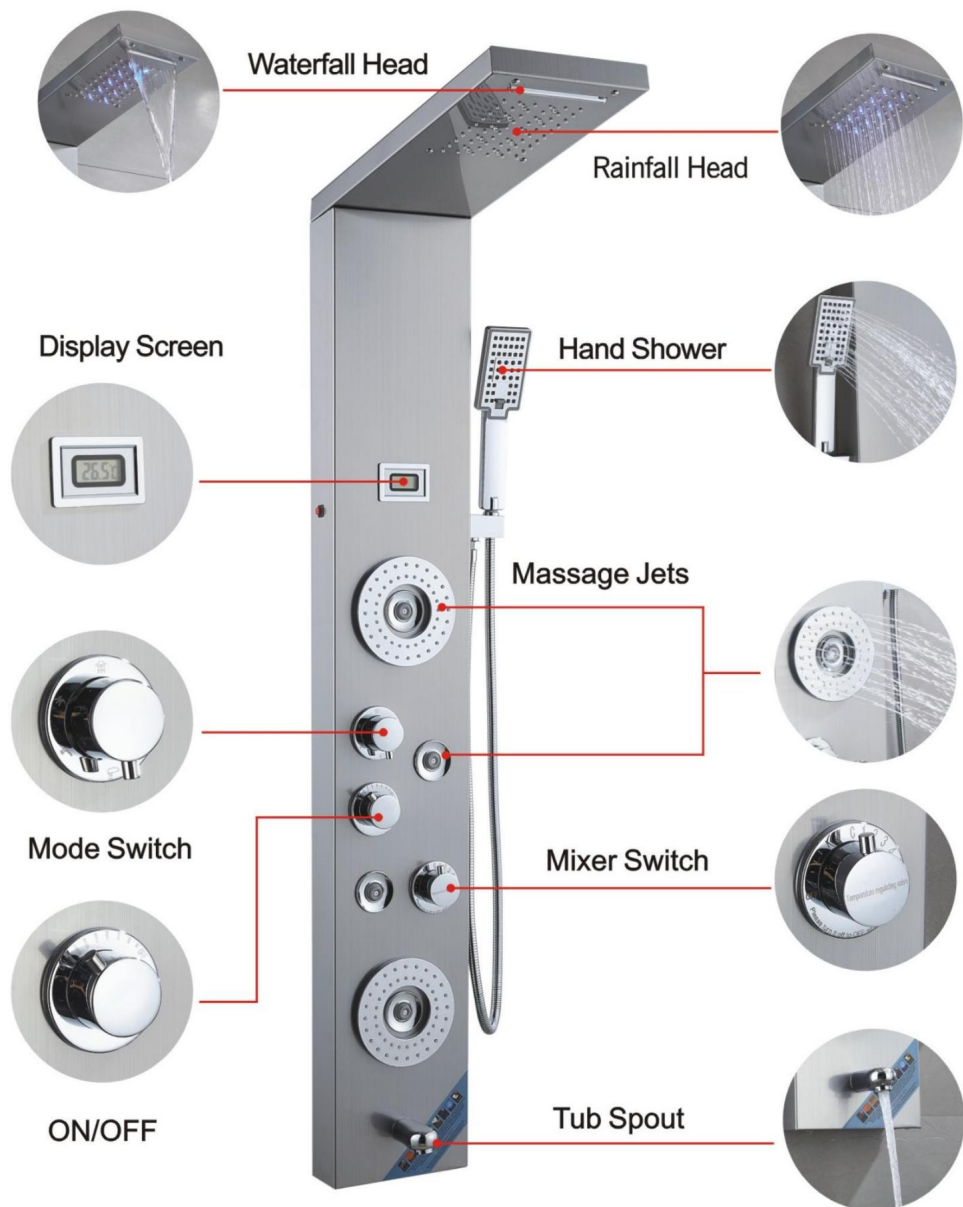

INTRODUZIONE ALLA FUNZIONE

7009FL

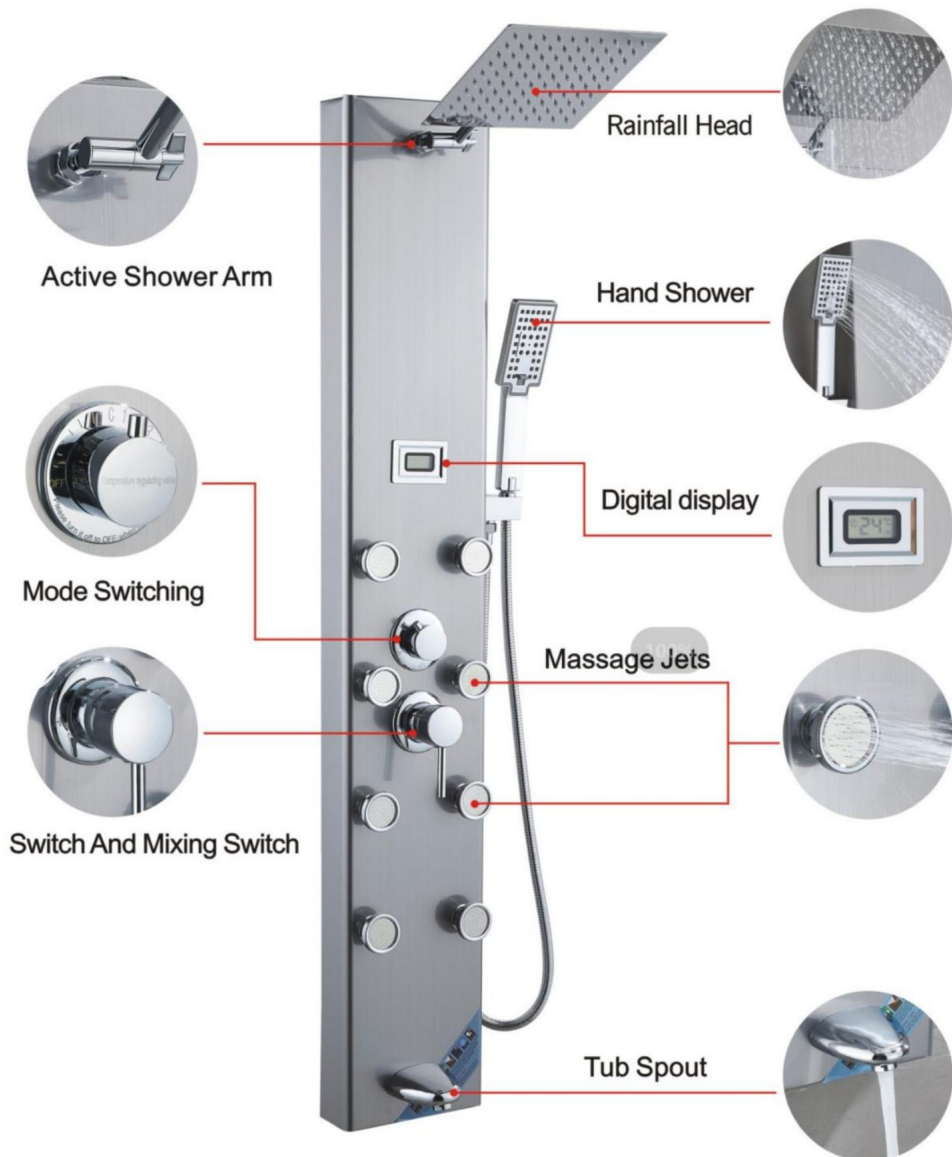

INTRODUZIONE ALLA FUNZIONE

8124FL



INTRODUZIONE ALLA FUNZIONE

7016FL

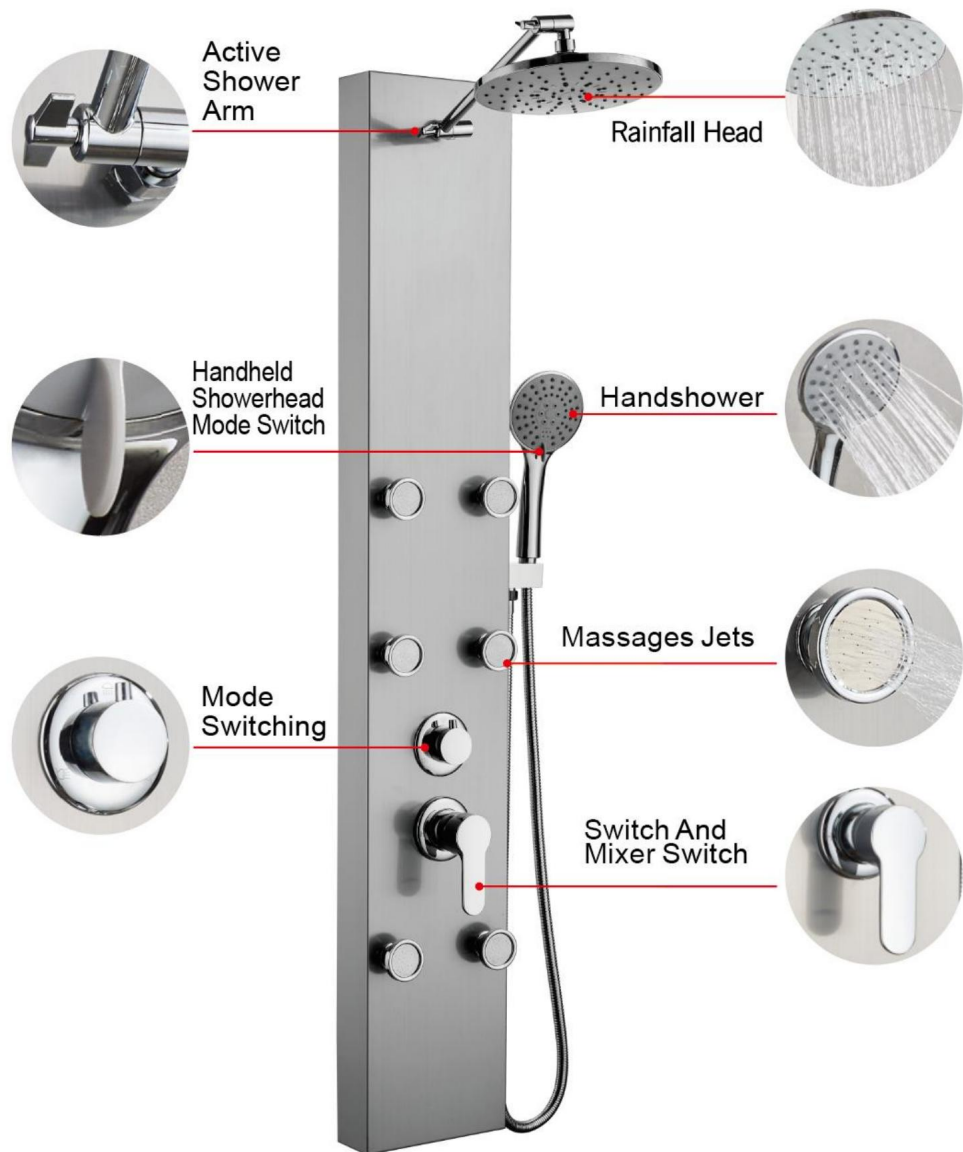

INTRODUZIONE ALLA FUNZIONE

7002FL

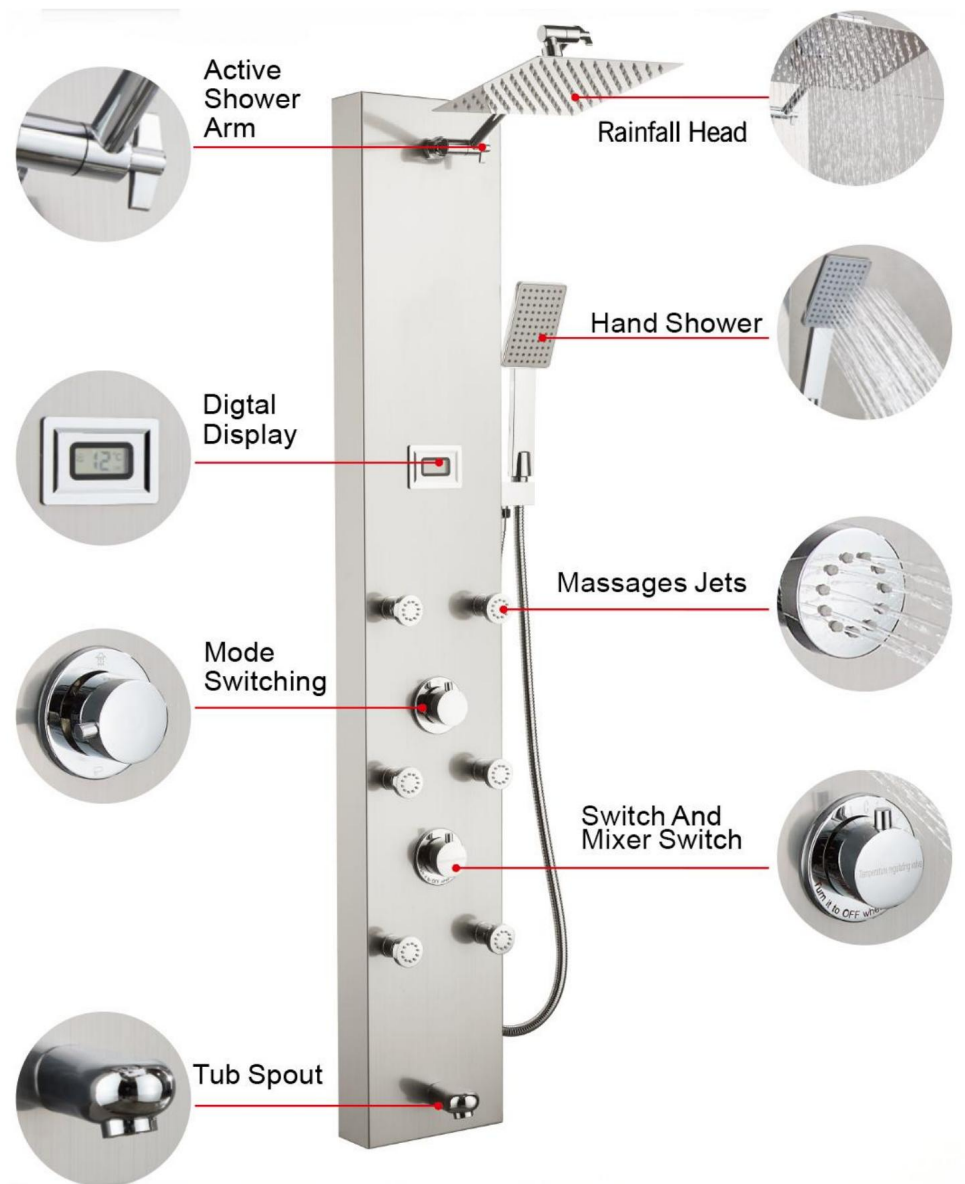

INTRODUZIONE ALLA FUNZIONE

7015FY

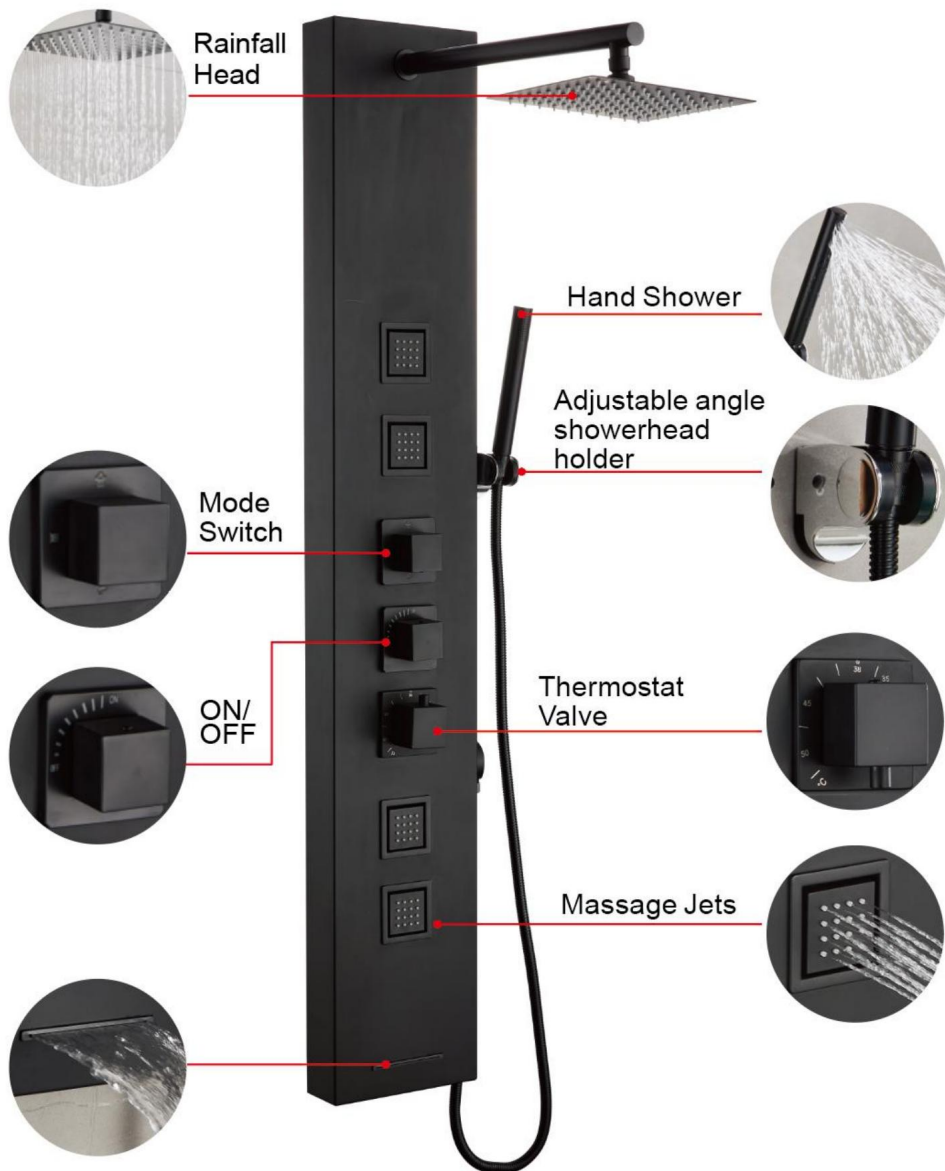

Nota: per il video di installazione dettagliato, fare riferimento al modello corrispondente e scansiona il codice QR qui sotto per visualizzarlo.

Modello 6002FL / 6012FL



8039FL



8124FL



7009FL



7016FL



7002FL



7015FY



Supporto tecnico e certificato di garanzia elettronica
www.vevor.com/support

VEVOR

Affordable. Reliable. Home Improvement.

TORRE DE PANEL DE DUCHA

MODELO:

6002FL, 8039FL, 7009FL, 6012FL, 8124FL, 7016FL, 7002FL, 7015FY

Soporte técnico y certificado de garantía

electrónica www.vevor.com/support

VEVOR

Affordable. Reliable. Home Improvement.

TORRE DE PANEL DE DUCHA





6002FL

6012FL

8039FL 8124FL 7009FL 7016FL 7002FL 7015FY

Estas son las instrucciones originales, lea atentamente todas las instrucciones del manual antes de utilizar el producto. VEVOR se reserva una interpretación clara de nuestro manual de usuario. La apariencia del producto estará sujeta al producto que recibió. Perdónenos por no informarle nuevamente si hay actualizaciones de tecnología o software en nuestro producto.

	<p>Advertencia: Para reducir el riesgo de lesiones, el usuario debe leer Lea atentamente el manual de instrucciones.</p>
	<p>Este dispositivo cumple con la Parte 15 de las Normas de la FCC. Su funcionamiento es sujeto a las dos condiciones siguientes: (1) Este dispositivo no puede causar interferencia dañina, y (2) este dispositivo debe aceptar cualquier interferencia recibidas, incluidas las interferencias que puedan provocar un funcionamiento no deseado.</p>
	<p>Este producto está sujeto a las disposiciones de la Directiva Europea 2012/19/CE. El símbolo que muestra un contenedor de basura tachado indica que el producto requiere recolección de residuos por separado en el Unión Europea. Esto se aplica al producto y a todos los accesorios. marcados con este símbolo. Los productos marcados como tal no pueden desecharse con la basura doméstica normal, sino que deben llevarse a un Punto de recogida para el reciclaje de aparatos eléctricos y electrónicos</p>

INSTRUCCIONES

Consejos de advertencia:

1. Durante el proceso de instalación, es mejor usar guantes para evitar objetos afilados. esquinas del panel para evitar que se rayen la palma de la mano.
2. Al instalar la ducha, asegúrese de que todas las juntas estén completamente Apretado para evitar fugas de agua.
3. Asegúrese de que las tuberías de entrada de agua roja y azul dentro del panel no estén en una posición Estado plegado para evitar afectar la presión del agua.
4. Cuando la ducha no esté en uso, cierre la válvula de interruptor de la ducha.













GUARDE ESTAS INSTRUCCIONES

INSTRUCCIONES DE INSTALACIÓN

Modelo	6002FL 8039FL 6012FL 8124FL 7009FL 7016FL 7002FL 7015FY							
Montaje Tipo	Montaje en pared							
Conexión Hilo	G1/2"							
Funciones	Cuatro Modos	Seis Modos	Cinco Modos	Cinco Modos	Cinco Modos	Tres Modos	Cuatro Modos	Cuatro Modos
Caño de bañera	√	√	√	√	√	x	√	√
Temperatura Mostrar	x	√	x	x	√	x	√	x
Lámpara LED	√	√	√	√	x	x	x	x
Fuerza	Pila seca (CC 3 V)	Pila seca (CC 3 V)	Pila seca (CC 3 V)	Pila seca (CC 3 V)	Pila seca (CC 3 V)	x	Pila seca (CC 3 V)	x
Mano Ducha	1 configuración	3 configuraciones	1 configuración	1 configuración	3 configuraciones	5 configuraciones	1 configuración	1 configuración
Finalizar	Sistema de ducha de níquel cepillado sin huellas dactilares							Negro- Cuadro
Material	Acero inoxidable 304 Acero, latón, PVC, ABS		201 inoxidable Acero, latón, PVC, ABS		Acero inoxidable 304, latón, PVC, ABS			

LISTA DE PIEZAS

MODELO		8039FL	6002FL 6012FL 8124FL	7009FL 7016FL	7002FL	7015FY	
Portátil Ducha		1 pieza	1 pieza	1 pieza	1 pieza	1 pieza	1 pieza
1,5 metros Mano Pulverización Manguera		1 pieza	1 pieza	1 pieza	1 pieza	1 pieza	1 pieza
Mano Asiento con rociador		1 pieza	1 pieza	1 pieza	1 pieza	1 pieza	0 piezas
1/2 Derecha Ángulo Adaptador		2 piezas	2 piezas	2 piezas	2 piezas		2 piezas
4 puntos Goma		2 piezas	2 piezas	2 piezas	2 piezas		2 piezas
Ser Tocando Tornillo		4 piezas	4 piezas	4 piezas	4 piezas		4 piezas
Cierre		2 piezas	2 piezas	2 piezas	2 piezas		2 piezas
Ojal		1 pieza	1 pieza	1 pieza	1 pieza	1 pieza	2 piezas
Hexágono Tuerca		1 pieza	1 pieza	1 pieza	1 pieza	1 pieza	1 pieza

MODELO		8039FL	6002FL 6012FL 8124FL	7009FL 7016FL	7002FL 7015FY		
Tuerca M6		4 piezas	4 piezas	0 piezas	0 piezas	0 piezas	0 piezas
M6*10 Tornillo		4 piezas	4 piezas	0 piezas	0 piezas	0 piezas	0 piezas
Abrazadera de manguera		2 piezas	2 piezas	0 piezas	0 piezas	0 piezas	0 piezas
Latón Brazo de ducha		0 piezas	0 piezas	1 piezas	1 pieza	1 pieza	0 piezas
Panel Bolsa de algodón		1 pieza	1 pieza	1 pieza	1 pieza	1 pieza	1 pieza
Rociado superior Bolsa de algodón		1 pieza	1 pieza	0 piezas	0 piezas	0 piezas	0 piezas
Batería Batería AA de 1,5 V		2 piezas	2 piezas	2 piezas	0 piezas	2 piezas	0 piezas
Inoxidable Acero Salida de agua Brazo		0 piezas	0 piezas	0 piezas	0 piezas	0 piezas	1 pieza
Hexágono de latón Tuerca		0 piezas	0 piezas	0 piezas	0 piezas	0 piezas	1 piezas
Salida de agua Adaptador		0 piezas	0 piezas	0 piezas	0 piezas	0 piezas	1 pieza
Montado en la pared Cabina de pintura		0 piezas	0 piezas	0 piezas	0 piezas	0 piezas	1 pieza

INSTRUCCIONES DE MONTAJE

MODELO 6012FL/6002FL/8039FL/8124FL



1
Inserte el tubo de PVC desde la abertura superior para perforarlo.



2
Pase el cable de luz LED a lo largo del orificio de inserción en la placa base.



3
Fije la placa base y el rociador superior con 4 pares de tornillos y tuercas M6.

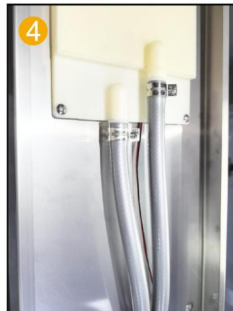

4
Fije el tubo de PVC con una abrazadera de garganta en la junta de rociado superior.

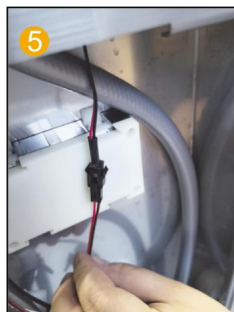

5
Conecte el cable de luz LED y la línea de alimentación.

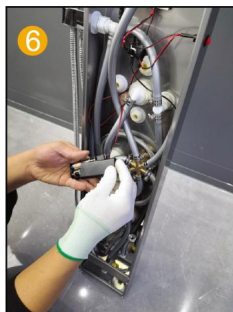

6
Coloque 2 pilas AA en el compartimento de las pilas.

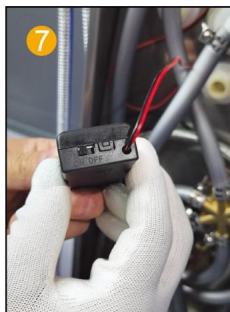

7
Encienda la caja de la batería.



8
Inserte la boquilla rociadora manual en el panel e instale la junta.



9
Inserte la boquilla rociadora manual en el panel e instale la junta.

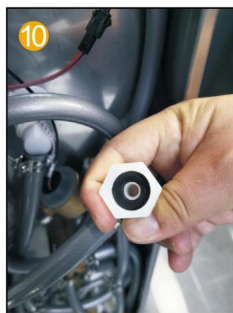

10
Coloque el conector de goma de 4 puntos. Conecte el agua en el conector de salida del rociador manual y dentro de la junta del asiento del rociador manual.

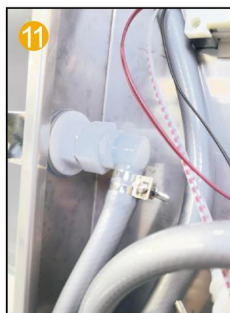

12
Conecte la manguera rociadora manual al cabezal de ducha de mano.

MODELO 7009FL/7016FL/7002FL



1
Ajustar el brazo de salida de agua
A la placa principal.



2
Conecte el rociador superior y el
brazo de salida de agua

articulación.

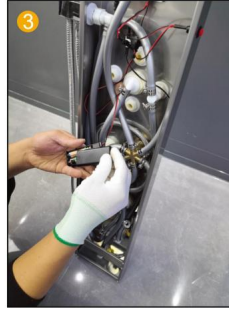

3
Coloque 2 pilas AA en
La batería
compartmento.

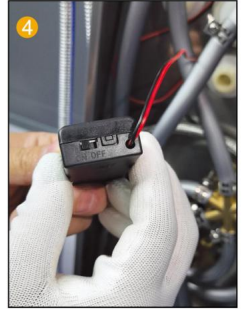

4
Cambie la caja de la batería
Para encender.



5
Inserte la boquilla rociadora
manual en el panel e instale la
junta.

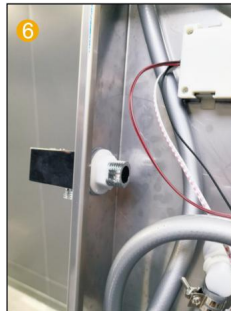

6
Inserte la boquilla rociadora
manual en el panel e instale la
junta.



7
Coloque la goma de 4 vías
en el conector de la
Asiento con rociador de mano.

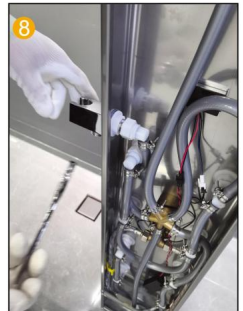

8
Conecte el conector de salida de
agua a la mano.
Conector del asiento de pulverización.



9
Conectar el dispositivo portátil
manguera de ducha y la
cabezal de ducha de mano.

Nota: 7016FL sin pasos 3 y 4.

MODELO 7015FY



1
Arreglar el brazo de salida de agua a la placa principal con Tuercas y arandelas.

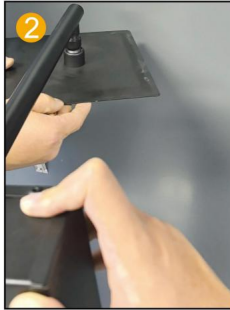

2
Conecte el rociador superior y el brazo de salida de agua

articulación.



3
Conecte el cable de acero tubo y el brazo de la ducha y apriételo.

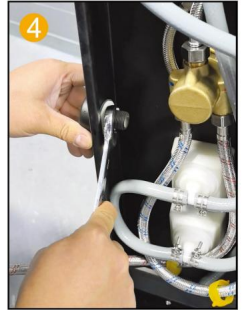

4
Fije el conector de salida de la ducha al panel con una tuerca.



5
Coloque la goma de 4 vías En el cabezal de la ducha Conector.

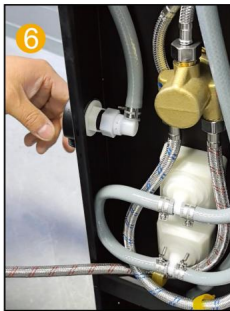

6
Conecte el conector de salida de agua y el Conector de salida de agua del cabezal de ducha.



7
Arreglar el cabezal de la ducha soporte a la pared en el posición apropiada con tornillos y tuercas.



8
Instalación del Soporte de cabezal de ducha completado.



9
Fije el panel a la pared a la altura adecuada con el soporte.



10
Conectar el dispositivo portátil cabezal de ducha a la manguera.



11
Conectarse a la cabezal de ducha de mano.



12
Instalación completada.

PASOS DE INSTALACIÓN (GENERAL)

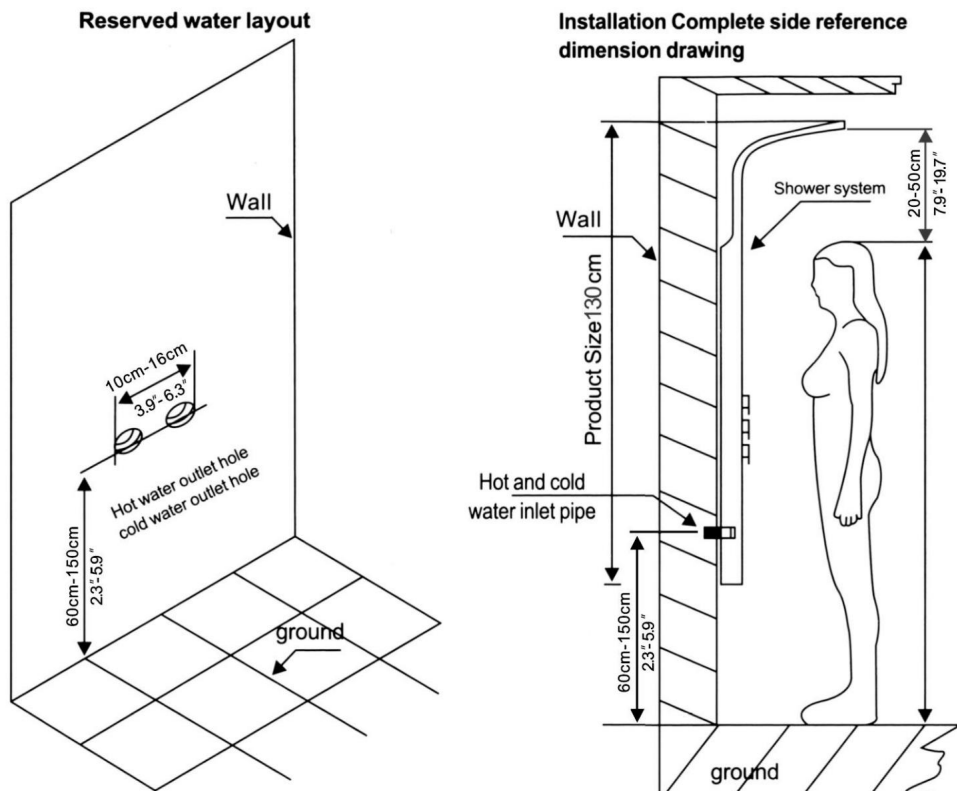

Notas de instalación

1. De acuerdo con la altura de instalación del sistema de ducha de presupuesto familiar, mida la distancia del sistema de ducha en la parte posterior de la barra, marque en la pared, en la posición correspondiente de la etiqueta de hierro fija para colgar (arriba y abajo de cada una).
2. Conecte la manguera de agua fría y caliente (asegúrese de limpiar el cargador y la suciedad en la pared para no bloquear la escala, lo que afecta el efecto del agua).
3. Sistema de ducha colgado en la pared, las dos tarjetas superior e inferior se sujetan con dos pastas para colgar (Nota: después de la ducha, el sistema de pared, el cuerpo principal cerca de la pared no tiembla, no es necesario utilizar otro pegamento para vidrio ni otras herramientas fijas).

Métodos de mantenimiento del sistema de ducha de acero inoxidable:

1. Limpieza periódica del producto para mantener su aspecto brillante y limpio;
2. Limpie la superficie con agua o un detergente suave y séquela con una toalla suave.
3. Tenga en cuenta que el producto limpio de la posición oculta, la limpieza oportuna puede hacer Productos duraderos.

ESQUEMA DE INSTALACIÓN DE LA SERIE DE PANELES DE DUCHA

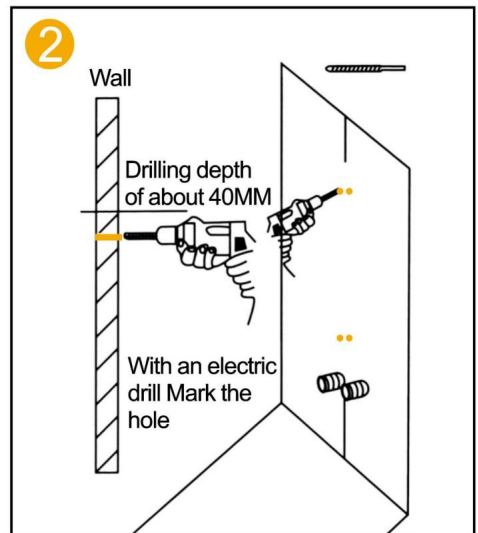
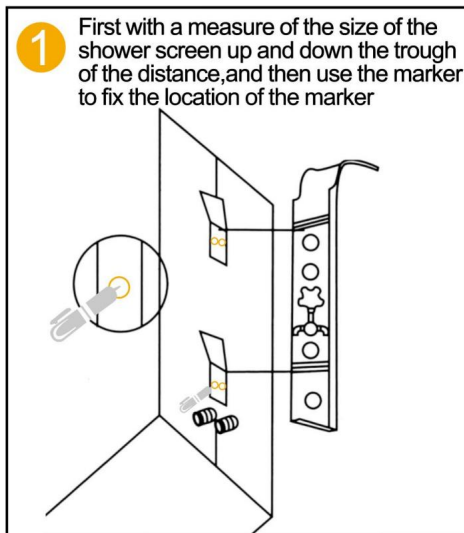

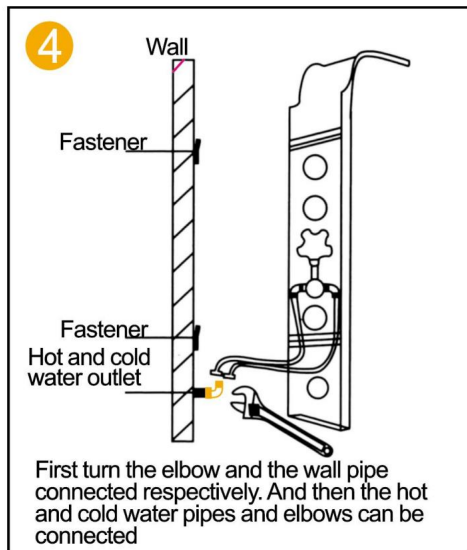
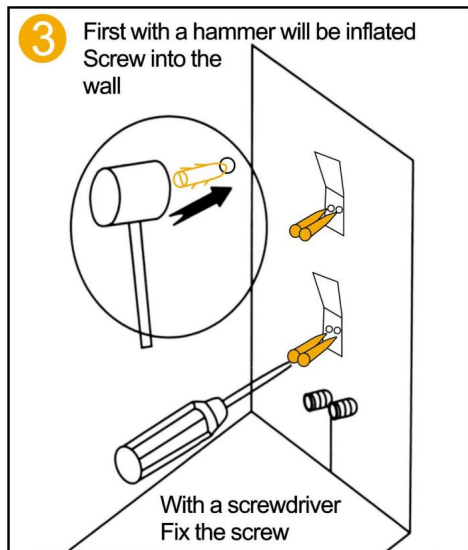

INTRODUCCIÓN DE FUNCIONES

6002FL / 6012FL



INTRODUCCIÓN DE FUNCIONES

8039FL

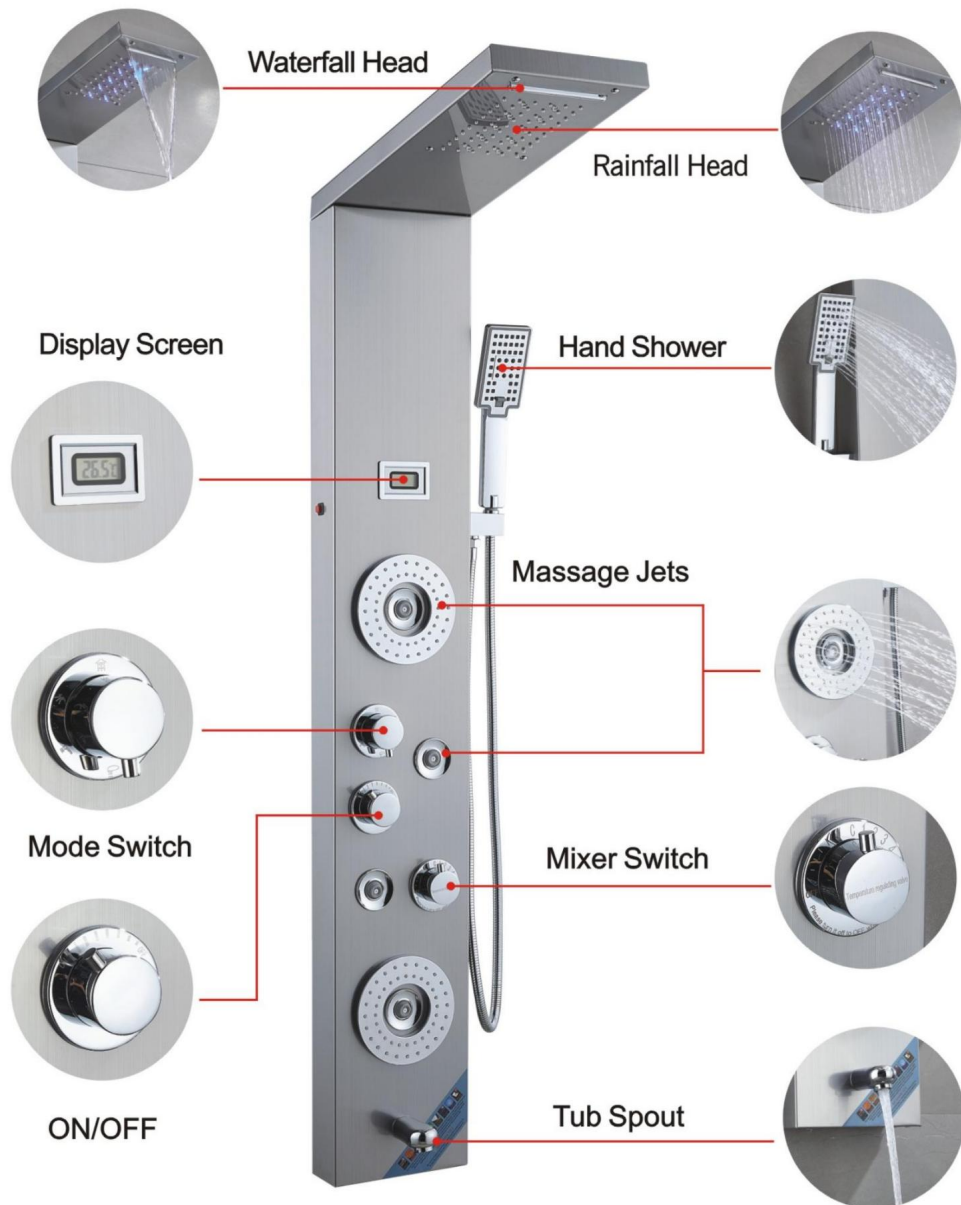

INTRODUCCIÓN DE FUNCIONES

7009FL

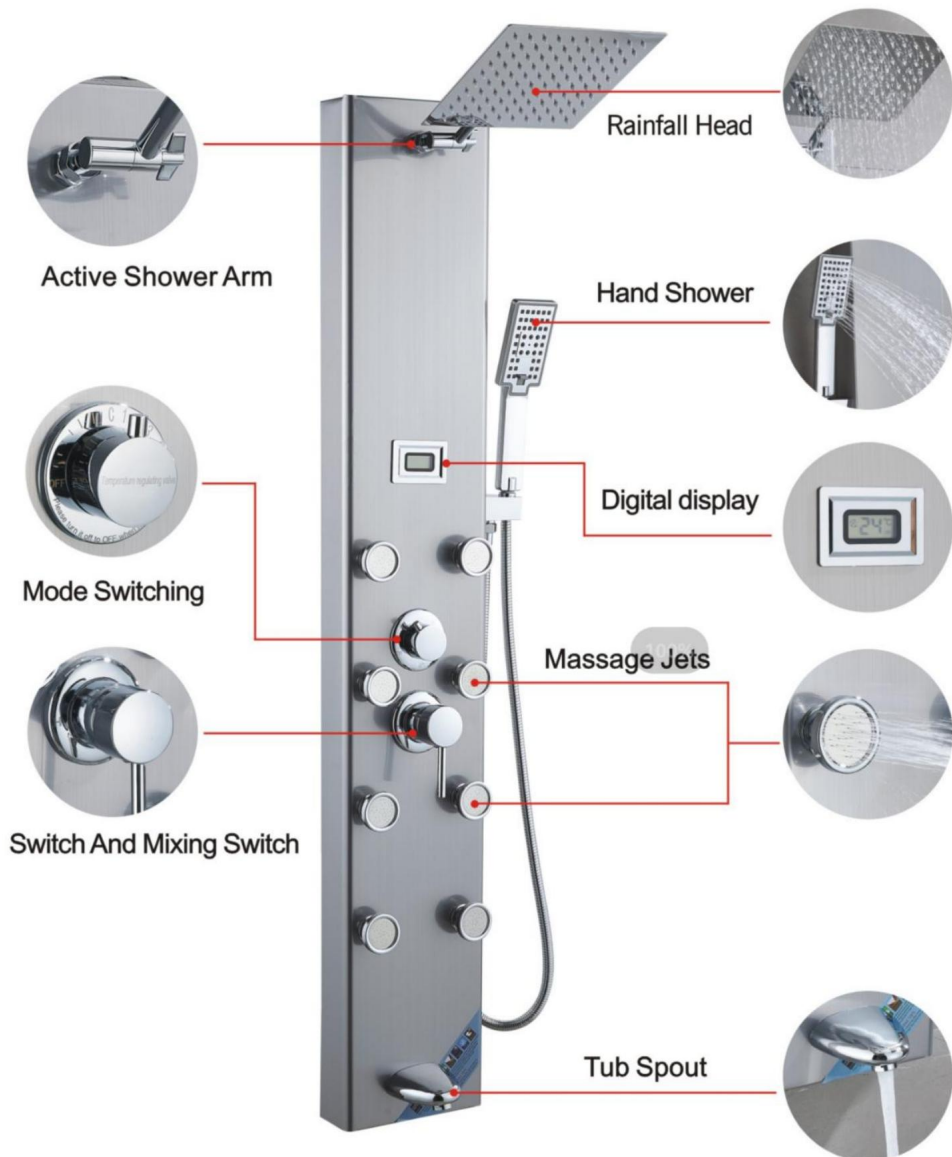

INTRODUCCIÓN DE FUNCIONES

8124FL



INTRODUCCIÓN DE FUNCIONES

7016FL

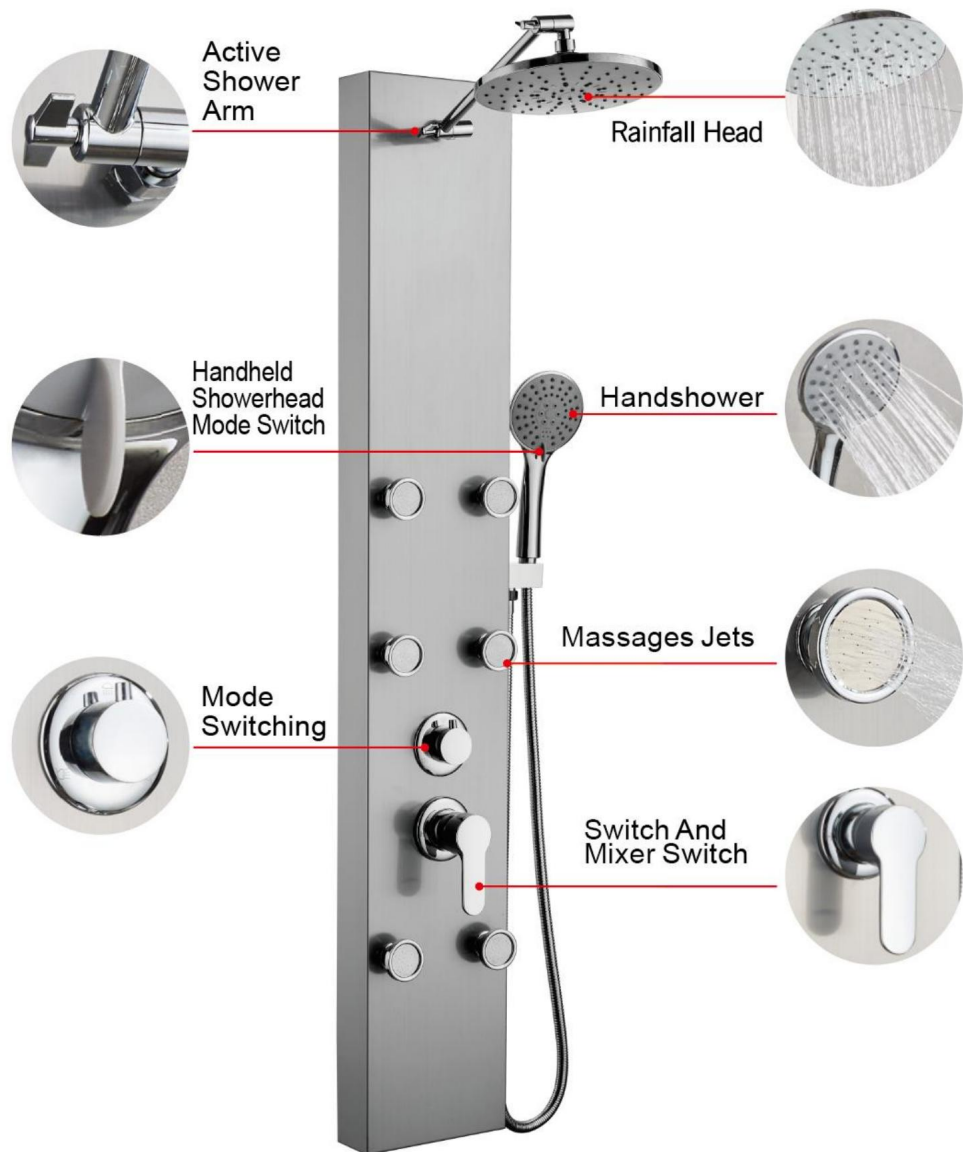

INTRODUCCIÓN DE FUNCIONES

7002FL

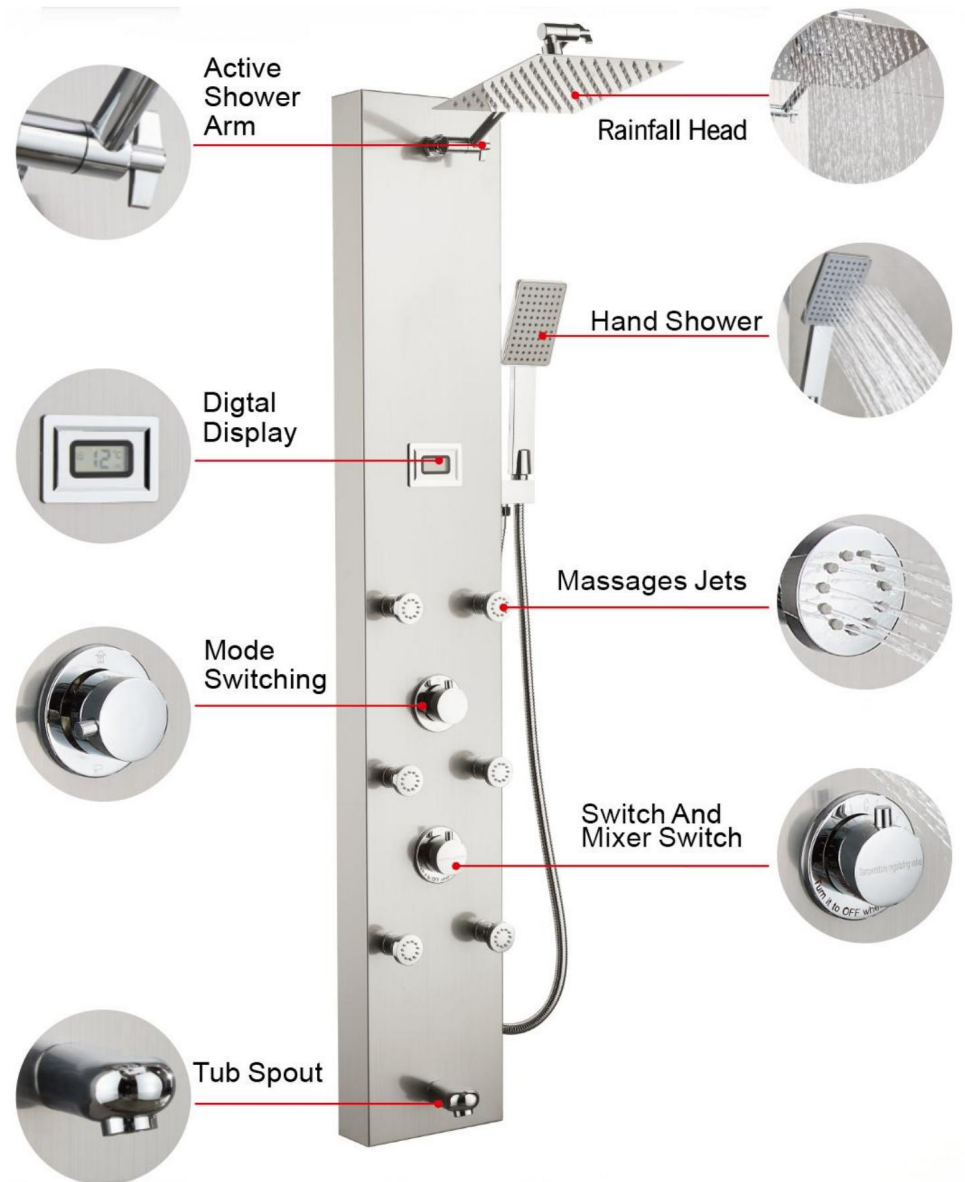

INTRODUCCIÓN DE FUNCIONES

Año fiscal 7015



Nota: Para ver el video de instalación detallado, consulte el modelo correspondiente y escanee el código QR a continuación para verlo.

6002FL / 6012FL



8039FL



8124FL



7009FL



7016FL



7002FL



Año fiscal 7015



Soporte técnico y certificado de garantía electrónica
www.vevor.com/support

VEVOR

Affordable. Reliable. Home Improvement.

PANEL PRYSZNICOWY WIEŻA

MODEL:

6002FL, 8039FL, 7009FL, 6012FL, 8124FL, 7016FL, 7002FL, 7015FY

Wsparcie techniczne i certyfikat gwarancji

elektronicznej www.vevor.com/support

VEVOR

PANEL PRYSZNICOWY WIEŻA



Affordable. Reliable. Home Improvement.



6002FL
6012FL

8039FL 8124FL 7009FL 7016FL 7002FL 7015FY

To jest oryginalna instrukcja, przed użyciem należy uważnie przeczytać wszystkie instrukcje. VEVOR zastrzega sobie jasną interpretację naszej instrukcji obsługi. Wygląd produktu będzie zależał od produktu, który otrzymałeś. Prosimy o wybaczenie, że nie poinformujemy Cię ponownie, jeśli w naszym produkcie pojawią się jakiegokolwiek aktualizacje technologiczne lub oprogramowania.

	<p>Ostrzeżenie – aby zmniejszyć ryzyko obrażeń, użytkownik musi przeczytać</p> <p>Przeczytaj uważnie instrukcję obsługi.</p>
	<p>To urządzenie jest zgodne z częścią 15 przepisów FCC. Działanie jest z zastrzeżeniem następujących dwóch warunków: (1) Urządzenie to nie może powodować szkodliwe zakłócenia, a (2) urządzenie to musi akceptować wszelkie zakłócenia odebrane, w tym zakłócenia, które mogą powodować niepożądane działanie.</p>
	<p>Niniejszy produkt podlega postanowieniom Dyrektywy Europejskiej 2012/19/WE. Symbol przedstawiający przekreślony kosz na śmieci na kółkach oznacza, że produkt wymaga oddzielnej zbiórki odpadów w Unia Europejska. Dotyczy produktu i wszystkich akcesoriów oznaczone tym symbolem. Produkty oznaczone w ten sposób nie mogą być wyrzucać razem z normalnymi odpadami domowymi, lecz należy je oddać do punktu zbiórki odpadów.</p> <p>punkt zbiórki sprzętu elektrycznego i elektronicznego do recyklingu</p>

INSTRUKCJE

Wskazówki ostrzegawcze:

1. Podczas instalacji najlepiej jest założyć rękawice, aby zapobiec uszkodzeniom ostrym narożniki panelu od zarysowań wnętrza dłoni.
2. Podczas montażu prysznica należy upewnić się, że wszystkie połączenia są w pełni dokręcone. dokręcone, aby zapobiec wyciekaniu wody.
3. Upewnij się, że czerwone i niebieskie rury doprowadzające wodę wewnątrz panelu znajdują się w miejscu, w którym nie ma w stanie złożonym, aby nie wpływać na ciśnienie wody.
4. Jeżeli nie korzystasz z prysznica, zamknij zawór przełączający prysznica.





















ZAPISZ TE INSTRUKCJE

INSTRUKCJA INSTALACJI

Model	6002FL 8039FL 6012FL 8124FL 7009FL 7016FL 7002FL 7015FY							
Montowanie Typ	Montaż ścienny							
Połączenie Nitka	G1/2"							
Funkcje	Cztery Tryby	Sześć Tryby	Pięć Tryby	Pięć Tryby	Pięć Tryby	Trzy Tryby	Cztery Tryby	Cztery Tryby
Wylewka wannowa						x		
Temperatura Wyświetlacz	x		x	x		x		x
Lampa LED					x	x	x	x
Moc	Komórka sucha (prąd stały 3V)	Komórka sucha (prąd stały 3V)	Komórka sucha (prąd stały 3V)	Komórka sucha (prąd stały 3V)	Komórka sucha (prąd stały 3V)	x	Komórka sucha (prąd stały 3V)	x
Ręka Prysznic	1-Ustawienie	3-Ustawienie	1-Ustawienie	1-Ustawienie	3-Ustawienie	5-Ustawienie	1-Ustawienie	1-Ustawienie
Skończyć	System prysznicowy z szrotkowanego niklu bez odcisków palców							Czarny- Malarstwo
Tworzywo	Stal nierdzewna 304 Stal, Mosiądz, PCV, ABS		201 Stal nierdzewna Stal, Mosiądz, PCV, ABS		Stal nierdzewna 304, mosiądz, PVC, ABS			

LISTA CZĘŚCI

MODEL		8039FL	6002FL 6012FL 8124FL	7009FL 7016	6FL 7002FL 7015	FY	
Ręczny Prysznic	 Lub	1 szt.	1 szt.	1 szt.	1 szt.	1 szt.	1 szt.
1,5 metra Ręka Rozpylać <small>Wąż gumowy</small>		1 szt.	1 szt.	1 szt.	1 szt.	1 szt.	1 szt.
Ręka <small>Siedzisko natryskowe</small>		1 szt.	1 szt.	1 szt.	1 szt.	1 szt.	0 szt.
1/2 w prawo Kąt Adapter		2szt.	2szt.	2szt.	2szt.		2 szt. 2 szt.
4-punktowy Guma		2szt.	2szt.	2szt.	2szt.		2 szt. 2 szt.
Ja Stukający Śruba		4szt.	4szt.	4szt.	4szt.	4szt.	4 szt. 4 szt.
Łącznik		2szt.	2szt.	2szt.	2szt.		2 szt. 2 szt.
Przelotka		1 szt.	1 szt.	1 szt.	1 szt.	1 szt.	1 szt. 2 szt.
Sześciokąt <small>Nakrętka</small>		1 szt.	1 szt.	1 szt.	1 szt.	1 szt.	1 szt. 1 szt.

MODEL		8039FL	6002FL 6012FL 8124FL	7009FL	7016FL	7002FL	7015FY	
Nakrętka M6		4 szt.	4 szt.	0 szt.	0 szt.	0 szt.	0 szt.	
M6*10 Śruba		4 szt.	4 szt.	0 szt.	0 szt.	0 szt.	0 szt.	
Zacisk węża		2szt.	2szt.	0szt.	0szt.	0szt.	0szt.	
Mosiądz Ramię prysznicowe		0szt	0szt	1szt		1 szt.	1 szt.	0 szt.
Płyta Torba bawełniana		1 szt.	1 szt.	1 szt.	1 szt.	1 szt.	1 szt.	
Górny spray Torba bawełniana		1 szt.	1 szt.	0 szt.	0 szt.	0 szt.	0 szt.	
Bateria AA1,5V		2szt.	2szt.	2szt.	0szt.	2szt.	0szt.	
Nierdzewny Stal Wylot wody Ramię		0szt	0szt	0szt	0szt	0szt		1 szt.
Mosiężny sześciokąt Nakrętka		0szt	0szt	0szt	0szt	0szt	1szt	
Wylot wody Adapter		0szt	0szt	0szt	0szt	0szt		1 szt.
Montaż na ścianie Kabina lakiernicza		0szt	0szt	0szt	0szt	0szt		1 szt.

INSTRUKCJA MONTAŻU

MODEL 6012FL/6002FL/8039FL/8124FL



1 Włóż rurę PCV od górnego otworu, aby ją przebić.



2 Poprowadź przewód diody LED wzdłuż otworu w płycie głównej.



3 Zamocuj płytę główną i górną osłonę za pomocą 4 par śrub M6 i nakrętek.

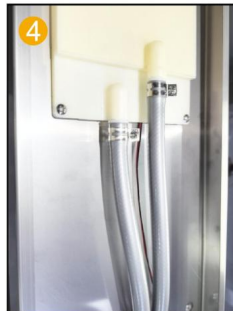

4 Zamocuj rurę PCV za pomocą zacisku gardzielowego na górnym złączu natryskowym.

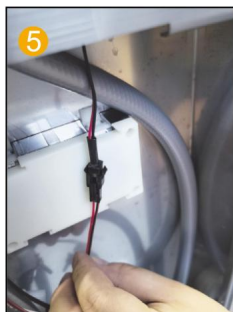

5 Podłącz kabel oświetlenia LED i przewód zasilający.

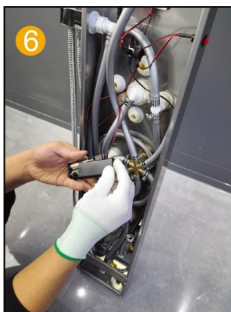

6 Włóż 2 baterie AA do komory baterii.

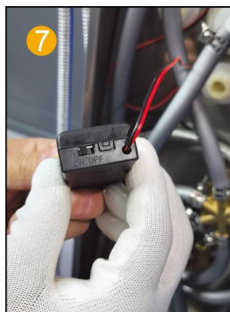

7 Przełącz pojemnik na baterie w pozycję ON.



8 Włóż dyszę spryskiwacza do panelu i zamontuj uszczelkę.

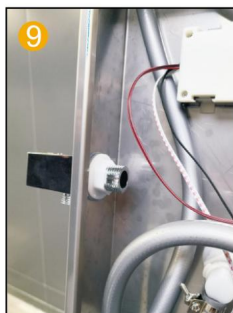

9 Włóż dyszę spryskiwacza do panelu i zamontuj uszczelkę.

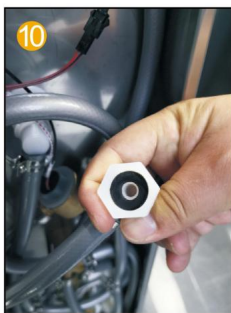

10 Podłącz 4-punktową gumę do złącza wylotowego spryskiwacza ręcznego i do wnętrza stawu gniazda spryskiwacza ręcznego.

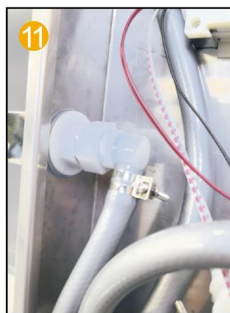

12 Podłącz wąż natrysku ręcznego do słuchawki przysłanicowej.

MODEL 7009FL/7016FL/7002FL

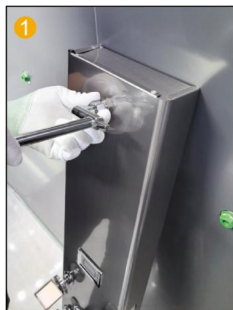

1 Napraw ramię wylotu wody do płyty głównej.



2 Podłącz górny natrysk i ramię wylotu wody wspólny.

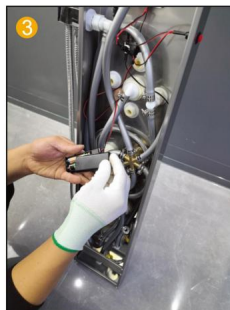

3 Włóż 2 baterie AA do baterie przedział.



4 Zmień skrzynkę baterii na WŁ.



5 Włóż dyszę spryskiwacza do panelu i zamontuj uszczelkę.

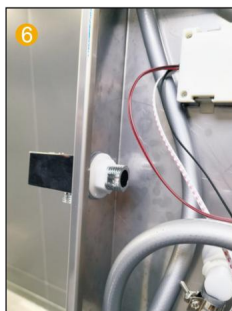

6 Włóż dyszę spryskiwacza do panelu i zamontuj uszczelkę.

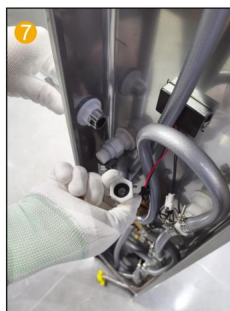

7 Załóż gumę 4-kierunkową do złącza siedzisko z ręcznym natryskiem.

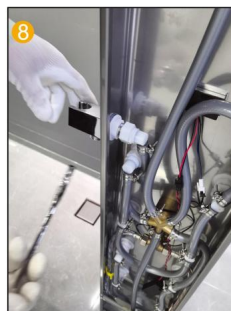

8 Podłącz złącze wylotu wody do ręki łącznik gniazda natryskowego.



9 Podłącz urządzenie przenośne wąż prysznicowy i słuchawka prysznicowa ręczna.

Uwaga: 7016FL nie wykonuje kroków 3 i 4.

MODEL 7015FY



1
Napraw ramię wylotu wody do płyty głównej z nakrętki i podkładki.

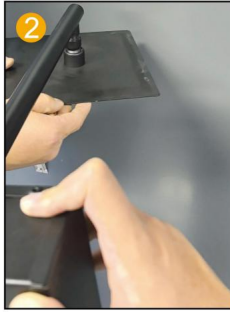

2
Podłącz górny natrysk i ramię wylotu wody wspólny.



3
Podłącz drut stalowy rurę i ramię natrysku, a następnie dokręć je.



4
Przymocuj przyłącze wylotu prysznica do panelu za pomocą nakrętki.

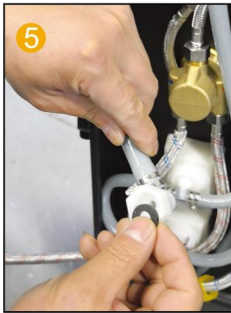

5
Założ gumę 4-kierunkową do słuchawki prysznicowej złącze.



6
Podłącz złącze wylotu wody i złącze wylotu wody do słuchawki prysznicowej.



7
Naprawa głowicy prysznicowej wspornik do ściany przy odpowiednia pozycja z śruby i nakrętki.



8
Instalacja uchwyt na słuchawkę prysznicową ukończony.



9
Za pomocą uchwytu przymocuj panel do ściany na odpowiedniej wysokości.



10
Podłącz urządzenie przenośne głowica prysznicowa do węzeł gumowy.



11
Połącz się z słuchawką prysznicową.



12
Instalacja ukończona.

KROKI INSTALACJI (OGÓLNE)

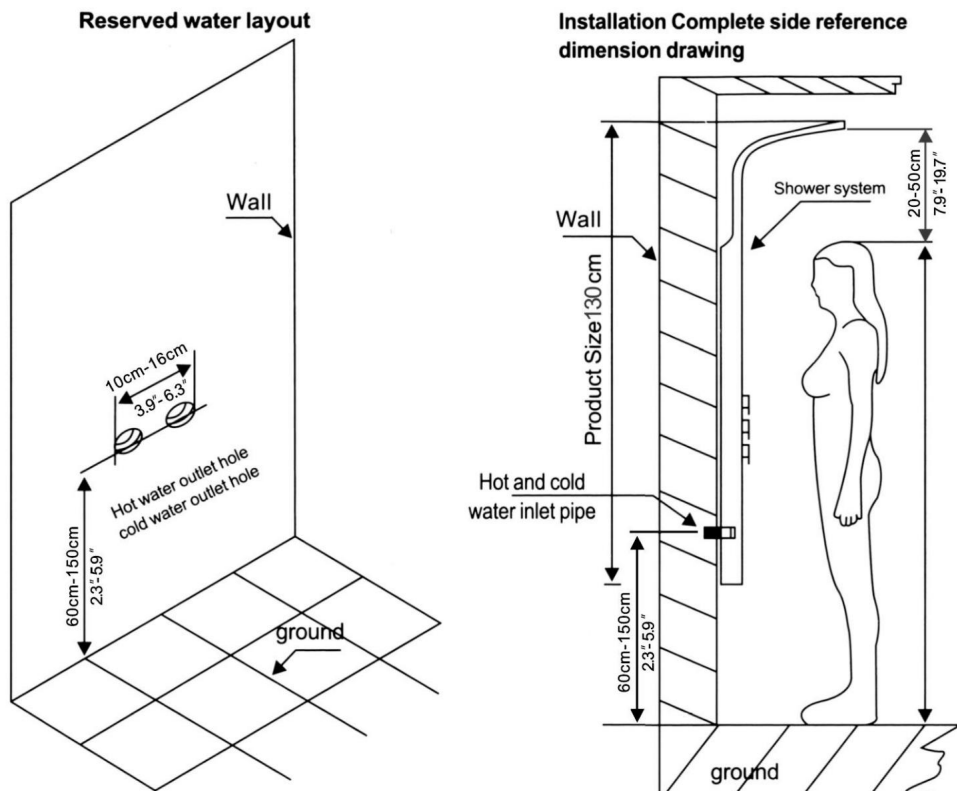

Notatki dotyczące instalacji

1. Zgodnie ze wzrostem rodziny, wysokość instalacji systemu prysznicowego zmierz z tyłu drążka. Odległość systemu prysznicowego zaznacz na ścianie w odpowiedniej pozycji przymocowanego wieszaka żelaznego (w górę i w dół).
2. Podłącz wąż doprowadzający ciepłą i zimną wodę (pamiętaj o dokładnym wyczyszczeniu magazynka i usunięciu zanieczyszczeń z kamienia w ścianie, aby nie dopuścić do jego zablokowania, co mogłoby wpłynąć na przepływ wody).
3. System prysznicowy zawieszony na ścianie, górna i dolna karta zostały zamocowane na dwóch klejach do zawieszania (Uwaga: po zamontowaniu systemu na ścianie, główna część prysznica blisko ściany nie trzęsie się, nie ma potrzeby używania kolejnego kleju do szkła i innych narzędzi mocujących).

Metody konserwacji systemów prysznicowych ze stali nierdzewnej:

1. Regularne czyszczenie produktu w celu zachowania jego jasnego wyglądu i czysty;
2. Wyczyść powierzchnię wodą lub łagodnym detergentem i wytrzyj ją miękkim ręcznikiem.
3. Należy pamiętać, że czysty produkt w ukrytej pozycji, terminowe czyszczenie może sprawić, że produkty trwale.

SCHEMAT INSTALACJI SERII PANELÓW PRYSZNICOWYCH

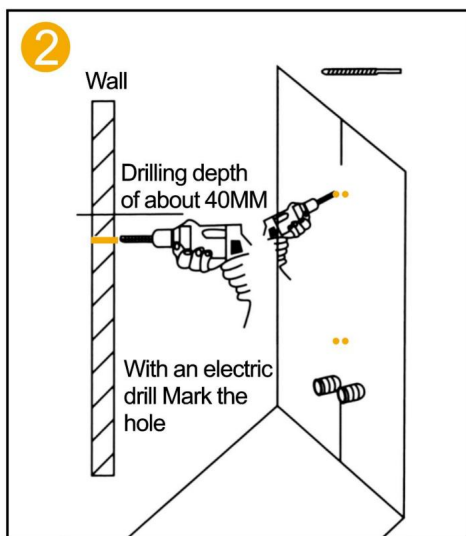
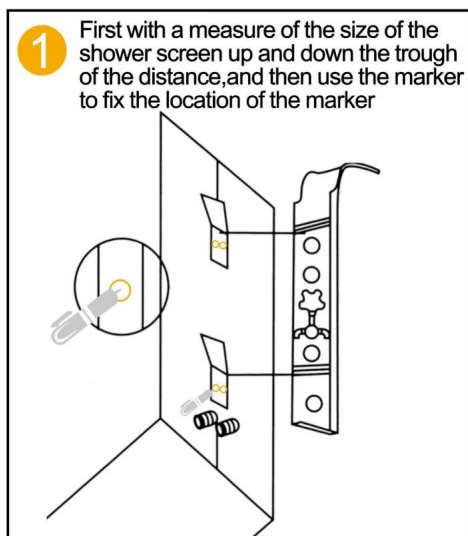

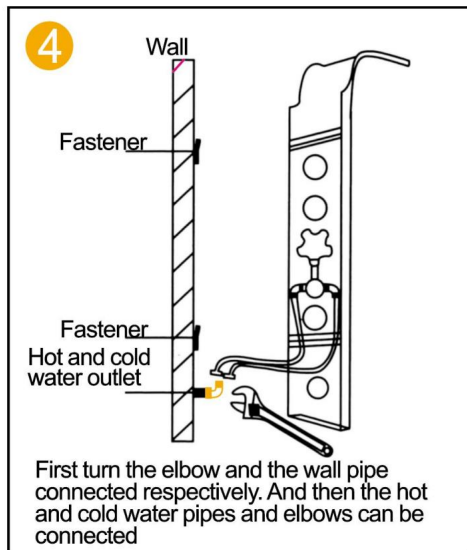
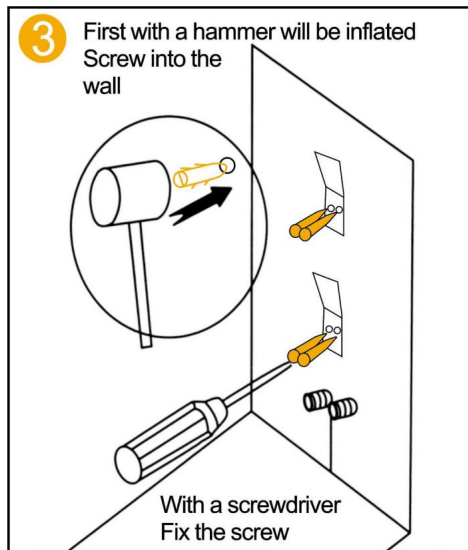

WPROWADZENIE DO FUNKCJI

6002FL / 6012FL



WPROWADZENIE DO FUNKCJI

8039FL

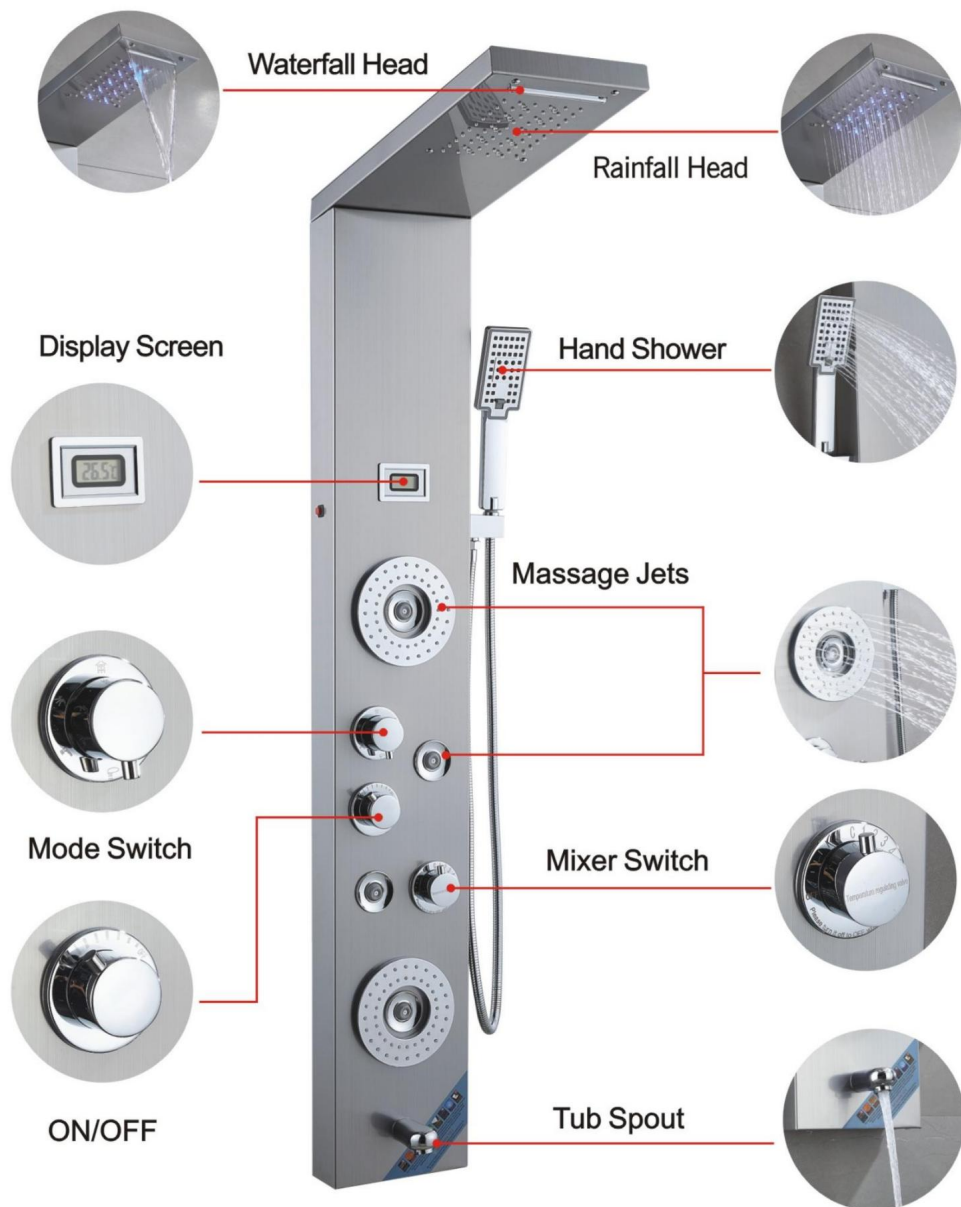

WPROWADZENIE DO FUNKCJI

7009FL

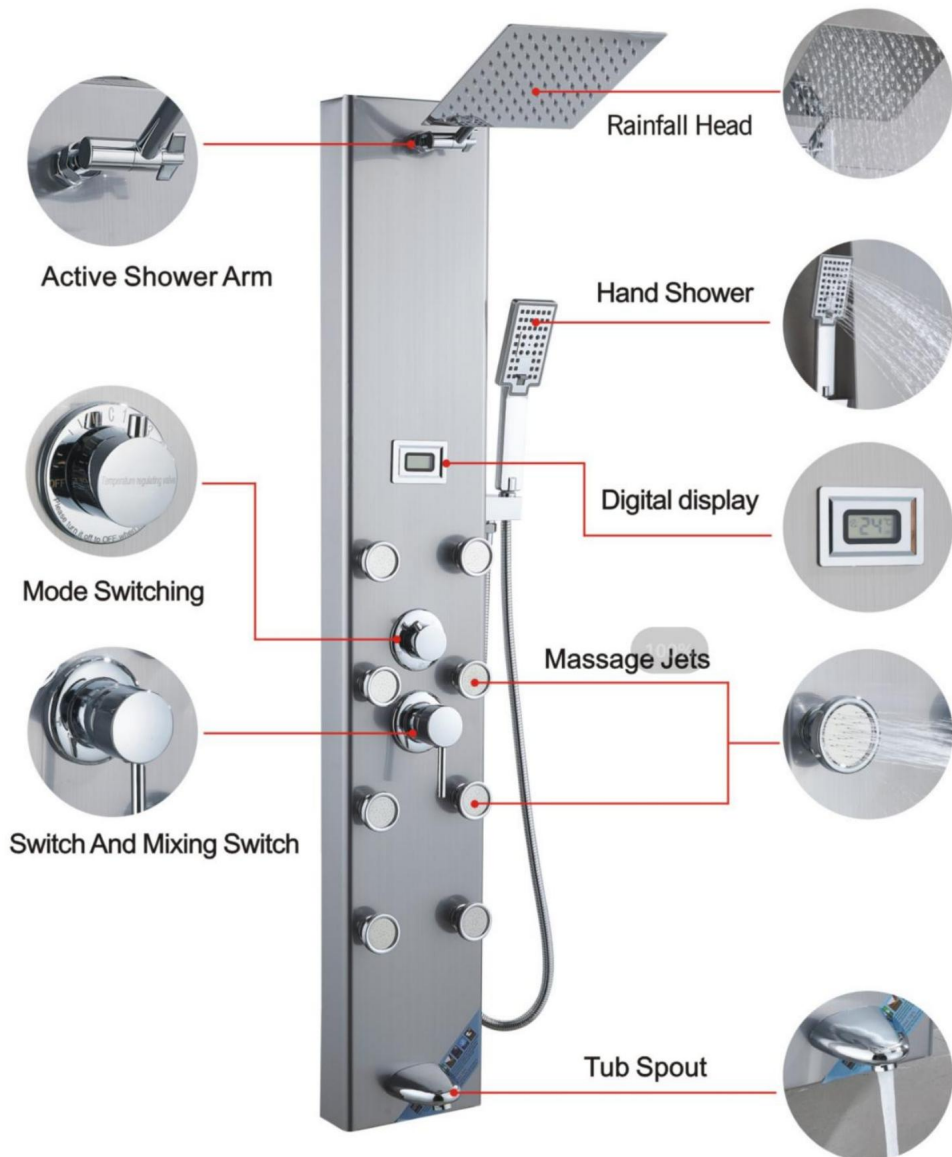

WPROWADZENIE DO FUNKCJI

8124FL



WPROWADZENIE DO FUNKCJI

7016FL

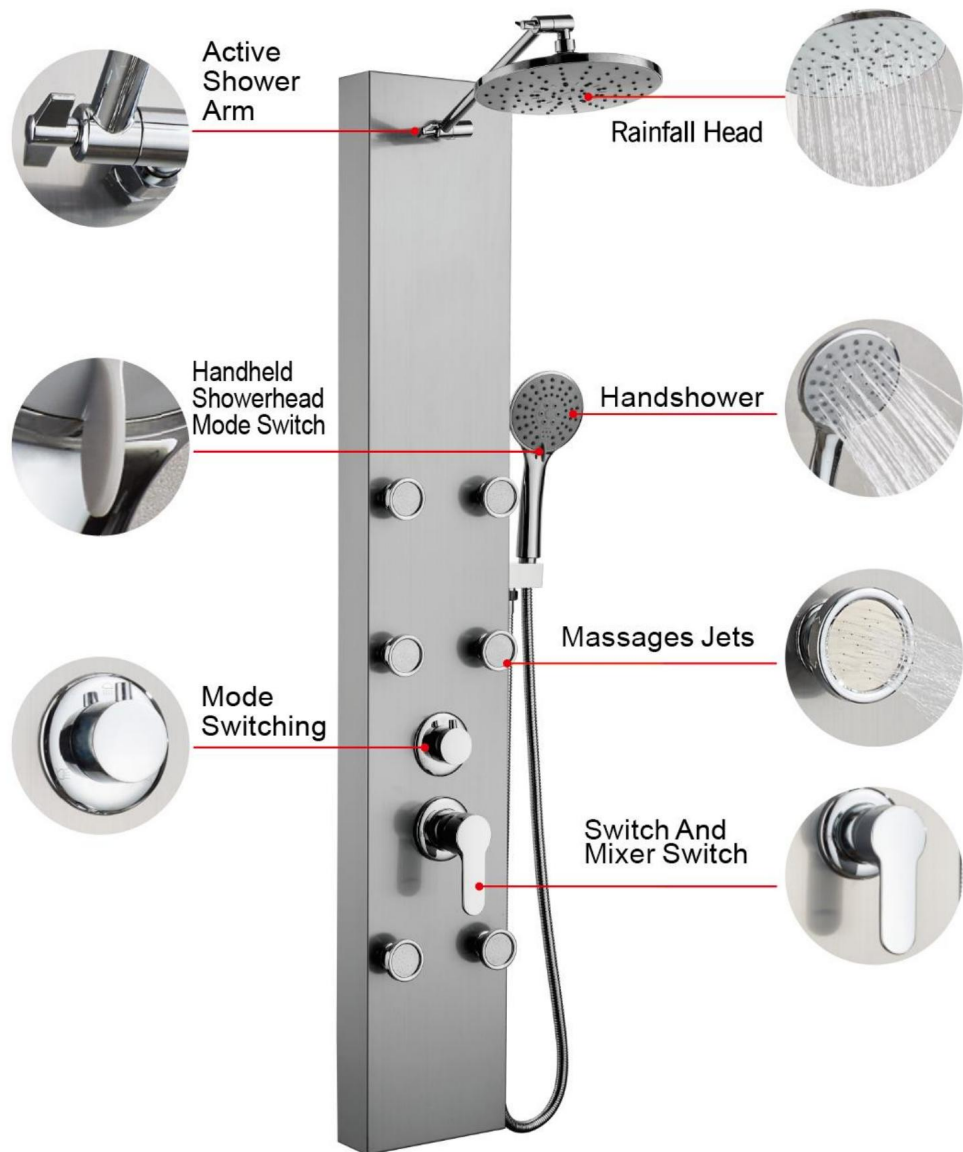

WPROWADZENIE DO FUNKCJI

7002FL

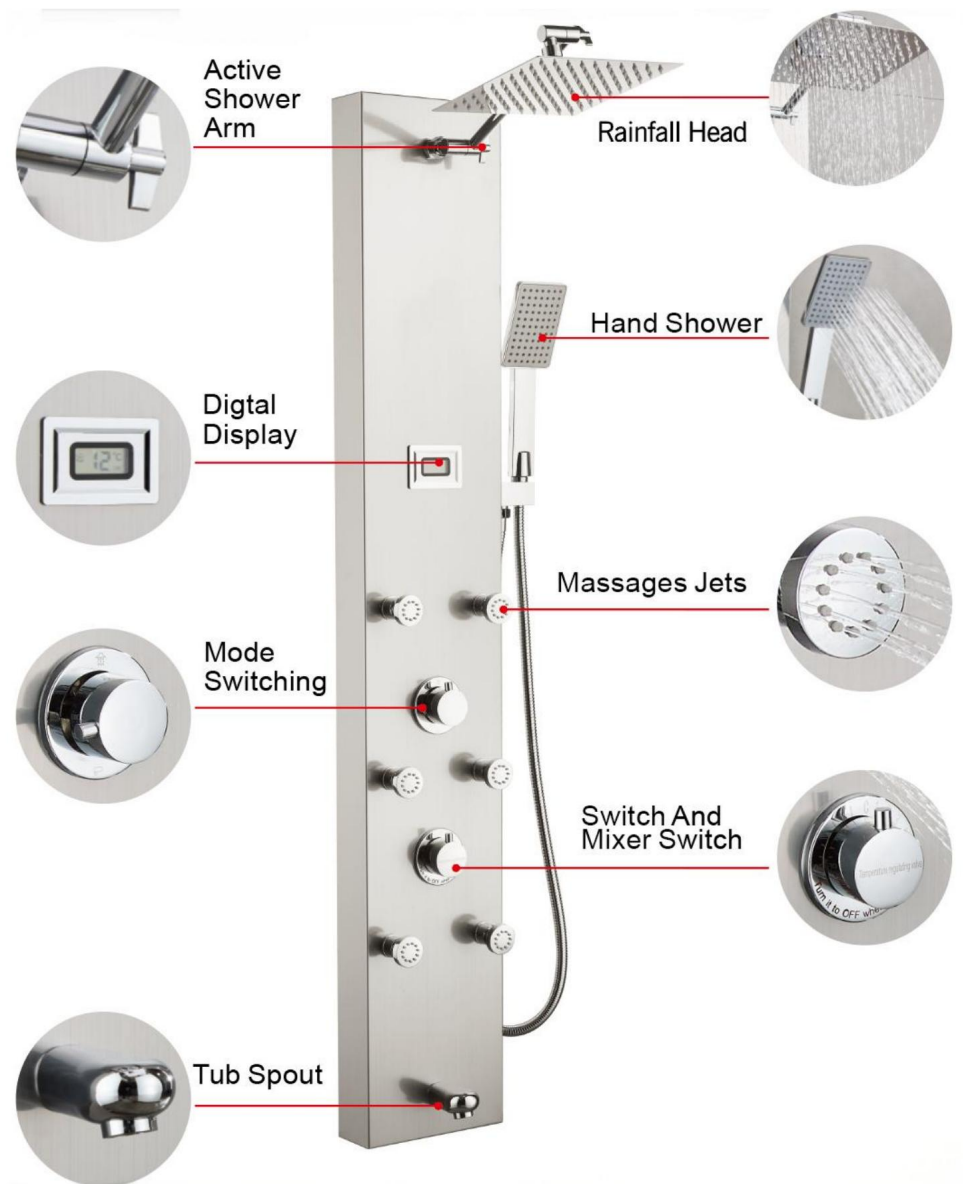

WPROWADZENIE DO FUNKCJI

7015rok podatkowy

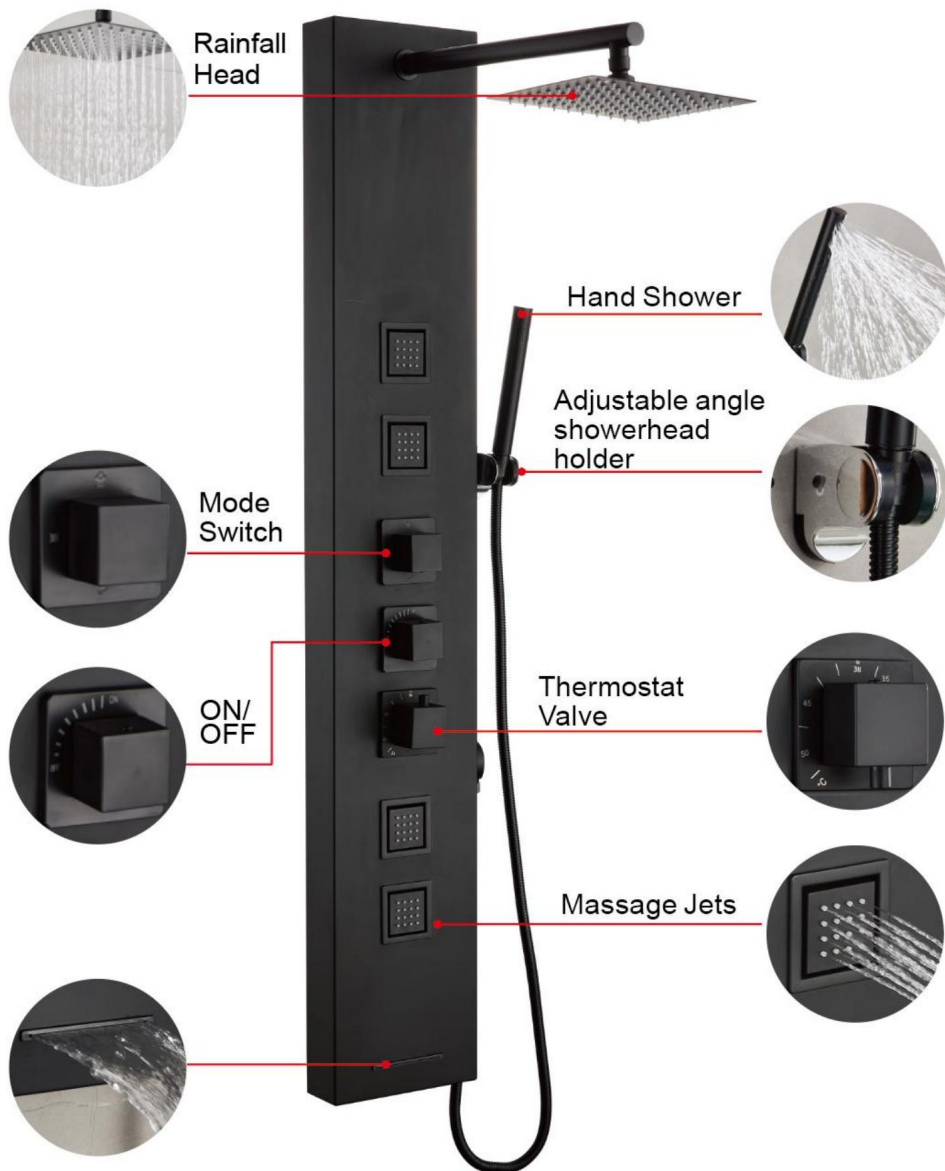

Uwaga: Aby obejrzeć szczegółowy film instruktażowy dotyczący instalacji, zapoznaj się z odpowiedni model i zeskanuj poniższy kod QR, aby wyświetlić.

6002FL / 6012FL



8039FL



8124FL



7009FL



7016FL



7002FL



7015rok podatkowy



Wsparcie techniczne i certyfikat e-gwarancji
www.vevor.com/support

VEVOR

Affordable. Reliable. Home Improvement.

DUSCHPANELTORN

MODELL:

6002FL, 8039FL, 7009FL, 6012FL, 8124FL, 7016FL, 7002FL, 7015FY

Teknisk support och e-garanticertifikat

www.vevor.com/support

VEVOR DUSCHPANELTORN



Affordable. Reliable. Home Improvement.



6002FL
6012FL

8039FL 8124FL 7009FL 7016FL 7002FL 7015FY

Detta är den ursprungliga instruktionen, läs alla instruktioner noggrant innan du använder den. VEVOR reserverar sig för en tydlig tolkning av vår användarmanual. Utseendet på produkten är beroende av den produkt du fått. Ursäkta oss att vi inte kommer att informera dig igen om det finns någon teknik eller mjukvaruuppdateringar på vår produkt.

	<p>Varning - För att minska risken för skada måste användaren läsa bruksanvisningen noggrant.</p>
	<p>Denna enhet uppfyller del 15 av FCC-reglerna. Operation är med förbehåll för följande två villkor:(1)Denna enhet får inte orsaka skadlig störning, och (2)denna enhet måste acceptera alla störningar mottagna, inklusive störningar som kan orsaka oönskad funktion.</p>
	<p>Denna produkt omfattas av bestämmelserna i det europeiska direktivet 2012/19/EG. Symbolen som visar en soptunna på hjul korsad indikerar att produkten kräver separat sophämtning i Europeiska unionen. Detta gäller produkten och alla tillbehör märkt med denna symbol. Produkter märkta som sådana kanske inte är det kasseras med vanligt hushållsavfall, men måste tas till en insamlingsställe för återvinning av elektriska och elektroniska apparater</p>

INSTRUKTIONER

Varningstips:

1. Under installationsprocessen är det bäst att bära handskar för att förhindra vassa hörn på panelen från att repa handflatan.
2. När du installerar duschen, se till att alla skarvar är helt åtdragna för att undvika vattenläckage.
3. Se till att de röda och blå vatteninloppsroren inuti panelen är i ett icke hopvikt tillstånd för att undvika att vattentrycket påverkas.
4. När duschen inte används, stäng duschens omkopplingsventil.















SPARA DESSA INSTRUKTIONER

INSTALLATIONSINSTRUKTIONER

Modell	6002FL 8039FL 6012FL 8124FL 7009FL 7016FL 7002FL 7015FY							
Montering Typ	Väggfäste							
Förbindelse Tråd	G1/2"							
Funktioner	Fyra Lägen	Sex Lägen	Fem Lägen	Fem Lägen	Fem Lägen	Tre Lägen	Fyra Lägen	Fyra Lägen
Badkarspip	ÿ	ÿ	ÿ	ÿ	ÿ	x	ÿ	ÿ
Temperatur Visa	x	ÿ	x	x	ÿ	x	ÿ	x
LED-lampa	ÿ	ÿ	ÿ	ÿ	x	x	x	x
Driva	torr cell (DC3V)	torr cell (DC3V)	torr cell (DC3V)	torr cell (DC3V)	torr cell (DC3V)	x	torr cell (DC3V)	x
Hand Dusch	1-Setting	3-Setting	1-Setting	1-Setting	3-Setting	5-Setting	1-Setting	1-Setting
Avsluta	Duschsystem av borstat nickel utan fingeravtryck							Svart- Målning
Material	304 Rostfritt Stål, mässing, PVC, ABS		201 Rostfritt Stål, mässing, PVC, ABS		304 rostfritt stål, mässing, PVC, ABS			

DELLISTA

MODELL		8039FL	6002FL 6012FL 8124FL	7009FL 7016FL	7002FL	7015FY	
Handhållen Dusch	 eller 	1 st	1 st	1 st	1 st	1 st	1 st
1,5 meter Hand Spray Slang		1 st	1 st	1 st	1 st	1 st	1 st
Hand Spray säte		1 st	1 st	1 st	1 st	1 st	0 st
1/2 rätt Vinkel Adapter		2st	2st	2st	2st		2 st 2 st
4-punkts Gummi		2st	2st	2st	2st		2 st 2 st
Själv Tappning Skruva		4st	4st	4st	4st		4 st 4 st
Fästanordning		2st	2st	2st	2st		2 st 2 st
Grommet		1 st	1 st	1 st	1 st	1 st	2 st
Sexhörning Mutter		1 st	1 st	1 st	1 st	1 st	1 st

MODELL		8039FL	6002FL 6012FL 8124FL	7009FL	7016FL	7002FL	7015FY	
M6 Mutter		4st	4st	0st	0st	0st	0st	
M6*10 Skruva		4st	4st	0st	0st	0st	0st	
Slangklämma		2st	2st	0st	0st	0st	0st	
Mässing Duscharm		0st	0st	1st			1st	1st 0st
Panel Bomullsväska		1st	1st	1st	1st	1st	1st	
Top Spray Bomullsväska		1st	1st	0st	0st	0st	0st	
Batteri AA1,5V		2st	2st	2st	0st	2st	0st	
Rostfri Stål Vattentagg Ärm		0st	0st	0st	0st	0st		1 st
Hex i mässing Mutter		0st	0st	0st	0st	0st	1st	
Vattentagg Adapter		0st	0st	0st	0st	0st		1 st
Väggmonterad Spraybås		0st	0st	0st	0st	0st		1 st

MONTERINGSINSTRUKTIONER

MODELL 6012FL/6002FL/8039FL/8124FL



Sätt in PVC-röret från den övre öppningen för att sticka ut.



Dra LED-ljuskabeln längs hålsatsen i moderkortet.



Fixa moderkortet och toppsprayen med 4 par M6-skrivar och muttrar.

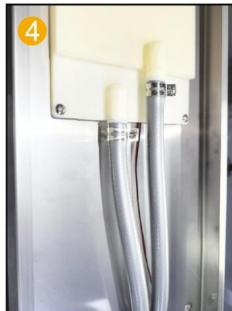

Fäst PVC-röret med en halsklämma på den övre sprayfogen.

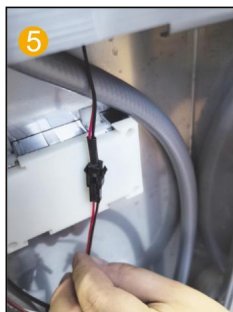

Anslut LED-ljuskabeln och strömförsörjningsledningens batterifacket.

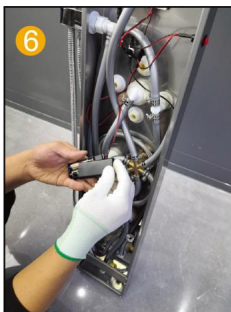

Sätt i 2 AA-batterier i

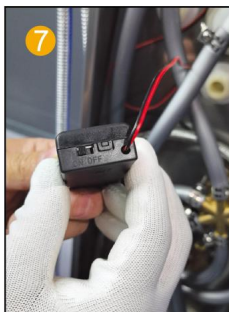

Slå på batterilådan.



Sätt in handspraymunstycket i panelen och installera packningen.

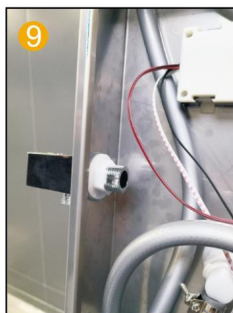

Sätt in handspraymunstycket i panelen och installera packningen.

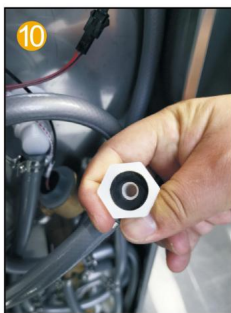

Sätt i 4-punkts gummit handsprayutloppsanslutningen och inuti skarven på handspraysätets ledsäte.

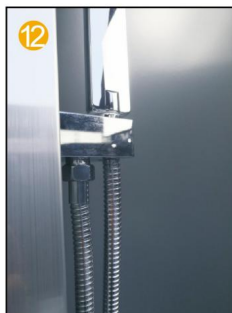
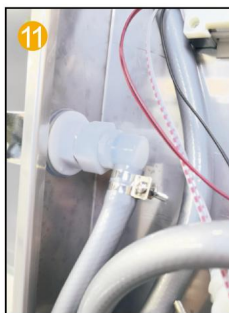

Anslut handsprayslangen till det handhållna duschhuvudet.

MODELL 7009FL/7016FL/7002FL



1 Fäst vattenutloppsarmen till huvudstyrelsen.



2 Anslut den övre sprayen och vattenutloppsarmen

gemensam.

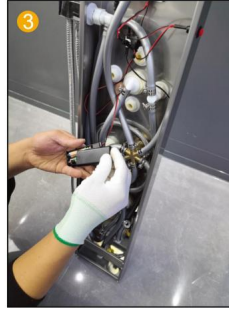

3 Sätt i 2 AA-batterier i batteriet avdelning.

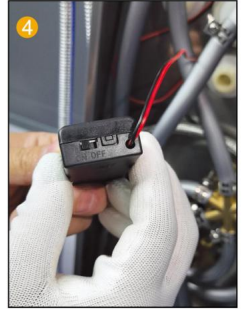

4 Byt batterilåda till PÅ.



5 Sätt in handspraymunstycket i panelen och installera packningen.

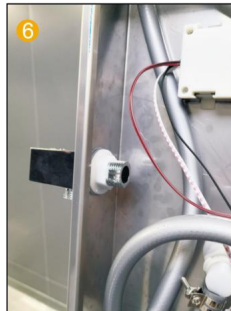

6 Sätt in handspraymunstycket i panelen och installera packningen.



7 Sätt på 4-vägsgummit in i kontakten på handspray säte.

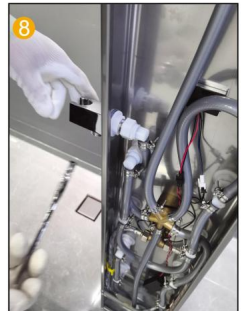

8 Anslut vattenutloppskontakten till handen spray säte kontakt.



9 Anslut den handhållna duschslang och handhållet duschhuvud.

Obs: 7016FL inga steg 3 och 4.

MODELL 7015FY



1 Fäst vattenutloppsarmen till huvudstyrelsen med muttrar och brickor.



2 Anslut den övre sprayen och vattenutloppsarmen

gemensam.



3 Anslut ståltråden röret och duscharmerna och dra åt den.

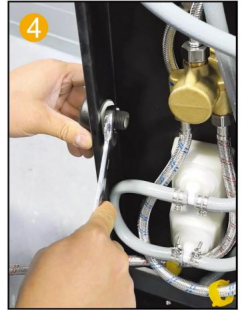

4 Fäst duschutloppsanslutningen till panelen med en mutter.



5 Sätt på 4-vägsgummit in i duschhuvudet kontakt.

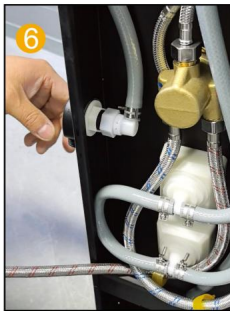

6 Anslut vattenutloppskontakten och duschmunstycke vattenuttag.



7 Fixa duschhuvudet fäste på väggen vid lämplig position med skruvar och muttrar.



8 Installation av duschhuvudsfäste färdigt.



9 Fäst panelen på väggen i lämplig höjd med fästet.



10 Anslut handenheten duschhuvud till slang.



11 Anslut till handhållet duschhuvud.



12 Installationen är klar.

INSTALLATIONSSTEG (ALLMÄNT)

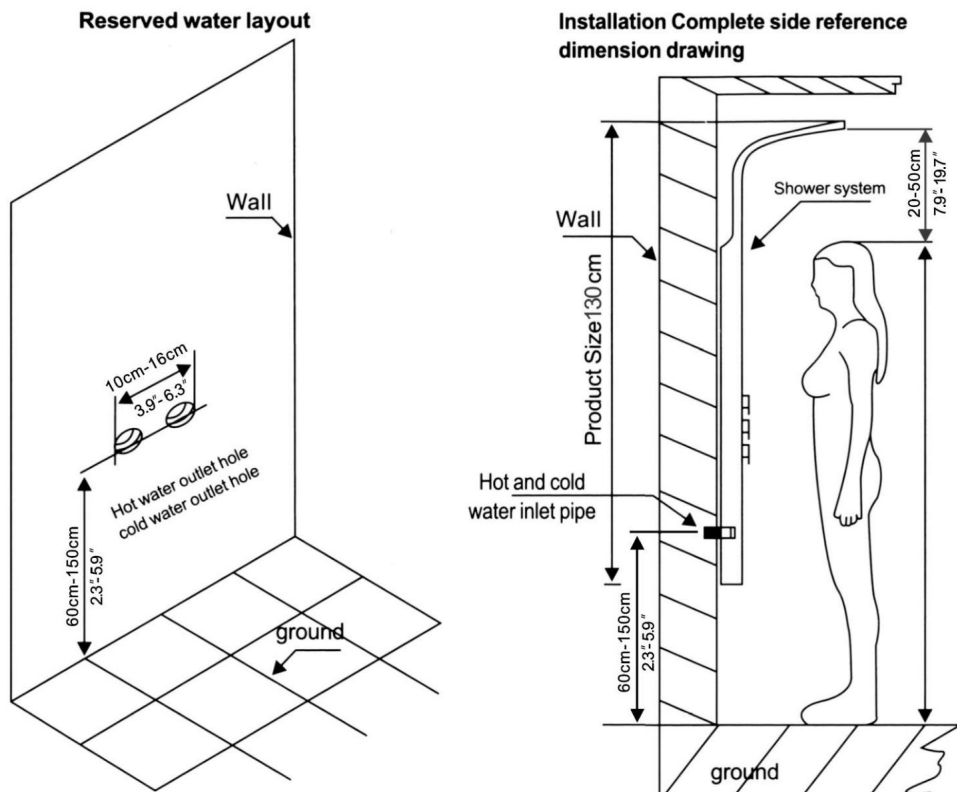

Installationsanmärkningar

1. Enligt höjden på familjens höjd budget duschsystem installationshöjd, mäta duschsystemet på baksidan av stängen Avstånd, markera på väggen, i motsvarande position av taggen fast hängande järn (upp och ner var och en).
2. Anslut varm- och kallvattenslangen (var noga med att rengöra magasinet och smutsen i väggen Våg för att inte blockera, påverka vattneffekten).
3. Duschsystem hängande på väggen, de övre och nedre två korten klämdes fast i två hängande pastor (Obs: dusch Efter systemväggen skakar inte huvudkroppen nära väggen, behöver inte använda ett annat glaslim och andra fixerade verktyg).

Underhållsmetoder för duschsystem i rostfritt stål:

1. Regelbunden rengöring av produkten för att hålla dess utseende ljukt och rena;
2. Rengör ytan med vatten eller ett mildt rengöringsmedel och torka av den med en mjuk handduk.
3. Observera att den rena produkten av den dolda positionen, snabb rengöring kan göra produkter som håller.

DUSHPANEL SERIE INSTALLATIONS DIAGRAM

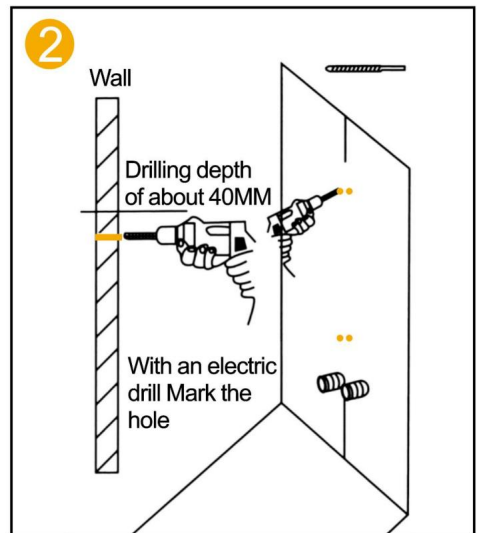
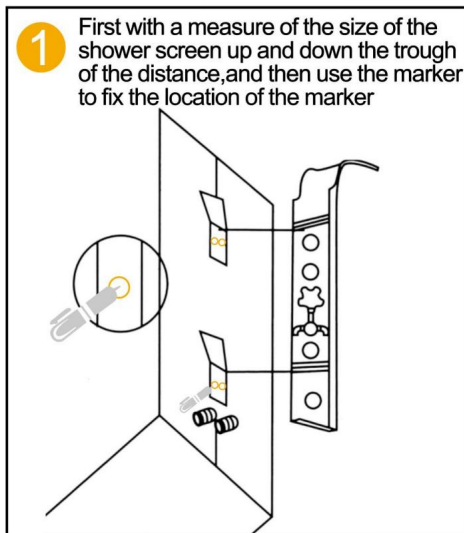

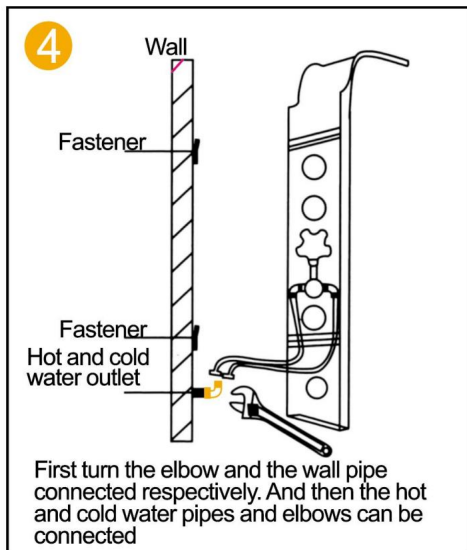
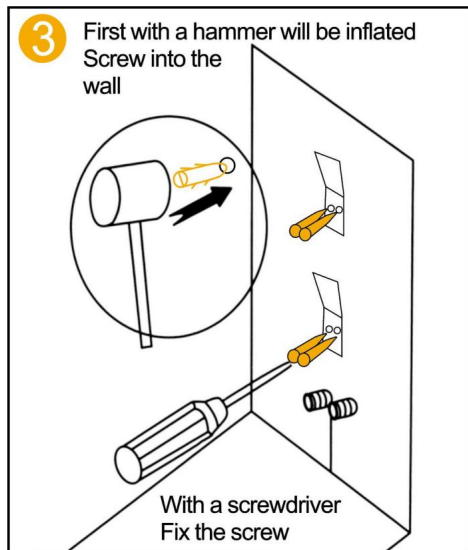

FUNKTION INTRODUKTION

6002FL / 6012FL



FUNKTION INTRODUKTION

8039FL

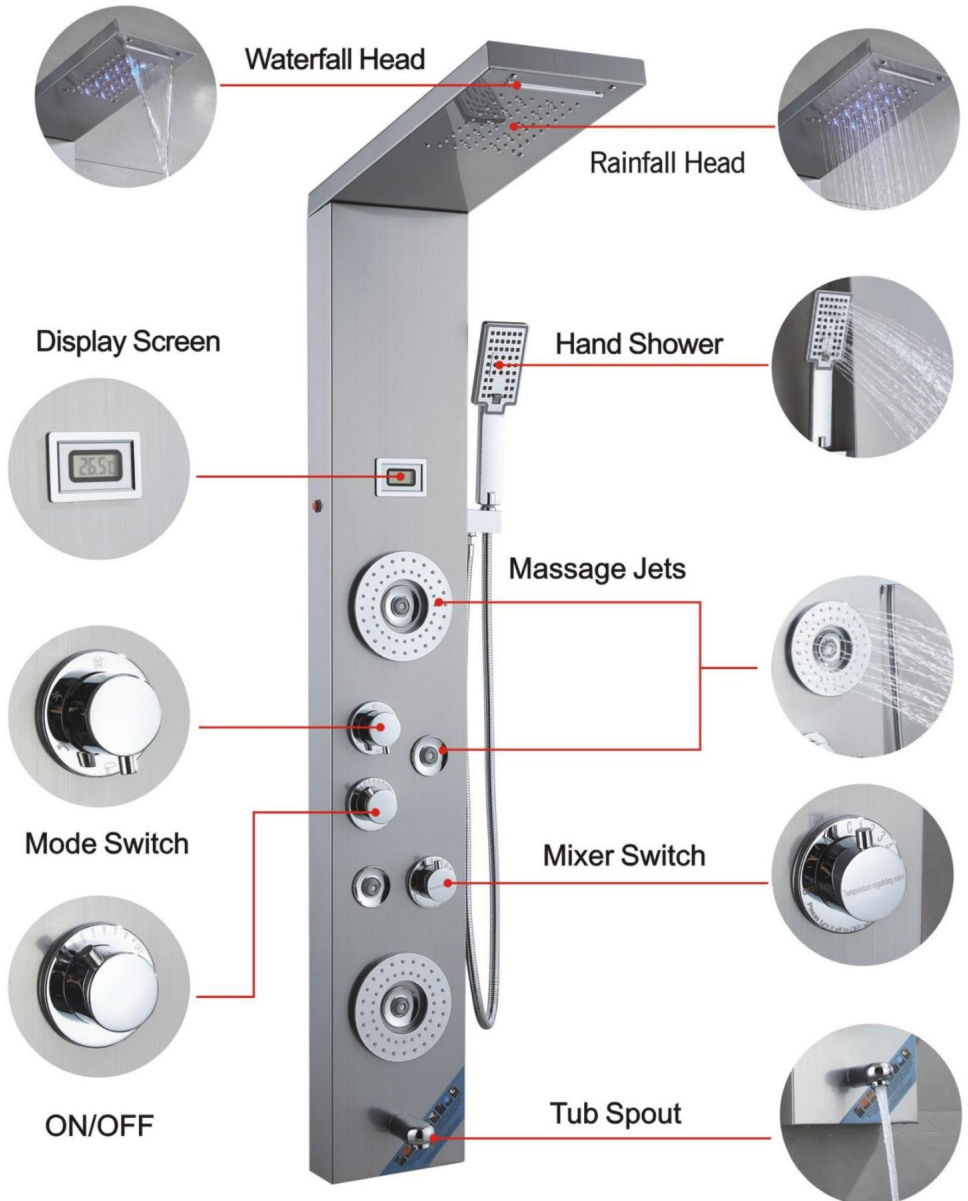

FUNKTION INTRODUKTION

7009FL

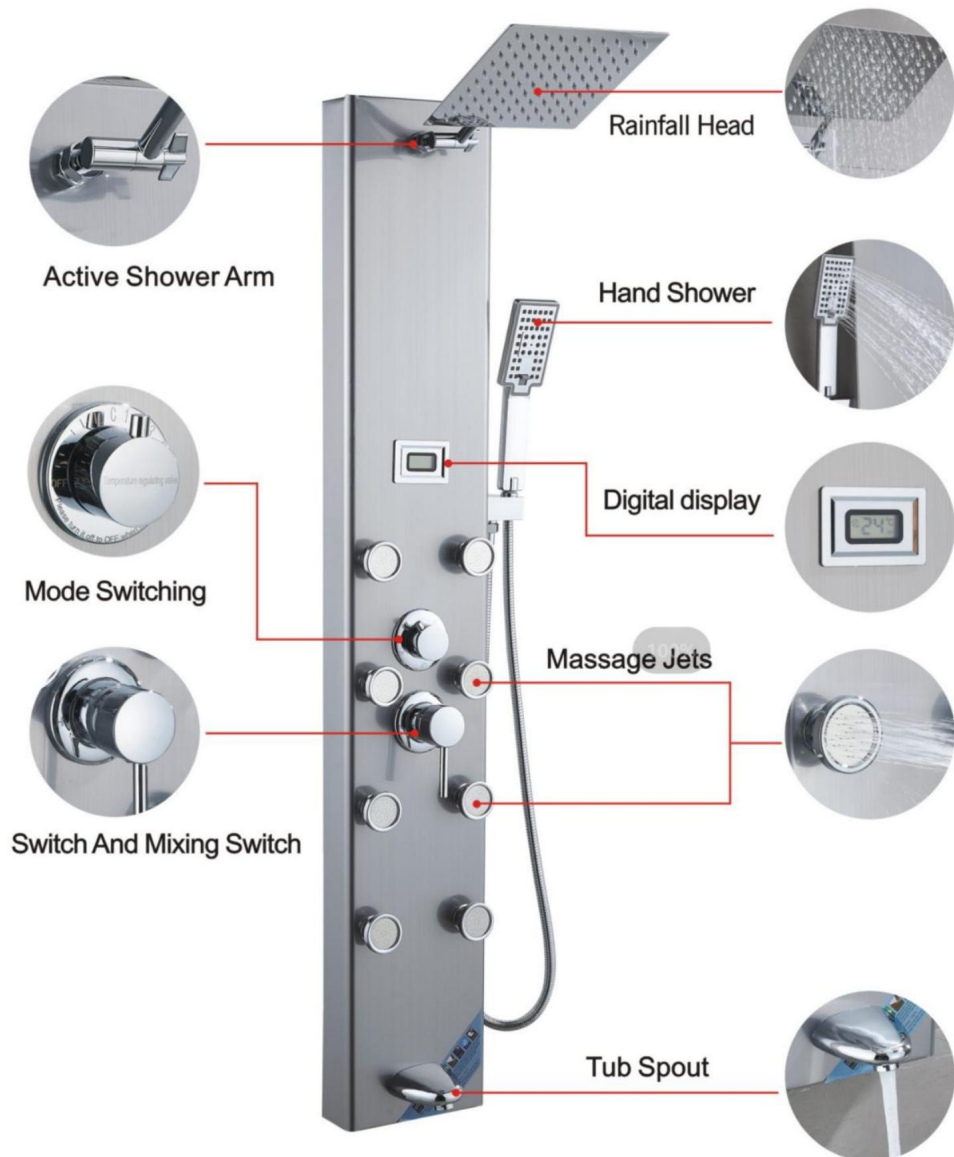

FUNKTION INTRODUKTION

8124FL



FUNKTION INTRODUKTION

7016FL

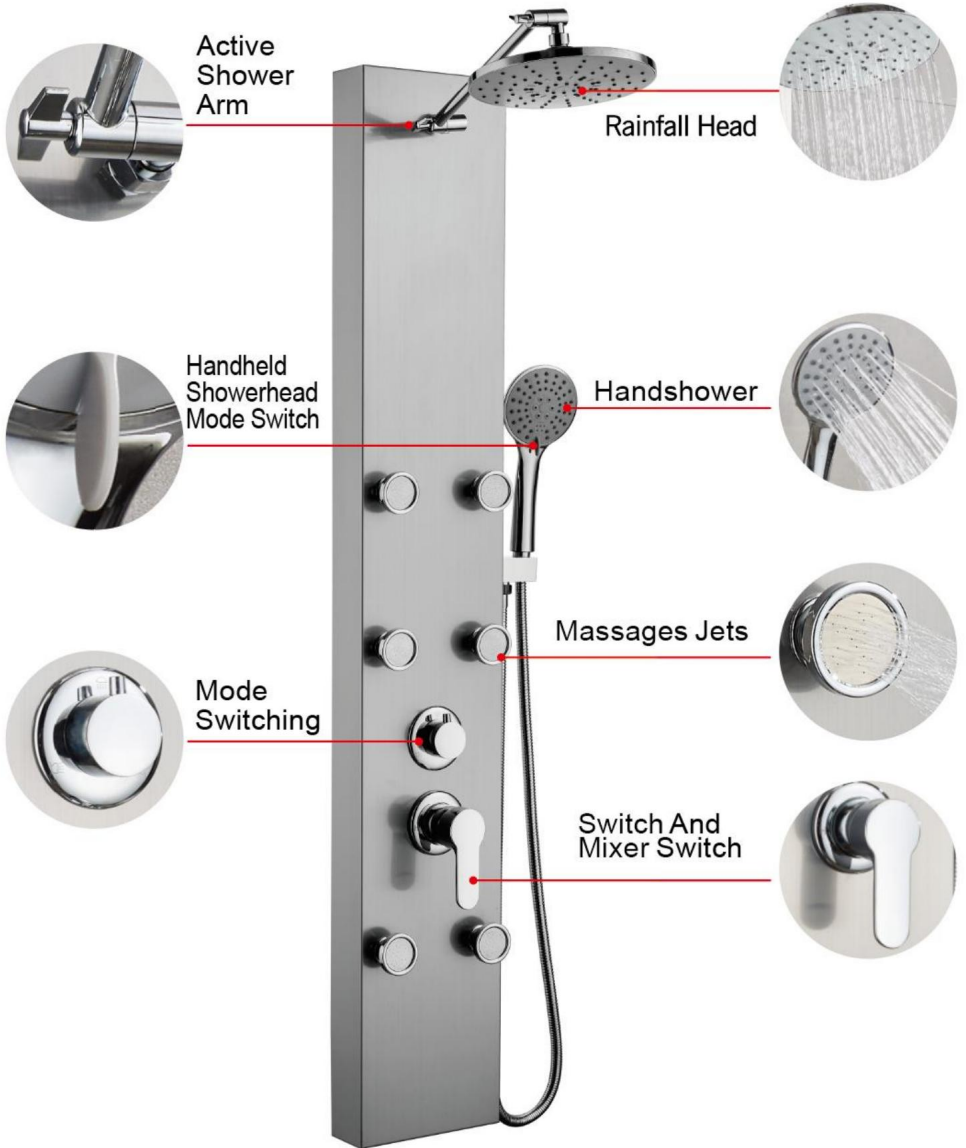

FUNKTION INTRODUKTION

7002FL

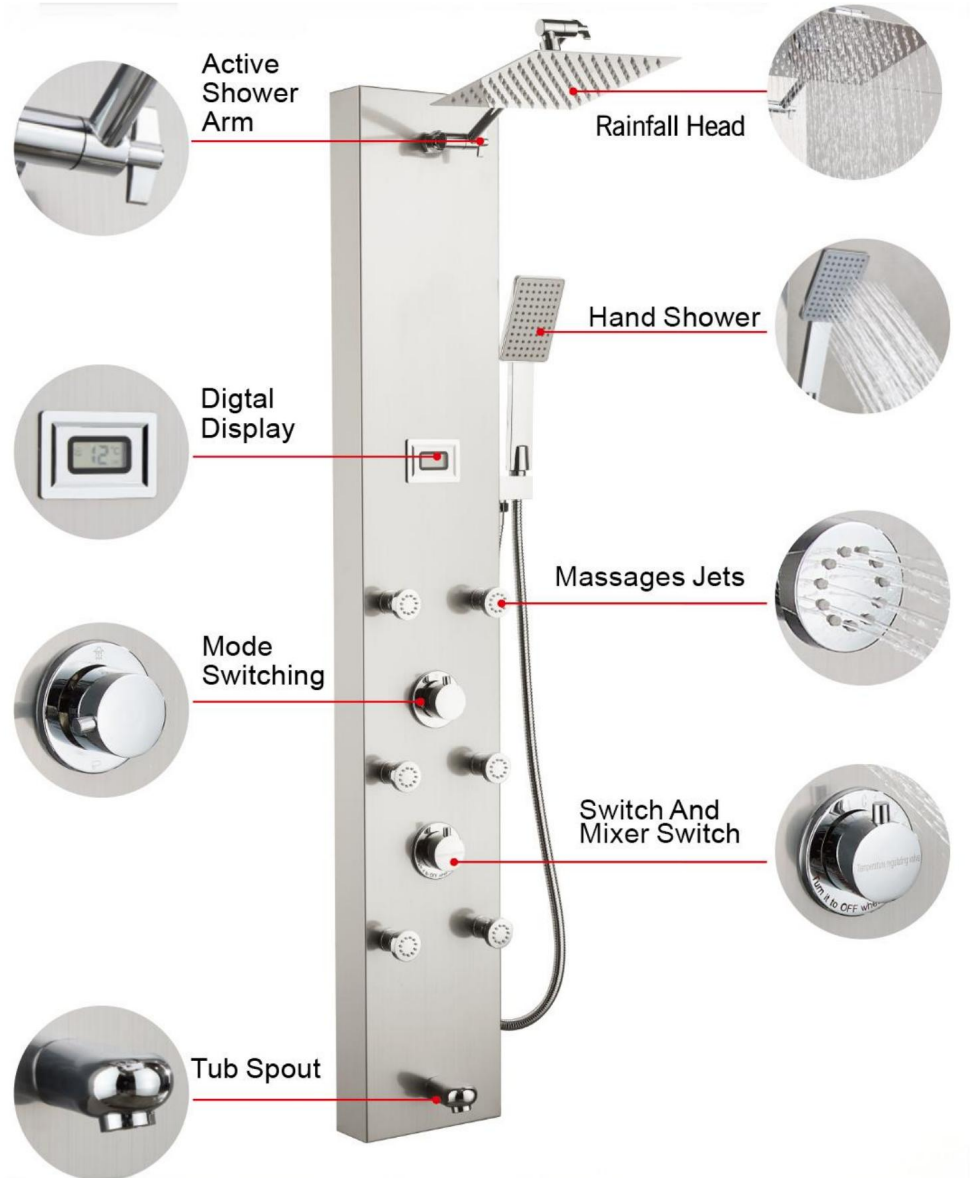

FUNKTION INTRODUKTION

7015FY



Obs: För den detaljerade installationsvideon, se motsvarande modell och skanna QR-koden nedan för att se.

6002FL / 6012FL



8039FL



8124FL



7009FL



7016FL



7002FL



7015FY



Teknisk support och e-garanticertifikat
www.vevor.com/support

VEVOR

Affordable. Reliable. Home Improvement.

DOUCHEPANEEL TOREN

MODEL:

6002FL, 8039FL, 7009FL, 6012FL, 8124FL, 7016FL, 7002FL, 7015FY

Technische ondersteuning en e-garantiecertificaat

www.vevor.com/support

VEVOR

DOUCHEPANEEL TOREN

Affordable. Reliable. Home Improvement.





6002FL

6012FL

8039FL 8124FL 7009FL 7016FL 7002FL 7015FY

Dit is de originele instructie, lees alle handleidingen zorgvuldig door voordat u het product gebruikt. VEVOR behoudt zich een duidelijke interpretatie van onze gebruikershandleiding voor. Het uiterlijk van het product is afhankelijk van het product dat u hebt ontvangen. Vergeef ons dat we u niet opnieuw zullen informeren als er technologie- of software-updates voor ons product zijn.

	<p>Waarschuwing - Om het risico op letsel te verminderen, moet de gebruiker de volgende informatie lezen:</p> <p>Lees de gebruiksaanwijzing zorgvuldig door.</p>
	<p>Dit apparaat voldoet aan Deel 15 van de FCC-regels. De bediening is onder de volgende twee voorwaarden: (1) Dit apparaat mag geen schadelijke interferentie, en (2) dit apparaat moet elke interferentie accepteren ontvangen, met inbegrip van storingen die een ongewenste werking kunnen veroorzaken.</p>
	<p>Dit product is onderworpen aan de bepalingen van de Europese richtlijn 2012/19/EG. Het symbool met een kliko-afvalbak doorkruist geeft aan dat het product gescheiden afvalinzameling vereist in de Europese Unie. Dit geldt voor het product en alle accessoires gemarkeerd met dit symbool. Producten die als zodanig gemarkeerd zijn, mogen niet weggegooid met het normale huisvuil, maar moet naar een afvalverwerkingsbedrijf worden gebracht.</p> <p>inzamelpunt voor het recyclen van elektrische en elektronische apparaten</p>

INSTRUCTIES

Waarschuwingstips:

1. Tijdens het installatieproces is het het beste om handschoenen te dragen om scherpe voorwerpen te voorkomen. hoeken van het paneel tegen krassen op de handpalm.
2. Zorg er bij het installeren van de douche voor dat alle verbindingen volledig zijn vastgedraaid om waterlekage te voorkomen.
3. Zorg ervoor dat de rode en blauwe waterinlaatleidingen in het paneel niet in een opgevouwen toestand om te voorkomen dat de waterdruk wordt beïnvloed.
4. Wanneer de douche niet in gebruik is, sluit u de hoofdkraan van de douche.























BEWAAR DEZE INSTRUCTIES

INSTALLATIE-INSTRUCTIES

Model	6002FL 8039FL 6012FL 8124FL 7009FL 7016FL 7002FL 7015FY							
Montage Type	Muurbevestiging							
Verbinding Draad	G1/2"							
Funcities	Vier Modi	Zes Modi	Vijf Modi	Vijf Modi	Vijf Modi	Drie Modi	Vier Modi	Vier Modi
Baduitloop	ÿ	ÿ	ÿ	ÿ	ÿ	x	ÿ	ÿ
Temperatuur Weergave	x	ÿ	x	x	ÿ	x	ÿ	x
LED-lamp	ÿ	ÿ	ÿ	ÿ	x	x	x	x
Stroom	Droge cel <small>(3V gelijkstroom)</small>	Droge cel <small>(3V gelijkstroom)</small>	Droge cel <small>(3V gelijkstroom)</small>	Droge cel <small>(3V gelijkstroom)</small>	Droge cel <small>(3V gelijkstroom)</small>	x	Droge cel <small>(3V gelijkstroom)</small>	x
Hand Douche	1-Instelling	3-Instelling	1-Instelling	1-Instelling	3-Instelling	5-Instelling	1-Instelling	1-Instelling
Finish	Vingerafdrukrij geborsteld nikkel douchesysteem							Zwart- Schilderen
Materiaal	304 roestvrij staal Staal, Messing, PVC, ABS		201 roestvrij staal Staal, Messing, PVC, ABS		304 roestvrij staal, messing, PVC, ABS			

ONDERDELENLIJST

MODEL		8039FL	6002FL 6012FL 8124FL	7009FL 7016FL	7002FL	7015FY	
Draagbaar Douche	 of	1 stuks	1 stuks	1 stuks	1 stuks	1 stuks	1 stuks
1,5 meter Hand Spuiten Slang		1 stuks	1 stuks	1 stuks	1 stuks	1 stuks	1 stuks
Hand Spuitstoel		1 stuks	1 stuks	1 stuks	1 stuks	1 stuks	0 stuks
1/2 Rechts Hoek Adapter		2 stuks	2 stuks	2 stuks	2 stuks	2 stuks	2 stuks
4-punts Rubber		2 stuks	2 stuks	2 stuks	2 stuks	2 stuks	2 stuks
Zelf Tikken Schroef		4 stuks	4 stuks	4 stuks	4 stuks	4 stuks	4 stuks
Bevestigingsmiddel		2 stuks	2 stuks	2 stuks	2 stuks	2 stuks	2 stuks
Ringetje		1 stuks	1 stuks	1 stuks	1 stuks	1 stuks	2 stuks
Zeshoek Moer		1 stuks	1 stuks	1 stuks	1 stuks	1 stuks	1 stuks

MODEL		8039FL	6002FL 6012FL 8124FL	7009FL 7016FL	7002FL	7015FY	
M6 moer		4 stuks	4 stuks	0 stuks	0 stuks	0 stuks	0 stuks
M6*10 Schroef		4 stuks	4 stuks	0 stuks	0 stuks	0 stuks	0 stuks
Slangklem		2 stuks	2 stuks	0 stuks	0 stuks	0 stuks	0 stuks
Messing Douche arm		0 stuks	0 stuks	1 stuks	1st	1st	0st
Paneel Katoenen tas		1st	1st	1st	1st	1st	1st
Bovenste sproeier Katoenen tas		1st	1st	0st	0st	0st	0st
Batterij AA1.5V		2 stuks	2 stuks	2 stuks	0 stuks	2 stuks	0 stuks
Roestvrij Staal Waterafvoer Arm		0st	0st	0st	0st	0st	1 stuks
Messing zeskant Moer		0st	0st	0st	0st	0st	1st
Waterafvoer Adapter		0st	0st	0st	0st	0st	1 stuks
Aan de muur bevestigd Spuitscabine		0st	0st	0st	0st	0st	1 stuks

MONTAGE-INSTRUCTIES

MODEL 6012FL/6002FL/8039FL/8124FL



1 Steek de PVC-buis door de bovenste opening naar binnen.



2 Leid de LED-lichtdraad langs het gat in het moederbord.



3 Bevestig het moederbord en de bovenste spuitbus met 4 paar M6-schroeven en moeren.

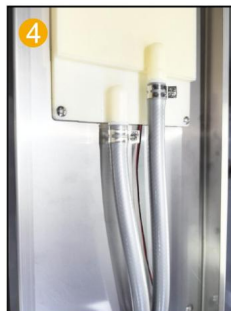

4 Bevestig de PVC-buis met een klem aan de bovenste spuitverbinding.

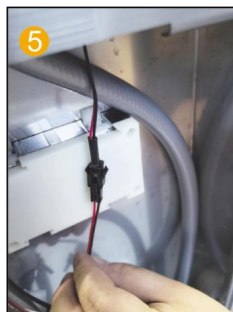

5 Sluit de LED-lichtkabel en de stroomtoevoer aan.

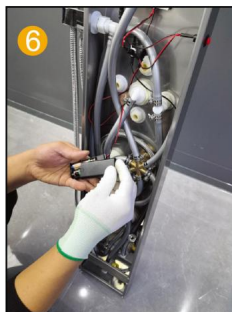

6 Plaats 2 AA-batterijen in het batterijvak.

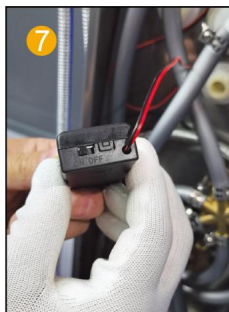

7 Zet de batterijdoos op AAN.



8 Plaats de handsproeikop in het paneel en monteer de pakking.

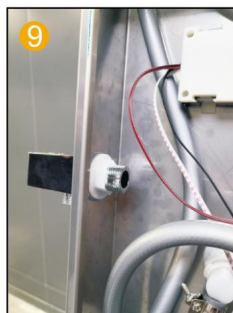

9 Plaats de handsproeikop in het paneel en monteer de pakking.

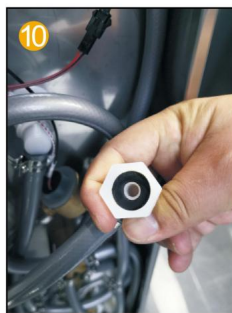

10 Plaats de 4-punts rubberen aansluiting voor het water in de aansluiting van de handsproeieruitlaat en in de aansluiting van de zitting van de handsproeierzitting.

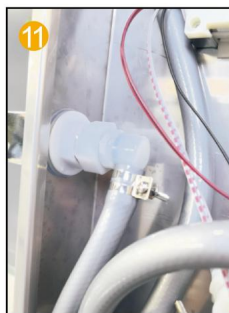

12 Sluit de handdoucheslang aan op de handdouche.

MODEL 7009FL/7016FL/7002FL



1
Bevestig de wateruitlaatarm naar het moederbord.



2
Sluit de bovenste sproeier en de wateruitlaatarm aan gewicht.

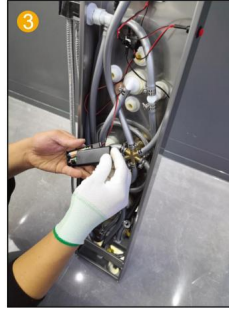

3
Plaats 2 AA-batterijen in de batterij compartiment.

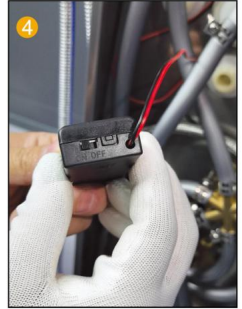

4
Schakel de batterijdoos om naar AAN.



5
Plaats de handsproeikop in het paneel en monteer de pakking.



6
Plaats de handsproeikop in het paneel en monteer de pakking.



7
Plaats de 4-weg rubber in de connector van de handsproeier stoel.

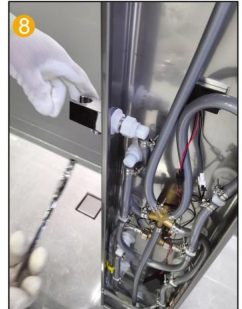

8
Sluit de wateruitlaatconnector aan op de hand sproeierzitting connector.



9
Sluit de handbediende doucheslang en de handdouchekop.

Let op: 7016FL geen stap 3 en 4.

MODEL 7015FY



1
Bevestig de wateruitlaatarm naar het hoofdbord met moeren en ringen.

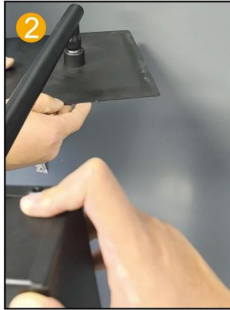

2
Sluit de bovenste sproeier en de wateruitlaatarm aan gewicht.



3
Sluit de staaldraad aan buis en de douchearm en draai deze vast.

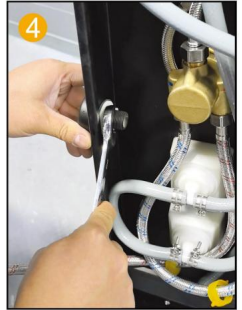

4
Bevestig de douche-uitlaataansluiting met een moer aan het paneel.



5
Plaats de 4-weg rubber in de douche- kop verbindingstuk.

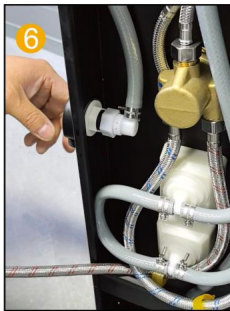

6
Sluit de wateruitlaatconnector en de Aansluiting voor waterafvoer douche- kop.



7
De douche- kop repareren beugel aan de muur bij de geschikte positie met schroeven en moeren.



8
Installatie van de Douche- kophouder is voltooid.



9
Bevestig het paneel op de gewenste hoogte met de beugel aan de muur.



10
Sluit de handheld aan douche- kop naar de slang.



11
Maak verbinding met de handdouchekop.



12
Installatie voltooid.

INSTALLATIESTAPPEN (ALGEMEEN)

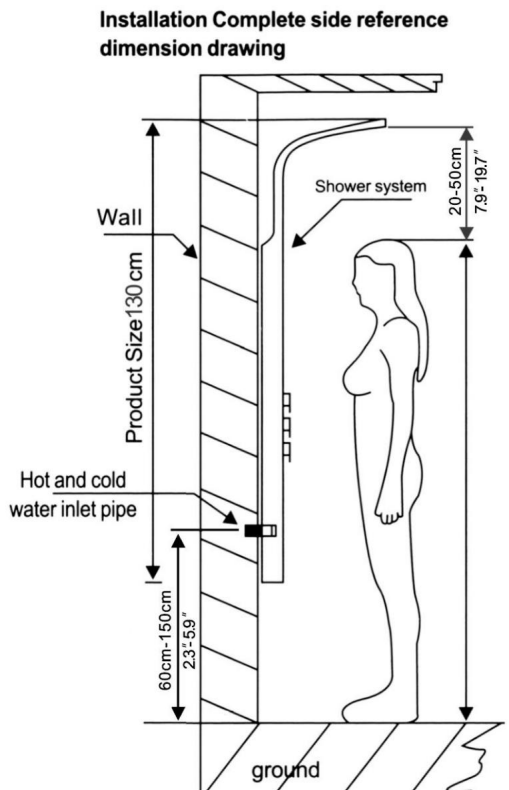
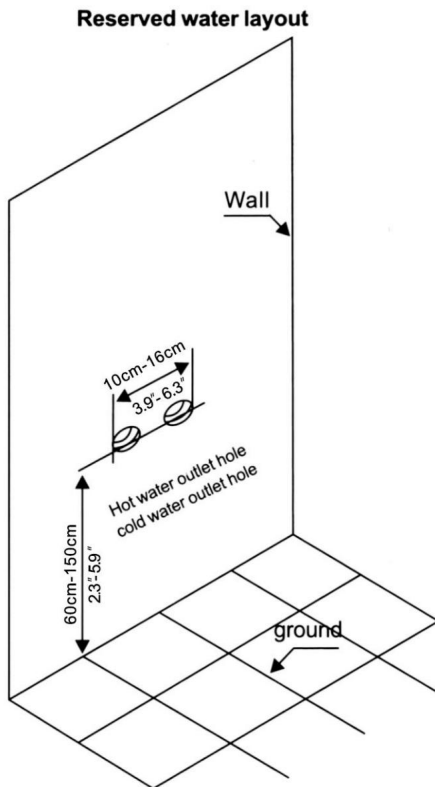

Installatie-opmerkingen

1. Meet, afhankelijk van de hoogte van het gezinsbudget voor de installatie van het douchesysteem, de afstand van het douchesysteem op de achterkant van de stang, markeer deze op de muur, in de overeenkomstige positie van het label dat het strijkijzer ophangt (elk omhoog en omlaag).
2. Sluit de warm- en koudwaterslang aan (zorg ervoor dat u het magazijn en het vuil in de muur schoonmaakt om verstoppingen te voorkomen die het watereffect beïnvloeden).
3. Douchesysteem aan de muur hangen, de bovenste en onderste twee kaarten zijn vastgeklemd in twee ophangpasta's (Let op: douchesysteem Na de wand van het systeem schudt het hoofdgedeelte dicht bij de muur niet, hoeft u geen andere glaslijm en andere gereedschappen te gebruiken om het vast te zetten).

Onderhoudsmethoden voor roestvrijstalen douchesystemen:

1. Regelmatige reiniging van het product om het uiterlijk ervan helder en mooi te houden schoon;
2. Maak het oppervlak schoon met water of een mild schoonmaakmiddel en veeg het af met een zachte handdoek.
3. Houd er rekening mee dat het schone product van de verborgen positie, tijdige reiniging kan maken producten die lang meegaan.

INSTALLATIEDIAGRAM DOUCHEPANEELSERIE

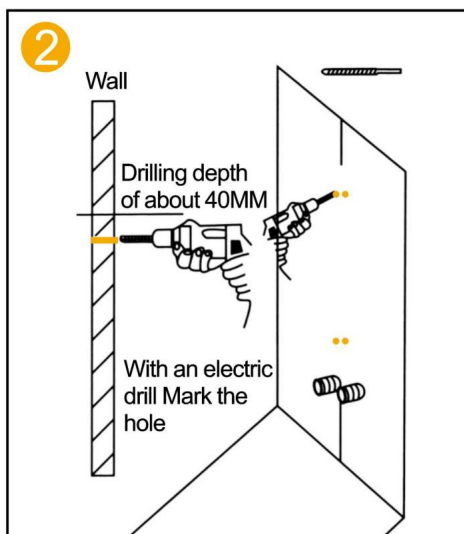
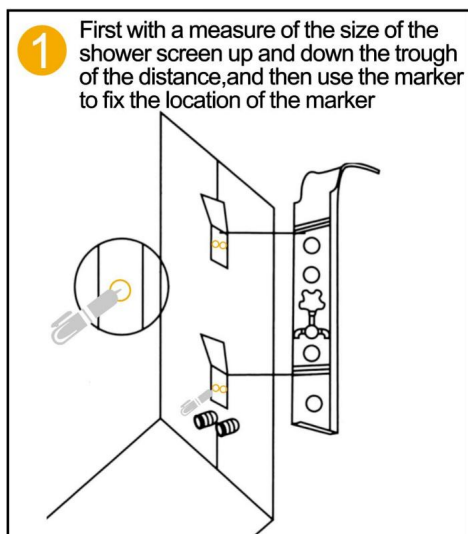

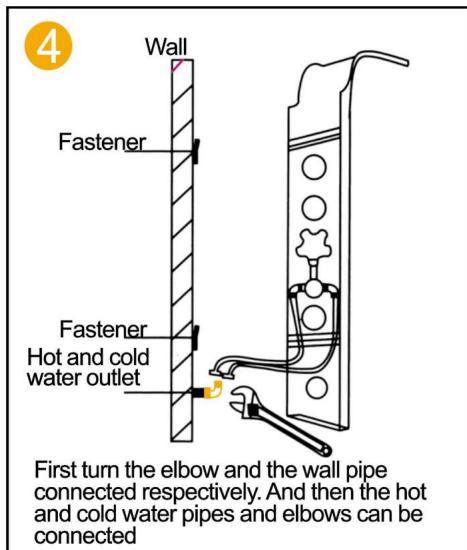
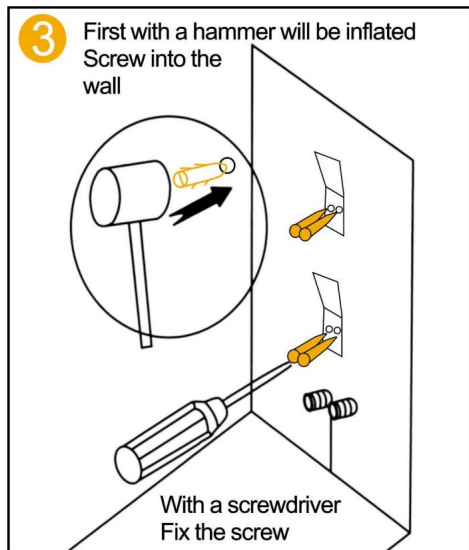

FUNCTIE INLEIDING

6002FL / 6012FL



FUNCTIE INLEIDING

8039FL

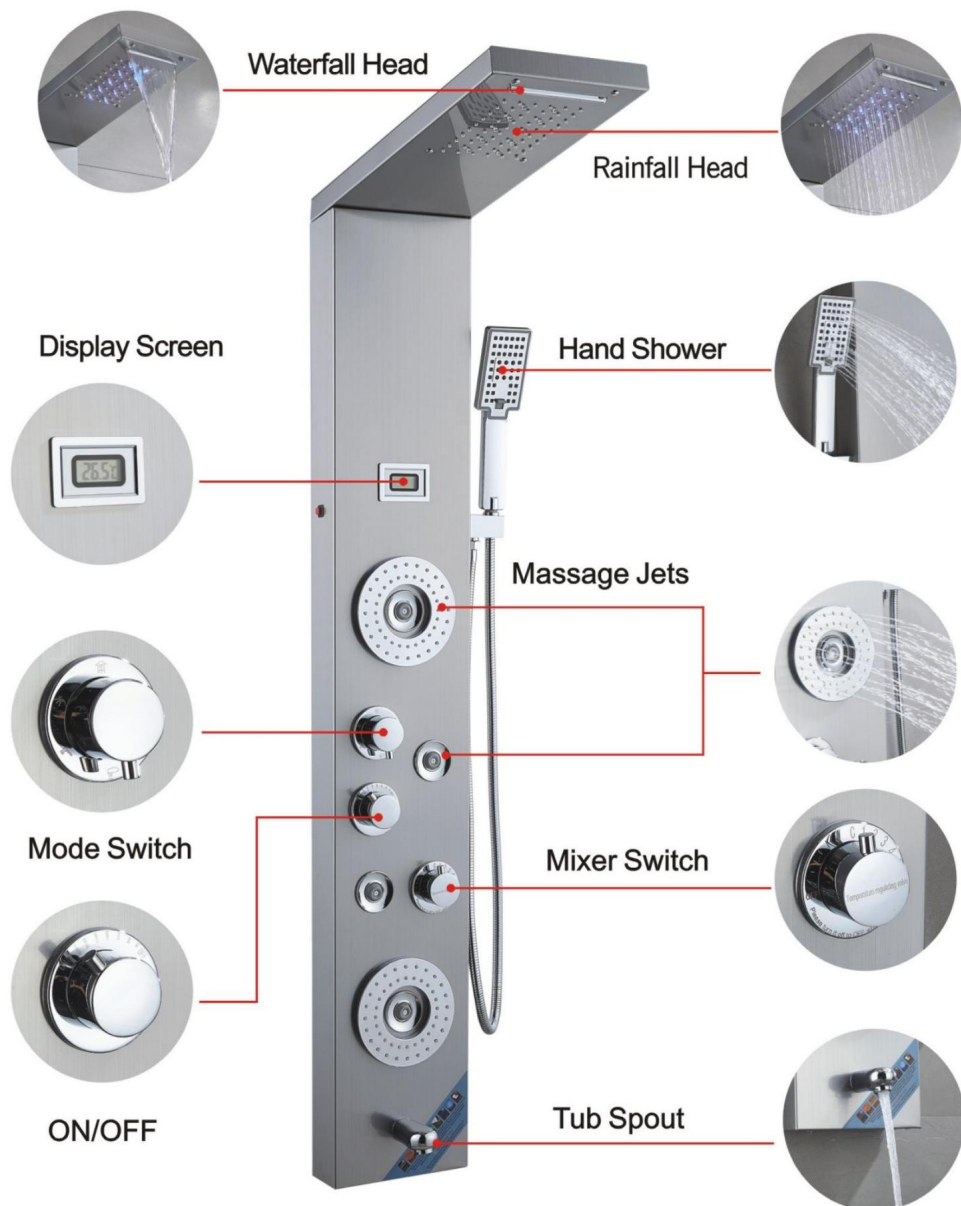

FUNCTIE INLEIDING

7009FL

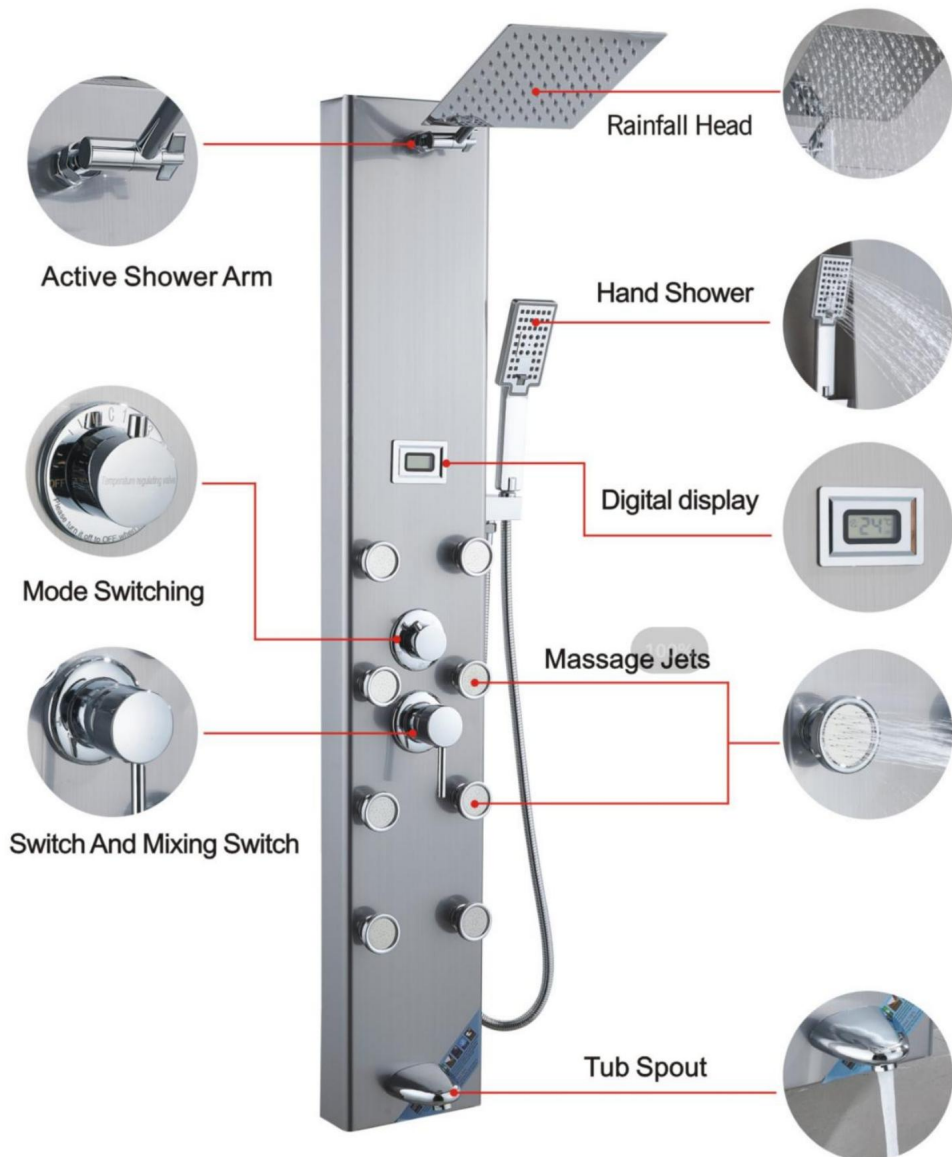

FUNCTIE INLEIDING

8124FL



FUNCTIE INLEIDING

7016FL

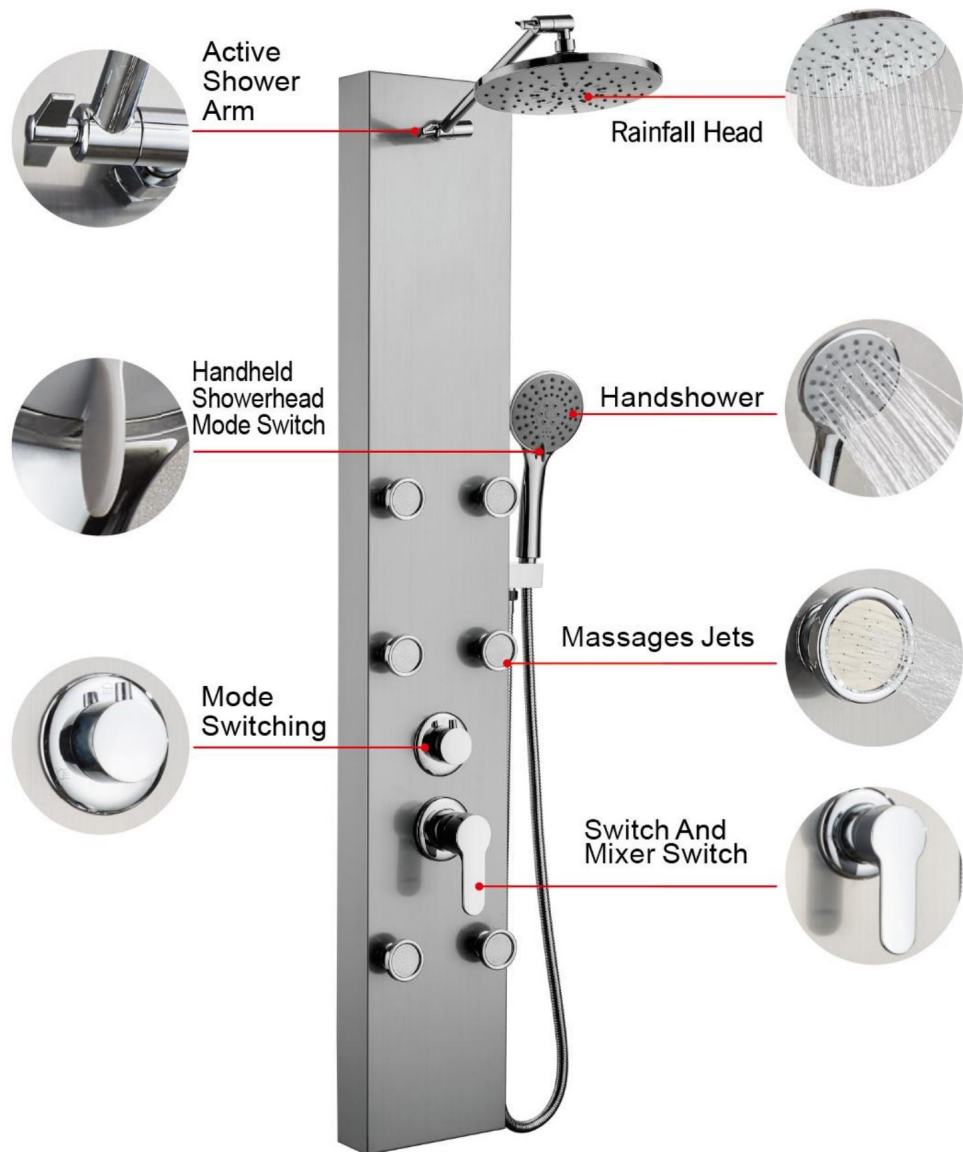

FUNCTIE INLEIDING

7002FL

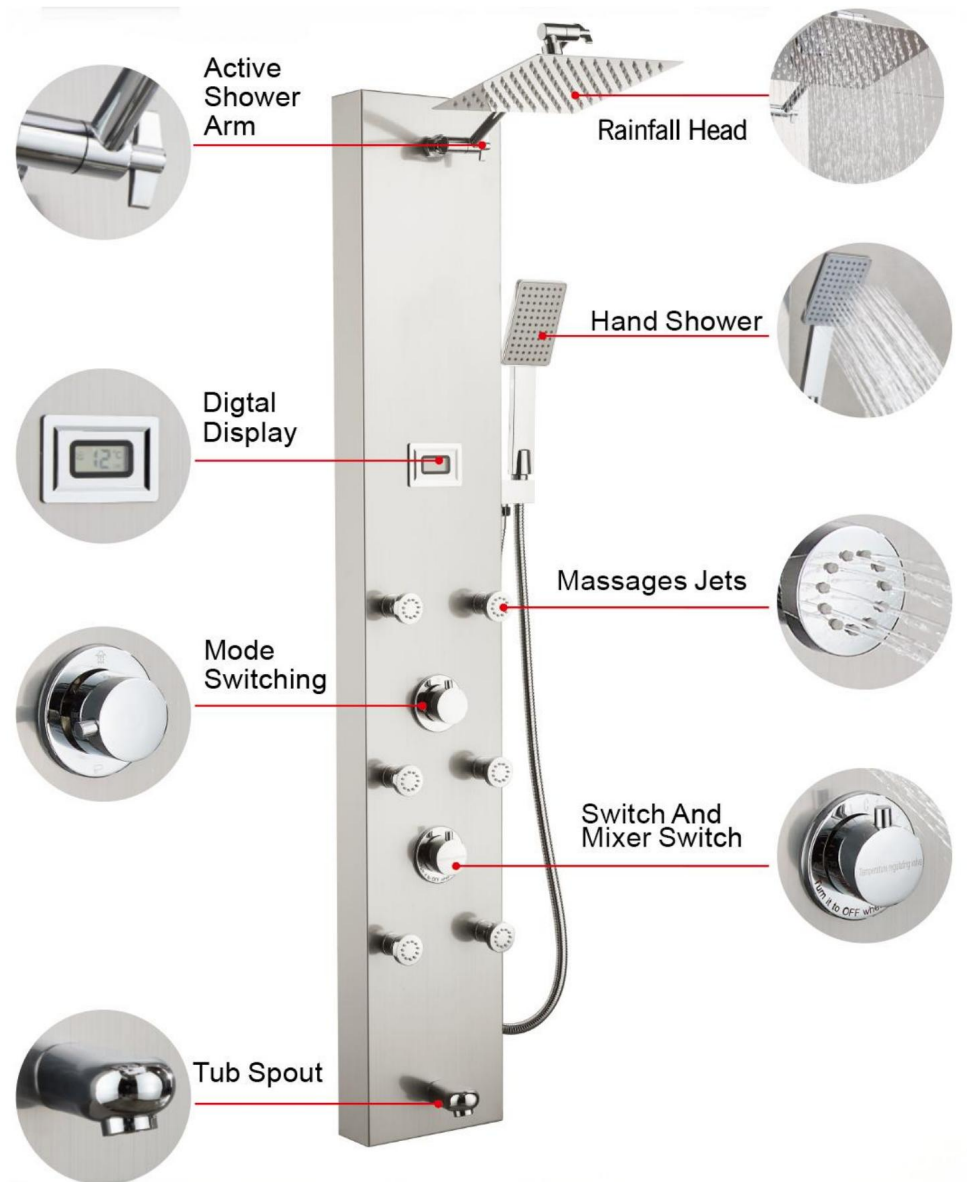

FUNCTIE INLEIDING

7015FJ

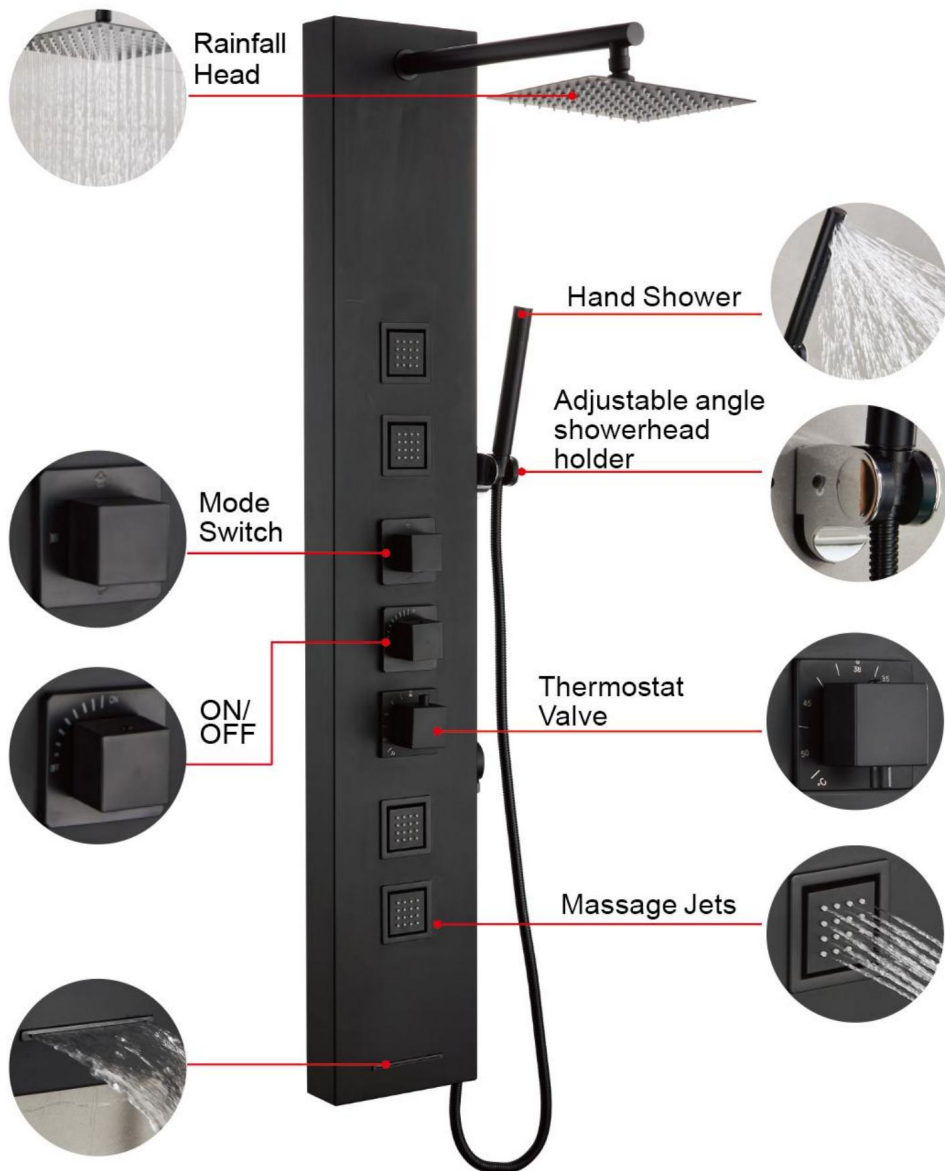

Let op: voor **de gedetailleerde installatievideo** verwijzen wij u naar de **overeenkomstig model en scan de onderstaande QR-code om te bekijken.**

6002FL / 6012FL



8039FL



8124FL



7009FL



7016FL



7002FL



7015FJ



Technische ondersteuning en e-garantiecertificaat
www.vevor.com/support