

# Freestanding Cookers Operating & Installation Manual



# YOUR FREE MASTERCLASS

Although we encourage you to dive right in, as the owner of a brand new ILVE oven we'd also like to invite you to attend a complimentary 2 hour masterclass. As part of the class you'll learn how to prepare and cook a number of delicious signature ILVE dishes, not to mention our top tips for getting the most out of your ILVE oven. From improving cooking results to general maintenance information, we know you'll enjoy this comprehensive, fun masterclass.

Simply go to [ilve.com.au/bookings](http://ilve.com.au/bookings) or Phone 1300 MY ILVE (694 583)







OPEN 24/7  
ILVE ACCESSORIES ONLINE SHOP

For a wide range of coffee machines, pods, and other ILVE accessories at the click of a button [shop.ilve.com.au](http://shop.ilve.com.au)

As a part of our continued customer service offering, you can now register your ILVE products online at [warranty.ilve.com.au/registration](http://warranty.ilve.com.au/registration)

Just follow our simple online registration process.

Please ensure that you always keep your proof of purchase in order for your warranty to remain valid should you ever need to use it.

As always, you can contact us on  
1300 MY ILVE (694 583)



# iWarranty

REGISTER YOUR WARRANTY ONLINE NOW

GO TO: [warranty.ilve.com.au/registration](http://warranty.ilve.com.au/registration)

## Congratulations,

you are now the proud owner of an ILVE cooking appliance. Thank you for purchasing ILVE and welcome to the exciting world of cooking the ILVE way.

This instruction manual has been specially created to inform you of the full range of features your ILVE appliance has to offer and serves as an introduction to the wonderful benefits of ILVE's dynamic cooking systems.

We present detailed information on each of the advanced cooking systems built into ILVE appliances. Once you have read this section you will be able to choose the most appropriate settings for your appliance when cooking different types of food.

We ask you to read the instructions in this booklet very carefully as this will allow you to get the best results from using your appliance. **KEEP THE DOCUMENTATION OF THIS PRODUCT FOR FUTURE REFERENCE.**



# CONTENTS

Safety Precautions	10	Cleaning, Care and Maintenance	32
Operating Instructions	11	Installation Instructions	36
Oven Systems	12	Electrical Connection	41
Clock and Timer Controls	13	Adaptation to Different Types of Gas	42
Electric Oven Cooking Modes	14	Injector & Capacity Table	43
Grill Systems	16	Air Adjustment	44
Using the Rotisserie	18	Low Flame Adjustment of Burners	45
Operating - Gas Cooktop	20	Low Flame Adjustment of Burners	46
Tepanyaki plate	22	Ancillary Service Information	47
Simmer plate	24	Recipes	48
Electric BBQ	25	Guarantee	60
Ceramic Electric Hot Plate	26	Warranty Information	58
Induction and Induction Tepanyaki cooktop	28	Trouble Shooting Guide	64
Gas Ovens	30		

# SAFETY PRECAUTIONS

Before installing and operating the cooking range, read these instructions completely and carefully.

## IMPORTANT:

- To be installed only by an authorised person
- Save these instructions for the local inspector's use.
- Remove all packaging material and literature from the appliance before connecting the gas and electrical supplies. Additionally note that the correct wok trivet must be placed over the wok burner. The wok burner trivet has a greater gap between the fingers.
- Observe all governing codes e.g. AS/NZS 5601, council ordinances and local authority rules. - The range must be electrically grounded

**TO THE INSTALLER** – after connecting the gas supply, turn on the gas and check for leaks at all joints with soapy water or other approved methods **UNDER NO CIRCUMSTANCES USE A NAKED FLAME IN CHECKING FOR LEAKS. NOT FOR USE IN MARINE CRAFT, CARAVANS OR MOBILE HOME UNLESS EACH BURNERS IS FITTED WITH A FLAME SAFE GUARD**

## WARNINGS

Before using the cooker, read the instructions booklet carefully. This contains very important information concerning safety during installation, use and maintenance. The instructions booklet must be kept with care for later consultation.

Do not use or store flammable materials in the appliance storage drawer or near this appliance.

Do not spray aerosols in the vicinity of this appliance when it is in operation.

Where this appliance is installed in a marine craft or in caravans, it shall not be used as a space heater.

Do not modify this appliance.

If the hotplate fails to operate correctly, contact Eurolinx Pty Ltd or their appointed agent for service.

**DO NOT ATTEMPT REPAIRS YOURSELF;** repairs and servicing shall only be carried out by Authorised Personnel.

This appliance is not intended for use by persons (including children) with reduced physical, sensory or mental capabilities, or lack of experience and knowledge, unless they have been given supervision or instruction concerning use of the appliance by a person responsible for their safety.

Children should be supervised to ensure that they do not play with the appliance.

Never place unsteady or deformed pans on the burners or on the electric hotplates as they could overturn accidentally. When placing pans on the hob, always ensure that the handles are facing inward so that there is no risk of knocking against them.

When the cooker is not in use, ensure that all knobs are exactly in position “o / o”

Never leave the hotplate switched on without a pan on it, otherwise it will reach a very high temperature quickly and the cooker or furniture in the vicinity could be damaged.

ILVE stoves, wall ovens and cooktops feature many advanced cooking components and safety refinements. However before using your oven for the first time the following installation check must be carefully carried out and oven elements must be burnt in.

- Check that your ILVE installer has screwed the oven into its cavity and that all packaging is removed from inside oven.
- Check that all oven racks are in place.

## Rack positions

ILVE ovens are equipped with various racks depending on the model and size; all ILVE wire racks are reversible. They have angled offset ends to allow for height variation between shelves; this is a particularly useful feature when cooking with deep dishes, for large roasts or when batch cooking.

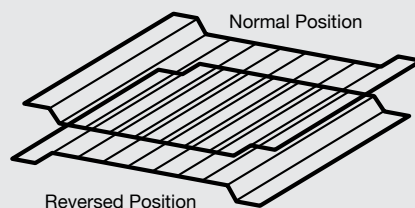

## Burning in elements

It is necessary to burn the protective oils that are used in manufacturing and shipping from the elements.

- 1 Set the clock to the correct time.
  - 2 Set oven temperature control knob to 200° C and select cooking function mode 2 by turning function control knob.
  - 3 Allow to burn in for 10 to 15 minutes.
  - 4 Repeat process for functions 5 and 8 in sequence and allow to burn in each mode for 10 to 15 minutes.
  - 5 Clean the oven thoroughly when you have completed the burn in process so that the oven and grill/roisserie will be ready for use.
- There may be a slight unpleasant odour during the initial burn off procedure. As a result we advise you open doors and windows in the kitchen during this procedure.

## Preparing your electric oven for use:

### Setting the clock

To enable use of your ILVE oven you must first set the clock to the correct time. If the clock is not set correctly the oven will not operate.

### Using the oven

When using your ILVE oven you must select, using separate knobs, both a mode of cooking and a temperature at which to cook. The only exception to this rule is when using the defrost mode, where no temperature setting is required.

Temperature is indicated by an ORANGE light. This light will turn on and off during cooking as the thermostat readjusts itself.

Cooking mode selection is indicated by a GREEN light. This light should stay on throughout the cooking process. All ILVE ovens are fitted with a cavity cooling fan. This fan is thermostatically controlled and automatically switches on when the oven cavity reaches 60°C. This gently blows air out through the front louvre just above the oven door handle, reducing outside heat.

### Temperature

ILVE ovens are well insulated and therefore highly efficient; as a result we recommend you may have to adjust cooking temperatures. In an ILVE oven a moderate to hot temperature is 175°C. You will find this temperature will not need to be exceeded, except for specific cooking requirements which call for high heat over a short period of time. Exceeding 175°C when cooking may result in food cooking too quickly on the outside while remaining undercooked inside. Remember to reduce the temperature by 20°C when using the fan forced function.

# OVEN SYSTEMS

Most ILVE electric ovens are multifunctional and feature 10 or 11 cooking modes (secondary ovens exempt). This enables you to choose from a variety of functions depending on your cooking needs. Selection of the correct mode and oven temperature are important to obtain the best possible cooking results. All modes are pictured on your control knob and are numbered clockwise.

ILVE electric ovens are equipped with rear, top and bottom elements, which can be used individually or together; radiating heat from above and below simultaneously or individually for specialist tasks such as au gratin style cooking, crisping pork crackling or to brown off a roast.

The ILVE electric oven also has a quick start or preheat mode which allows the oven to heat from 0 –175oC in just 6 to 8 minutes.

## **Cavity cooling fan**

ILVE ovens are equipped with a cavity cooling fan. The fan is thermostatically controlled and will switch on automatically when the oven cavity reaches a temperature of 60o C. Air will gently be blown out through the front louvre, just above the oven door handle. This keeps the interior of the cavity housing cool.

The cavity cooling fan will continue to run after the oven has been turned off. The fan will automatically shut off once the oven cavity has reached a suitable temperature.



## Key



Minute minder



Automatic cooking time



End of cooking time



Clock



Timer settings

## Digital clock (24 hour clock)



Always ensure the oven is in manual mode . The pot symbol with the steam coming from it should be displayed. If there is an [A] on the display it means that the oven is in auto mode, to cancel this you must press both pot symbol buttons simultaneously. The oven will not operate if it is pre-programmed; it has to be brought back to manual mode.

### 1. To set or adjust the time:

Press both pot buttons simultaneously and then to adjust the timer press either the plus or minus - + button accordingly.













### 2. To set the alarm:

Hold in the bell button then the plus + button until you reach the required time. If you go over the required time, press the minus - button to bring it back. You will now notice a bell symbol on the display, this highlights that the alarm is on. If you need to check how much time is left on the alarm, press the bell button again as this will return to the time display. When the alarm goes off the oven will remain on and will ring for seven minutes unless turned off, which can be done by pressing the bell button. You can adjust the tone of the alarm-only when the alarm is ringing press the minus - button and it will scroll through three available tones. Select the tone that you require, this tone will then sound the next time you set the alarm.

### 3. Pre-programming the oven:

Press the button. Put in the duration that you want to cook the item for by pressing the + button. Press the button. Select the time that you want the item to finish cooking (by pressing the + button). You then need to select the mode and temperature.

# ELECTRIC OVEN COOKING MODES

ICON	MODE	FUNCTION
	<b>MODE 1</b> Pizza mode	ILVE's unique Pizza mode has been specifically designed for you to cook the perfect Pizza To achieve perfect results; turn the oven thermostat up to 250 degrees (best temperature for pizza cooking) ILVE's pizza mode will do the rest by turning on all elements in the oven at 30% and the bottom element on at 100% of their capacity. This ensures you get a nice crispy base with the assistance of the other elements at lower heat to cook the top of your pizza. For best results it is recommended that ILVE's pizza stone be used on the middle shelf when using this function.
	<b>MODE 2</b> Conventional oven mode	This is the traditional static oven mode with no fan allowing heat from both above and below to convect simultaneously. This is the ideal function for cooking heavy cakes such as mud cakes or banana cakes, Christmas cakes, breads and large roasts. Such items need to be placed in a central position in the oven.
	<b>MODE 3</b> Lower floor heating mode	This mode allows heat from the base of the oven. It is suitable for long, slow cooking such as stews and casseroles or for blind baking and finishing pastries.
	<b>MODE 4</b> Upper element mode	In this mode the upper outer element is in use. The permits 'Au Gratin' style cooking for a firm crust.
	<b>MODE 5</b> Conventional Grilling mode	In this mode the complete inner roof element heats up creating direct infra-red heat from above. With this mode you should grill with the door closed.
	<b>Rotisserie mode</b> (All models except 600mm and P70 Series ovens)	The rotisserie mode works in a similar way as traditional grilling and is one of the best ways to cook meat and poultry. With a right hand side motor drive in the oven, or in the rear of the 300mm & 400mm ovens. The ILVE rotisserie can accommodate up to two joints of meat or portions of poultry at once.
	<b>MODE 6</b> Fan Grill	This mode utilises the fan combined with the infra-red grill to ensure hot air is circulated evenly around the oven. This is the ideal mode to use when multitasking, grilling chops and sausages on the top level whilst baking a potato bake on the lower level. For best results the door should be closed during this grilling mode.
	<b>MODE 7</b> Fan Assist	With both the top and bottom elements in use and the fan circulating hot air, this cooking mode is best suited for bread, cakes and sponges, where very even temperatures are required, even in the corners of the oven. This mode also creates less splatter when roasting.
	<b>MODE 8</b> Fan Forced	The fan in all ILVE ovens is surrounded by a triple ring heating element that evenly distributes heated air throughout the oven. This mode is perfect for batch baking biscuits or muffins and most general cooking tasks. <b>IMPORTANT</b> – Ensure you reduce the temperature by 20°C. Mode 8 is also the self-cleaning mode in models, which have self cleaning liners.
	<b>MODE 9</b> Quick Start or Pre-heat mode	To obtain the best result from your oven it is recommended that you preheat it prior to use. Combining an advanced hot air function and conventional heating mode ILVE ovens can reach a temperature of 175°C in just 6 – 8 minutes. Once preheated the required cooking mode should be selected before proceeding with cooking.
	<b>MODE 10</b> Defrost mode	This function allows you to fan defrost at an ambient temperature. Unlike defrosting using your microwave this mode does not dry or par-cook food.
	<b>Roasting probe</b> (For models 948 Series, 600SSXMP & Majestic Series only)	Some ILVE models are equipped with a microprocessor controlled roasting probe which can be used to cook roasts to a precise finish either rare, medium or well-done, taking the guess work out of cooking.



**PLEASE NOTE:** To turn the oven light on or off during cooking, simply push in the oven control knob.

### Preheating

Always preheat your ILVE oven to at least 175oC before placing food in it. To do this use the Quick Start mode (Mode 9) on your control knob.

Set your oven to 175oC, after the oven has reached temperature, indicated by the temperature light turning off, you may then switch the oven to your required mode.

### Roasting Probe

ILVE's premium models are equipped with a microprocessor controlled roasting probe which can be used to cook roasts to a precise finish. The probe is thermostatic and is inserted into the thickest part of the roast away from the bone. When the probe is fitted to the connection point, the thermometer activates. By pressing the + or - buttons you can program the probe to the desired temperature for

the roast (to reset remove the probe from oven).

### How To Use The Roasting Probe

Before putting the meat into the oven, insert the sharp end of the probe into the centre of your cut of meat being sure to keep away from any bones as this will give a false reading to the temperature detector. Then insert the other end of the probe into the connection point at the top right hand corner of your oven, you will notice your display now shows two sets of numbers – the numbers on the left represent the meat at that time, the numbers on the right represent the desired temperature you would like the meat to be at the end of cooking. To alter this, press the + or - buttons until you get the desired temperature.

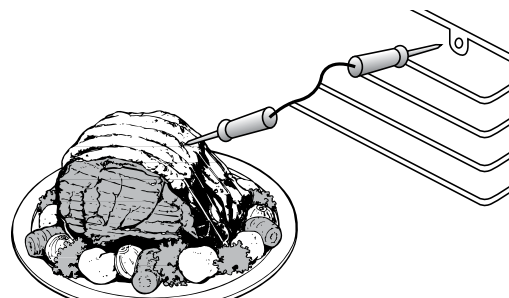

### Roasting guide:

- Rare 60°C
- Medium 70°C
- Well-Done 80°C

If the meat is left in the oven an alarm will sound and the oven will turn off when the desired temperature is reached. Set the function and thermostat knobs to your desired settings and your oven will do the rest. If you like you can also use the minute minder whilst using this feature for multi-tasking.

## Electric oven function selection

FUNCTION											
TYPE OF FOOD	PIZZA	DEFROST	ADVANCED HOT AIR	FAN ASSIST	FAN GRILL	CONVENTIONAL GRILL SYSTEM	UPPER ROOF ELEMENT	LOWER FLOOR ELEMENT	CONVENTIONAL HEATING	ROTISSERIE	ROASTING PROBE
Pizza	•										
Meat Roasts		•	•	•	•				•	•	•
Small Cuts		•	•	•	•				•		
Steak/Sausages					•	•					
Whole Fish Fillets		•	•	•	•	•			•		
Poultry Whole Pieces		•	•	•	•	•			•		
Combined Meats		•	•	•							
Pastry Dishes – Pies, Quiche etc.			•	•				•			
Egg Dishes – Souffle, Pavlova, etc.			•						•		
Bread			•					•	•		
AuGratin/Crumb Cheese						•	•				
Toasted Sandwiches						•					
SHELF POSITION	2-3	ANY	ANY	2-3	3-4	3-4	3-4	1-2	2-3	1	1-3

There are two ways to grill food in an ILVE electric oven; by using radiant heat to cook the food or by using thermal grilling, a combination of radiant heat with thermal air flow.

The full roof area conventional grill system uses automatically controlled direct infra-red heat radiated from above for traditional grilling applications. ILVE ovens combine the advantages of infra-red heat with fan forced air assistance, allowing grilling and baking on two different levels at the same time.

Both cooking techniques give exceptional results for a wide range of meat cuts such as chicken breasts, beef steaks, lamb and pork. It is also ideal for grilling fish and fish fillets.



### MODE 5 Full roof area conventional grilling mode



In this mode the inner roof element heats up creating direct infra-red heat. This mode allows you to grill with the door closed. Grilling with the door open ajar may lead to the control knob heating up slightly.

### MODE 6 Hot air grilling system

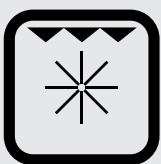

This mode utilises the fan combined with the infra-red grill to ensure hot air is circulated evenly around the oven. This is the ideal mode to use when multitasking, grilling chops and sausages on the top level whilst baking a potato bake on the lower level. The door must be closed during this grilling mode.

### Traditional grill

1. Select the grill mode (Mode 5) on the function control knob.
2. Turn the temperature control knob to 200° C.

The oven heating indicator light (orange light) at the front control panel comes on when the thermostat is activated and turns off once it has reached the selected temperature setting.

### ILVE TIP

- When conventional grilling the oven door should always be closed
- The best settings for conventional grilling is between 175 – 190° C.
- For best results, we recommend grilling on level 4.

### Fan grilling

1. Position racks at heights according to food types and thickness (See hot air grill cooking guide)
2. Select the fan grill mode (Mode 6) on the function control knob.
3. Turn the temperature control knob to 175° C.
4. Allow oven to preheat for a minimum of four minutes depending on food types.

When fan grilling on multiple shelves the oven door must be closed. The grill element at the top of the oven produces intense heat to sear the surface of the food while the fan moves this heat around the oven. Fan grilling eliminates the need to turn food over during the grilling process; however, turning is optional depending on the degree of browning desired. When using this function make sure that food is elevated to allow the hot air to circulate around the food. Food can be placed on the grill rack that sits inside the baking tray alternatively; food can be placed on a grill rack positioned over an oven pan to make sure any drips are caught.

### ILVE TIP

- The oven door should always be closed during hot air grilling.
- The temperature should be set from 175 – 180°, this range in temperature helps prevent food from burning and avoids splatter, minimising the need for cleaning.
- The shelves are numbered 5 to 1 from top to bottom (See diagram above right).

### Shelf positions

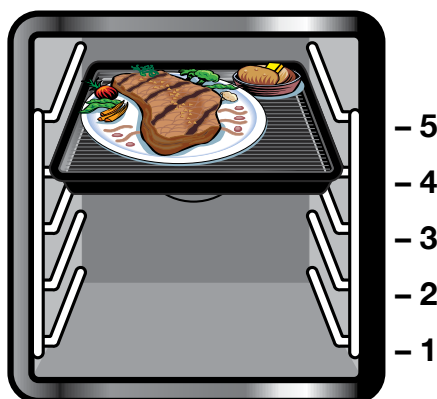

### IMPORTANT!

Do not place anything on or cover the base of oven as this impedes the transfer of heat from the bottom element to the oven cavity and can cause irreparable damage to the oven base.

### Grilling guide

FOOD TO BE GRILLED	RECOM-MENDED SHELF POSITION	TRADITIONAL GRILLING		FAN GRILLING	
		OVEN TEMP	GRILLING TIME 2	OVEN TEMP	GRILLING TIME 2
<b>THIN CUTS</b>					
Steaks	3 - 4	200°C	10 - 16 mins	175°C	10 - 16 mins
Vegetable Kebabs	3	200°C	15 - 20 mins	175°C	15 - 20 mins
Meat Kebabs	3	200°C	15 - 20 mins	175°C	15 - 20 mins
Cutlets / Schnitzel	3 - 4	200°C	12 - 18 mins	175°C	18 - 20 mins
Liver	3 - 4	200°C	8 - 12 mins	175°C	10 - 14 mins
Burgers	3 - 4	200°C	14 - 20 mins	175°C	16 - 20 mins
Sausages	3 - 4	200°C	10 - 15 mins	175°C	8 - 12 mins
Fish Fillets	3 - 4	200°C	12 - 16 mins	175°C	12 - 16 mins
Trout	3 - 4	200°C	16 - 20 mins	175°C	20 - 25 mins
Toast	3 - 4	200°C	2 - 4 mins	175°C	3 - 5 mins
Cheese Toast	3 - 4	200°C	7 - 9 mins	175°C	4 - 6 mins
Tomatoes	3 - 4	200°C	6 - 8 mins	175°C	6 - 8 mins
Peaches	3	200°C	6 - 8 mins	175°C	7 - 10 mins
<b>THICKER CUTS</b>					
Chicken (1kg)	2	–	–	175°C	50 - 60 mins
Rolled Meat (1kg)	1	–	–	175°C	75 - 85 mins
Pork (1kg)	1	–	–	175°C	100-120 mins
Sirloin (1kg)	1	–	–	200°C	25 - 35 mins

1) Select the appropriate shelf level for the thickness of the food.

2) Turn food over half way through the grilling time.

Note: The information given in this chart is intended as a guide only.

# USING THE ROTISSERIE

ILVE's Rotisserie mode is represented by one of these symbols:

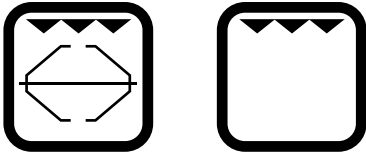

How to use your Rotisserie

- Remove all oven shelves and the wire grid from the grill tray and pre-heat the oven to 175°C.
- Sit the rotisserie cradle on to the grill tray.
- Slide one fork onto the rotisserie rod and secure with the wing nut.
- Slide your cut of meat onto the rod being sure to pierce the centre of the cut. If cooking a whole chicken remember to truss the legs first. Then slide on the other fork and secure the wing nut.
- Place the rod onto the cradle.
- Slide the grill tray onto shelf number 1 and insert the right hand end of the rod into the round motor casing. The indentation on the left end of the rod should be sitting on top of the cradle so it turns easily.
- Turn the function knob to Grill mode 5. The rotisserie will start turning.
- When the meat is cooked remove from the cradle by using the rotisserie hook and plastic handle. Using the hook, lift the left hand end of the rod and remove it from the motor socket. Slide the grill tray out and using the black plastic handle on the left hand end, wind onto the rod. Then with the hook on the right hand end of the rod, lift the rod off the cradle and onto your serving plate.
- You can also use the black plastic handle to loosen the wing nuts of the forks.

PLEASE NOTE: IF YOU HAVE A GAS OVEN, PLEASE REFER TO PAGE 26

# USING THE ROTISSERIE

## Tips on how to use the Rotisserie



With your rotisserie kit you will get:

1. Black plastic spit handle
2. Spit hook
3. Spit rod
4. Spit forks



Slide meat onto the rotisserie rod and press meat onto the fork and secure in place by tightening the wing nuts.



The left end of the rod rests on the cradle allowing the rod to rotate



The right end of the rod is inserted into the rotisserie motor socket

# OPERATING - GAS COOKTOP

**LIGHTING BURNERS** – simply press the knob in, turn anti-clockwise to maximum, the electronic igniter will spark and ignite the burner. Check that the gas has been lit; if the burner fails to ignite repeat the above process.



● OFF- ● maximum- ● minimum

For models with Flame Failure follow the above procedure but keep the knob fully depressed for up to 10 seconds after ignition to allow the safety to lock in. Check that the gas has been lit; if the burner fails to ignite repeat the above process. If the burner still fails to ignite, a match or lighting device can be used, but care must be taken. Keep igniters dry. If the problem persists, contact Eurolinx Pty Ltd or their appointed agent for service.

**DO NOT TOUCH HOT SURFACES, ALLOW HOB TO COOL BEFORE WIPING SPILLAGE.**

## PRACTICAL HINTS FOR USE

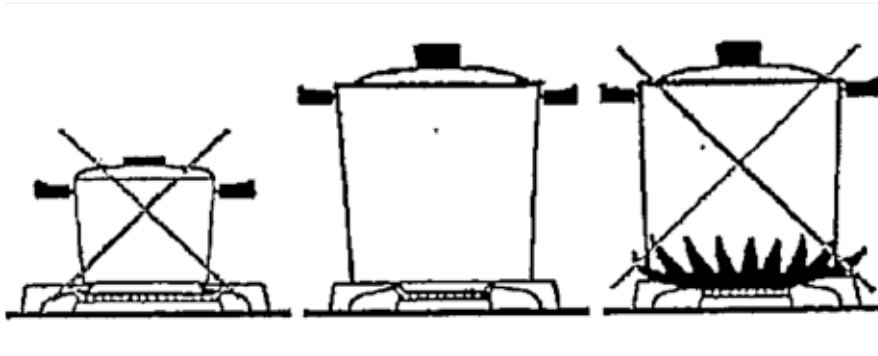

### WARNING

Do not use pots which exceed the width of the trivet (the trivet is the frame with fingers that the pot sits on). If pot size exceeds the edge of the trivet, flames could cause damage to work surfaces either side of the burner. Do not use pots which are too small for the burner size, they become unstable on the trivet.

Always use a vessel for cooking that is appropriate in size for the size of burner. Never use pots that are too small or too large. For wok cooking it is recommended that a domestic size wok, no larger than 400mm in diameter be used.

Always use the small pot trivet for pots with a base smaller than 100mm.

Use a strong flame to bring liquids to boil, seal meat and generally for all food which must be cooked rapidly i.e. when using a wok.

Use a low flame for sauces or stews.

Do not cook food over too strong a heat. Boiling food fast does not cook any faster but violently stirs up the food causing it to lose flavour.

# TEPANYAKI PLATE (FRY TOP)

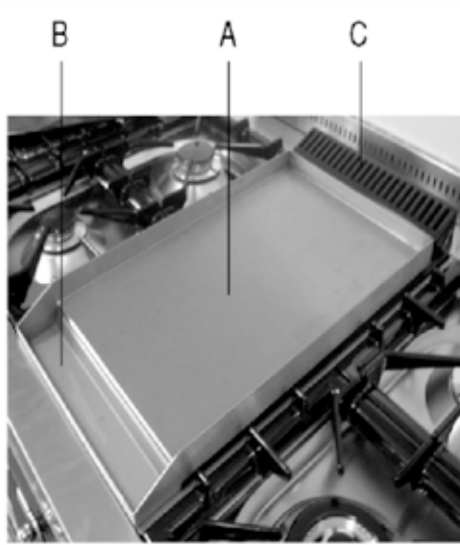

Figure 1



- A = cooking tray
- B = drip tray
- C = exhaust flue for combustion fumes

The Fry-Top is composed of a special stainless steel plate (8mm thick), specially designed to have temperatures evenly distributed over the whole surface so that you can utilise the complete cooking surface. The plate also has hygienic advantages.

Another advantage is the high heat accumulation of the plate, with very low heat loss. To use the appliance, light the flame below the plate by means of the corresponding knob (see “Lighting the burners”) and ensure that the flame is burning.

Leave the knob in this position for about 10 minutes at the most and wait for the plate to heat up. Once this period has elapsed, the plate is ready to start cooking.

By adjusting the flame, there is no limit to your culinary imagination. If you turn the knob to minimum, you can do slow cooking or types of cooking in which you want to maintain the organic properties of the foods. Higher temperatures are suitable for cooking meat, fish and vegetables.

The Fry-Top plate is ideal for Japanese Tepanyaki cooking: the special lid needed for this type of Oriental cooking is available as an optional accessory.

Some models are supplied with the spatula shown in above, which is useful for both cooking and for cleaning the plate.

## Control Knob Settings

### Control Knob Settings

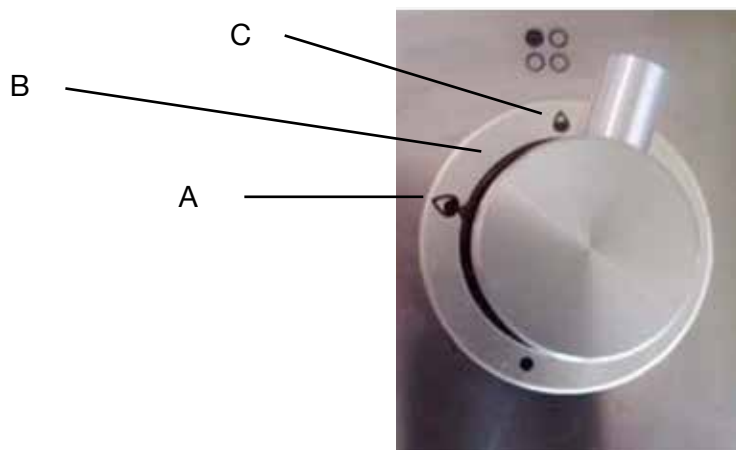

A = Max - B = Med - C = Min

## COOKING TABLE

(purely indicative values after 10' preheating with the burner at maximum power)

KNOB POSITION	TYPE OF COOKING
B	egg's in 2 minutes
B	sliced eggplant (0.5cm thick) from 9 to 13 minutes
B	sliced potatoes from 5 to 7 minutes
B	sliced courgettes from 3 to 5 minutes
B	fish (portions of about 200g) in 15 minutes
B	steak in 3 minutes
A	T-bone steak (2cm thick) in 5 minutes

## CLEANING AND CARING FOR THE TEPANYAKI PLATE

Allow the tepanyaki plate to cool slightly and pour on white vinegar. Allow to sit for five minutes then scrape the plate with a flat spatula. For heavy build up a scourer may be required. Quickleen S is recommended as a great cleaning solution (Available online).

# SIMMER PLATE (COUP FEU)

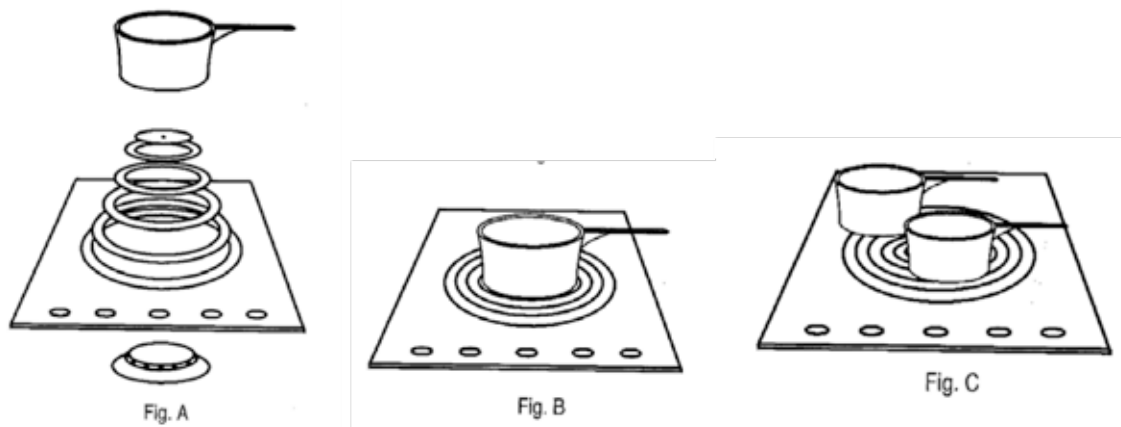

## Use of the Coup Feu

The large “Coup feu” solid cast iron plate made of concentric rings allows you to rest the pan (or even several pans) directly on the surface (fig. B, C). It is heated by means of a gas burner (fig. A). The plate is designed to provide a moderately intense heat which is well distributed over the surface. This is ideal for slow cooking and particularly for sauces, browning and grilling, heating dishes or keeping them warm. Switch the burner on 15/20 minutes before use to allow the cast iron plate to accumulate heat. You will then be able to use the plate even when switched off for a further 10/15 minutes. The middle of the plate is the area where the highest temperatures are reached whereas the outer part is cooler. By simply moving the pan from the middle to the outside of the plate, you can obtain different cooking intensities without regulating the flame. Pan dimensions permitting, several dishes can be cooked at the same time (fig. C). If necessary it can be used as a handy top, providing ample space for resting pots and pans.

## Cleaning the Coup Feu

The hotplate should be cleaned while still warm using the products normally used in the kitchen for metal surfaces. Rub with a wire pad, following the direction of the satin finish. Dry well immediately. If you want to give the plate a better appearance, after cleaning, apply a coat of Supercromo paste.

If you do not intend to use the hotplate for long periods, after normal cleaning apply a thin film of liquid paraffin (Vaseline oil) with a wad of cotton wool. This treatment is necessary to prevent any formation of surface oxides. When next turning on the plate you will notice the evaporation of the paraffin oil used. This phenomenon will disappear in a few seconds. The hotplate may sometimes present surface oxidation due to the presence of humidity, but above all due to lack of use. You are therefore advised to use it frequently to prevent any oxidation. Never leave the hotplate damp. If the oxidation phenomenon still appears, use lightly abrasive paper to remove it, taking care to rub gently, always in the direction of the plate satin finish.

Do not cook food directly on the plate surface. Always use suitable containers / cooking equipment.

# ELECTRIC BBQ (LAVA GRILL)

The Lava Stone BBQ allows you BBQ meats and fish with out the use of oils. The lava stones placed under the electric element enables a constant temperature (250°C) and the absorption of fats without smell and vapor. The grid, tray and lava stones are easily removable for the cleaning. Before turning on the appliance, check that all parts are well installed. To turn on the BBQ rotate the knob to the desired setting between “1” and “12”; the indicator light will be illuminated, indicating that the appliance is working. When the knob is turned to the “0” position the appliance is turned OFF and the indicator light will go out. Important: To grill, we recommend pre-heating the grill element and lava stones for approximately 10 minutes on position “12”, this allows the lava stones to reach the required temperature to vapourise the fats and liquids from the meat to enhance the flavour of the produce being cooked.



fig. 20

## Cooking Table

Table for grilling on lava stones		
Dishes	Position	Time in min.
Sausages	12	13
Steaks	12	12
Hamburgers	12	14
Filet steak	12	8
Liver	12	5
Lamb cutlets	12	8
Chicken steaks	12	9
Chicken drumsticks	12	17
Sliced salmon	12	10
Trout	12	12
Trout cooked in foil	12	30-35

## CARING AND CLEANING FOR YOUR LAVA STONE BBQ

Before cleaning, disconnect the appliance from the mains. Cleaning must be carried out when the appliance is cold. Remove all the removable parts. Remove the grid, lift the heating element and take away the hob bed with lava stones. Stainless steel parts must be cleaned with water and detergent, then dry with a soft cloth carefully. Under no circumstances use corrosive or abrasive detergent, this could damage the appliance. Stainless steel, brass or copper parts must be treated by using the proper products, thus keeping the brightness for a long time. Control Panel and aluminum parts must be cleaned by means of degreasing detergent.



# CERAMIC ELECTRIC HOT PLATE

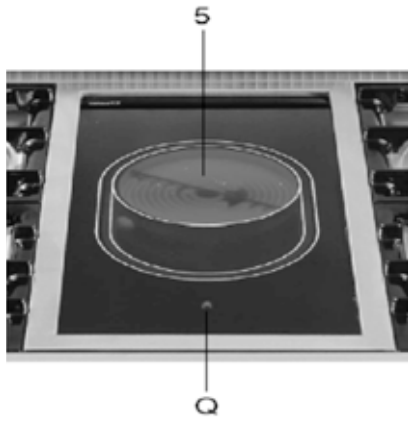

## INSTRUCTIONS FOR USE OF THE ELECTRIC PLATE

The vitreous ceramic electric plate (5) is controlled by a knob (as above energy regulator). A pilot light comes on as soon as the heating element is activated. The control knob is graded from 0 to 12. Position 0 indicates that the corresponding cooking area is switched off. Position 1 indicated that the corresponding cooking area is at the minimum power, while position 12 indicates that the cooking area is at maximum power.

The energy regulator controls the cooking area with two circuits (5). When the knob is turned clockwise from position (off) to the desired position (1-12), the primary part of the cooking area is switched on. To switch on the secondary part, turn the knob to position 12 and then turn it past position 12 as far as it will go in a clockwise direction. At this point the secondary circuit switches on too and it is possible to vary the power from 1 to 12 (1 = minimum, 12 = maximum)

## RESIDUAL HEAT WARNING LIGHTS

Important: The ceramic hob cooking surface remains hot for a long time after use. Do not touch the hob with your hands or let children near it. The residual heat indicator (Q) will remain lit until the hob has cooled down.

If any cracks appear in the ceramic hot, disconnect the appliance immediately from the mains and call an authorised technical service centre

## ELECTRIC HOTPLATE

For efficient use and low energy consumption, it is advised to use pans specifically designed for electric cooking on ceramic hobs. The bottom of the pan must be thick and flat. Its diameter must be as similar as possible to that of the cooking ring. The surface of the hob and the bottom of the pan must be kept clean.

- A** – Do not leave the hotplate switched on without a pan
- B** – Do not wet or overheat the plates
- C** – Avoid sudden changes of temperature on the ceramic hob. For example, do not pour cold water onto the hot hob.

- D** – Ensure that the pan covers the whole cooking area.
- E** – The bottom of the pan must be flat and dry so as to use less energy and keep your ceramic hob in good condition.
- F** – Do not leave the pan handles sticking out as they could be knocked over accidentally.
- G** – Do not forget that the cooking area remains hot for quite a long time even after it has been switched off. Make intelligent use of this characteristic by switching off the cooking area a few minutes before completing cooking. The residual heat that has been accumulated in the ceramic will thus enable you to complete cooking without using more electric power.
- H** – It is preferable not to cook on the ceramic hob with pans that have been used on gas burners. The flames will have deformed the bottom of the pans. Do not use aluminium pans on your ceramic cook top as this metal is very soft and can damage and/or permanently stain your cook top.

**Cooking Table** - (The following table is a guide only to settings for a variety of foods.)

Knob position	Type of cooking
1-2	melting butter, chocolate, etc
3-4	heating small amounts of liquids, keeping food warm, preparing sauces
5-6	heating solid foods, thawing frozen foods, omelettes with 2-3 eggs, fruit and vegetable
7-8	cooking with meat and fish, pulses in sauces, dishes with water, making jam
9-10	roasting meat or fish, steaks, liver, eggs
11-12	boiling large amounts of water, frying chips, etc

## CLEANING THE CERMANIC HOB

The flat surface of the ceramic hob makes it considerably easier to clean than traditional hobs. Clean the hob in the same way as any glass surface in your home. For more accurate cleaning, a special product may be used which can be supplied by Ilve Spare Parts. Never use abrasive products. Routine cleaning must be carried out when the hob is cold. Caution: take care not to drop substances containing sugar on the hob during operation. If this should happen, immediately turn off the respective heating element and clean with warm soapy water before the glass cools. When performing this special cleaning, take particular care not to burn yourself.

We recommend cleaning the cooking top once it has cooled down. The stainless steel and painted parts must be cleaned with lukewarm water and anti-corrosive liquid detergents. Dry the parts with a soft cloth.

Never use steel wools or abrasive detergents. The brilliance of the stainless steel, brass and copper is obtained by using periodically detergents or similar products. The instrument panel and all the aluminum parts must be cleaned only with alcohol or degreasing products. Never use lemon on **MATT / GRAPHITE**.

# INDUCTION COOKTOP

The ILVE induction cooktops have been designed to make your cooking quick and easy. When using an Induction cooktop you will need to use specific cookware, this is due to induction technology using magnetic fields which transfer the cooking energy to the base of your cookware. You need to make sure that the cookware you are using has a magnetic base.

Due to the cooktop needing a magnetic base to work, the cooktop will not start to generate heat until it comes into contact with the magnetic field the cookware will create. Once the saucepan is removed the cooktop will automatically shut down until magnetic contact is reintroduced.

Even though the cooktop uses the base of your cookware as the heating element and not the cooktop you should still be aware that the cooktop surface may still be hot from residual heat. The cooktop display will have a **h** appear to indicate to you the surface may be hot and you should not touch it.

Cookware bases that will work on induction surface: enamel, cast Iron, stainless steel or magnetic bases.  
Cookware bases that will not work on induction: copper, glass, ceramic, aluminum.

## SAFETY DEVICES

Your ILVE induction cooktop has been installed with some safety devices. If you happen to boil dry a saucepan or pot, or if the cooktop reaches a dangerous temperature the cooktop will shut down automatically to prevent any harm to itself or your kitchen. The cooktop will also beep at you to alert you of a problem.

The cooktop is also fitted with a spill detection device, this means that if you have left something unattended and there happens to be a boil over, once the cooktop control panels senses a spill it will automatically shut down and beep at you to come and check what has happened.

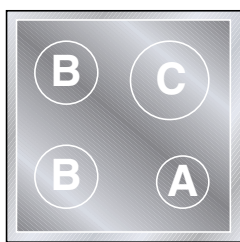

60cm

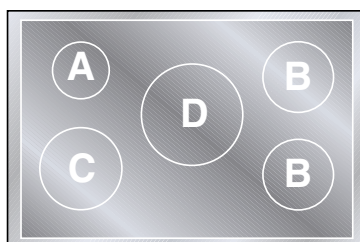

90cm

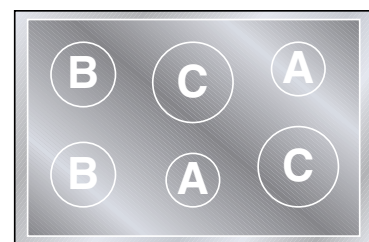

100cm

## TURNING ON THE COOKTOP

A cooking area is switched on by turning the respective knob clockwise. The set power level appears on the hob display (1-9). A cooking area is switched off by turning the respective knob anti-clockwise. The symbol (0) appears on the hob display for 3 seconds, and then it disappears from the display or changes to the symbol (H), if the cooking hob is still hot. The cook top will automatically switch off if any conditions of excess temperature or errors in power supply occur.

### POWER BOOSTER FUNCTION

The purpose of the booster function is to give more power to a determined area in order to reduce the necessary cooking time. This function is activated by turning the knob clockwise all the way to the final position. The Symbol (P) appears on the display, meaning that the booster function is activated. The booster function has a maximum duration of 10 minutes. The area concerned will then return to power setting (9).

### KEY LOCK FUNCTION

The key lock function is useful if there are children at home. The key lock function is activated, with the knobs in position (0), by turning the first and last cooktop controls anticlockwise. The letters (L) (L) (L) (L) (L) (L) appear on the display.

### KEEP WARM FUNCTION

This will keep food warm at a temperature of 65°C. Turn the knob in a clockwise direction. Between the off area position (0) and the power position (1) there is the position (U) which identifies the function for heating food to 65°C.

### AUTOMATIC BOIL AND REDUCE FUNCTION

The heat up function, or quick heating, is available on each cooking area. This means that for a defined time the cooking area works at maximum power and at the end of this time the power is automatically brought to the set level. In this case the duration depends on the set power level. The heat up function is activated by turning the knob anticlockwise from position (0) to the final position. As soon as the control is turned to the left, a letter (A) is shown on the display for the area. After it has been activated you must set a power level to continue cooking within 3 seconds.

## INDUCTION / TEPANYAKI COOKTOP

### INSTRUCTIONS FOR USE OF THE INDUCTION TEPANYAKI PLATE

There are a few differences between our models when it comes to Induction cooking. For use of your freestanding induction cook top refer to the notes above. The tepanyaki plate with induction is similar except for two main points. You don't need to have a booster on a tepanyaki plate. Boost is mainly used when boiling water. And there is also no need for a keep warm function as tepanyaki style cooking is predominately used on a high heat. It does have an automatic boil and reduce function. Refer to the notes above.

The tepanyaki plate needs about 5 minutes to preheat. You can use the induction zones with out the tepanyaki plate if preferred. Take care when removing and replacing the plate as it is very heavy and if dropped onto the glass it could cause damage.

# GAS OVENS

**IMPORTANT: The oven will not light unless the oven door is fully open.**

**DO NOT TOUCH HOT SURFACES. ALLOW OVEN TO COOL BEFORE WIPING SPILLAGES. Should a spill occur, allow surface to cool and wipe up the spillage from the cover over the burner, then remove the burner cover by sliding it towards the front of the oven and lifting it out. Wipe up any excess spillage that may have migrated into the base of the oven.**

There are upto five cooking options available with ILVE gas ovens (depending on the oven size):

1. Static Gas Oven
2. Fan Forced Gas Oven
3. Fan Grill
4. Static Grill
5. Rotisserie (80cm + 90cm Ovens Only)

**IMPORTANT: When your gas oven is being operated for the first time it is important to burn off the protective oils that are used in manufacturing from the grill element. To do this see ( using your grill element below ) and set the temperature to 9 and allow to burn for 15 minutes.**

## Lighting your gas oven

The oven will not light unless the oven door is fully open. To turn on the gas oven, open the oven door and turn the thermostat knob (B) anti-clockwise to 250°C and hold in for approximately 15 seconds. This will heat the thermocouple and allow the gas to flow through. (You do not need to use the knob (A) marked 1-12 at this stage.) You can tell that the oven is alight, looking through the small holes situated in the base of the oven you should see the flame.

Once the flame is lit, the door must stay open for 3 minutes (this ensures there is enough oxygen to keep the flame alight.) Then with the temperature knob (B) select the temperature required. Temperature range is from 100°C – 250°C. To achieve 100°C on the temperature knob (not visibly marked), there is a section when you turn the knob (B) towards the off position where it won't allow the knob to move/turn anymore without the knob being pressed in (which turns the oven off), and this is the 100°C gauge.

To turn the light on inside the oven whilst cooking turn the Function knob (A) to the very first icon (square box with light picture and rotisserie) this will turn the light on. At this stage the oven is heating from the base (gas flames are under the removable floor). There are 5 shelf levels in your oven. Level 1 is the bottom and level 5 is the top. For most cooking it is recommended to use shelf levels 3 or 4. **IMPORTANT - AFTER USING THE FAN ASSISTED MODE IN YOUR GAS OVEN, MAKE SURE YOU TURN THE FAN OFF OTHERWISE THE GRILL WILL BECOME ACTIVE.**

## Using the different functions in your gas oven

To use the Fan Forced function in the gas oven, once you have closed the door turn the Function knob (A) past the number 12, you will feel a click and hear the fan activate. This is now Fan Forced Gas Oven mode.

To turn off Fan Forced, turn the Function knob (A) back to the light icon. The benefit of Fan Forced Gas Oven is that the heat is distributed evenly through the whole oven. The rear fan circulates the air creating even temperatures inside the oven cavity. Fan Forced is most beneficial when doing batch/multi level cooking.

## Grilling

The Function knob (A) is for the grill function also. The grill is electric and will not work whilst the gas oven is on. To activate the grill turn knob (A) clockwise to number 8. This is equivalent to 180C. You can use the grill as a static grill (normal grilling with radiant heat) or you can choose to have fan grill.

## Static Grill

This is great for an intense heat e.g. Cheese toast, oyster Kilpatrick, Crème Brule. Static grill cooking use Level 4 for the best results.

## Fan Grill

This is great for cooking meat e.g. – skewers, sausages, cutlets and chicken pieces (wings and drumsticks.) On this function there is no need to turn the foods, the grill will brown the top of the food and the hot air which is being circulated by the rear fan, will cook it from the underside, locking in the juices and keeping the heat inside the oven. To activate the fan grill, turn knob (A) past the number 12 until you hear a click. This has activated the fan. Then turn the knob back to number 8 which is the best temperature for fan grilling. Keep the door closed when using fan grill.

TYPE OF FOOD	GRILL	OVEN	ROTISSERIE	SHELF
Meat Roasts		•	•	2-3
Small Cuts	•			4
Steak/Sausages	•			3-4
Whole Fish Fillets	•	•		3
Poultry Whole Pieces	•	•	•	3
Combined Meats		•		3-4
Pastry Dishes – Pies, etc.		•		2
Egg Dishes – Quiche, Souffle, Pavlova, etc.		•		2-3
Bread Pizzas		•		2
AuGratin/Crumb Cheese	•			3-4
Toasted Sandwiches	•			3-4

### Rotisserie

This is done on the static grill function. The rotisserie can weight bear up to 8kg. Skewer your desired meats onto the rotisserie rod and secure in place with the forks. Set up baking tray (black tray) with the rotisserie cradle, this goes into level 1. Place meat inside oven and turn Function knob (A) to 12 for the first 8 minutes. This helps to ensure the skin will seal and lock in juices. After the 8 minutes, turn down to number 6 or 7. When the meat is cooked, remove from oven and allow to rest before carving. If you wish to cook your roast potatoes, put them in the oven at the same time as the meat. They will take longer to cook compared to normal roasting. Whilst the meat is resting, you may want to brown off the potatoes if desired. To do this, move the baking dish to level 4, turn function knob (A) to 9 and grill for 5 minutes or until browned.

\*NOTE: the electric grill will not work whilst the gas oven is in use.

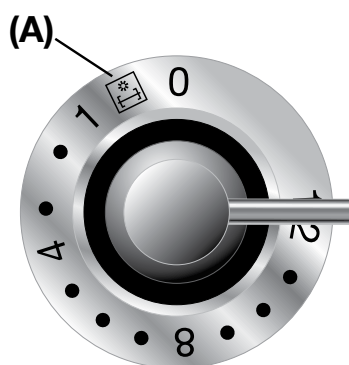

**Function knob**

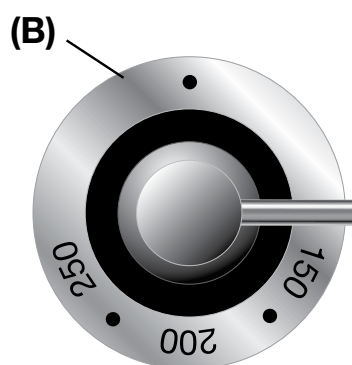

**Thermostat knob**

## Cooking In Your ILVE Gas Oven

An ILVE fan forced gas oven has the base burner situated under the oven floor. The advantage of ILVE's fan forced gas oven is that the heat is distributed evenly throughout, which makes it ideal for batch baking. However, the lower shelf is the hottest when baking so experiment with different shelf positions to obtain the best results.

The thermostat in ILVE gas ovens is mechanical; it operates on a different system than electric ovens. There is no indicator light on the front of the panel of the upright to show you when the oven has reached the correct temperature, however the gas oven heats up fairly quickly due to the powerful gas burner at the base of the oven.

A moderate to hot temperature in gas ovens is 175°C. You cannot switch between the mode of cooking in the gas oven like you can in the electric – if you are cooking on the fan forced and then wish to use the grill then you must start again and activate the electric grill element.

### Cakes

Cook cakes on the third shelf from the top on fan forced at approximately 150°C. This will give the cake a great colour and texture.

### Biscuits

If doing more than one tray of biscuits at a time then use the top three levels only. The bottom shelf in oven is far too close to the burner and biscuits will burn underneath.

Cook your biscuits at 140°C on fan forced so they cook evenly.

### Muffins

Cook at 175°C on the third shelf from the top of the oven on fan forced. Muffins cook very well in the gas oven with a great texture and very even colour .

### Roasting

Cook at 175°C on fan forced for half an hour per 500g. The gas oven is fantastic for roasting – the meat tends to be very moist and browns very well. Best cooked on the ILVE baking tray.

### Grilling

Grilling must be done on the second level from the top of the oven; the top level is too close to the grill.

# CLEANING, CARE & MAINTENANCE

Always wipe spills up when they occur. Do not leave spills to dry onto the surface of the hob.

**IMPORTANT – DO NOT PLACE ANYTHING ON OR COVER THE BASE OF THE OVEN AS THIS IMPEADS THE TRANSFER OF HEAT FROM THE BOTTOM ELEMENT TO THE OVEN CAVITY AND CAN CAUSE IRREPARABLE DAMAGE TO THE OVEN ENAMEL LINING. DO NOT TOUCH HOT SURFACES, ALLOW HOTPLATE TO COOL BEFORE CLEANING**

ILVE's advanced cooking system means lower and more accurate cooking temperatures and a reduction in cooking time and food splattering. These advances in oven design and technology means that ILVE ovens require less cleaning.

The introduction of the catalytic oven cleaning system and removable racks and door glass means that the task of cleaning your oven has become simplified. It is important to note that regular cleaning will keep your oven looking great and operating better for an extended time.

To maintain your oven you must do a self clean on a regular basis, approximately every two to three months of normal usage.

**NOTE:** Fat build up is easily distinguished by a slight discolouration of the liners

## 1. Before you start

As a safety precaution always switch off the power to the oven before commencing any cleaning or maintenance. never use abrasive scourers or spray any chemical oven cleaners or caustic solution on the catalytic oven liners as this may cause damage, wash instead with soapy water.

When removing oven shelves you must slide shelf out to the stopper using both hands before lifting front of the shelf up and sliding out. To replace shelves do the reverse of the above. It is advised that you wear oven mitts or heat protective gloves if oven has been turned on.

## 2. Catalytic self cleaning liners

Every ILVE oven (with the exception of the 600LM and Built-in Gas Oven models) has catalytic liners. These have been pre-installed in your ILVE oven to make your life easier. As you cook the liners will absorb any fat that splatters keeping your oven cleaner. There can be four liners in your oven; one on either side, one on the rear and one on the roof of your oven. Only the side liners are removable.

To maintain your oven you must regularly do a self clean to remove the fat absorbed in the liners during the cooking process. This may be weekly, monthly or yearly depending on oven usage. Fat build up is easily distinguishable by a slight discolouration of the liners.

To do a self clean; you must at the end of the cooking process turn the oven thermostat to 200 °C on fan forced heating system for 20 – 30 minutes. Always ensure that you remove excess trays (be aware as oven racks & trays will be hot), side racks and the fat filter as any fat will burn on these items making cleaning extremely difficult.



You may also need to wipe the door and inner glass if required.

Leave the oven with the door closed and in this time the fat absorbed in the catalytic liners will burn off the liners and the elements.

All ILVE ovens use easy clean vitreous enamel interiors giving a smooth black non staining appearance.

Once the oven is cool you may need to wipe the base of the oven with a damp sponge to remove the product of the burn off. The side liners can be washed in hot soapy water and are to be dried before placing them back in the oven.

The enamel of the oven should be wiped with warm, soapy water at regular intervals and after each use when cooking recipes with a high salt and or lemon content.

The fat filter at the rear of your oven has to be cleaned on a regular basis; the filter can be cleaned by hot soapy water, or in the dishwasher

NOTE: It is important that you to not use any caustic oven cleaner as this will ruin the liners

### 3. Removal of door & inner glass

For ease of cleaning ILVE have made their oven doors removable so that the interior oven glass can be removed and cleaned.

#### A. Removal of door

Open the door fully and lift latches (A) and hook into arm (B) on both sides. Lift door gently upwards

(C), as if closing, using both hands placed either side of the outer glass edge and door should loosen. Gently pull the door up towards you, if force is needed the door is not in the correct position and you will need to repeat the procedure. To refit the door reverse the procedure.

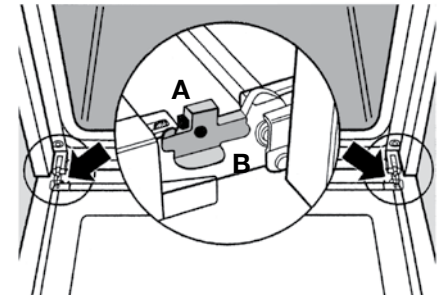

#### B. Removal of inner glass

ILVE oven doors are fitted with athermalic door glass panels, the inner panels are removable. To remove glass open the door fully and lift latches (A) and hook into arm (B) on both sides and unscrew the thumb screws (D&E) located on the top of door, remove top strip and gently remove glass (F&G) before washing in hot soapy water. The interior glass can also be cleaned with a damp cloth. When replacing the glass it is important that the tinted surface faces in towards the interior of the oven and that the top strip is replaced before screwing the glass back in place.

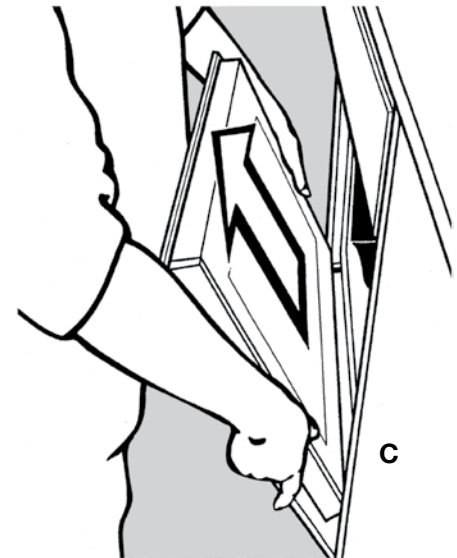

Please note: The oven doorglass must be replaced the same way it was moved with the tint facing the inside of the oven.

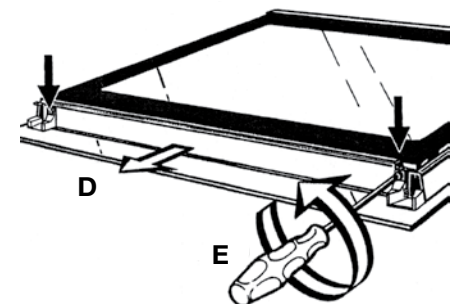

**IMPORTANT: NEVER USE ALUMINIUM FOIL ON THE BASE OF THE OVEN OR ON ANY ENAMEL SURFACE INCLUDING THE BAKING TRAY.**

To ensure for even heat distribution and longevity, remove the baking tray from the oven when you are not using it.

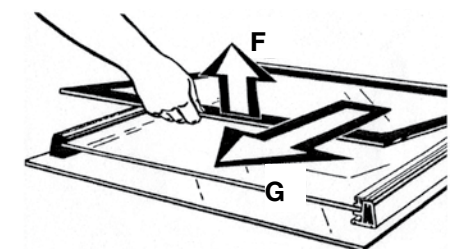

# CLEANING, CARE & MAINTENANCE

## Cooktops

Clean the stainless steel cooktop surface after each use with a clean cloth and normal detergent. Make sure the detergent does not contain chloride or any chloride compound. For persistent stains use warm vinegar or a non-abrasive cleaner. To make cleaning easier always wipe spills when they occur, do not leave them to dry as this makes cleaning harder.

## Trivets

Trivets should only be cleaned once they have cooled, to stop crazing from occurring. To clean trivets, wash in sink with warm soapy water then dry immediately using a clean dry cloth. Do not use anything too abrasive such as a chrome detergent as this may cause damage. The alkalinity of dishwashing detergents could damage the trivets. If you choose to wash the trivets in the dishwasher we recommend you use a hot rinse mode with no detergent. Enameled trivets may over a period of time discolour, this is due to exposure to a naked flame which may burn the enamel edge off the tips of trivets. This will not affect the performance of the cooktop. To remove surface staining use any cooking oil and a fine brush or scourer, lightly oiling trivets will also help in keeping their new appearance.

## Burner caps

The burner caps sit on the brass burners. To clean, remove and wash in warm water. Burner caps should not be put into cold water immediately after use, as crazing will occur, always allow caps to cool before cleaning.

## Brass burners

The brass burners will tarnish to a brown colour with use. To clean simply scrub with QuickKleen S (Available online) or soak in white vinegar for two hours to remove food splatter.

## Aluminium skirts

The aluminium skirt from the base of the burner may be washed in warm soapy water using a gentle scouring pad to remove any burnt on food splatter. A commercial product such as Autosol, which is designed for cleaning aluminium, can be used following makers' instructions. Do not put skirts in the dishwasher as this may cause the aluminium to discolour. You can also use QuickKleen S (available at all ILVE Showrooms or [shop.ilve.com.au](http://shop.ilve.com.au)).

## Stainless steel

Stainless steel can be cleaned using the ILVE cleaning cloth available from ILVE or a range of commercial products and stainless steel cleaners. Follow makers' instructions, taking care when cleaning around the graphics. When cleaning, be sure to follow the grain of the stainless steel as much as possible. Never use abrasive products on the stainless steel as it will scratch the stainless steel. Take care not to drop substances containing sugar on the hob, if this does happen clean with warm water immediately before the glass cools.

## Oven light replacement

Replacement globes are available from the Ilve service department. When changing over the lamp always switch off the power first. Unscrew the glass cover over the globe by twisting it anticlockwise. If glass cover is hard to unscrew, heat oven slightly, as this will heat any fat that might be congealed around the glass, and unscrew using a cloth. Remove existing globe and fit new bulb, refit the glass cover and switch on the power.

**NOTE: The light may be difficult to remove over time. Try using Multi-Grips being sure NOT to break the bulb and/or glass.**

### Rangehoods

Rangehood filters need to be washed regularly by using warm soapy water and dried using a soft dry cloth. There are various commercial products available which also may be used. Follow manufacturers' directions for use. Cleaning filters in the dishwasher: The heavy alkalinity of dishwashing detergents could damage filters. If you choose to wash the filters in the dishwasher we recommend you use a hot rinse mode with no detergent. Quickleen R is recommended as a great cleaning solution (Available online)

### Recommended cleaning products

#### Burner Skirts and Brass Burners:

- Autosol metal polish, available at automotive shops
- Autosol shine, available at supermarkets
- QuickKleen S (available at all ILVE Showrooms or [shop.ilve.com.au](http://shop.ilve.com.au))

#### Solid Plates:

- Hillmark solid hotplate protector, available at supermarkets

#### Ceramic Plates:

- Hillmark Cera-clean, available at electrical stores
- Hillmark CeraPol, available at Supermarkets

#### Enamel Interior of Ovens:

- Non-Caustic oven cleaner. Spray the cleaner onto a damp cloth rather than spraying directly into oven to prevent the spray getting onto the catalytic liners, which can cause damage.

#### Stainless Steel:

- ILVE Stainless Steel Cloth, available from ILVE Showrooms or [shop.ilve.com.au](http://shop.ilve.com.au)
- Cut back stainless steel solution for initial use only, available from ILVE Showrooms or [shop.ilve.com.au](http://shop.ilve.com.au)
- 3M Stainless Steel Cleaner and Polisher, available at supermarkets
- Gumption, available at supermarkets
- Watered down Windex (1/3 Windex to 2/3 water) available at supermarkets or use QuickKleen S

**IMPORTANT: Always use non-caustic cleaners on Ilve products The above products are recommendations only. ILVE will not be held responsible for any non ILVE product.**

**NOTE: ILVE sells a select range of cleaning products through our showrooms and on our NEW online shop.**



ILVE DVD available for purchase at [shop.ilve.com.au](http://shop.ilve.com.au)



# INSTALLATION INSTRUCTIONS

## GENERAL

1. The requirements of local Gas and Electrical authorities must be adhered to, Consult AS/NZS 5601 and SAA Wiring Rules as appropriate
2. Location of gas connection (See table)
3. Electrical connection (See Table)
4. Overall dimensions of hotplate Refer to dimensions chart in following pages
5. Eurolinx Pty Ltd and their appointed agents decline any responsibilities in the case of installation not according to these instructions.

## ELECTRICAL CONNECTION E GAS CONNECTION G

Model/mm	A	B
P60/PD120/QDC120	480	160
P70	530	220
PD70	530	240
P76	600	180
P80	680	200
P90/P120/P150	750	200
PD90/PD100/QDC90/QDC100	480	200
PT100	480	190
PT110	530	250

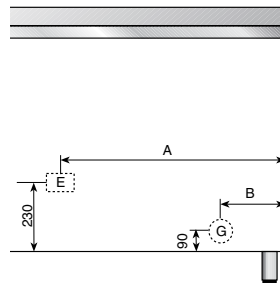

Rear View

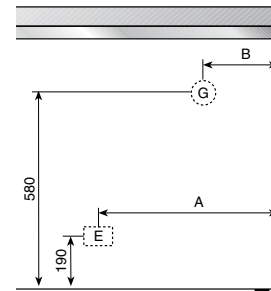

Rear View PD70-PT100-PT110

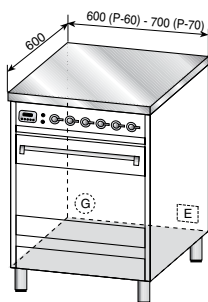

P60-P70

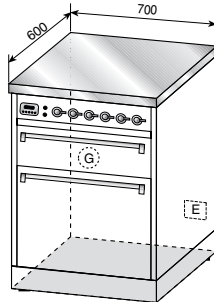

PD70

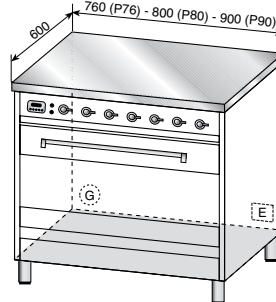

P76-P80-P90

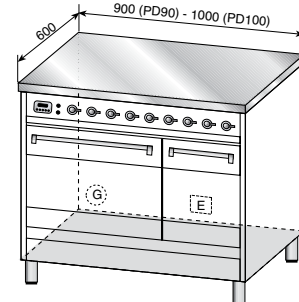

PD90-QDC90-PD100-QDC100

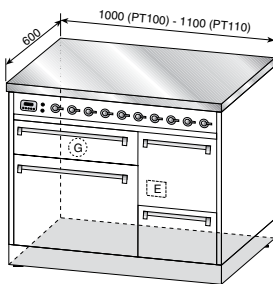

PT100-PT110

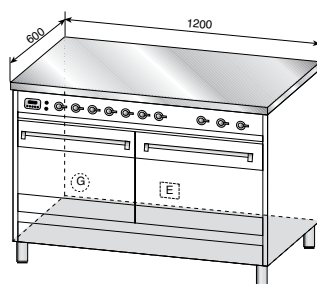

PD120-QDC120

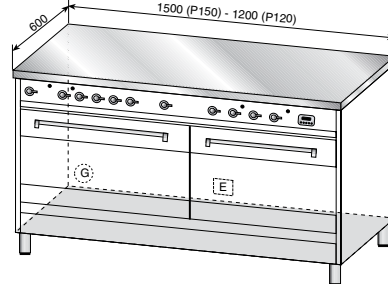

P120-P150

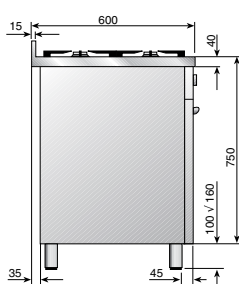

Side View

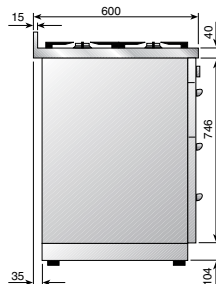

Side View PD70-PT100-PT110

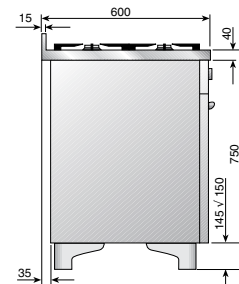

Side View QDC (Classic)

# INSTALLATION INSTRUCTIONS

Model/mm	A	B
M-70/MT-70/MC-70	520	200
M-90/MT-90/MC-90	750	200
MD-100/MTD-100/MC-100	460	230
M-120/MT-120/MC-120	700	290
MD-120/MDT-120/MDC-120	675	230
M-150/MT-150/MC-150	730	220

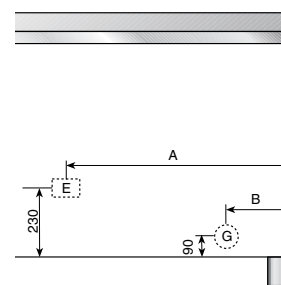

**Rear View**

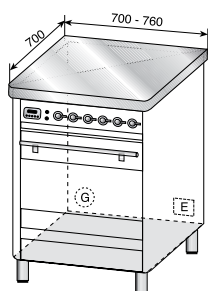

**M70-MT70-MC70**

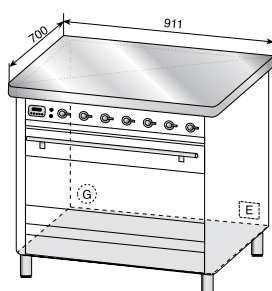

**M90-MT90-MC90**

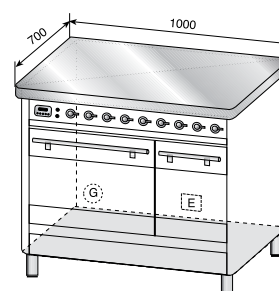

**M100-MTD100-MCD100**

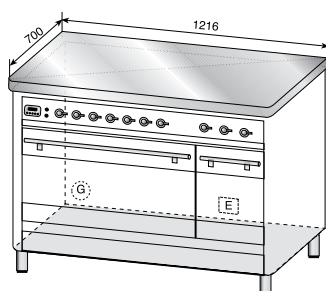

**M120-MT120-MC120**

**MD120-MTD120-MCD120**

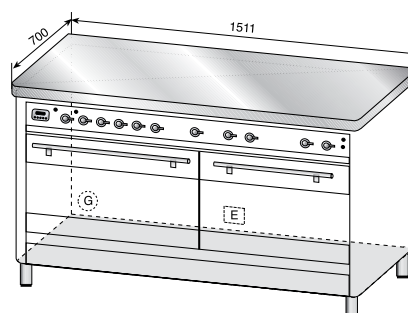

**M150-MT150-MC150**

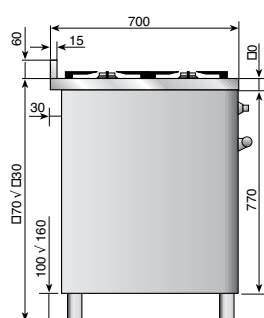

**Side View-Majestic Techno**

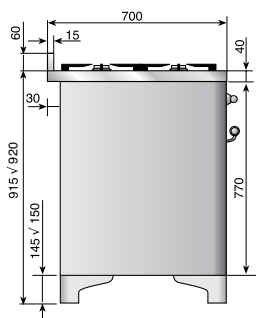

**Side View-Majestic**

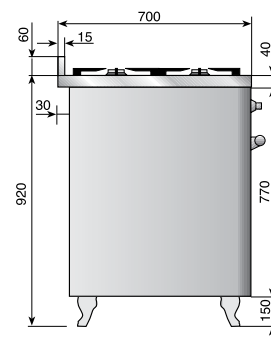

**Side View-Majestic Country**

## DISCLAIMER

Eurolinx PTY LTD, trading as ILVE Appliances, is continually seeking ways to improve the design specifications, aesthetics and production techniques of its products. As a result alterations to our products and designs take place continually. Whilst every effort is made to produce information and literature that is up to date, this brochure should not be regarded as an infallible guide to the current specifications, nor does it constitute an offer for the sale of any particular product. Product dimensions indicated in our literature are indicative only. Actual product only should be used to define dimension cutouts. Distributors, and retailers are not agents of ILVE Appliances and are not authorized to bind ILVE Appliances by any express or implied undertaking or representation.

# CLEARANCES

Rangehoods and overhead exhaust fans must be installed according to the manufacturers' instructions and local regulations but in no case shall clearance from hob burners be less than 600mm for the rangehood and 750mm for the overhead exhaust fan.

At all times gas safety regulations and local building codes must be adhered to.

**Removing Legs and placing oven on a plinth** If the legs are removed and the oven is placed on a plinth, then suitable ventilation from the plinth area is required. It is recommended that an air vent 20 mm wide and a length of 100mm less than the width of the oven it is be located at the rear in the base of the plinth. If the area under the plinth is sealed it is also recommended that an additional vent be included at the top of kick panel under the plinth to provide adequate circulation. The vent size should be 10mm high and 100mm less than the width of the oven.

# INSTALLATION INSTRUCTIONS

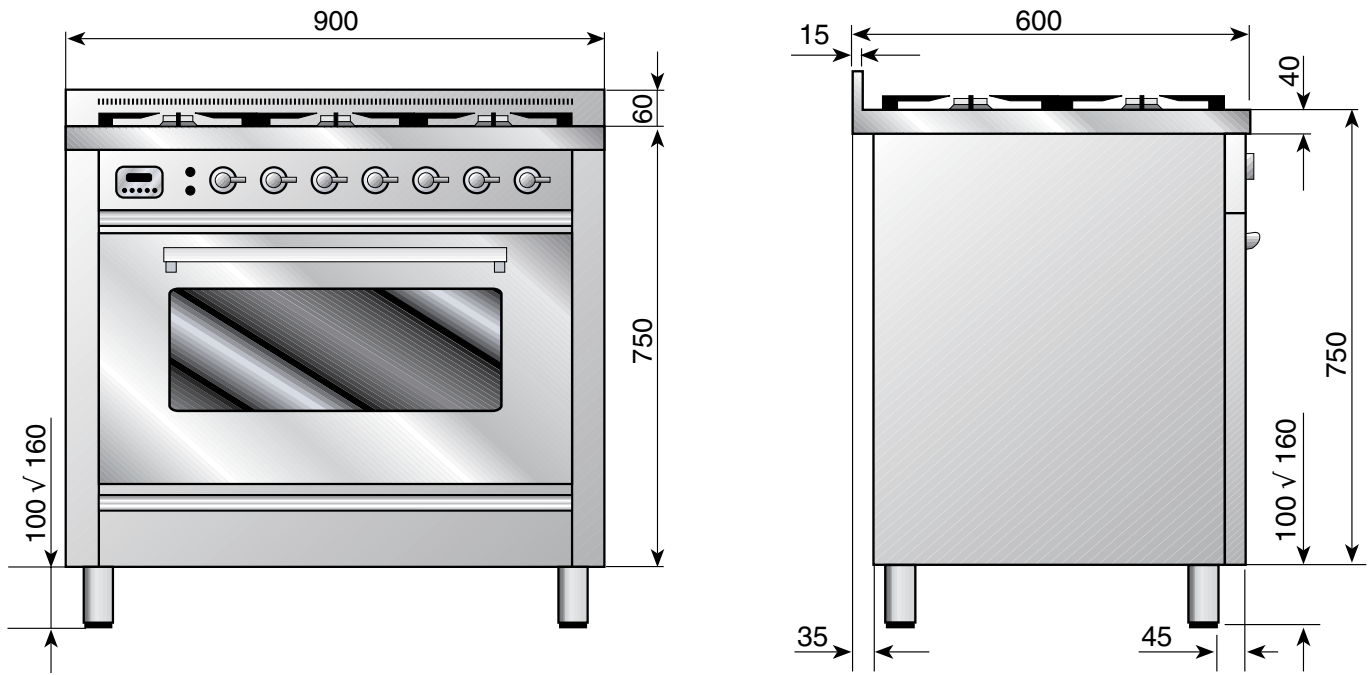

**Example: P90WMP**

## Dimensions for Models

Mod	60	70	80	90	100	120	150
Height	750	750	750	750	750	750	750
Width	600	700	800	900	1000	1200	1500
Depth	600	600	600	600	600	600	600
Leg Height	100/160	100/160	100/160	100/160	100/160	100/160	100/160

# INSTALLATION INSTRUCTIONS

## INSTALLATION

These technical instructions have been prepared for use by Authorised persons. This unit must only be installed by an Authorized person. The installation must be carried out by qualified personnel in accordance with the relevant requirements of the Gas Safety Regulations, the local Building Regulations.

## GAS CONNECTION

For MJ/H rating of the freestanding range refer to the rating plate that is located on the range. Gas-powered devices for home use, which are not connected to a conduit for the evacuation of combustion products, must not cause a concentration of carbon monoxide that could pose a health risk to the persons exposed in relation to the time of exposure. We recommend checking that the appliance is properly set up for the type of gas distributed. The connection to the gas pipes must be made in a workman like manner, in compliance with current standards that prescribe the installation of a safety tap at the end of the pipe. The Gas Connection is male ½”.

### Natural Gas

The appliance is factory set for Natural gas and is supplied with a 1kPa regulator that must be fitted to the gas supply to the appliance.

### ULP Gas

The ULPG gas pressure regulator must be set to provide a supply pressure of 2.75kPa conforming to standards regulations in force should be fitted. Fit the test point assembly to the gas connection when installing for use with ULPG Gas.

## GAS SUPPLY CONNECTION

This appliance is suitable for use with either a flexible connection or rigid copper connection. If installing the appliance with a flexible connection the flexible connection must be Australia Gas Association approved to class B of AS/NZS1869 as a minimum. Using a Plumbezy flexible hose, AGA approval number 6196, 10mm ID, class D and between 1-1.2m long in accordance with AG601 for a “high level connection”. During installation ensure that the flexible connection be located so as to prevent excessive operating temperatures affecting the hose. Under no circumstance is the temperature of the flexible connection to exceed its approved rating. The flexible connection should also be checked visually for any abrasion, defect or kinking and replaced or repositioned to prevent abrasion, kinking and permanent deformation if necessary. It is recommended that an isolating valve and union be fitted, to enable simple disconnection for servicing. These are to be in an accessible location. Ensure when fitting the elbow supplied with the appliance that the sealing washer is used to prevent gas leaks.

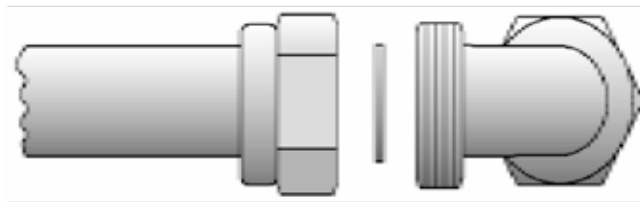

**Warning: Once the installation has been completed, check if there is any gas leakage by using soapy water or other suitable leak detection fluids.**

**DO NOT USE FLAMES TO CHECK ANY GAS LEAKAGES.**

## **BEFORE CONNECTING THE PLUG INTO THE POWER SOCKET, FOLLOW THESE INSTRUCTIONS**

The electrical supply for the upright cooker must be a 230 - 240 volt 50 Hz. The fuse and electrical wiring of the home / premises must support the load of the appliance. The wiring used to connect the electricity must be of a suitable size to carry the current load as specified on the product compliance plate. The range must be connected to a suitable earthed power supply of sufficient capacity to meet the power requirements as specified on the compliance plate. The power supply to the appliance must not be subject to direct heat and must be positioned to prevent it coming in contact with the rear cover of the range so that its temperature does not exceed 75°C

## **ANTI TILT BRACKET**

Two Anti tilt Brackets are supplied with the product (see pictured below). These brackets are to be secured to the rear wall 5 mm below the final height of the hob, when the product has been located and leveled, mark the rear wall with a pencil to confirm the height of the hob. Locate the studs in the rear wall and screw the anti tilt bracket so the top of the bracket is 5 mm below the hob line that has been marked on the rear wall. For brick or concrete walls use the wall plugs that are supplied. Once the brackets have been fixed in place, push the cooker back against the brackets then lift up the rear of the cooker so that the bracket will lock under the rear lip of the hob.



# ADAPTATION TO DIFFERENT TYPES OF GAS

The range is supplied as a natural gas unit and should not require any adjustment of the aeration. If the appliance is ordered and specified as a ULPG gas then it will be converted by Eurolinx prior to dispatch and should not require any adjustment to the aeration. Follow the steps below to convert to ULPG gas and to adjust the aeration of the burners. Remove the pan supports, caps and burners from the hob. Remove the screws that are securing the hob to the range and lift top up to gain access to the burner venturie.

Note: Some models do not have a one piece hob; these units will have securing screws around the outside edge of the spillage bowl that will need to be removed to gain access to the underside of the cooking hob

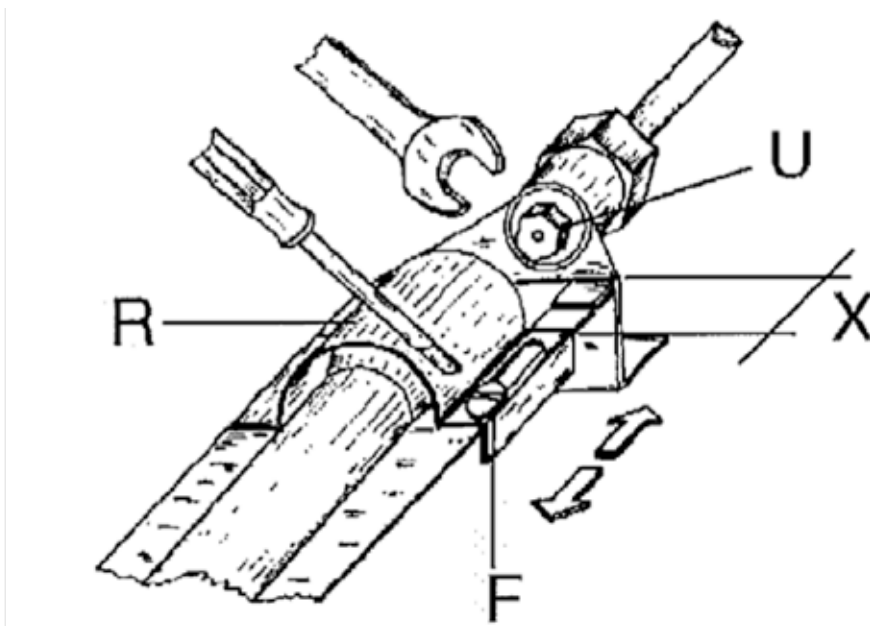

Remove screw "F" and remove air damper "R" Replace the Natural gas injector that is located at entry point of the venturie "U" with the ULPG injector. Use the chart below to identify the correct injector for each type of burner. Replace the air damper "R" and refit screw "F" leave lose to allow adjustment of aeration.

# INJECTOR & CAPACITY TABLE

BURNER	NATURAL GAS			ULPG		
	Inj	Mj/h	Kpa	Inj	Mj/h	Kpa
DUAL WOK	1.60/0.68	14/2.2	1.00	0.92/.040	13.1/2	2.75
SINGLE WOK	1.70	13.8	1.00	0.92	11.00	2.75
TITANIUM MODEL						
SINGLE WOK	1.60	12.5	1.00	0.92	11.00	2.75
LARGE	1.40	10.0	1.00	0.82	9.00	2.75
SIMMER PLATE	1.40	10.0	1.00	0.82	9.00	2.75
MEDIUM	1.10	6.2	1.00	0.68	6.00	2.75
FISH / TEPANYAKI	1.60	12.5	1.00	0.85	10.00	2.75
OVEN 60cm	1.30	8.5	1.00	0.75	6.80	2.75
GRILL 60cm	1.05	5.5	1.00	0.65	5.0	2.75
OVEN 90cm	2.00	17.5	1.00	1.2	18.60	2.75
GRILL 90cm	1.35	9.2	1.00	0.75	10.00	2.75

# AIR ADJUSTMENT

The air adjustment is to be carried out with the flame at the maximum, with a screwdriver loosen screw "F" and move the cylindrical sleeve "R" towards the injector to decrease the air, move it away from the injector to increase the air. Once the correct aeration is achieved tighten screw "F" to fix the position.

**TABLE 2** "X" mm (indicative)

Burner Type	Natural	ULPG
Medium	10mm	10mm
Large /Simmer	10mm	10mm
Single Wok	10mm	15mm- Fully Open
Titanium Single Wok	15mm Inner Fully Open	15mm- Fully Open
Dual Wok	Outer 10mm	Fully Open
Fish/Tepanyaki	10	5mm
Oven 90cm	4	20mm
Oven 60cm	6	20mm

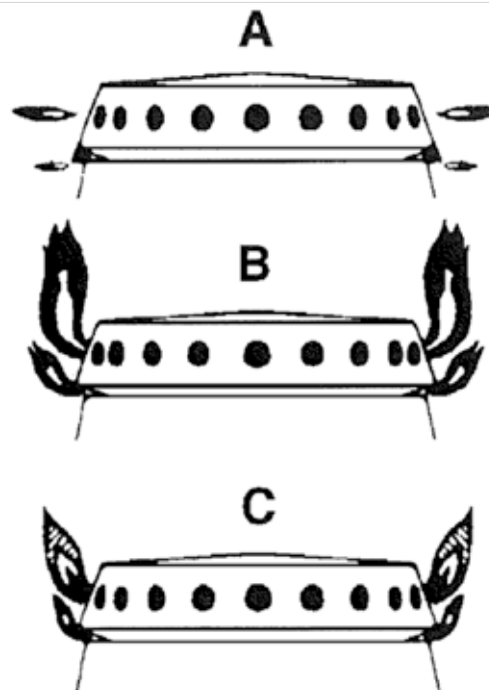
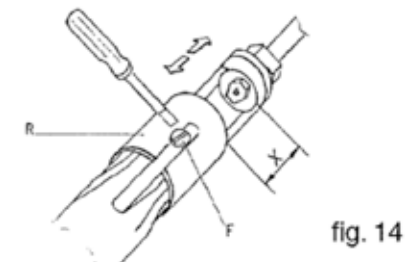
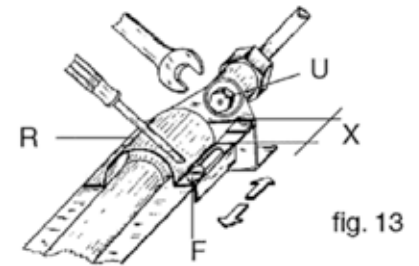

### Examples:

- A.** Flame with excess of air: it is small, tight and separated. Move forward the cylindrical sleeve R placed in front of the injector.
- B.** Flame with lack of air; it is floppy with yellow streaks. Move backward the cylindrical sleeve R placed in front of the injector.
- C.** Normal flame: its colour is light blue

When installing the appliance it is recommended to check that the burner minimum speed (Low Flame Setting) has been correctly adjusted. If it is necessary to change the type of gas, adjustment of the low flame setting must be completed by the installer. To adjust the minimum setting for the burners the following steps must be completed

## Minimum flow of valve cooking hob taps

- Switch on the burner and turn the control knob towards the minimum flow position;
- Remove the knob;
- Using a screwdriver, adjust the internal screw until the correct low flame is obtained, the screw is located just to the right of the shaft see figure 1
- Refit the knob.

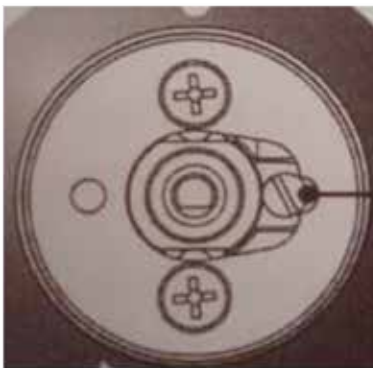

Figure 1

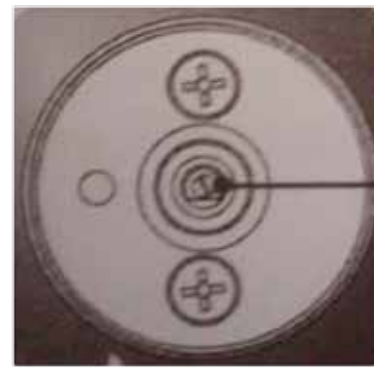

Figure 2

## Minimum flow of non-valved cooking hob taps

- Switch on the burner and turn the control knob towards the minimum flow position;
  - Remove the knob;
  - Insert a small screwdriver into the shaft of the gas valve and adjust the internal screw until the correct low flame is obtained; see figure 2
  - Refit the knob.
- 
- Unscrew the adjustment screw to increase the flow, or tighten it to reduce the flow.
  - The adjustment is correct when the low flame measures approximately 3 or 4 mm.
  - For ULPG the adjustment screw should be turned fully clockwise.
  - Make sure the flame does not go out when changing quickly from maximum flow and vice versa.

## ENSURE THE MINIMUM FLAME WILL NOT BE EXTINGUISHED BY AIR DRAUGHTS

# LOW FLAME ADJUSTMENT OF BURNERS

Check that the igniter for each burner successfully ignites the gas and that the burner remains alight. If an igniter fails to work or a burner fails to remain alight, first remove the plug from the electrical power outlet, and then check that all electrical connections are in place. If the hotplate fails to operate correctly, contact ILVE or their appointed agent for service (1300 MY ILVE 694 583).

When satisfied that the hotplate is operating correctly, instruct the customer in its safe operation. Ensure the customer understands fully by having them operate the hotplate in all its functions.

## Recommended Bypass (Low Flame Settings) Turns from fully in position

Burner Type	Natural	ULPG
Medium	1/2 - 5/8	Fully In
Large /Simmer	3/4	Fully In
Single Wok	1 3/8	Fully In
Titanium Single Wok	1 3/8	Fully In
Dual Wok	Inner 1/4 Outer 1/4	Inner 1/4 Outer 1/4
Fish	1/4	Fully In
Tepanyaki	3/4	Fully In
Oven 90cm	1/2	1/8
Oven 60cm	3/4	1/4

## Pressure Adjustment

First turn the gas off to the appliance. Remove the sealing screw from the regulator's test point at the rear of the appliance and place the hose of the Manometer onto it. Turn the gas on to the appliance and light the Wok Burner and Small Burner at maximum setting. Check the pressure and adjust at the regulator if necessary to the setting in the table on the last page or the Data plate. For ULPG Gas adjust at the regulator on the cylinder – Turn regulator adjusting screw clockwise increases pressure whilst anti-clockwise decreases pressure. Refit the test point sealing screw when finished.

## Electrical Equipment and Components

Electrical componentry is primarily located below the hob surface. Removal of the hob is straightforward by removing the control knobs, trivets, the burner caps and burner head assemblies and skirts. Using a flat bladed screwdriver remove the five screws, one in each corner of the hotplates left and right spillage bowls and one centrally located at the rear of the centre spillage bowl. Then lift the hob upwards. Replacement is a reversal of the above procedure. Care must be taken to ensure that no damage occurs to the spark ignition leads or the igniters. The electronic ignition pack is easily accessible for service or replacement below the hob centrally at the rear.

**ALWAYS ENSURE THAT THE POWER SUPPLY IS DISCONNECTED BEFORE SERVICING APPLIANCE**

## Gas Controls And Gas Manifold

Removal of the gas manifold is accomplished by removing the control knobs, the trivets, the burner caps and burner head assemblies and skirts. Using a flat bladed screwdriver remove the five screws, one in each corner of the hotplates left and right spillage bowls and one centrally located at the rear of the centre spillage bowl. Care must be taken to ensure that no damage occurs to the spark ignition leads, igniters or thermocouples (if fitted). Disconnect all ancillary gas piping. Remove the two securing screws from the positioning brackets at the front and also the securing bracket near the gas inlet point to the burner compartment. The gas manifold may then be extracted. Replacement is a reversal of the above procedure.

**ALWAYS ENSURE THAT THE GAS CONNECTION IS DISCONNECTED BEFORE SERVICING APPLIANCE**

## Conversion

If the appliance is to be used with another gas type, either ULPG Gas or Natural Gas, it must be converted by an Authorised Person. Contact Eurolinx Pty Ltd or their unathorized agent for details. For Natural and ULPG Gas Injector Sizes and Mj/H refer to tables on pages 39. The table above shows the appropriate injector sizes for either ULPG Gas or Natural Gas.

## NOTE

After conversion check the GAS PRESSURE and IGNITER OPERATION for the burners. If the hotplate cooker cannot be adjusted to perform correctly, or if there is excessive flame discolouration, yellow tipping or excessive noise contact ILVE or their authorised agent for advice. It is also recommended that this appliance be serviced at 12 months minimum intervals or sooner as required. Please also ensure that the duplicate data plate supplied be attached to the appliance or in an accessible place such as a cupboard for future reference.

**IMPORTANT:** Verify periodically the gas connection pipe and replace it as soon as any irregularity is present.

**IMPORTANT:** Correct positioning of the brass flame distributor is very important. For this purpose, ensure that the flame distributor tooth coincides with the notch on the aluminum base. To keep the flame distributor covers new, you are advised to remove them before lighting the flame.

# ILVE Recipes



Teppanyaki



Australian Breakfast



Marinated Seafood Skewers



Gourmet Pizza



Tasmanian Scallops Creole Style



Mustard Crusted Roast Leg of Lamb



Steamed Trout with Dill & Lemon



Grilled Lamb Cutlets & Vegetables



Rack of Lamb with Cheese & Semi-dried Tomato



Hazelnut Torte with Chocolate Ganache



PannaCotta with berries



More recipes are available on the ILVE operating Instructions DVD available for purchase at [shop.ilve.com.au](http://shop.ilve.com.au)



Serves 2



Preparation time:  
**10 minutes**



Cooking time:  
**10 minutes**

### Ingredients:

- 2 piece of trimmed steak (the cut of meat is up to you)
- 2 pieces of salmon steaks (or any other fish steak)
- ½ a capsicum
- 4 mushrooms
- ½ a bunch of rosemary leaves
- ½ an onion chopped
- 1 bunch of shallot tails
- 1 garlic clove
- Extra virgin olive oil
- Salt and pepper

**1**

Cut and trim vegetables place in deep bowl and mix in rosemary leaves garlic and extra virgin olive oil and mix well.

**2**

Pre heat teppanyaki plate on high for 10 minutes.

**3**

Brush steak and chicken with extra virgin olive oil and season to task with salt and pepper then add to the teppanyaki plate.

**4**

Once the steak and salmon require turning add the vegetables to the teppanyaki plate and work the vegetables until meat has finished cooking then serve.



# TEPANYAKI





# AUSTRALIAN BREAKFAST



Serves 2



Preparation time  
**10 minutes**



Cooking time  
**10 minutes**

## Ingredients:

4 eggs  
4 sausages  
6 rashers or bacon  
2 large mushrooms sliced  
2 tomatoes halved

①

Heat teppanyaki plate up for 10 minutes then spray plate with extra virgin olive oil.

②

Place sausages on teppanyaki plate and cook for 5 minutes turning as needed.

③

Add bacon, mushroom, tomatoes and cook for a further 5 minutes.

④

Add eggs onto the plate and remove all food from the teppanyaki plate when the eggs have cooked.



## ILVE COOKING TIP

To avoid splatter and trap heat, use ILVE's teppanyaki dome cover accessory.



Serves 4



Preparation time  
**20 minutes**



Cooking time  
**5 minutes**

**Ingredients:**

1kg seafood, salmon,  
green prawns and octopus

½ cup (125ml) olive oil

Juice 1 lemon

2 cloves garlic, crushed

1 tablespoon parsley or  
dill, chopped

Freshly ground pepper, to taste

Bamboo skewers, soaked  
in water

**1**

Cut salmon into cubes, peel  
prawns and cut tentacles off  
octopus, leaving on tails.

**2**

Mix together oil, lemon, parsley  
or dill and pepper to taste in a  
bowl, making marinade.

**3**

Add seafood and marinate for  
about 15 minutes.

**4**

Heat teppanyaki plate or grill  
plate to hot.

**5**

Place skewers on heated plate  
and cook for approximately 5  
minutes, turning frequently.

**6**

Serve immediately.

**ILVE COOKING TIP**

Do not overcook seafood,  
generally once it has lost  
its opaque appearance the  
seafood is ready.



# MARINATED SEAFOOD SKEWERS





# GOURMET PIZZA



Serves 3-4



Preparation time

**1 hour**



Cooking time

**15 minutes**

## Ingredients:

Pizza Dough

3 cups plain flour or  
bakers flour

Salt

30g dried yeast

1 cup (250ml) warm water

3 tablespoons olive oil

## Toppings

A selection of your  
favourite pizza toppings

Tomato sauce

Mozzarella cheese

**1**

Sift flour and salt into a large mixing bowl and sprinkle dried yeast over flour. Make a well in the centre of the flour, salt and yeast mix then pour in water and oil. Stir in flour, combining to make soft dough. Transfer dough onto a lightly floured board and knead to a smooth ball. Place dough back into a clean, oiled bowl. Cover with plastic wrap and leave to rise in a warm place until the dough has doubled in size.

**2**

Preheat oven (Mode 9) to hot 220°C. Once this temperature is reached turn oven to (Mode 1).

**3**

Remove dough from bowl and return to lightly floured board. Knead to form a ball. Cut ball in half and flatten half into a large circle. Transfer to a lightly greased baking tray or pizza stone.

**4**

Top with tomato sauce, mozzarella cheese and a selection of your favourite toppings.

**6**

Bake in oven for 15 minutes or until crisp and browned.





Serves 4-6



Preparation time  
10 minutes



Cooking time  
5-8 minutes

### Ingredients:

12 fresh scallops in half shell  
1 lime or lemon

#### Crumb Mixture

100g butter, softened  
1 cup dry fresh breadcrumbs  
2 teaspoons cajun spice  
1 teaspoon tomato paste  
2 egg yolks  
2 teaspoons sweet chilli sauce  
Dash brandy, optional

❶

Preheat grill to high (Mode 6).

❷

Place scallops in shell on  
baking tray.

❸

Combine all crumb mixture  
ingredients to make a smooth  
paste. Either pipe or spoon  
mixture onto each shell, making  
sure scallop meat is fully  
covered.

❹

Place baking tray under grill  
and cook for 5-8 minutes, or until  
golden brown.

❺

Serve with either lime or  
lemon wedges.

### ILVE COOKING TIP

If mixture looks too dry add  
extra butter before topping on  
scallops.



# TASMANIAN SCALLOPS CREOLE STYLE



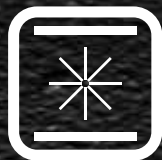

# MUSTARD CRUSTED ROAST LEG OF LAMB



Serves 6-8



Preparation time  
**10 minutes**



Cooking time  
**90 minutes**



## Ingredients:

- 1½ - 2kg leg of lamb
- 1 large clove of garlic, slivered
- 3 tablespoons seeded mustard
- 1 teaspoon sweet soy sauce

❶

Preheat oven (Mode 9) to 160°  
C.

Once this temperature is reached  
turn oven to (Mode 7).

❷

Pierce lamb with a knife to make  
slits. Place garlic slivers into slits.

❸

Mix together seeded mustard  
and soy sauce, making a paste  
and spread paste evenly over  
the leg of lamb.

❹

Place lamb in a baking dish.  
Pour a small amount of water  
into bottom of baking dish.  
(This helps to keep leg  
of lamb moist).

❺

Place baking dish into centre of  
oven and cook for 90 minutes.

❻

Serve with roast vegetables.

## ILVE COOKING TIP

Place roast into centre of  
oven, evenly spaced between  
the top and bottom elements.



Serves 6-8



Preparation time  
10 minutes



Cooking time  
15 minutes

**Ingredients:**

- 1 500g trout, cleaned and scaled
- 6-8 cups (1.75-2L) fish stock or water
- Sprigs of dill
- 1 lemon, sliced
- 1 spanish onion, sliced

❶

Place trout, dill, lemon slices and spanish onion slices onto a perforated tray into fish kettle.

❷

Carefully pour in 1-2 cups of water or stock in fish kettle and lower tray with trout carefully into fish kettle, cover with lid.

❸

Steam the fish with a gentle simmer for approximately 10-15 minutes. Test fish after 10 minutes by using a fork to flake the thickest part of the trout. It is ready when it flakes easily.

**ILVE COOKING TIP**

Check fish with point of knife by lifting the flesh, fish will be ready when the opaque appearance of the flesh is gone.

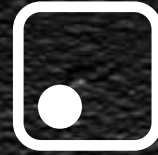

# STEAMED TROUT WITH DILL & LEMON





# GRILLED LAMB CUTLETS & VEGETABLES



Serves 2



Preparation time  
10 minutes



Cooking time  
5-8 minutes



## Ingredients:

6 extra thick french trimmed lamb cutlets  
Selection of your favourite vegetables, for example capsicum, spanish onion and zucchini  
Extra virgin olive oil  
Salt and pepper

①

Season cutlets with salt and pepper.

②

Slice vegetables, toss in oil and season with salt and pepper.

③

Heat grill plate or teppanyaki to hot.

④

Place on seasoned cutlets and cook for about 8 minutes, turning occasionally.

⑤

Remove to warmed serving plate and cover with foil.

⑥

Add vegetables to grill and cook for 3 minutes or until tender. Serve cutlets with vegetables.

## ILVE COOKING TIP

Try this dish using different herbs, spices and marinades. Take care with sugar based marinades as they tend to burn quickly.



Serves 2



Preparation time  
**15 minutes**



Cooking time  
**35 minutes**

### Ingredients:

1 rack lamb, french trim  
6 sundried tomatoes  
50g tasty cheese, small pieces  
Sprigs of rosemary  
4 thin slices pancetta ham  
1½ (375ml) cups rich red wine sauce  
or gravy

❶

Preheat oven (Mode 9) to 250°C.  
Once this temperature is reached  
turn oven to (Mode 2).

❷

With knife or skewer make an  
incision along the lamb fillet just  
below the bone.

❸

Make the incision wider by  
stretching cavity with your fingers.

❹

Finely chop rosemary and mix  
with marinade oil of sundried  
tomatoes, gently rub over the  
outside of lamb rack and through the  
cavity made in lamb.

❺

Insert sundried tomatoes and cheese  
into cavity, plug ends with  
a sundried tomato to stop the  
cheese from melting out during  
cooking process.

❻

Lay pancetta slices over meaty part  
of lamb rack and place lamb into  
preheated oven, middle shelf for  
5 minutes.

❼

Reduce heat to 160° C and cook for  
a further 30 minutes.

❽

Remove lamb from oven, allowing to  
rest for at least 5 minutes. Cut the  
meat between fingers and serve with  
mashed potatoes, vegetables and  
red wine sauce or gravy.

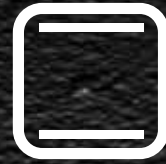

# RACK OF LAMB WITH CHEESE & SEMI-DRIED TOMATO



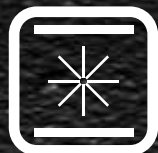

# HAZELNUT TORTE WITH CHOCOLATE GANACHE



Serves 6-8



Preparation time  
**20 minutes**



Cooking time  
**35-45 minutes**

## Ingredients:

- 6 eggs
- $\frac{3}{4}$  cup caster sugar
- 1 cup ground hazelnuts
- $\frac{3}{4}$  cup white breadcrumbs
- 1 teaspoon plain flour
- Chocolate Ganache
- 300g dark cooking chocolate
- $\frac{1}{2}$  cup (125ml) fresh cream
- Hazelnuts to decorate

**1**

Preheat oven (Mode 9) to 150°C. Once this temperature is reached turn oven to (Mode 7).

**2**

Separate eggs, placing whites in bowl to side. Beat egg yolks until thick and pale. Gradually beat in  $\frac{1}{2}$  cup sugar, then nuts and breadcrumbs and continue beating until ingredients are well combined.

**3**

Whisk egg whites until they begin to foam. Gradually add remaining sugar and beat until mixture forms peaks.

**4**

Add half the egg white mixture into the hazelnut mixture and gently fold in. Sprinkle mixture with flour and fold in remaining egg white mixture.

**5**

Line and butter a 25cm spring form tin and pour cake mixture into tin. Bake cake for 35-45 minutes, until cake shrinks away from sides of tin. Remove cake from oven and remove sides of cake tin. Allow cake to cool.

**6**

Chocolate Ganache.

Melt chocolate and cream in a double saucepan stirring to combine. Allow ganache to cool.

**7**

Once cake is cooled carefully cut horizontally to make two even layers. Spread half cooled ganache over one half of cold cake. Replace the top of cake and cover with remaining ganache. Decorate with whole hazelnuts.





Serves 4



Preparation time  
**10 minutes**



Cooking time  
**5 minutes**

**Ingredients:**

1  $\frac{3}{4}$  cups double cream  
4 tablespoons caster sugar  
Vanilla  
2 teaspoons gelatine  
Fresh berries or your favourite  
fruit for serving

**1**

Put cream and sugar in a  
saucepan, stirring until sugar  
dissolves. Bring to the boil,  
then turn down and simmer  
for 3 minutes.

**2**

Add a few drops of vanilla.

**3**

Put a small amount of the cream  
mixture into a bowl, add gelatine into  
mixture to dissolve and then pour  
in remaining cream mixture. Stir to  
combine thoroughly.

**4**

Pour mixture into 4 x  $\frac{1}{2}$  cup moulds,  
cover and refrigerate until set.

**5**

To unmould wrap each panna cotta  
in a cloth dipped in hot water and  
tip upside down onto a serving  
plate. Shake gently to release from  
mould. Repeat process if this does  
not work.

**6**

Serve with either berries or your  
favourite fruit.

**ILVE COOKING TIP**

Strain mixture gently  
before tipping into moulds to  
remove all gelatin lumps.

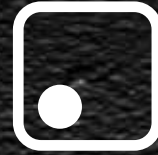

# PANNACOTTA WITH BERRIES



# GUARANTEE

The Manufacturer declines any liability in case of direct or indirect damages caused by an incorrect installation, changes, poor servicing or incorrect use.

Eurolinx Pty Ltd  
48-50 Moore Street Leichhardt NSW 2040  
T: 1300 MY ILVE (694 563)  
F: 02 8569 4699  
ACN: 001 473 347

## SERVICE

**All Service calls must be booked through ILVE's Service and Warranty Department Service must only be completed by Ilve Authorised Service Agents Phone 1300 85 64 11 Updated 01/01/2013**

# iWarranty

REGISTER YOUR WARRANTY ONLINE NOW

GO TO: [warranty.ilve.com.au/registration](http://warranty.ilve.com.au/registration)

# NOTES

**Eurolinx Pty Limited A.B.N. 50 001 473 347  
trading as ILVE ("ILVE")**

**Office:**

**48-50 Moore Street, Leichhardt N.S.W 2040**

**Post:**

**Locked Bag 3000, Annandale, N.S.W 2038**

**P: 1300 856 411**

**WARRANTY REGISTRATION**

Your ongoing satisfaction with your ILVE product is important to us. We ask that you complete the enclosed Warranty Registration Card and return it to us so that we have a record of the ILVE product purchased by you. Alternatively, you can now register your warranty online at <http://warranty.ilve.com.au/registration>

**PRIVACY**

ILVE respects your privacy and is committed to handling your personal information in accordance with the National Privacy Principles and the Privacy Act 1988 (Cth). A copy of the ILVE Privacy Policy is available at [www.ilve.com.au](http://www.ilve.com.au). ILVE will not disclose any personal information set out in the Warranty Registration Card ("Personal Information") without your consent unless required by:

1. law;
2. any ILVE related company;
3. any service provider which provide services to ILVE or assist ILVE in providing services (including repair and warranty services) to customers. Our purpose in collecting the Personal Information is to keep a record of the ILVE product purchased by you, in order to provide a better warranty service to you in the unlikely event that there is a problem with your ILVE product. ILVE may contact you at any one or more of the addresses, email addresses or telephone numbers set out in the Warranty Registration Card. Please contact ILVE on 1300 694 583 should you not wish to be contacted by ILVE.

**WARRANTY**

**1. Warranty**

ILVE warrants that each ILVE product will remain, for a period of twenty four (24) months computed from the date of purchase of the ILVE product, free from defects arising in the manufacture of the ILVE product ("Warranty"). Except for consumer guarantees set out in the Competition and Consumer Act 2010 (Cth) ("Act"), ILVE does not make any further warranties or representations in relation to ILVE products.

**2. What is not Covered by the Warranty.**

The Warranty does not apply if an ILVE product

is defective by a factor other than a defect arising in the manufacture of the ILVE product, including but not limited to:

- (a) damage through misuse (including failure to maintain, service or use with proper care), neglect, accident or ordinary wear and tear (including deterioration of parts and accessories and glass breakage);
- (b) use for purpose for which the ILVE product was not sold or designed;
- (c) use or installation which is not in accordance with any specified instructions for use or installation;
- (d) use or operation after a defect has occurred or been discovered;
- (e) damage through freight, transportation or handling in transit (other than when ILVE is responsible);
- (f) damage through exposure to chemicals, dusts, residues, excessive voltage, heat, atmospheric conditions or other forces or environmental factors outside the control of ILVE;
- (g) repair, modification or tampering by the purchaser or any person other than ILVE, an employee of ILVE or an authorised ILVE service contractor\*;
- (h) use of parts, components or accessories which have not been supplied or specifically approved by ILVE.
- (i) damage to surface coatings caused by cleaning or maintenance using products not recommended in the ILVE product handbook provided to the purchaser upon purchase of the ILVE product;
- (j) damage to the base of an electric oven due to items having been placed on the base of the oven cavity or covering the base, such as aluminium foil (this impedes the transfer of heat from the element to the oven cavity and can result in irreparable damage); or
- (k) damages, dents or other cosmetic imperfections not affecting the performance of the ILVE in respect of an ILVE product purchased as a "factory second" or from display

The Warranty does not extend to light globes used in ILVE products.

**3. Domestic Use**

Each ILVE product is made for domestic use. This Warranty may not extend to ILVE products used for commercial purposes.

**4. Time for Claim under the Warranty**

You must make any claim under this Warranty within twenty eight (28) days after the occurrence of an event which gives rise to a claim pursuant to the Warranty, by booking a service call on the telephone number below.

Continued over...

## 5. Proof of Purchase

Customers must retain proof of purchase in order to be eligible to make a warranty claim in respect of an ILVE product.

## 6. Claiming under the Warranty

Customers will bear the cost of claiming under this Warranty unless ILVE determines the expenses are reasonable, in which case the customer must claim those expenses by providing written evidence of each expense to ILVE at the address on the Warranty Registration Card.

## 7. Statutory Rights

(a) These terms and conditions do not affect your statutory rights.

(b) The limitations on the Warranty set out in this document do not exclude or limit the application of the consumer guarantees set out in the Act or any other equivalent or corresponding legislation in the relevant jurisdiction where to do so would:

(i) contravene the law of the relevant jurisdiction; or

(ii) cause any part of the Warranty to be void.

(c) ILVE excludes indirect or consequential loss of any kind (including, without limitation, loss of use of the ILVE product) and (other than expressly provided for in these terms and conditions) subject to all terms,

conditions and warranties implied by custom, the general law, the Act or other statute.

(d) The liability of ILVE to you for a breach of any express or non-excludable implied term, condition or warranty is limited at the option of ILVE to:

(i) replacing or repairing the defective part of the ILVE product;

(ii) paying the cost of replacing or repairing the defective part of the ILVE product;

(iii) replacing the ILVE product; or

(iv) paying the cost of replacing the ILVE product.

(e) Our goods come with guarantees that cannot be excluded under the Australian Consumer Law. You are entitled to a replacement or refund for a major failure and for compensation for any other reasonably foreseeable loss or damage. You are also entitled to have the goods repaired or replaced if the goods fail to be of acceptable quality and the failure does not amount to a major failure.

## 8. Defects

Any part of an ILVE product deemed to be defective and replaced by ILVE is the property of ILVE. ILVE reserves the right to inspect and test ILVE products in order to determine the extent of any defect and the validity of a claim under the Warranty.

\*For your closest ILVE authorised service agent please contact ILVE on 1300 856 411 or visit <http://support.ilve.com.au/> or

Email: [ilveservice@eurolinx.com.au](mailto:ilveservice@eurolinx.com.au)

**ALL SERVICE CALLS MUST BE BOOKED THROUGH THE ILVE SERVICE AND WARRANTY DEPARTMENT ON 1300 856 411**

**01032013**

## Warranty Card tear off

WARRANTY REGISTRATION CARD  
01012013

Please complete and send to ILVE at: REPLY PAID 83617  
LEICHHARDT NSW 2040

Last Name:		First Name:	
Address:			
State:	Postcode:	Email:	
Home Phone:		Mobile:	
Purchase Date:    /    /		(Please attach proof of purchase to validate warranty)	

MODEL NUMBER	SERIAL NUMBER <small>(if you cannot locate the serial number please call ILVE on 1300 85 64 11)</small>
1	
2	
3	
4	

01032013

## TROUBLESHOOTING

PROBLEM	ANSWER
<b>COOKTOPS</b>	
My burners will not ignite	<ul style="list-style-type: none"> <li>• Check to see if the brass burners are placed correctly into the aluminium base. This is very important as it will ensure the flame holes line up with the ignition post and spark. It will also ensure correct combustion when alight.</li> <li>• Does your ILVE cooktop have flame failure devices fitted? Ensure burners are located correctly as above. When burner is lit, ensure knob is firmly depressed for 5 to 10 seconds.</li> </ul>
Does your ILVE cooktop have flame failure devices fitted?	Ensure burners are located correctly as above. When burner is lit, ensure knob is firmly depressed for 5 to 10 seconds. If new, ensure knobs are firmly fitted, check by pushing knobs down firmly with the palm of your hand.
My ignition continually sparks	This may be due to a liquid spill over, which can cause moisture to enter into ignition micro switches under knobs. Spraying liquid type cleaners can also create a problem. If this does occur, the cooktop should be turned off at power point and left to dry out. Removing all knobs and using a hair dryer on the control panel, will assist the drying out process.
All the igniters spark at the same time when lighting	This is normal and how they are designed to operate.
The knob is loose on shaft	Knob retaining spring clip has come out. This does not require a service technician and can be replaced by the customer. Please contact your ILVE state office, who will arrange for a clip to be sent to you.
The burner is extinguished when the cupboards or drawers are opened or shut	In this case, the underside of the cooktop needs to be totally sealed off from the surrounding cupboards or drawers.
The flame tips are yellow causing the pots to blacken on the underside	The gas type may be incorrect contact your installer and have him check the gas type and the injector size and or the aeration needs adjusting see pages 40-41
The low flame is still to high	The low flame bypass screw needs to be adjusted contact your installer and have him adjust the low flame setting as per the specification on page 41.

PROBLEM	ANSWER
<b>OVENS</b>	
How do I change the door seals?	Please note: the replacement of oven door seals does not require a service technician. Door seals are easily replaced, please contact your ILVE state office, who will arrange for a replacement to be sent. If out of warranty please contact the ILVE spare parts department on 02 8569 4666 or <a href="mailto:spareparts@eurolinx.com.au">spareparts@eurolinx.com.au</a>
My oven will not turn on but the clock is illuminated (digital type clock)	This problem can occur after a power interruption or when the power is first turned on to the appliance. The display will show an "A" and the clock needs to be reset. This can be done by pressing both pot buttons (  ) simultaneously. The time can be adjusted by pressing the +/- buttons. For full instructions refer to the operating manual supplied with the appliance or available on line at <a href="http://www.ilve.com.au">www.ilve.com.au</a>
Oven will not turn on (Analogue type clock)	For the oven to work manually, the hand symbol must be displayed in the little window on clock. For full instructions refer to the operating manual supplied with the appliance or available on line at <a href="http://www.ilve.com.au">www.ilve.com.au</a>
My oven smokes when turned on	This is a natural occurrence and is caused by the self-clean burning off process. A good tip: leave the oven on at a high temperature for 10 minutes after removing cooked food. This will burn off any splatter and prevent the oil from going cold. It will then start to burn off when oven is next turned on. Please note: all ovens will occasionally require to be dismantled and cleaned internally, even if self-clean liners are fitted. Do not use oven cleaner on self-clean liners. For full instructions refer to the operating manual supplied with the appliance or available on line at <a href="http://www.ilve.com.au">www.ilve.com.au</a>
My oven gets too hot externally	Check that the correct ventilation has been allowed. See illustrations of ventilation requirements in the installation book. Please note that being an oven, the external panels will warm up after the oven has been on for over an hour, at high temperatures. This is normal heat transfer; the panels can heat up to around 60°C.
I am unable to remove the light cover to replace the globe	Cover the glass with e.g. an old tea towel and use multi-grip pliers to lightly grip the cover and undo it turning anti-clockwise.
The oven light is not working	All current model ovens require the function knob to be pushed in/out to turn light on or off.

01032013

You can now find us on:



[facebook.com/ILVEappliances](https://facebook.com/ILVEappliances)



[twitter.com/ILVE\\_appliances](https://twitter.com/ILVE_appliances)



[youtube.com/ILVEappliances](https://youtube.com/ILVEappliances)



[livewithilve.com](http://livewithilve.com)



Australia National Telephone Number 1300 MYILVE (694 583)  
New Zealand Telephone Number 0508 458 369

ILVE showrooms are open daily from 9am-5pm and Saturdays 10am-4pm  
(WA by appointment only on Saturdays)

[ilve.com.au](http://ilve.com.au)

NSW & ACT (Head Office)  
48-50 Moore Street  
Leichhardt  
F 02 8569 4699

VIC, TAS & SA  
1211 Toorak Road  
Camberwell  
F 03 9809 2155

QLD  
1/42 Cavendish Road  
Coorparoo  
F 07 3397 0850

WA & NT  
Unit 10/55 Howe Street  
Osborne Park  
F 08 9201 9188

New Zealand  
PO Box 11.160  
Sockburn Christchurch  
F 03 344 5906

