

**deco**<sup>™</sup> | **Deco XE70 Pro**  
Superior Mesh Wi-Fi, Everywhere

Wi-Fi 6E  HomeShield  
 works with Google Home

# User Guide

## AXE4900 Whole Home Mesh Wi-Fi 6E Router



# Contents

|                        |   |
|------------------------|---|
| About This Guide ..... | 1 |
| Appearance .....       | 2 |
| Set Up Your Deco ..... | 3 |
| Troubleshooting .....  | 7 |
| Authentication .....   | 8 |

# About This Guide

This guide provides a brief introduction to AXE4900 Whole Home Mesh Wi-Fi 6E System and regulatory information. Features available in Deco may vary by model and software version. Deco availability may also vary by region or ISP. All images, steps, and descriptions in this guide are only examples and may not reflect your actual Deco experience.

## Conventions

In this guide, the following conventions are used:

| Convention       | Description  |
|------------------|--|
| Deco             | Stands for Deco Whole Home Mesh Wi-Fi System/ Unit.  |
| <u>Underline</u> | Hyperlinks are in teal and underlined. You can click to redirect to a website or a specific section.     |
| Teal             | Key information appears in teal, including management page text such as menus, items, buttons and so on. |
| 📌 Note:          | Ignoring this type of note might result in a malfunction or damage to the device.                        |
| 💡 Tips:          | Indicates important information that helps you make better use of your device.                           |

## More Info

- Specific product information can be found on the product page at <https://www.tp-link.com>.
- A Technical Community is provided for you to discuss our products at <https://community.tp-link.com>.
- Our Technical Support contact information can be found at the [Help](#) center of the Deco app and the [Contact Technical Support](#) page at <https://www.tp-link.com/support>.

## Speed/Coverage/Device Quantity Disclaimer

Maximum wireless signal rates are the physical rates derived from IEEE Standard 802.11 specifications. Actual wireless data throughput and wireless coverage, and quantity of connected devices are not guaranteed and will vary as a result of network conditions, client limitations, and environmental factors, including building materials, obstacles, volume and density of traffic, and client location.

## MU-MIMO Disclaimer

Use of MU-MIMO requires clients to also support MU-MIMO.

## IoT Compatibility Disclaimer

IoT compatibility refers only to smart devices that can be controlled via the Deco app. Other wireless devices can still connect to Deco for normal Wi-Fi use.

## Seamless Roaming Disclaimer

Clients need to support 802.11k/v/r and may require additional set up. Performance may vary depending on the client device.

# Appearance

Each Deco has an LED that changes color according to its status, three RJ-45 Ethernet ports, a power slot, and a Reset button.

See the explanation below:

Tip: The product label can be found at the bottom of the product.

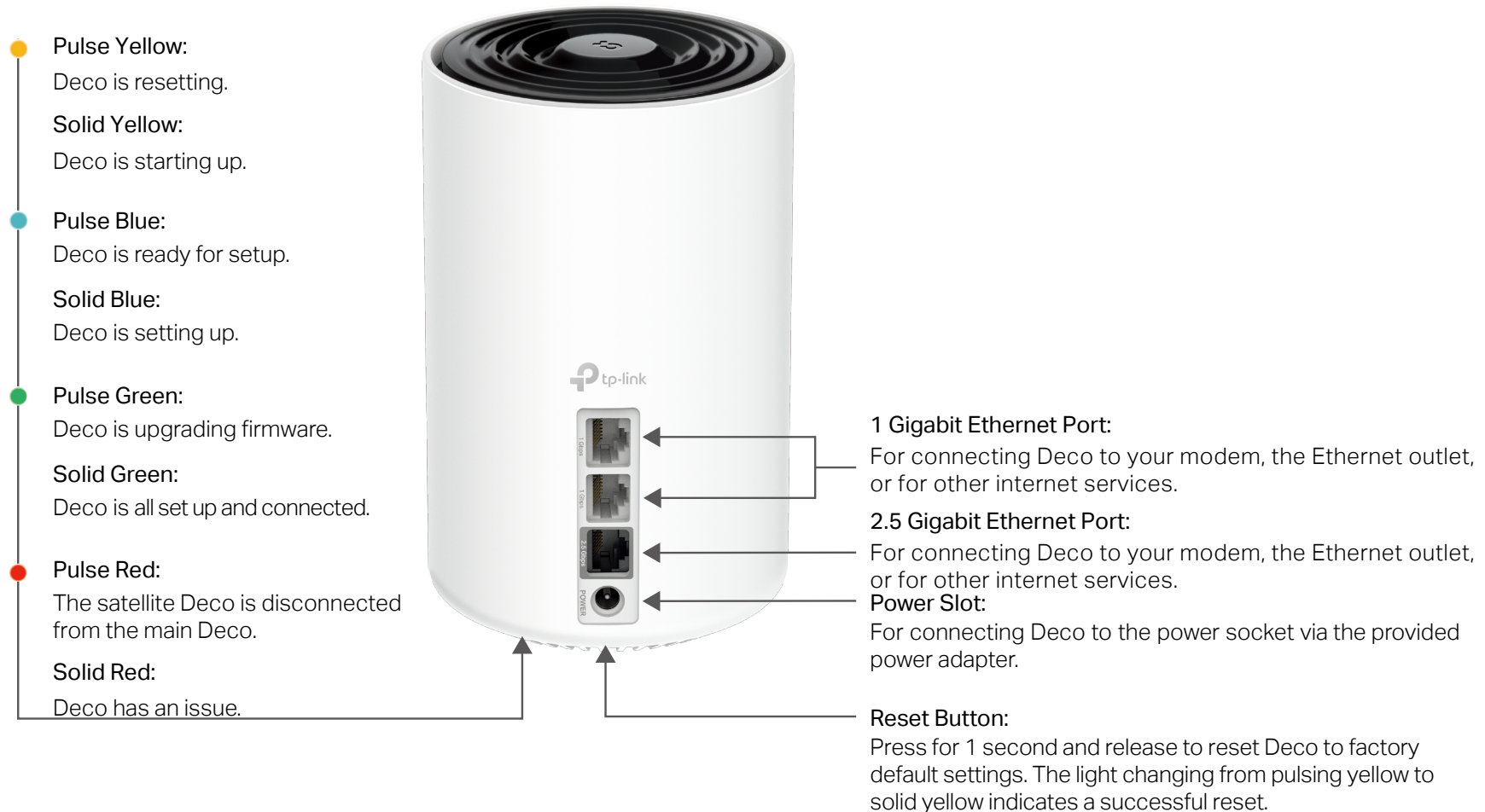

# Set Up Your Deco

First let's start by setting up the Deco network. Get the TP-Link Deco app for iOS or Android, then follow the app to walk through the setup.

## 1. Get the Deco app

Scan the QR code below or go to Google Play or the App Store to download the Deco app. Install the app on your Android or iOS smartphone or tablet.



or

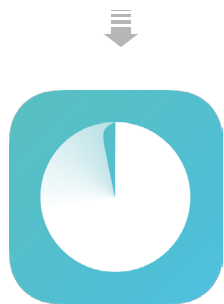

## 2. Log in or sign up with TP-Link ID

Open the app and log in with your TP-Link ID. If you don't have a TP-Link ID, create one first.

**Note:** If you forgot your login password, tap [Forgot Password?](#). The app will help you reset your password.

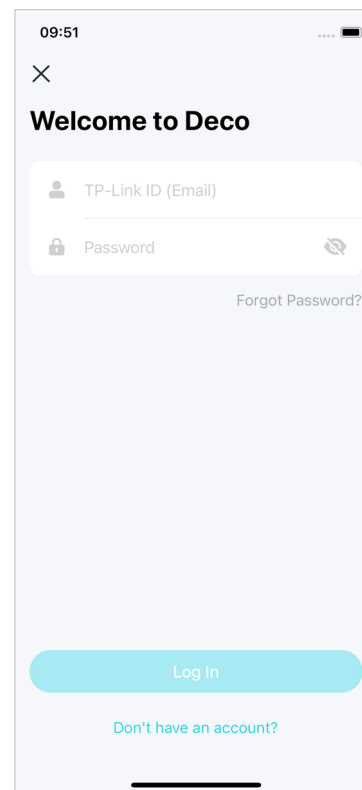

## 3. Select your Deco model

Search for and select your Deco model. If you have more than one Deco model, tap the question below the search box to check how to maximize the overall network.

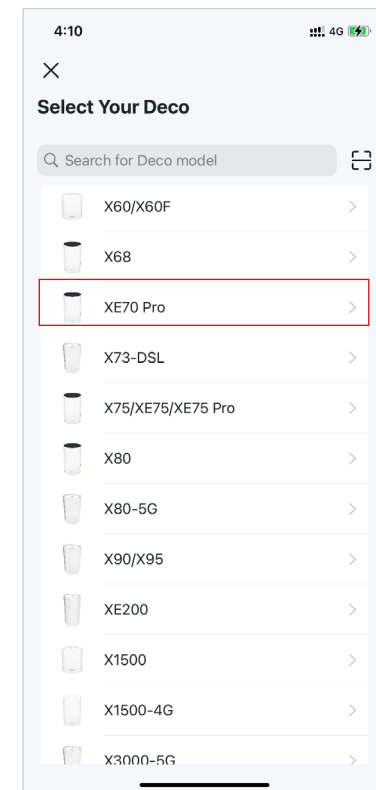

#### 4. Scan your Deco's product label

Scan the QR code on the product label at the bottom of your Deco for a quicker setup. You can also set it up manually.

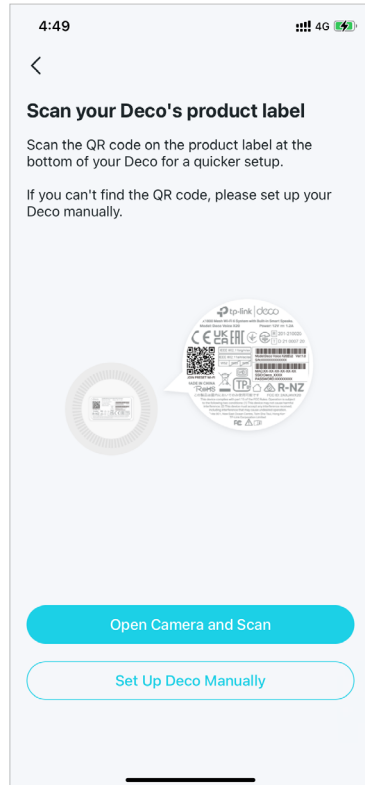

#### 5. Plug in your Deco

Power off your modem. Connect your Deco to the modem and power them both on.

If you don't have a modem, connect your Deco directly to the Ethernet outlet.

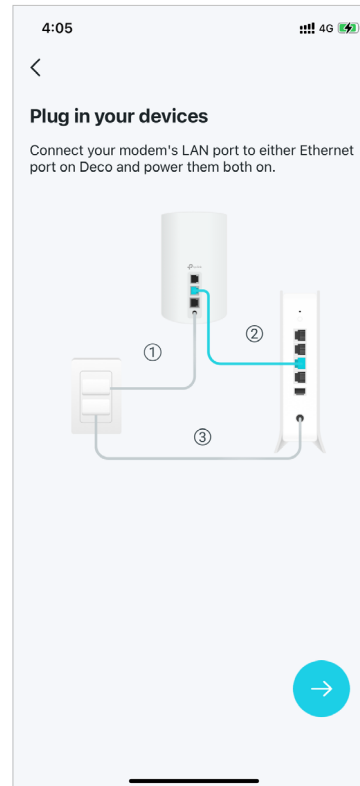

#### 6. Wait until Deco's LED pulses blue

Wait until your Deco's LED pulses blue, then your phone/tablet will connect to the Deco's default Wi-Fi automatically.

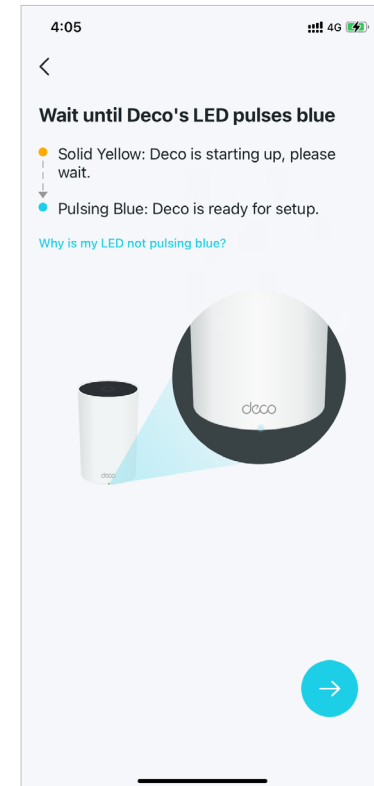

## 7. Specify your Deco's location

Select or custom a location for your Deco. The location will be used as the name of your Deco.

12:38

✕

### Where have you placed this Deco?

The location will be used as this Deco's name.

- Bedroom
- Hallway
- Kitchen
- ✓ Living Room
- Main Bedroom
- Office
- Study
- Custom

Next

## 8. Connect your Deco to the internet

Select the internet connection type and enter the information. If you are not sure, contact your internet service provider.

12:38

✕

### Connect your Deco to the internet

Enter the information provided by your ISP (internet service provider). If you are unsure, contact your ISP.

Internet Connection Type  
Dynamic IP >

IPTV/VLAN Settings Off >

[Need to change MAC address?](#)

Next

## 9. Create your Wi-Fi network

Set a network name and a password. These will be the name and password you use to connect your devices to Wi-Fi.

12:39

✕

### Create your Wi-Fi Network

This will be the name and password you'll use to access your network. Your password must be at least 8 characters.

Network Name

Password

We recommend using a combination of letters, numbers, and symbols for your password.

Next

## 10. Create your 6GHz Wi-Fi network

Set a network name and a password. These will be the name and password you use to connect your devices to the 6GHz Wi-Fi.

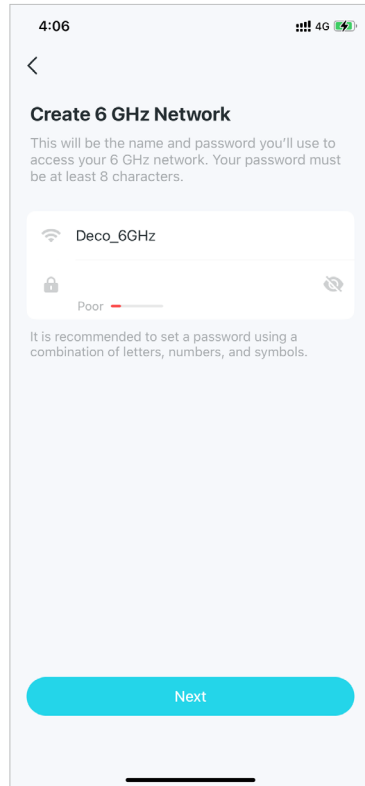

## 11. Connect to your Wi-Fi network

Connect your phone/tablet to the Deco's Wi-Fi.

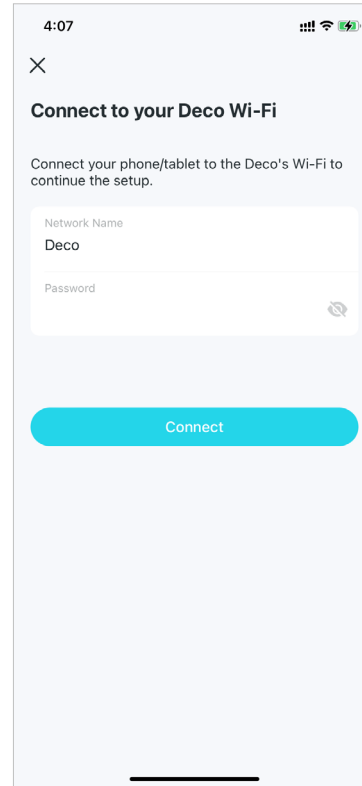

## 12. Setup complete

Your Deco network is now up. You can connect your devices to the Deco network. Plug in the other included Decos, and they will automatically join the network within 2 minutes.

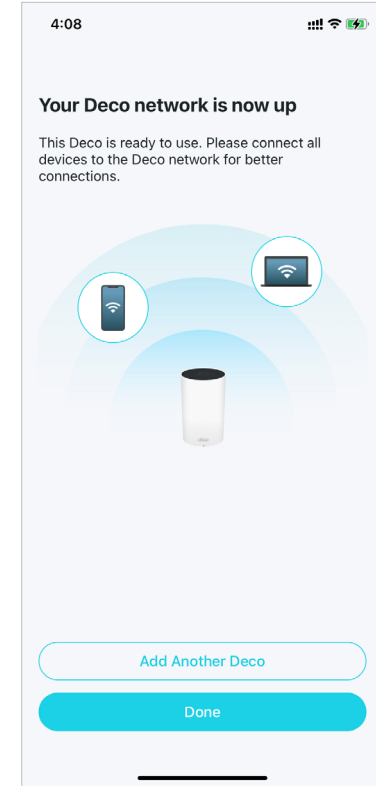

# Troubleshooting

Solutions to common problems during setup or use are provided here for reference. Follow the steps and the provided link below to diagnose and solve problems you might experience with your Deco.

If problems still exist, contact us: <https://www.tp-link.com/support>

## **Q1. What should I do if I fail to configure the main Deco and get stuck on “We couldn't find Deco”?**

Refer to the guide <https://www.tp-link.com/support/faq/2239/> or follow the video <https://youtu.be/2HYuEYS9XJM>

## **Q2. What should I do if I fail to configure the satellite Deco and get stuck on “We couldn't find another Deco”?**

Refer to the guide <https://www.tp-link.com/support/faq/1447/> or follow the video <https://youtu.be/iVgDzoo16T4>

## **Q3. What should I do if I fail to configure the main Deco and get stuck on “Testing Internet Connection”?**

Refer to the guide <https://www.tp-link.com/support/faq/2239/>

Refer to the video <https://youtu.be/OSUrGdWH-i0>

## **Q4. What should I do if my wireless devices cannot connect to Deco?**

Refer to the guide <https://www.tp-link.com/support/faq/2718/>

## **Q5. What should I do if Deco suddenly lost internet access?**

Refer to the guide <https://www.tp-link.com/support/faq/2428/>

## **Q6. How can I find a suitable spot for my Deco?**

Refer to the guide <https://www.tp-link.com//support/faq/1446/>

## **Q7. What can I do if the Deco app isn't working properly?**

Refer to the guide <https://www.tp-link.com/support/faq/1456/>

# Authentication

## FCC Compliance Information Statement



**Product Name:** AXE4900 Whole Home Mesh Wi-Fi 6E System

**Model Number:** Deco XE70 Pro

| Component Name     | Model       |
|--------------------|-------------|
| I.T.E Power Supply | T120200-2B4 |

### Responsible party:

#### TP-Link USA Corporation

Address: 10 Mauchly, Irvine, CA 92618

Website: <http://www.tp-link.com/us/>

Tel: +1 626 333 0234

Fax: +1 909 527 6804

E-mail: [sales.usa@tp-link.com](mailto:sales.usa@tp-link.com)

This equipment has been tested and found to comply with the limits for a Class B digital device, pursuant to part 15 of the FCC Rules. These limits are designed to provide reasonable protection against harmful interference in a residential installation. This equipment generates, uses and can radiate radio frequency energy and, if not installed and used in accordance with the instructions, may cause harmful interference to radio communications. However, there is no guarantee that interference will not occur in a particular installation. If this equipment does cause harmful interference to radio or television reception, which can be determined by turning the equipment off and on, the user is encouraged to try to correct the interference by one or more of the following measures:

- Reorient or relocate the receiving antenna.
- Increase the separation between the equipment and receiver.
- Connect the equipment into an outlet on a circuit different from that to which the receiver is connected.

- Consult the dealer or an experienced radio/ TV technician for help.

This device complies with part 15 of the FCC Rules. Operation is subject to the following two conditions:

1. This device may not cause harmful interference.
2. This device must accept any interference received, including interference that may cause undesired operation.

Any changes or modifications not expressly approved by the party responsible for compliance could void the user's authority to operate the equipment.

Note: The manufacturer is not responsible for any radio or TV interference caused by unauthorized modifications to this equipment. Such modifications could void the user's authority to operate the equipment.

### **FCC RF Radiation Exposure Statement**

This equipment complies with FCC RF radiation exposure limits set forth for an uncontrolled environment. This device and its antenna must not be co-located or operating in conjunction with any other antenna or transmitter.

To comply with FCC RF exposure compliance requirements, this grant is applicable to only Mobile Configurations. The antennas used for this transmitter must be installed to provide a separation distance of at least 20 cm from all persons and must not be co-located or operating in conjunction with any other antenna or transmitter.

FCC regulations restrict operation of this device to indoor use only. The operation of this device is prohibited on oil platforms, cars, trains, boats, and aircraft, except that operation of this device is permitted in large aircraft while flying above 10000 feet. Operation of transmitters in the 5.925-6.425GHz band is prohibited for control of or communications with unmanned aircraft systems.

We, TP-Link USA Corporation, has determined that the equipment shown as above has been shown to comply with the applicable technical standards, FCC part 15. There is no unauthorized change is made in the equipment and the equipment is properly maintained and operated.

Issue Date: 2024-01-25

## FCC Compliance Information Statement



**Product Name:** I.T.E POWER SUPPLY

**Model Number:** T120200-2B4

**Responsible party:**

**TP-Link USA Corporation**

Address: 10 Mauchly, Irvine, CA 92618

Website: <http://www.tp-link.com/us/>

Tel: +1 626 333 0234

Fax: +1 909 527 6804

E-mail: [sales.usa@tp-link.com](mailto:sales.usa@tp-link.com)

This equipment has been tested and found to comply with the limits for a Class B digital device, pursuant to part 15 of the FCC Rules. These limits are designed to provide reasonable protection against harmful interference in a residential installation. This equipment generates, uses and can radiate radio frequency energy and, if not installed and used in accordance with the instructions, may cause harmful interference to radio communications. However, there is no guarantee that interference will not occur in a particular installation. If this equipment does cause harmful interference to radio or television reception, which can be determined by turning the equipment off and on, the user is encouraged to try to correct the interference by one or more of the following measures:

- Reorient or relocate the receiving antenna.
- Increase the separation between the equipment and receiver.
- Connect the equipment into an outlet on a circuit different from that to which the receiver is connected.
- Consult the dealer or an experienced radio/ TV technician for help.

This device complies with part 15 of the FCC Rules. Operation is subject to the following two conditions:

1. This device may not cause harmful interference.
2. This device must accept any interference received, including interference that may cause undesired operation.

Any changes or modifications not expressly approved by the party responsible for compliance could void the user's authority to operate the equipment.

We, TP-Link USA Corporation, has determined that the equipment shown as above has been shown to comply with the applicable technical standards, FCC part 15. There is no unauthorized change is made in the equipment and the equipment is properly maintained and operated.

Issue Date: 2024-01-25

## Canadian Compliance Statement

This device complies with Industry Canada license-exempt RSS standard(s). Operation is subject to the following two conditions:

1. This device may not cause interference.
2. This device must accept any interference, including interference that may cause undesired operation of the device.

Le présent appareil est conforme aux CNR d'Industrie Canada applicables aux appareils radio exempts de licence. L'exploitation est autorisée aux deux conditions suivantes :

1. l'appareil ne doit pas produire de brouillage;
2. l'utilisateur de l'appareil doit accepter tout brouillage radioélectrique subi, même si le brouillage est susceptible d'en compromettre le fonctionnement.

### Caution:

The device for operation in the band 5150–5250 MHz is only for indoor use to reduce the potential for harmful interference to co-channel mobile satellite systems;

DFS (Dynamic Frequency Selection) products that operate in the bands 5250- 5350 MHz.

### Avertissement:

Le dispositif fonctionnant dans la bande 5150-5250 MHz est réservé uniquement pour une utilisation à l'intérieur afin de réduire les risques de brouillage préjudiciable aux systèmes de satellites mobiles utilisant les mêmes canaux;

Les produits utilisant la technique d'atténuation DFS (sélection dynamique des fréquences) sur les bandes 5250- 5350 MHz.

### Radiation Exposure Statement:

This equipment complies with IC radiation exposure limits set forth for an uncontrolled environment. This equipment should be installed and operated with minimum distance 20cm between the radiator & your body.

### Déclaration d'exposition aux radiations:

Cet équipement est conforme aux limites d'exposition aux rayonnements IC établies pour un environnement non contrôlé. Cet équipement doit être installé et utilisé avec un minimum de 20 cm de distance entre la source de rayonnement et votre corps.

ISED regulations restrict operation of this device to indoor use only. The operation of this device is prohibited on oil platforms, cars, trains, boats, and aircraft, except that operation of this device is permitted in large aircraft while flying above 10000 feet. Operation of transmitters in the 5.925-7.125 GHz band is prohibited for control of or communications with unmanned aircraft systems.

Les réglementations ISED limitent le fonctionnement de cet appareil à une utilisation en intérieur uniquement. L'utilisation de cet appareil est interdite sur les plates-formes pétrolières, les voitures, les trains, les bateaux et les avions, sauf que l'utilisation de cet appareil est autorisée dans les avions long courrier en vol au-dessus de 10000 pieds. L'exploitation d'émetteurs dans la bande 5,925-7,125 GHz est interdite pour le contrôle ou les communications avec des systèmes d'avions sans pilote.

## Industry Canada Statement

CAN ICES-3 (B)/NMB-3(B)



## Korea Warning Statements:

당해 무선설비는 운용중 전파혼신 가능성이 있음.

## NCC Notice & BSMI Notice:

注意!

取得審驗證明之低功率射頻器材，非經核准，公司、商號或使用者均不得擅自變更頻率、加大功率或變更原設計之特性及功能。

低功率射頻器材之使用不得影響飛航安全及干擾合法通信；經發現有干擾現象時，應立即停用，並改善至無干擾時方得繼續使用。

前述合法通信，指依電信管理法規定作業之無線電通信。

低功率射頻器材須忍受合法通信或工業、科學及醫療用電波輻射性電機設備之干擾。

應避免影響附近雷達系統之操作。

## 安全諮詢及注意事項

- 請使用原裝電源供應器或只能按照本產品注明的電源類型使用本產品。

- 清潔本產品之前請先切斷電源。請勿使用液體、噴霧清潔劑或濕布進行清潔。
- 注意防潮，請勿將水或其他液體潑灑到本產品上。
- 插槽與開口供通風使用，以確保本產品的操作可靠並防止過熱，請勿堵塞或覆蓋開口。
- 請勿將本產品置放於靠近熱源的地方。除非有正常的通風，否則不可放在密閉位置中。
- 不要私自拆開機殼或自行維修，如產品有故障請與原廠或代理商聯繫。

限用物質含有情況標示聲明書

|   |  |   |                      |  |  |  |
|---|--|---|----------------------|--|--|--|
| 設備名稱：<br>Equipment name:<br>AXE4900 Whole Home Mesh Wi-Fi 6E System |  | 型號（型式）：<br>Type designation (Type)<br>Deco XE70 Pro |                      |  |  |  |
| 單元<br>Unit  | 限用物質及其化學符號<br>Restricted substances and its chemical symbols |   |                      |  |  |  |
|   | 鉛<br>Lead<br>(Pb)  | 汞<br>Mercury<br>(Hg)                                | 鎘<br>Cadmium<br>(Cd) | 六價鉻<br>Hexavalent<br>chromium<br>(Cr <sup>+6</sup> ) | 多溴聯苯<br>Polybrominated<br>biphenyls<br>(PBB) | 多溴二苯醚<br>Polybrominated<br>diphenyl ethers<br>(PBDE) |
| PCB   | ○  | ○   | ○                    | ○  | ○  | ○  |
| 外殼  | ○  | ○   | ○                    | ○  | ○  | ○  |
| 電源供應器   | —  | ○   | ○                    | ○  | ○  | ○  |
| 其他及其配件  | —  | ○   | ○                    | ○  | ○  | ○  |



備考1. 超出0.1 wt %” 及 “超出0.01 wt %” 系指限用物質之百分比含量超出百分比含量基準值。

Note 1: “Exceeding 0.1 wt %” and “exceeding 0.01 wt %” indicate that the percentage content of the restricted substance exceeds the reference percentage value of presence condition.

備考2. “○” 系指該項限用物質之百分比含量未超出百分比含量基準值。

Note 2: “○” indicates that the percentage content of the restricted substance does not exceed the percentage of reference value of presence.

備考3. “—” 系指該項限用物質為排除項目。

Note 3: The “—” indicates that the restricted substance corresponds to the exemption.



Продукт сертифіковано згідно с правилами системи УкрСЕПРО на відповідність вимогам нормативних документів та вимогам, що передбачені чинними законодавчими актами України.



#### Safety Information

- Keep the device away from water, fire, humidity or hot environments.
- Do not attempt to disassemble, repair, or modify the device. If you need service, please contact us.
- Do not use damaged charger or USB cable to charge the device.
- Do not use any other chargers than those recommended.
- Do not use the device where wireless devices are not allowed.
- Adapter shall be installed near the equipment and shall be easily accessible.
- Use only power supplies which are provided by manufacturer and in the original packing of this product. If you have any questions, please don't hesitate to contact us.
- Operating Temperature: 0°C~40°C (32°F~104°F)









- This product uses radios and other components that emit electromagnetic fields. Electromagnetic fields and magnets may interfere with pacemakers and other implanted medical devices. Always keep the product and its power adapter more than 15 cm (6 inches) away from any pacemakers or other implanted medical devices. If you suspect your product is interfering with your pacemaker or any other implanted medical device, turn off your product and consult your physician for information specific to your medical device.













Please read and follow the above safety information when operating the device. We cannot guarantee that no accidents or damage will occur due to improper use of the device. Please use this product with care and operate at your own risk.



## Explanation of the symbols on the product label

Symbols may vary from products.

Note: The product label can be found at the bottom of the product and its I.T.E. power supply.

| Symbol  | Explanation                                 |
|---|---|
|    | Class II equipment                          |
|    | Class II equipment with functional earthing |
|    | Alternating current                         |
|    | DC voltage                                  |
|  | Polarity of output terminals                |
|  | Indoor use only                             |
|  | Dangerous voltage                           |
|  | Caution, risk of electric shock             |

| Symbol  | Explanation               |
|---|---------------------------|
|    | Energy efficiency Marking |
|    | Protective earth          |
|    | Earth                     |
|    | Frame or chassis          |
|    | Functional earthing       |
|    | Caution, hot surface      |
|    | Caution                   |
|    | Operator's manual         |
|   | Stand-by                  |
|  | "ON"/"OFF" (push-push)    |
|  | Fuse                      |
|  | Fuse is used in neutral N |

| Symbol  | Explanation  |
|---|--|
|  | <p>RECYCLING</p> <p>This product bears the selective sorting symbol for Waste electrical and electronic equipment (WEEE). This means that this product must be handled pursuant to European directive 2012/19/EU in order to be recycled or dismantled to minimize its impact on the environment.</p> <p>User has the choice to give his product to a competent recycling organization or to the retailer when he buys a new electrical or electronic equipment.</p> |
|  | <p>Caution, avoid listening at high volume levels for long periods</p>   |
|  | <p>Disconnection, all power plugs</p>  |
| <p>m</p>  | <p>Switch of mini-gap construction</p>   |
| <p>μ</p>  | <p>Switch of micro-gap construction (for US version)<br/>Switch of micro-gap / micro-disconnection construction (for other versions except US)</p>   |
| <p>ε</p>  | <p>Switch without contact gap (Semiconductor switching device)</p>   |