

Dear Customer,

Thank you for choosing this quality product from ASKO.

We hope it will meet your expectations and fulfill your needs for many years to come. Scandinavian design combines clean lines, everyday functionality, and high quality. These are key characteristics of all our products and the reason they are greatly appreciated throughout the world.

To get the most out of your new machine, we recommend that you read the operating instructions before using it. The operating instructions also include information on how you can help protect the environment.



Operating Instructions

Washing Machine
W8844XL W

WARNING: Read the instructions before using the machine.

CONTENTS

IMPORTANT SAFETY INSTRUCTIONS	3	CARE AND CLEANING	14
Child safety	3	Cleaning the trap and the drainage pump	14
Overflow guard function	4	Cleaning the detergent compartment	14
TRANSPORT/WINTER STORAGE	4	Cleaning the outside of the machine	14
PACKING MATERIAL	4	Cleaning the inside of the machine to avoid unpleasant smells	14
Disposal	4	Rinse holes under the agitator	14
ADVICE AND TIPS BEFORE WASHING	5	If you have hard water	15
LAUNDRY LABEL SYMBOLS	5	TROUBLESHOOTING	16
Sorting your laundry	7	The washer door will not open	16
Clothing	7	Opening the door in an emergency:	16
Coloured cotton	7	After power failure	16
Unbleached linen	7	Wet washing still in the machine	16
Wool	7	Error messages	16
Save time and energy	7	INSTALLATION	18
High water level	7	Leveling the machine	18
Economy and efficiency	7	Water supply connection	18
Detergents	7	Electrical installation	18
Dyeing fabrics	8	Grounding instructions	18
Liquid detergents	8	Freestanding installation	19
Detergents	8	Limited warranty – residential appliances	19
Recommended powder detergents	8	Items excluded from warranty	19
Detergent amounts based on water hardness	8	Disclaimer of implied warranties	20
Amount of detergent to use	8	PROGRAM CHART	21
USING YOUR WASHING MACHINE	9	QUICK GUIDE	24
Add detergent and fabric softener	9		
Program selection	10		
Selecting options	11		
During the programme	12		
SETTINGS	13		
How to choose the settings	13		
Making a selection	13		
Saving a selection	13		
You can change the following settings	13		



⚠ IMPORTANT SAFETY INSTRUCTIONS

Do you need this Use&Care Guide in Spanish? Log on to www.askona.com/customer-care to download.

¿Necesita estas Instrucciones de uso y cuidado en español? Entre en www.askona.com/customer-care y descárguela.

SAVE THESE INSTRUCTIONS FOR FUTURE REFERENCE

⚠ WARNING!

To reduce the risk of fire, electric shock, or injury to persons when using your appliance, follow basic precautions, including the following:

- Read all instructions before using the appliance.
- Do not run appliance while you are out of the home.
- Do not wash or dry articles that have been previously cleaned in, washed in, soaked in, or spotted with gasoline, dry-cleaning solvents, cooking oils, or other flammable or explosive substances because they give off vapors that could ignite or explode.
- Do not allow children to play on or in the appliance. Close supervision of children is necessary when the appliance is used near children.
- Before the appliance is removed from service or discarded, remove the door to the washing compartment.
- Do not reach into the appliance if the drum is moving.
- Do not install or store this appliance where it will be exposed to the weather.
- Do not tamper with controls.
- Do not repair or replace any part of the appliance or attempt any servicing unless specifically recommended in the user-repair instructions or in published user-repair instructions that you understand and have the skills to carry out.
- Do not add gasoline, dry-cleaning solvents, or other flammable or explosive substances to the wash water. These substances give off vapors that could ignite or explode.
- Under certain conditions, hydrogen gas may be produced in a hot water system that has not been used for 2 weeks or more. **HYDROGEN GAS IS EXPLOSIVE.** If the hot water system has not been used for such a period, before using a washing machine or combination washer-dryer, turn on all water faucets and let the water flow from each for several minutes. This will release any accumulated hydrogen gas. As the gas is flammable, do not smoke or use an open flame during this time.
- This machine can be used by children aged 8 and over, as well as by people with reduced physical capacity, mental ability, or memory loss or lacking experience and knowledge. These individuals must be supervised when using the machine or receive instructions on how to use the machine and understand the risks that may arise.
- Cleaning and maintenance of the machine must not be performed by unsupervised children.

⚠ WARNING!

This appliance must be properly grounded.

This manual does not cover every possible condition and situation that may occur. Use common sense and caution when installing, operating, and maintaining any appliance.

CHILD SAFETY

- Children must be watched to ensure they do not play with the machine.
- Always close the washer door and start the program immediately after adding detergent.
- Do not allow small children to use or play with the washing machine.
- Store detergent and fabric softener out of the reach of children.
- Laundry detergents are corrosive, so always keep them out of reach of children.
- Should a child swallow detergent, give plenty to drink immediately, i.e., one or two glasses of milk or water. Do not try to induce vomiting. Seek medical advice immediately: The National Poison center phone number is 1-800-222-1222.
- Always turn the power off to the machine when it is not in use.
- Always keep small children away from the machine when it is open. There may be some detergent residue left inside the machine.
- If laundry detergent gets in someone's eyes, rinse them with plenty of water for at least 15 minutes.

Activate Child-safe Start (button lock)

You can activate the Child-safe Start option (button lock) to prevent children from starting the washing machine (see the Settings section).

Activate child safety catch (for detergent compartment)

On the inside of the detergent compartment is a child safety catch.

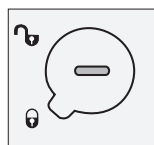

Activated child safety catch

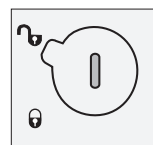

Inactivated child safety catch





IMPORTANT SAFETY INSTRUCTIONS

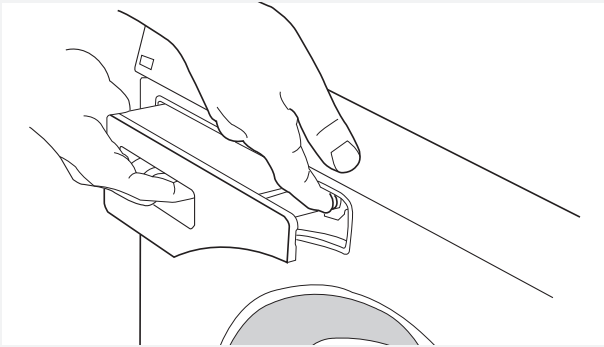

When the child safety catch is activated, you must press the release button to pull out the detergent compartment.

INSTALLATION

- Conduct installation and connection in accordance with the separate installation instructions.
- Water and electricity installations, if required, must be carried out by qualified professionals.
- Remove any transport protection devices before using the machine. See the separate installation instructions.

OVERFLOW GUARD FUNCTION

If the water level in the machine rises above normal, the overflow guard function begins to pump water out and shuts off the water intake. If the water level has not dropped within 60 seconds, the program is terminated.

TRANSPORT/WINTER STORAGE

If the machine is to be transported or stored in unheated premises where the temperature can fall below freezing, do as follows:

- Empty the filter and the drain pump. See the “Care and cleaning” chapter.
- Shut off the water to the washing machine, loosen the supply hose to the intake valve, and let the water run out from the valve and hose.
- After emptying the pump, a small amount of water may remain in the machine. This does not affect quality or damage the machine.

PACKING MATERIAL

Please sort waste materials in accordance with local guidelines.

DISPOSAL







When the machine has reached the end of its service life and is to be disposed of, it should immediately be made unusable by removing the door to the washing compartment. Contact your local authorities for information about where your machine should be disposed of and recycled in the proper way. The machine is manufactured and labeled for recycling.

SAVE THESE INSTRUCTIONS FOR FUTURE REFERENCE

ADVICE AND TIPS BEFORE WASHING

LAUNDRY LABEL SYMBOLS

Examples of washing instructions and recommended programs. Always follow the washing instructions for each garment.

Laundry labels	Material	Program
	Heavily soiled cotton, linen, white, and light-colored items.	Sani 140 °F (60 °C) to 203 °F (95 °C)
	Normally soiled cotton, linen, cotton/polyester. Light and dark-colored garments.	Quick 140 °F (60 °C)
	Polyester, polyamide, elastane, acrylic. Light and dark-colored garments.	PermaPress 104 °F (40 °C)
	Acrylic, viscose, modal, acetate.	Everyday Wear 104 °F (40 °C)
	Silk and very delicate items	PermaPress 86 °F (30 °C)
	Wool and other very delicate garments	Wool/hand Wash 86 °F (30 °C) to 104 °F (40 °C)

ADVICE AND TIPS BEFORE WASHING

WASH CYCLE



Normal wash cycle



Permanent Press or Wrinkle Resistant setting



Gentle/Delicate setting



Hand wash only



Do not wash



Do not wring. Hang dry, drip dry, or dry flat

WASH WATER TEMPERATURE



Maximum water temp
200° F/95° C



Maximum water temp
160° F/70° C



Maximum water temp
140° F/60° C



Maximum water temp
120° F/50° C



Maximum water temp
105° F/40° C



Maximum water temp
85° F/30° C

BLEACH INSTRUCTIONS



Any bleach when needed



Only non-chlorine bleach



Do not bleach

DRY CLEAN SYMBOL



Dry clean only

TUMBLE DRY CYCLE



Machine dry



Normal setting



Permanent Press or Wrinkle Resistant setting



Gentle or Delicate setting



Do not tumble dry

TUMBLE DRY HEAT SETTING



Any heat



High heat



Medium heat



Low heat



No heat/Air fluff

SPECIAL DRYING INSTRUCTIONS



Line dry or hang to dry



Drip dry (do not spin or wring)



Dry flat



Dry in shade

IRONING INSTRUCTIONS



Ironing is necessary



High temperature setting



Medium temperature setting



Low temperature setting



Do not iron or press with heat



Iron without steam

ADVICE AND TIPS BEFORE WASHING

Here are some tips that may help you before washing.

SORTING YOUR LAUNDRY

Sort items according to:

- how soiled they are
- colour
- material

CLOTHING

- 1 Close zippers and Velcro straps so they won't damage fabrics.
- 2 New colored items may contain excess dye and should therefore be washed separately the first few times.
- 3 Turn delicate items inside out. This reduces the risk of burling and fading.
- 4 Empty pockets and wash them inside out if possible.

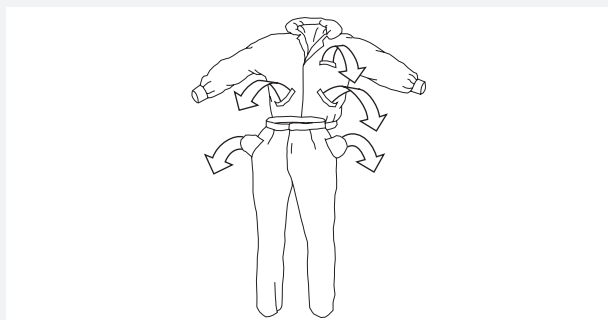

LAUNDRY LABELS

Look at the item's laundry label. The table below shows suitable wash programs for different materials and wash loads. Using modern washing machines and detergents, such as compact detergents, you can usually wash at lower temperatures. It is a good idea to use trial and error to find out what produces the best results.

COLOURED COTTON

Colored cotton garments labeled with the washing instruction 140 °F (60 °C) must be washed at 140 °F (60 °C) initially to remove any excess dye. Failure to observe this advice could lead to color bleeding. Use detergent without bleach to preserve the color of the fabric.

UNBLEACHED LINEN

Unbleached linen fabrics should be washed at 140 °F (60 °C) using detergent without bleach or optical brighteners. Heavily soiled linen can be washed at higher temperatures, but not too often as the heat may destroy the sheen and strength of the linen.

WOOL

These fabrics are labeled for either machine wash or hand wash. The machine's Wool/hand Wash program is at least as gentle as washing by hand.

Wool is especially sensitive to processes such as washing. If you do not wish to spin dry, you can squeeze out the water using terrycloth towels. In this case, select No spin. However, most garments can withstand a short spin. Choose a short spin by selecting a spin speed of 800 rpm or less.

RAYON FIBRES AND SYNTHETIC FIBRES

Materials made of rayon fibers, such as viscose, and some synthetic fibers are very delicate and require much space to avoid wrinkling. Only half fill the drum when washing and choose a spin speed of 800 rpm or lower.

NOTE!

Viscose and acetates are fragile when wet.

SAVE TIME AND ENERGY

Use the Color program to save time and energy. This program has a shorter main wash than White, but is often sufficient for lightly soiled laundry.

HIGH WATER LEVEL

If you want more water for the main wash and rinses, you can use the High Water Level option. High Water Level is used automatically in the Wool/hand Wash program.

ECONOMY AND EFFICIENCY

You can save a lot of energy by not using higher temperature programs than necessary.

- Select Quick if you just need to freshen up shirts or exercise clothes, for example. This will save both water and energy.
- If you select a fast spin speed, this reduces energy consumption when drying in a tumble dryer or drying cabinet.
- Always wash with a full load when using the Sani, Color, and White programs.
- Avoid pre-washing. Modern machines and detergents clean effectively without pre-washing. Pre-washing is only necessary for heavily soiled laundry.

DETERGENTS

Eco-labeled detergents are less harmful to the environment. Detergent overdosing does not give better washing results; it merely causes a greater impact on the environment. Try to use less detergent, and increase only if you are not satisfied with the results.



ADVICE AND TIPS BEFORE WASHING

DYEING FABRICS

If you want to dye fabrics in the machine, select the Color program with the Super Rinse option. Select the temperature according to the dye manufacturer's recommendations. Choose a low spin speed if the fabric to be dyed is a blended material, such as polyester/cotton.

NOTE!

Add the dye directly to the washing drum – not to the detergent compartment. After dyeing, you should run the machine empty using the same program. Use the normal amount of detergent.

NOTE!

Due to environmental concerns, we discourage the use of strong chemicals.

When using agents for bleaching or stain removal, there is a risk of rust (corrosion) and discoloration of the machine.

LIQUID DETERGENTS

We don't recommend liquid detergents because they tend to produce more suds than powder detergents when used in water temperatures of 150° F or higher. If you should try a liquid detergent, start with a very small amount, such as 1 to 2 tablespoons. Also, liquid detergent can be used for all programs without prewash, so add it into the main wash compartment.

DETERGENTS

Laundry detergents are available in low-, normal- and high-sudsing formulas. A detergent's ability to clean is not relative to the amount of suds it produces. Excess suds in a front-loading washer actually interfere with the cleaning because they cushion the tumbling action. Also, high-sudsing detergents are more difficult to completely rinse out.

The use of anything other than a low-sudsing detergent can cause severe oversudsing, which could cause suds to backup through the detergent compartment and run down the front of the washer onto the floor. If oversudsing occurs, run the wash through one or more rinse programs until all items are thoroughly rinsed. Remove the laundry then run the washer through a Normal wash program to get rid of any remaining detergent.

We recommend that you don't use bleach in your ASKO washer. The tumbling wash action, temperature control options, extended wash times and proper amount of detergent are sufficient to remove most stains.

RECOMMENDED POWDER DETERGENTS

ASKO washers use 50% to 75% less detergent than most other washers. This is because of their low water consumption and the fact that all the wash water is repeatedly circulated through the laundry, ensuring that all the detergent is fully utilized. We recommend that you use powder detergents made specifically for front-loading washers. These are sometimes called HE (High-Efficiency) detergents. Please visit our homepage www.askona.com to see the powder detergents we recommend for ASKO washers.

We recommend that you do not use any powder detergent that doesn't wash completely out of the detergent drawer.

DETERGENT AMOUNTS BASED ON WATER HARDNESS

The amount of detergent needed can vary due to differences in water hardness. To determine the water hardness in your area, contact your local water utility or area water softening company. The harder the water, the more detergent you may need. Refer to the chart below for the recommended detergent amounts based on water hardness. Remember, you should adjust the amount of detergent you use by small amounts until you find the correct amount.

Note that 12 grains and higher is extremely hard water and detergent alone may not be enough. You may need to use a water softener to maximize the performance of your washer. Also, in areas with hard water (9+) you may need to wash at lower temperatures to prevent hard water deposits from forming in the tank and wash system.

AMOUNT OF DETERGENT TO USE

The amount of detergent needed varies among the different brands, but for most detergents, you need only one or two tablespoons. Using too much detergent can result in detergent residue being left in your clothes, which can cause them to appear gray or dingy. You should start with a small amount of detergent and increase it only if the cleaning results are unsatisfactory.

Additionally, you should never put detergent in the prewash compartment unless you are using a wash program that has a prewash cycle. This could cause excess foaming, which could damage the machine.

The amount of detergent needed can also depend on the hardness of the water in your area. See the "Detergent Amounts Based on Water Hardness" section on the next page for more details.





USING YOUR WASHING MACHINE

Recommended detergent amounts based on water hardness

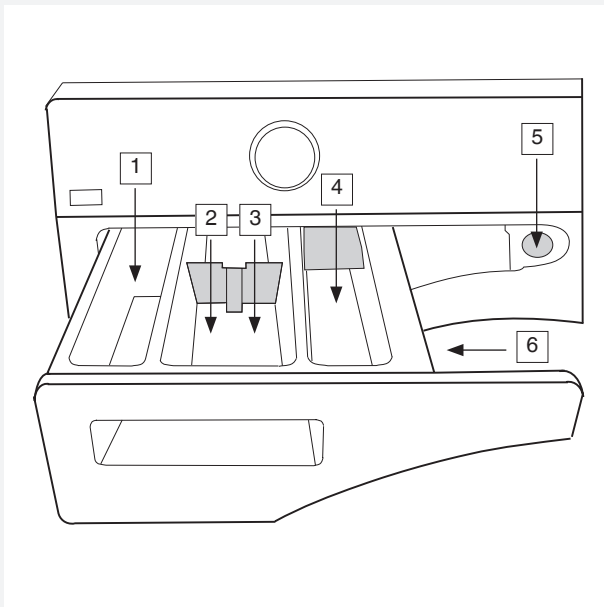
Detergent amounts		
Water hardness	Pre Wash	Main Wash
Soft (0-3 grains per gal.)	1 teaspoon	1 to 1-1/2 tablespoons
Medium (4-8 grains per gal.)	1 teaspoon	1 to 2 tablespoons
Hard (9+ grains per gal.)	1 teaspoon	2 to 3 tablespoons

ADD DETERGENT AND FABRIC SOFTENER



1. Pre-wash 
2. Main wash with liquid detergent.
Use the separator. 
3. Main wash with powder detergent.
Do not use the separator. 
4. Fabric softener 
5. Release button
6. Child safety catch

The quantity of detergent needed depends, among other things, on water hardness. See the detergent pack for details. Phone your local water company to check the water hardness in your area.

The detergent packaging will have recommendations for how much detergent you should use. The machine holds 24 lb (11 kg) of laundry. If you only have a small amount of laundry in the machine, you can reduce the amount of detergent used.

Powder detergent

Pour the powder into the main wash compartment, and pre-wash compartment as well if desired. Do not use the separator in the main detergent compartment.

Liquid detergent

Use the separator in the main detergent compartment. Pour the liquid detergent into the front section of the detergent compartment. (For thick detergent, we always recommend using a wash ball.)

Wash ball or net

If you use a wash ball or net, place it directly in the drum and select a program without pre-wash.

NOTE!

Detergent overdosing does not give better washing results; it merely causes a greater impact on the environment.

Try using less detergent, and increase only if you are not satisfied with the results.

Fabric softener

Pour the fabric softener into the compartment with the  symbol. Follow the recommendations on the fabric softener packaging.

NOTE!

Do not fill above the compartment's maximum fill level. Otherwise fabric softener will be dispensed too early, which impairs the washing effect.

USING YOUR WASHING MACHINE

PROGRAM SELECTION

You select a program by turning the program selector. The selected program is shown on the display. Now use the option buttons to select any options. See the Selecting Options chapter.



1. Auto

This program automatically adjusts the length of the main wash and the number of rinses to the amount and type of laundry loaded in the machine.

2. Time Choice

This program adjusts itself to the specified time frame or finish time. When using this program, it is however important to select a temperature and time suited to how soiled the laundry is. The spin speed can be selected freely.

Specify the desired program time by pressing + or - on the Time button. The symbol for the program lights beside the selected time. You can choose a program time between 30 minutes and 3 hours. If you choose a 30-minute program time the maximum wash temperature will be 86 °F (30 °C)

3. Sani

Program for heavily soiled laundry, with dirt that needs to be fully dissolved before the main wash. A pre-wash is used to do this.

The machine adapts the program time and water consumption to the load size.

4. White

HeavyWhite program description

Program for normally to heavily soiled laundry, whites and colors. You can select the temperature freely, so follow the washing instructions for each garment. 140 °F (60 °C) is a good temperature for heavily soiled cotton garments, as well as for garments worn next to the skin. Select 104 °F (40 °C) if the laundry is less soiled. The spin speed can be selected freely. The machine adapts the program time and water consumption to the load size.

5. Color

A standard program for lightly to moderately soiled laundry. The temperature can be selected freely, so follow the washing instructions for each garment. Garments worn next to the skin ought to be washed at 140 °F (60 °C). Very lightly soiled laundry often comes clean already at 104 °F (40 °C). The spin speed can be selected freely.

6. Quick

Program for normally soiled cotton and/or linen clothes for daily use. You can select "Cold" (incoming water temperature), 104 °F (40 °C), or 140 °F (60 °C). The lower the selected temperature, the shorter the program time. Garments worn next to the skin should be washed at 140 °F (60 °C).

7. Everyday Wear

Program for synthetics, mixed fiber, and easy care cotton. The program has a High Water Level and as such is also suitable for cushions, quilted jackets, and similar items. Read the washing instructions carefully and remember, for example, that fabric softener must not be used with the membranes found in some outer garments. A washing temperature up to 140 °F (60 °C) and a spin speed up to 1200 rpm can be selected.

8. PermaPress

Program for delicate garments made of synthetic fibers, mixed fibers, rayon, and easy care cotton. The maximum temperature is 140 °F (60 °C), but follow the washing instructions for each garment. Many synthetics will come clean at 104 °F (40 °C). Garments worn next to the skin ought to be washed at 140 °F (60 °C). The maximum spin speed is 600 rpm.

9. Wool/hand Wash

A gentle laundry program for wool, silk, and garments that should be washed by hand. The highest temperature is 86 °F (30 °C).

The program has a short spin. The maximum spin speed is 600 rpm.

10. Rinse

This program performs one cold rinse cycle + spin. Suitable for laundry that just needs to be dampened and for cleaning cloths and mops.

11. Spin

Used to simply spin the wash.

12. Drain

Used when you only want to drain the water from the machine.

USING YOUR WASHING MACHINE



SELECTING OPTIONS

You can select options to adjust the wash program to suit your own specific requirements. The available options depend on the selected program. If the option is available for the selected program, the symbols light up when you press the button.

The machine will remember the options you select for each program (applies to Super Rinse, High Water Level, and Super Wash). You can still change the selected options the next time you select the same program.



Temperature

- Select the temperature by pressing the -/+ buttons until the desired temperature is displayed.
- You can select temperatures between cold (-) and 194 °F (90 °C). By selecting cold, the wash temperature will be the same as the temperature of the water entering the machine. For Wool/hand Wash, it is not possible to select a temperature above 104 °F (40 °C). When selecting Time Choice, PermaPress, or Everyday Wear, the maximum temperature is 140 °F (60 °C).



Spin

- Select the spin speed by pressing the -/+ buttons until the desired spin speed is displayed.
- You can select speeds between 400 and 1400 rpm, @ (no spin), or No D (no drain). The maximum spin speed varies according to the selected program. The speed is shown on the display.
- @, means that the program does not include a spin cycle and ends by draining.
- No D, No drain means that the program does not include a spin cycle and ends with the water from the final rinse still in the machine. The washing will remain covered by the water from the final rinse, stopping it from getting wrinkled. If you have selected "No drain", once the program has ended you must select the Spin or Drain program to drain the water from the machine before you open the washer door.



Delayed Start

When you select Delayed Start, the machine will start 1-24 hours after you press the Start button. This option cannot be used with Time Choice.

- Select Delayed Start by pressing the + button under the time display. Delayed Start is shown for three seconds.
- By pressing the -/+ buttons under the time display you can delay the start in whole hours up to a maximum of 24 hours. The symbol for Delayed Start lights beside the number of hours.
- Press Start and the machine will count down 1 hour at a time, starting after the selected delay.

If you change your mind and want to cancel Delayed Start, press and hold the Stop button for three seconds.

NOTE!

Remember to press the Start button to start the program.

NOTE!

Make sure the detergent compartment is completely dry before you add detergent, otherwise there is a risk that the detergent will clump before the machine starts.



Super Rinse

Use the Super Rinse option if you want to increase the number of rinses. The maximum number of rinses is seven and varies depending on the selected program. Recommended for persons with extremely sensitive skin and/or in areas with very soft water.

- Select Super Rinse by pressing the button under the symbol.
- The symbol above the button lights when this option is activated.



High Water Level

Use High Water Level if a garment's laundry label shows this symbol. High Water Level means additional water is used during the main wash and rinse cycles.

- Select High Water Level by pressing the button under the symbol.

USING YOUR WASHING MACHINE

- The symbol above the button lights when this option is activated.

NOTE!

The machine takes in the additional water for the High Water Level about 15 minutes after the main wash has started.

Anti Wrinkle

Anti Wrinkle means the drum will rotate for three seconds each minute for two hours once the wash program has finished. This function prevents the clothes from lying in the same position and getting wrinkled.

- Select Anti Wrinkle by pressing the button under the symbol.
- The symbol above the button lights when this option is activated.

Super Wash

Super Wash can be selected to better dissolve difficult stains and heavy soiling on clothing. This option adds a cold pre-wash and the wash time in cold water is extended by approximately six minutes. The main wash time is also extended.

- Select Super Wash by pressing the button under the symbol.
- The symbol above the button lights when this option is activated.

Presoak

Super Wash can be selected to better dissolve difficult stains and heavy soiling on clothing. This option adds a cold pre-wash and the wash time in cold water is extended by approximately six minutes. The main wash time is also extended.

If the laundry is stained, such as with blood, we recommend Presoak. The laundry will soak in cold water for two hours before the wash program starts.

- Select Presoak by pressing the button under the symbol.
- The symbol above the button lights when this option is activated.

DURING THE PROGRAMME

Time remaining

The time remaining is shown in hours and minutes. The time remaining is updated three times during the program. The first update takes place after about 15 minutes. Once a program is selected, the estimated program time is displayed. This may differ from time to time depending on the temperature of the water entering the machine and the size of the load. If the program time is longer than

the previous wash with the same program, "0:01" will be displayed until the program finishes. This is normal! The next time you use the program under similar conditions, the estimated program time will be more accurate.

Stopping or changing a program

You can stop a program by pressing the Stop button for three seconds. "Stop" appears on the display. To restart the machine, select a new program, add any extra detergent needed, and press the Start button.

NOTE!

Do not open the detergent compartment while the machine is running.

SETTINGS

HOW TO CHOOSE THE SETTINGS

- 1 Turn off the machine using the main power switch.
- 2 Press and hold the Stop button and then press the main power switch. Then press the Stop button 5 times within 10 seconds.
- 3 Select the setting you want to change by turning the program selector.
- 4 Press Stop once.

MAKING A SELECTION

Turn the program selector until the desired selection is shown on the display

SAVING A SELECTION

- 1 Press Stop to save the selection and return to the settings menu.
- 2 Press Start to enter the program menu.

Options:

Press Start to save the selection and return directly to the program menu, if you do not want to make anymore settings.

YOU CAN CHANGE THE FOLLOWING SETTINGS

Child-safe Start

You can activate the Child-safe Start option to prevent children from starting the machine. Select "Child-safe On" or "Child-safe Off".

Deactivate the Child-safe Start option temporarily for three minutes by simultaneously pressing the buttons as illustrated:



Language

Choose from: US English, AU English, Svenska, Dansk, Norsk, Suomi, Français, Deutsch, Italiano, Espanol, Русский, Ned erlands, EU English.

Temperature

Choose between: °C and °F.

Extra rinses

Upon delivery, your washing machine is set to use three rinses in White and Color.

Choose "Rinses On" for five rinses or "Rinses Off" for three rinses.

CARE AND CLEANING

CLEANING THE TRAP AND THE DRAINAGE PUMP

The washing machine has a trap where small items such as coins, buttons, and hairpins can collect. To clean the trap and the drain pump, do as follows:

- 1 Make sure the machine is empty of water and switched off at the main power switch.

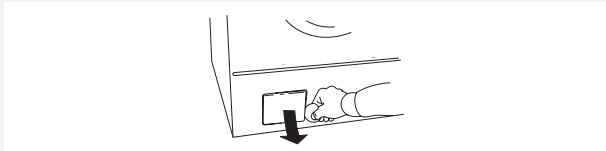

- 2 Open the door.

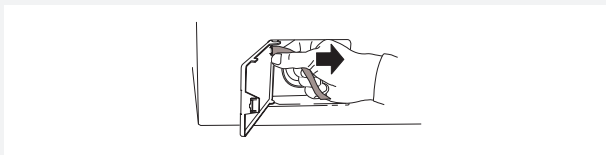

- 3 Unhook the drain hose from the connector inside the door and drain the water into a suitable container, such as a shallow bowl.

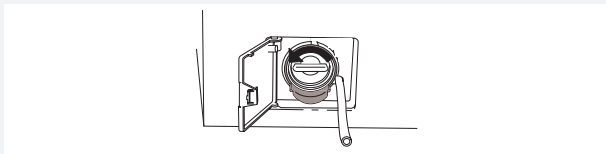

- 4 Turn the cover counter-clockwise to open the pump. Remove the cover.

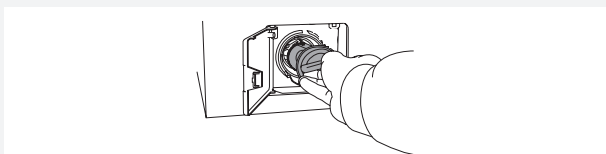

- 5 Remove any items and debris from the pump housing and cover. Also check that the pump impellers at the back rotate.

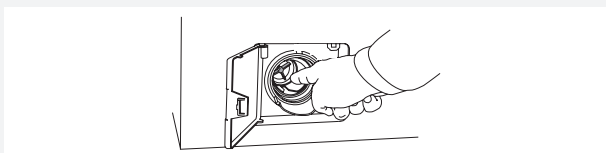

- 6 Screw on the cover, replace the drainage hose on the hatch pin, and close the hatch.

CLEANING THE DETERGENT COMPARTMENT

Pull out the detergent compartment using the release button.

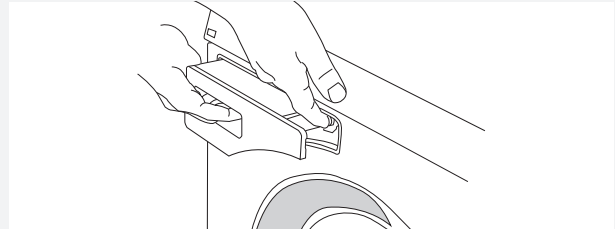

Rinse the compartment and scrub it clean. The cover in the fabric softener compartment can be removed.

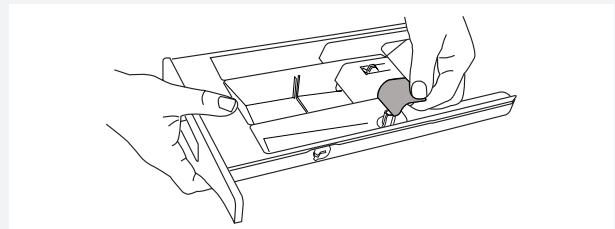

NOTE!

Do not run the detergent compartment through a dishwasher!

CLEANING THE OUTSIDE OF THE MACHINE

Clean the outside of the machine and the program panel with a mild cleaner. Do not use any solvents, as these can damage the machine.

NOTE!

Do not hose down the machine with water!

CLEANING THE INSIDE OF THE MACHINE TO AVOID UNPLEASANT SMELLS

Run a programme at 90 °C or 95 °C (depending on the model) with a small amount of detergent once a month to avoid problems with odours. It is not necessary to put any washing in the machine.

RINSE HOLES UNDER THE AGITATOR

If you suspect that objects such as nails or paper clips may have fallen into the wash drum, you should check the space under the paddles. Such objects can rust and leave marks on clothing. Nails and other sharp objects can make holes in fabrics.

CARE AND CLEANING

Do as follows:

- 1 Insert a screwdriver or the like into the hole on the agitator as illustrated and carefully pry to the left.



- 2 Use your other hand to grasp the paddle and pull it toward you.

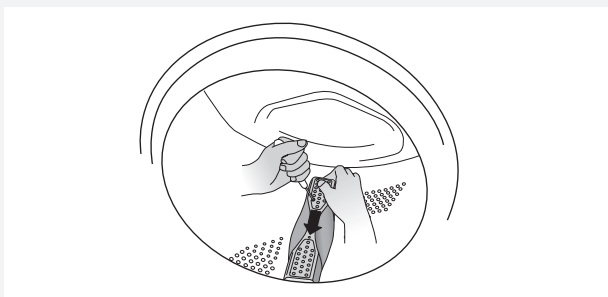

- 3 Lift the paddle.
- 4 Remove any objects.
- 5 Place the paddle in the mounting hole with the F-mark toward you. Ensure that all the paddle fasteners are in their holes in the drum. Push it in until it catches.

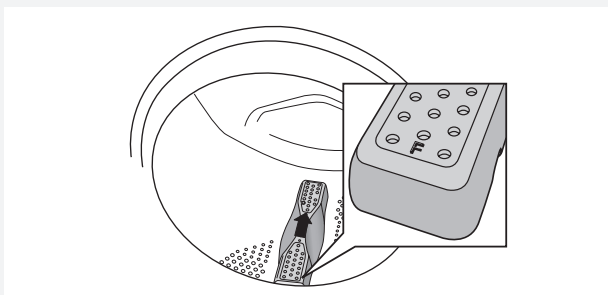

IF YOU HAVE HARD WATER

If you live in an area with hard water (high limescale content), a grayish-white coating may form on the washer drum. To remove this, empty a sachet of citric acid, approx. 20 gram (1 oz), into the washer drum and run any 194 °F (90 °C) program. Repeat if necessary.

TROUBLESHOOTING

THE WASHER DOOR WILL NOT OPEN

- Check that the main power switch is on.
- Has the power supply been cut off? Check the house fuses (circuit breakers).

OPENING THE DOOR IN AN EMERGENCY:

⚠ WARNING

The door may only be opened manually if the electric power is cut and the machine has been drained of water.

- 1 Run the Drain program to empty the water from the machine. If this does not work, the machine must be drained manually. See “Cleaning the trap and the drain pump” in the “Care and cleaning” chapter.
- 2 Ensure that the main power switch is turned off and that the plug has been removed from the wall socket.
- 3 Take the emergency door opening tool and place it in the gap on the right side of the washer door lock. The tool is attached to the rear of the detergent compartment. Remove the detergent compartment from the machine and remove the emergency door opening tool.
- 4 Push the tool downward to open the washer door.

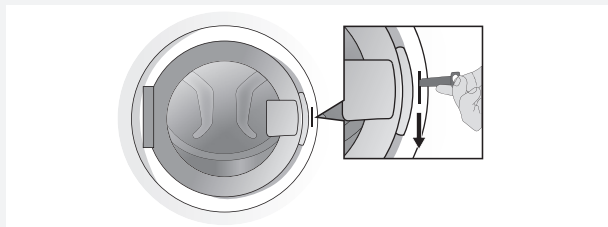

THE MACHINE WILL NOT START

- Is the washer door properly closed? Push it firmly. Then press the Start button.
- Is there power? Check the fuses and residual current devices (circuit breakers) in the building.
- Check that you have not selected Delayed Start. To cancel Delayed Start, press the Stop button for three seconds.

AFTER POWER FAILURE

Press the main power switch to resume the current program.

WET WASHING STILL IN THE MACHINE

Under certain circumstances, a small load can cause imbalance Unbalance (see “Unbalance”). Rearrange the load and start the spin program, or load more laundry and restart the washing program.

ERROR MESSAGES

If an error occurs during the program, a message is shown on the display. To exit the message after taking action, turn the machine off and then back on.

The error messages that may be shown in the display are:

Close the Door

Close the washer door and press Start to start the program.

Over flow fault

- 1 Shut off the water tap.
- 2 See “Drainage error”.

Water outlet fault

Check:

- that no objects are stuck in the drainage hose outlet.
- that the drain pump is not blocked by foreign objects. Clean the pump. See the “Care and cleaning” chapter.
- that there are no kinks in the drainage hose.

After the above, run Drain to empty the machine. If this does not resolve the problem, call the Customer Care Center.

Water Inlet Fault

Check:

- that the tap on the water pipe is open.
- that the filter in the machine’s water intake is not blocked.

Action:

- 1 Turn off the water supply valve and unscrew the hose.
- 2 Clean the filter in the intake valve on the machine.
- 3 Screw the hose back on and turn on the valve.
- 4 Run the program again to check whether the error has been fixed.
- 5 If this does not resolve the problem, call the Customer Care Center.

Wash Motor Fault

Contact the Customer Care Center at the number listed at the bottom of this page!

Unbalance

The machine stops the spin cycle if there is too much imbalance. The washing machine restarts the spin cycle and hopefully the laundry is better distributed in the drum. This procedure can be repeated up to 10 times. If the machine still fails to find a good balance, the program jumps to the next step.

The error message requires no action.



TECHNICAL INFORMATION

TECHNICAL DATA

Height:	33 1/2" (850 mm)
Width:	23 1/2" (597 mm)
Depth:	27 7/8" (716 mm)
Weight:	181 lb (82 kg)
Cylinder volume:	21,1 gal (80 l)
Rated power:	See serial number tag and rating plate.
Heater output:	See serial number tag and rating plate.
Water pressure:	14-145 psi
Wash drum and liquid compartment material:	Stainless steel
Outer casing material:	Powder-coated and hot-galvanized sheet steel or stainless steel.
Water connection:	59" (1.5 m) pex pipe
Drain:	67" (1.7 m) polypropylene hose

INSTALLATION

Read these instructions carefully and completely before you install the machine. The installation should be carried out by a qualified person who is familiar with all local codes and ordinances for electrical and plumbing connections.

Cosmetic damage must be reported to your dealer within five days from the date of purchase. After unpacking the washer, thoroughly check the unit for cosmetic damage.

LEVELING THE MACHINE

It is important that the machine is level to prevent excessive vibrations during spin cycles. Each foot of the washer is adjustable, so you can level the washer on any surface. Once it is level, securely tighten the lock nuts on the feet to prevent excessive vibration during spin cycles.

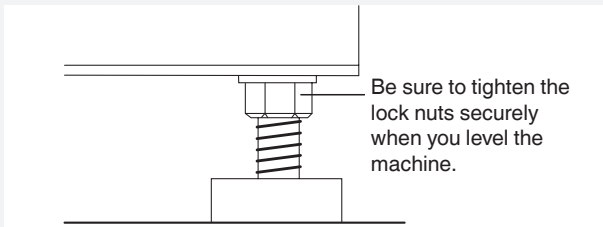

WATER SUPPLY CONNECTION

Since ASKO washers have a built-in heating element, you only need a cold water inlet. The connection should be made by someone who is sufficiently skilled. Use the hose supplied with the washer. (The inlet hose is marked for correct connection.) The water pressure must be in the range 15–146 PSI. A valve should be fitted on the water supply pipe. If a new supply pipe has been installed for the washer, it should be flushed thoroughly to remove any foreign particles that might clog the filter in the fill valve.

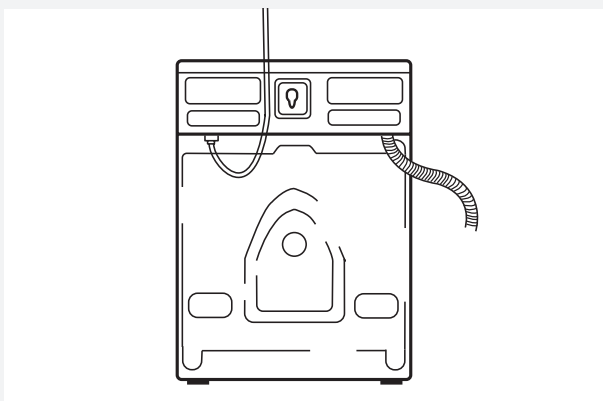

NOTE!

If the unit is installed on a second storey, follow local building codes. We recommend installing a drip pan.

DRAIN OUTLET CONNECTION

The machine is supplied with the outlet hose already attached. The hose should be extended over a suitable sink edge or drain pipe at a height of 24" to 36" (610 mm to 914 mm) above the bottom of the unit. (The lower height is preferable.) Make sure the hose is not kinked.

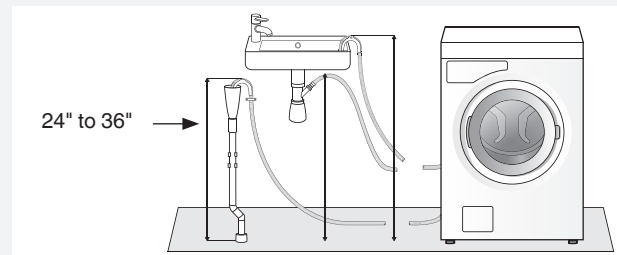

NOTE!

If the hose is extended, the internal diameter of the coupling must not be less than 1/2".

⚠ WARNING

Do not extend the drain hose higher than 36" (914 mm) from the bottom of the unit.

ELECTRICAL INSTALLATION

The machine is delivered ready-fitted with a plug and is intended for connection to an ASKO Dryer, which is equipped with a matching receptacle. The plug supplied with the washer can only be used with an ASKO Dryer. If the washer is used separately or with another dryer, it must be on a separate 208-240 V single-phase circuit.

If the machine is to be used in a wet area, the supply must be protected by a residual current device.

As supplied: 208-240 V, 60 Hz, 2000 heating element, 15 A timed delayed fuse is required.

⚠ WARNING

Connection to a permanently wired supply point must be made only by a qualified electrician

GROUNDING INSTRUCTIONS

This appliance must be grounded. In the event of malfunction or breakdown, grounding will reduce the risk of electric shock by providing a path of least resistance for electric current. This appliance is equipped with a cord having an equipment-grounding conductor and a grounding plug. The plug must be plugged into

an appropriate outlet that is properly installed and grounded in accordance with all local codes and ordinances.

INSTALLATION

FREESTANDING INSTALLATION

The washer can be placed next to the dryer. It is essential that the machine is leveled and the locknuts are tightened to prevent excessive vibration during spin cycles. Also be sure to leave a minimum of 1/2" of space between the washer and the dryer. The height adjustment for the washer is 33 1/2" to 34 1/2" (850 mm to 876 mm). Do not raise it higher than 34 1/2" (876 mm).

⚠ WARNING

Improper connection of the equipment-grounding conductor can result in a risk of electric shock. Check with a qualified electrician or serviceman if you are in doubt as to whether the appliance is properly grounded.

Do not modify the plug provided with the appliance. If it will not fit the outlet, have a proper outlet installed by a qualified electrician.

STACKED INSTALLATION

ASKO washers should never be stacked on a counter or a dryer. You can, however, stack an ASKO dryer on an ASKO washer. Refer to your Dryer Use and Care Guide for instructions on how to do this.

BUILT-IN INSTALLATION

ASKO washers can be installed beneath a cabinet or worktop with a height of 34" to 35" (863 to 889 mm) or in a closet. There must be a gap of about 1/2" (12 mm) all around the machine, including between the rear edge of the machine's top panel and the back wall. The opening width must be at least 24 1/2" (622 mm). Space must also be available for the fill and drain hoses. See the illustration below for measurements and positions. If the washer is installed in a closet the door must be left open while the washer is running.

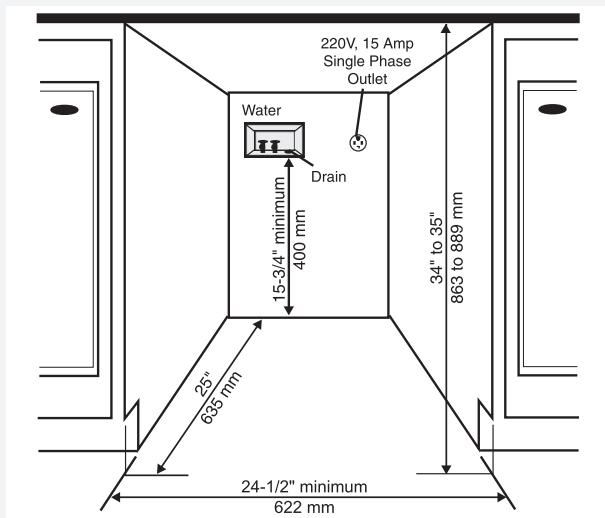

If the drain outlet is higher than 24" (610 mm), the connections will need to be recessed.

LIMITED WARRANTY – RESIDENTIAL APPLIANCES

ASKO Distribution North America, LLC. (hereinafter "ASKO") warrants the original purchaser (the "ASKO Customer") of the ASKO product (the "ASKO Product"), who purchased the appliance from a distributor, dealer, manufactures representative or other seller who has been authorized by ASKO ("Authorized ASKO Dealer"), that this ASKO Product is free of defects in material and workmanship, subject to the terms and conditions set forth herein. The limited warranty covers parts and labor, except as set forth in this Limited Warranty. Service must be provided by an ASKO designated service company. YOUR SOLE AND EXCLUSIVE REMEDY UNDER THIS LIMITED WARRANTY SHALL BE PRODUCT REPAIR AS PROVIDED HEREIN. The limited warranty is valid only in the United States or Canada and applies only when the appliance is used in the country in which it was purchased. Proof of original purchase date is required to obtain service under this limited warranty.

Residential ASKO Products Used Exclusively for Household/Personal Purposes:

Two (2) Years limited Warranty – Any warranty service claims for residential ASKO Products must be filed with ASKO within two (2) years from date of purchase.

Residential ASKO Products Not Used Exclusively for House Hold Purposes, used Commercially or Use in marine, Mobile or Aeronautical Applications:

One (1) Year limited Warranty – Any warranty service claims for ASKO Products not used exclusively for household and personal use, used commercially or used in marine, mobile, or aeronautical application must be filed with ASKO within One (1) year from date of purchase.

ITEMS EXCLUDED FROM WARRANTY

This limited warranty does not cover:

- 1 Replacement parts or repair labor if this appliance is used in a manner that is inconsistent to published user or operator instructions and or/or installation instructions.
- 2 Service calls to correct the installation of your appliance, to instruct you on how to use your appliance, to replace or repair house fuses, or to correct house wiring or plumbing.
- 3 Consumable parts are excluded from warranty coverage.
- 4 Damage resulting from accident, alteration, misuse, abuse, fire, flood, acts of God, improper installation, installation not in accordance with electrical or plumbing codes, or use of products not approved by ASKO.



INSTALLATION

- 5 Cosmetic damage, including scratches, dents, chips or other damage to the finish of your appliance, unless such damage results from defects in material or workmanship and is reported to ASKO within 5 days from date of purchase.
- 6 Pickup and delivery. This appliance is intended to be repaired in your home.
- 7 Repairs to parts or systems resulting from unauthorized modifications made to the appliance.
- 8 Expenses for travel and transportation for product service if your appliance is located in a remote area where service by an authorized ASKO servicer is not available.
- 9 The removal and reinstallation of your appliance if it is installed in an inaccessible location or is not installed in accordance with ASKO's published installation instructions.
- 10 Replacement parts or repair labor on appliances with original model/serial numbers that have been removed, altered or cannot be easily determined.

DISCLAIMER OF IMPLIED WARRANTIES

YOUR SOLE AND EXCLUSIVE REMEDY UNDER THIS LIMITED WARRANTY SHALL BE PRODUCT REPAIR AS PROVIDED HEREIN. ASKO SHALL NOT BE LIABLE FOR INCIDENTAL OR CONSEQUENTIAL DAMAGES. Some states and provinces do not allow the exclusion or limitation of incidental or consequential damages, so these limitations and exclusion may not apply to you. This warranty gives you specific legal rights, and you also may have other rights that vary from state to state or province to province.

If you think you need repair service, first see the "Trouble Shooting" section of the Use & Care Guide. If you are unable to resolve after checking "Trouble Shooting" additional help can be found by calling ASKO Customer Care at 1-800-898-1879

Should you need further assistance, you can write to ASKO Appliances with any questions or concerns at the address below:

ASKO Distribution North America, LLC.

Customer Care Center

PO Box 44848

MADISON WI 53744

PROGRAM CHART

Program	Pre Wash	Temp. °F	Number of rinses	Spin Speed rpm	Max. load (lb)	Consumption values		
						Water consumption (approx. gallon)	Energy consumption (approx. kWh)	Program time (approx. hrs and min.)
1. Time Choice								
2. Sani	X	203	5	1400	24	30,9	2.98	2:56
	X	140	5	1400	24	28,0	1.51	2:50
3. White		140	3	1400	24	23,5	1.51	2:31
		104	3	1400	24	23,5	0.92	2:12
4. Color		140	3	1400	24	21,4	1.61	1:49
5. Quick			2	1400	12	9,5	0.17	0:55
6. Everyday Wear		104	2	1200	12	21,1	0.80	1:45
7. PermaPress		104	3	600	8	11,4	0.54	1:24
8. Wool/hand Wash		86	3	600	8	24,8	0.67	0:55
9. Rinse			1	1400	12	4,8	0.10	0:21
10. Spin				1400	12	0,0	0.08	0:16
11. Drain								0:01

QUICK GUIDE

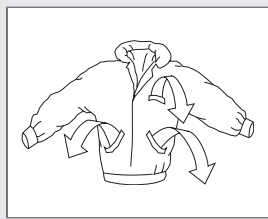

1.

SORT THE LAUNDRY, OPEN THE WASHER DOOR, AND LOAD THE LAUNDRY

Close zippers.

Look at the item's laundry label.

Sort the laundry according to how soiled it is, color, and material.

NB: Place underwired bras in a laundry net.

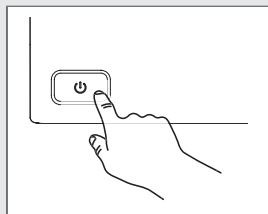

2.

TURN ON THE MAIN POWER SWITCH

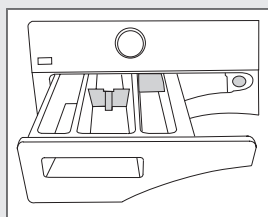

3.

ADD DETERGENT AND FABRIC SOFTENER, AS REQUIRED

The detergent packaging will have recommendations for how much detergent you should use. With only a small amount of laundry in the machine, you can reduce the amount of detergent used.

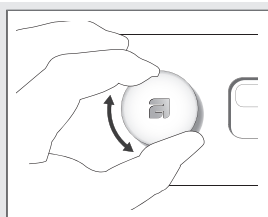

4.

SELECT A PROGRAM AND ANY OPTIONS

You select a program by turning the program selector. The selected program is shown on the display.

The available options depend on the selected program. If the option is available for the selected program, the symbols light up when you press the button.

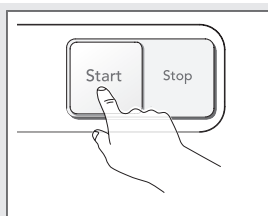

5.

CLOSE THE WASHER DOOR AND PRESS THE START BUTTON

The time remaining is shown in hours and minutes.

We reserve the right to make changes.

ASKO

Swedish quality since 1950

www.askona.com

CE WM80.2
W8844XL W US/CA



461760



en (01-14)