

INSTRUCTION MANUAL
AUTOMATIC BUILT-IN COFFEE MACHINE

EN

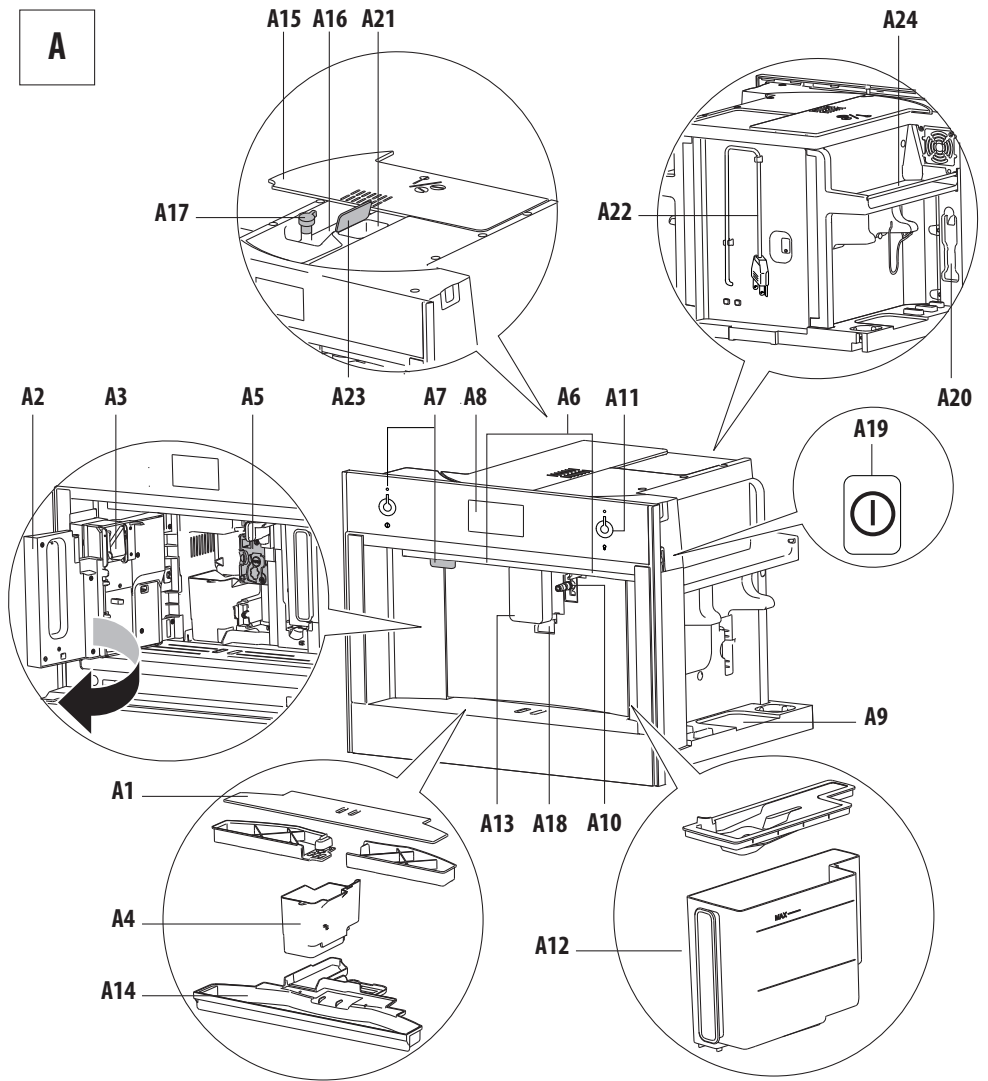

A



B

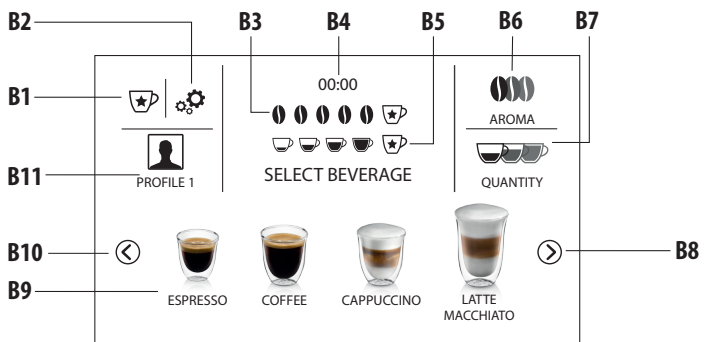

C

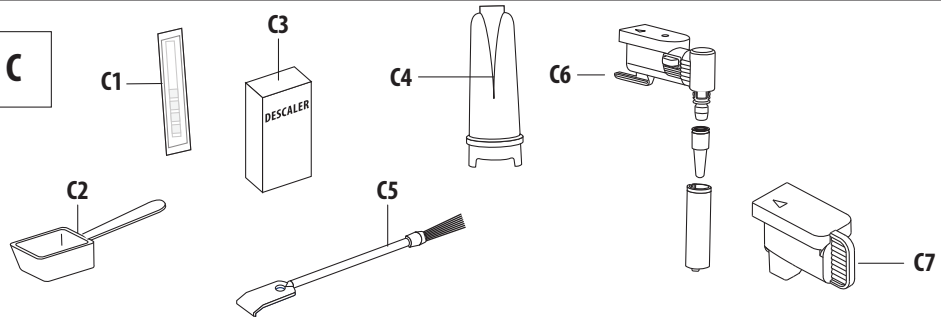

D

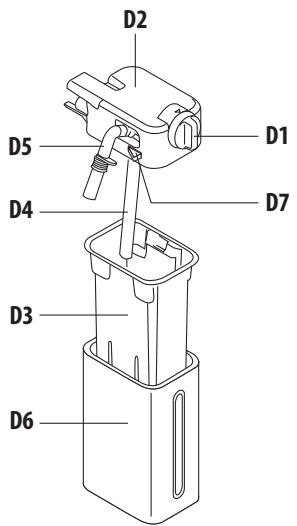

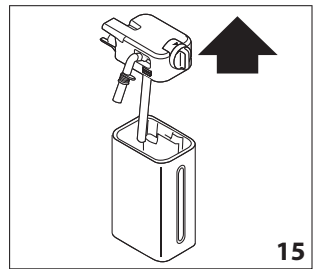
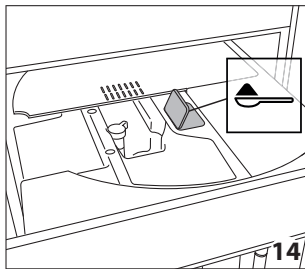
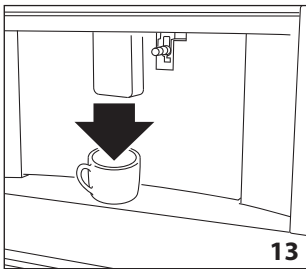
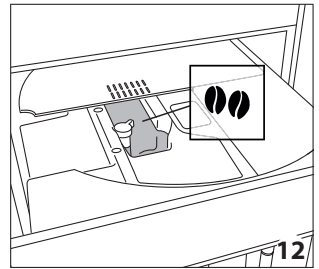
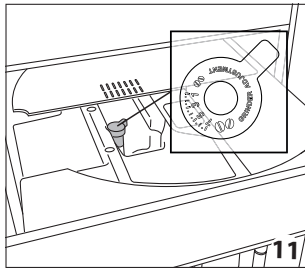
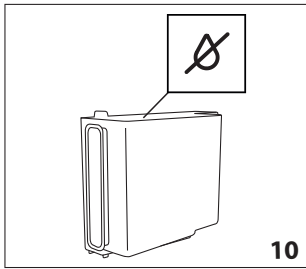
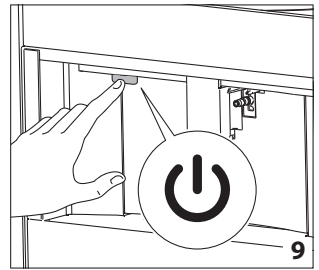
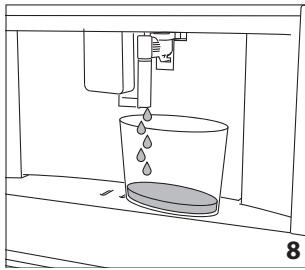
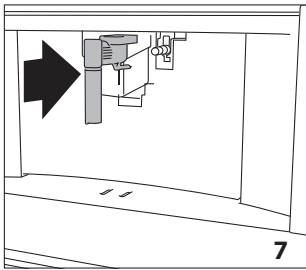
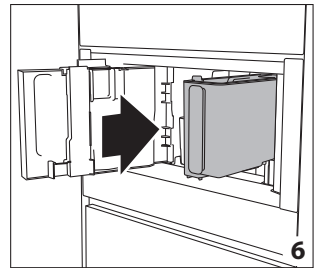
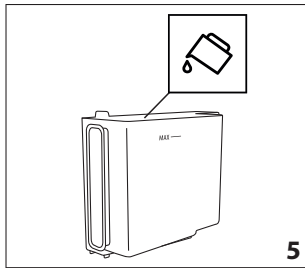
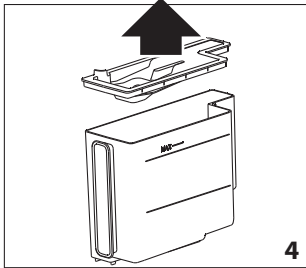
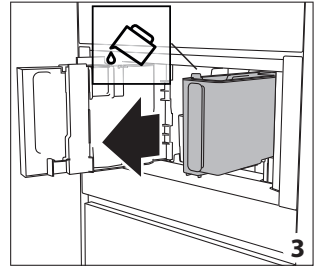
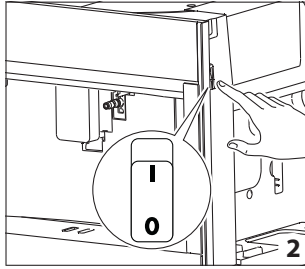
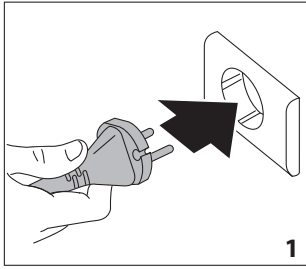

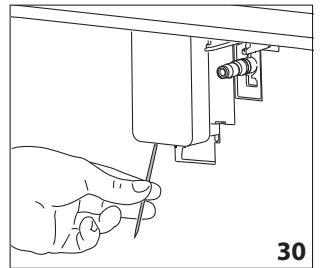
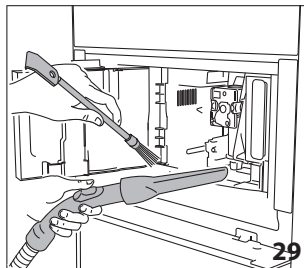
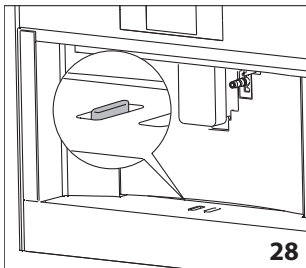
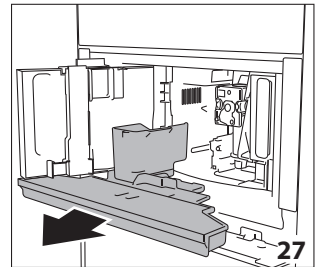
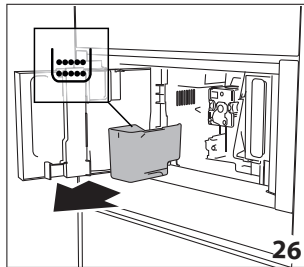
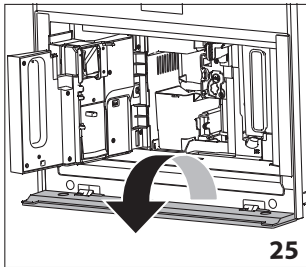
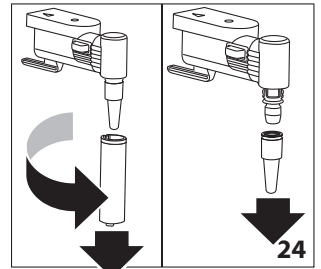
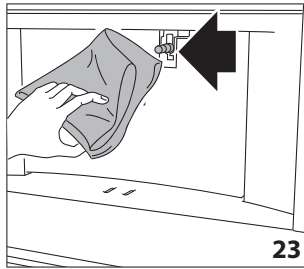
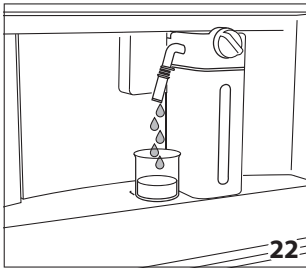
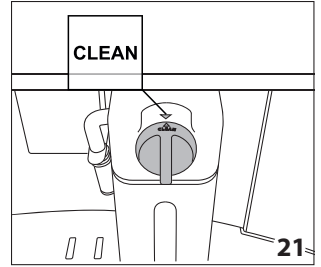
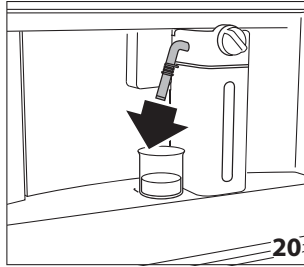
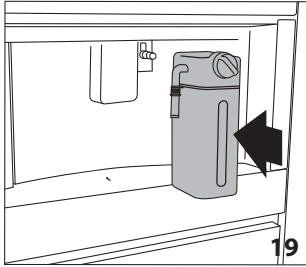
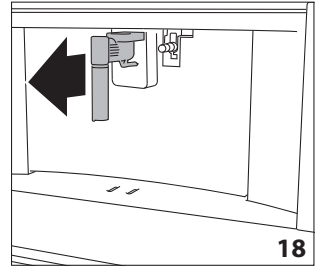
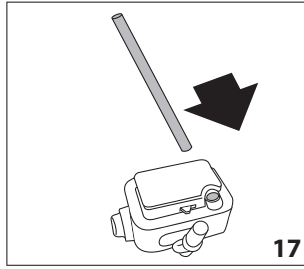
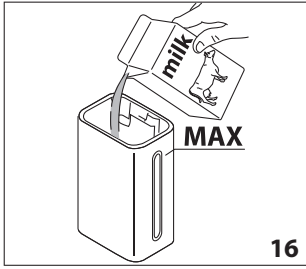

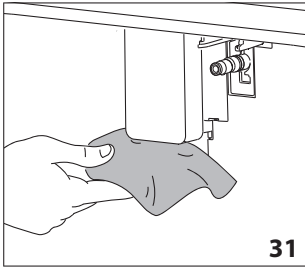

31

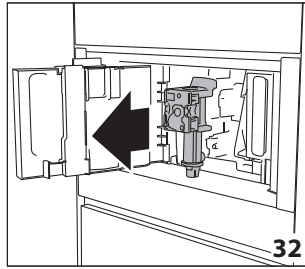

32

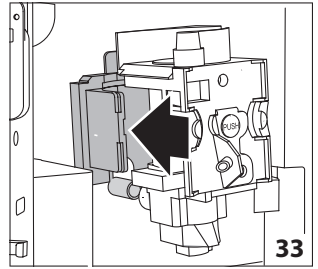

33

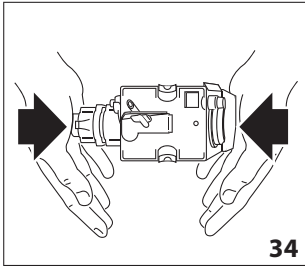

34

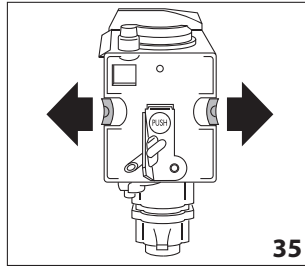

35

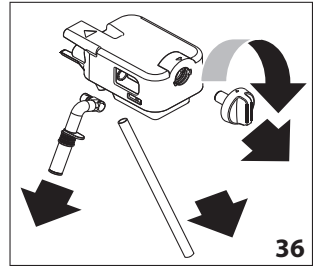

36

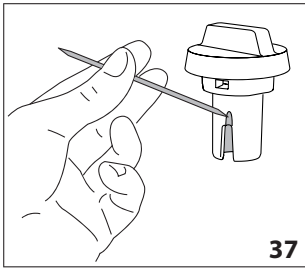

37

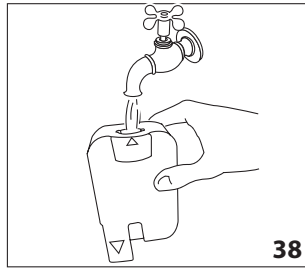

38

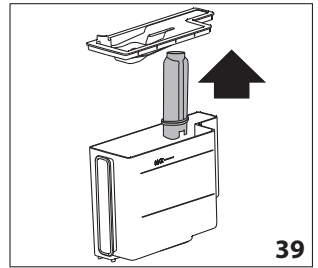

39

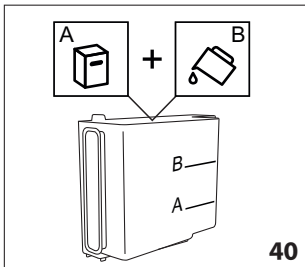

40

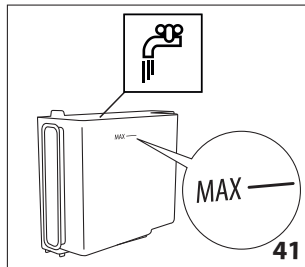

41

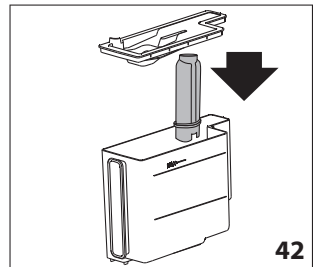

42

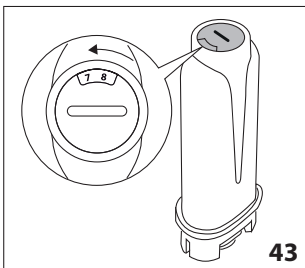

43

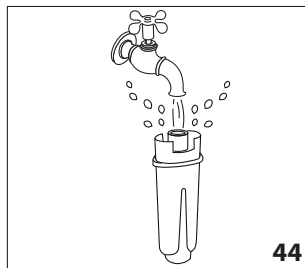

44

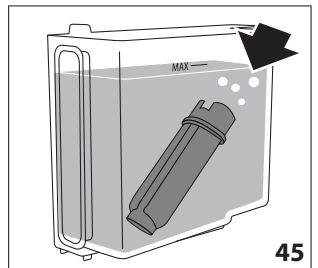

45

CONTENTS

INTRODUCTION	8	MAKING MILK-BASED HOT DRINKS	15
Symbols used in these instructions	8	Filling and attaching the milk container	16
Letters in brackets.....	8	Adjusting the amount of froth	16
Troubleshooting and repairs	8	Making milk based hot drinks automatically	16
Important safeguards	8	Cleaning the milk container after use	16
DESCRIPTION OF THE APPLIANCE	10	DELIVERING HOT WATER	17
Description of the appliance	10	STEAM DELIVERY	17
Description of homepage.....	10	Tips for using steam to froth the milk.....	17
Description of the accessories	10	Cleaning the hot water/steam spout after use	17
Description of milk container	10	CUSTOMISING BEVERAGES	17
PRELIMINARY OPERATIONS	10	MEMORISING YOUR PERSONAL PROFILE	18
Checking the appliance.....	10	CLEANING	18
SETTING UP THE APPLIANCE	10	Cleaning the machine	18
TURNING THE APPLIANCE ON	11	Cleaning the appliance internal circuit.....	18
TURNING THE APPLIANCE OFF	11	Cleaning the coffee grounds container.....	18
MENU SETTINGS	11	Cleaning the drip tray	19
Rinsing.....	11	Cleaning the inside of the coffee machine	19
De-scaling.....	12	Cleaning the water tank.....	19
Water filter.....	12	Cleaning the coffee spouts.....	19
Beverage settings	12	Cleaning the pre-ground coffee funnel	19
Set time	12	Cleaning the infuser.....	19
Auto -start	12	Cleaning the milk container	19
Auto-off (standby).....	12	Cleaning the hot water/steam connection nozzle	20
Cup warmer	13	DESCALING	20
Energy saving.....	13	PROGRAMMING WATER HARDNESS	21
Coffee temperature	13	Measuring water hardness.....	21
Water hardness	13	Setting water hardness	21
Selecting the language	13	WATER SOFTENER FILTER	21
Sound notification	13	Installing the filter	21
Light	13	Replacing the filter	22
Demo mode	13	Removing the filter	22
Default values.....	13	TECHNICAL DATA	22
Statistics	14	DISPLAYED MESSAGES	23
MAKING COFFEE	14	TROUBLESHOOTING	28
Selecting the coffee aroma	14		
Selecting the coffee quantity	14		
Making coffee using coffee beans	14		
Making coffee using pre-ground coffee	15		
Adjusting the coffee mill.....	15		
Tips for a hotter coffee	15		

INTRODUCTION

Symbol used in these Instructions

Important warnings are identified by these symbols. Failure to observe the Instructions for Use could result in electric shock, serious injury, burns, fire or damage to the appliance



Danger!

Failure to observe the warning may result in life threatening injury by electric shock.



Important!

Failure to observe the warning could result in injury or damage to the appliance.



Danger of burns!

Failure to observe the warning could result in scalds or burns.



Please note:

This symbol identifies important advice or information for the user.

Letters in brackets

The letters in brackets refer to the key in the Description of the appliance.

Troubleshooting and repairs

In the event of problems, follow the information given in the sections "Displayed messages" and "Troubleshooting".

If this does not resolve the problem, you should consult customer services. For repairs, contact customer services only.

IMPORTANT SAFEGUARDS

When using electrical appliances, basic safety precautions should always be followed, including the following.

Read all instructions before installation or use of the coffee system.

Please read these instructions carefully to prevent accidents and machine damage.

This appliances is for household use only, to prepare espresso, cappuccino and coffee. Do not use appliance other than for its intended use. Any other use could be dangerous. The manufacturer cannot be held responsible for damage caused by improper use of the appliance.

Electrical safety

- Before connecting the appliance to the electrical supply make sure that the voltage and frequency listed on the

data plate correspond with the household electrical supply. If in doubt, consult a qualified technician.

- The appliance must be properly installed before operation to ensure that no electrical components are accessible. Ensure that power is not supplied to the appliance while installation work, repairs or maintenance is performed.
- Be certain your appliance is properly installed and grounded by a qualified technician. To guarantee the electrical safety of this appliance, continuity must exist between the appliance and effective grounding system. It is imperative that this basic safety requirement be met. If there is any doubt, have the electrical system of the house checked by a qualified electrician. The manufacturer cannot be held responsible for damages caused by the lack, or inadequacy, of an effective grounding system.
- Do not use an extension cord to connect the appliance to electricity. Extension cord doesn't guarantee the required safety of the appliance (danger of overheating).
- Before service or maintenance disconnect the power supply by either switching off the main switch and unplugging the unit.
- Install or locate this appliance only in accordance with the provided installation instructions.
- Installation work and repairs must be only performed by a trained technician in accordance with national and local safety regulations. Repairs and other work by unauthorized persons could be dangerous and may void the warranty.
- Only use original spare parts. Only then can the manufacturer guarantee the safety of this machine.
- Never open the outer casing of the appliance. Tampering with electrical connections or components and mechanical parts is dangerous and may cause machine damage.
- If the machine is installed in combination with other appliances, a protective base should be installed between the appliance and the unit.
- Do not install or use outdoors even if installed in the display cabinet.
- To protect against fire, electric shock and injury to persons do not submerge the cord or plugs in water or other liquids.
- To reduce the risk of injury, do not drape cord over the counter top or table top where it can be pulled on by

children or tripped over unintentionally.

- Do not let the cord hang over the edge of a table or counter, or touch hot surfaces.
- Do not operate any appliance with a damaged cord or plug, or after the appliance malfunctions or has been damaged in any manner.
- Return appliance to an authorized service facility for examination, repair or adjustment.
- To disconnect turn the machine off, switch off the main switch then remove the plug from the wall outlet.
- To reduce the risk of fire, do not place any heating or cooking appliance beneath the appliance.
- To reduce the risk of fire, do not mount unit over or near any portion of a heating or cooking appliance.
- To reduce the risk of electric shock, do not mount over a sink.
- To reduce the risk of fire, do not store anything directly on top of the appliance surface when the appliance is in operation.
- The use of accessory attachments not recommended by the appliance manufacturer may result in fire, electric shock or injury to persons.

Use

The coffee system must be maintained daily to prevent the growth of harmful bacteria and mold. Please read the Cleaning section of the booklet.



Important! Do not look directly or with an optical instrument into the lighting.



Danger of burns! Risk of burns when dispensing hot beverages, they are extremely hot.

- Persons which lack physical, sensory or mental abilities or experience with the machine should not use it without supervision or instruction by a responsible person.
- Close supervision is necessary when any appliance is used by or near children.
- Do not touch hot surfaces. Use handles or knobs.
- To avoid injuries allow the coffee system to cool before cleaning or putting on and taking off parts. Turn the machine off at the main switch when not in use and before cleaning.
- Only fill the water tank with cold, fresh tap water. Warm or hot water, or any other liquids may damage the machine.
- The water should be changed daily to prevent bacteria or mold growth.

- Do not use mineral water. Mineral water leads to heavy calcium buildup in the machine that can damage the unit.
- Do not fill anything but coffee beans into the beans container. Do not fill ground coffee in the beans container, it will damage the grinding unit.
- Sugar can damage the appliance! Caramelized or otherwise pre-treated coffee beans or other sugar containing beverages must not be put in the machine.
- Never place a cup with an alcohol-coffee mixture underneath the coffee dispenser. Plastic parts of the unit could catch fire!
- The hot water and steam dispensed could cause scalding. These functions must be used carefully. Never hold any parts of the body under the steam nozzle or the hot water dispenser. The machine must never be used to clean objects.
- Never use a steam cleaner to clean the appliance. Pressurized steam could damage electrical components and cause a short circuit.
- The appliances must be descaled regularly with the supplied descaling tablets. In areas with very hard water the machine may need to be descaled more often. The manufacturer cannot be held responsible for damages resulting from insufficient descaling.
- Only use the descaling tablets. Take care to use the correct mixture of water and descaler, otherwise it may cause damage.
- Never make coffee, hot water or steam when the appliance is extracted. Always make sure the appliance is inactive before extracting it. Failure to observe this precaution could lead to damage to the appliance! The only exception is adjusting the coffee mill which must be done with the machine out (see the section "Adjusting the coffee mill").
- Do not place on or near a hot gas or electric burner, or in a heated oven.
- The cleaning and user maintenance shall not be made by children without supervision.

SAVE THESE INSTRUCTIONS

THIS APPLIANCE IS FOR HOUSEHOLD USE ONLY



Important!

Do not allow children and animals to stop or linger near the appliance when it is pulled out of the cabinet.

Do not leave the machine pulled out of the cabinet when it is being used.

Do not leave the machine pulled out of the cabinet when it is not needed.

Install the machine according to the instructions in the handbook to guarantee there are no spills when it is pulled out from the cabinet.

The rail fixing panel must have a thickness suited to the fixing screws provided.

The panel material must be suited to the machine weight of approximately 55lb (25kg).





Please note: Empty the water tank if the appliance is not used for extended periods (holidays etc.).

Replace the water if the appliance is not used for more than two days. Fill with fresh drinking water.

DESCRIPTION OF THE APPLIANCE







Description of the appliance

(page 3 - A)

- A1. Cup holder tray
- A2. Service door
- A3. Coffee guide
- A4. Coffee grounds container
- A5. Infuser
- A6. Lighting to illuminate interior compartment
- A7. On/stand-by button /  knob (only on some models)
- A8. Control panel
- A9. Tray for objects
- A10. Hot water/steam connection nozzle
- A11.  Lighting knob to illuminate the interior compartment (only on some models)
- A12. Water tank
- A13. Coffee spouts (adjustable height)
- A14. Drip tray
- A15. Beans container lid
- A16. Beans container
- A17. Grinding adjustment dial
- A18. Lights to illuminate cup
- A19. Main ON/OFF switch
- A20. Measure holder
- A21. Ground coffee funnel
- A22. Power cord
- A23. Pre-ground door
- A24. Cup warming ledge

Description of homepage (page 3 - B)

- B1. : menu to customise beverages settings

- B2. : appliance settings menu
- B3. Selected aroma
- B4. Clock
- B5. Selected quantity
- B6. : aroma selection
- B7. : quantity selection
- B8. : scroll arrow
- B9. Selectable drinks (press on the scrolling arrow  or  to see all the drinks)
- B10. : scroll arrow
- B11. Customisable profiles (see "Memorising your personal profile")

Description of the accessories

(page 3 - C)

- C1. "Total Hardness Test" indicator paper
- C2. Ground coffee measure
- C3. De-scaler
- C4. Water softener filter (certain models only)
- C5. Cleaning brush
- C6. Hot water/steam spout
- C7. Connection nozzle cover

Description of the milk container

(page 3 - D)

- D1. Froth adjustment and CLEAN function dial
- D2. Lid with milk frother
- D3. Milk container
- D4. Milk intake tube
- D5. Adjustable frothed milk spout
- D6. Thermal casing
- D7. Lid release buttons

PRELIMINARY OPERATIONS

Checking the appliance



After removing the packaging, make sure the product is complete and undamaged and that all accessories are present. Do not use the appliance if it is visibly damaged. Contact customer services Technical Assistance.

SETTING UP THE APPLIANCE



Please note:

- Coffee has been used to factory test the appliance and it is therefore completely normal to find traces of coffee in the mill. The machine is, however, guaranteed to be new.
- You should customise water hardness as soon as possible following the instructions in section "Setting water hardness".

1. Connect the appliance to the mains electricity supply (fig. 1) and make sure the main switch (A19) on the side of the appliance is pressed down (fig. 2);
2. SELECT LANGUAGE (setting language): press  (B10) or  (B8) until the flag corresponding to the required language appears on the display (B), then press the flag;

To proceed follow the instructions indicated on the appliance display:

1. FILL WATER TANK WITH FRESH WATER: remove the water tank (A12) (fig. 3), open the lid (fig. 4), fill to the MAX line (marked on the inside of the tank) with fresh water (fig. 5); close the lid and put the tank back into the appliance (fig. 6);
2. INSERT WATER OUTLET: Check that the hot water/steam spout (C6) is inserted on the connection nozzle (A10) (fig. 7) and place a container with a minimum capacity of 100 ml underneath (fig. 8);
3. WATER CIRCUIT EMPTY PRESS OK TO START FILLING PROCESS is shown on the display;
4. Press  to confirm: the appliance delivers water from the spout (fig. 8) then goes off automatically.

The coffee machine is now ready for normal use.

Please note:

- The first time the appliance is used, it needs to make 4-5 cappuccinos before it starts to give satisfactory results.
- On first use the water circuit is empty, the machine could therefore be very noisy: the noise will lessen as the circuit fills up.
- When making the first 5-6 cappuccinos, it is normal to hear the noise of boiling water: after this the noise will lessen.
- To improve the performance of the appliance, we recommend installing a water softener filter (C4) as described in section "Water softener filter". If your model is not equipped with a filter, it is possible to request one from Authorised Customer Service Centres.

TURNING THE APPLIANCE ON

Please note:

Before turning the appliance on, make sure the main switch (A23) is pressed (fig. 2). Each time the appliance is turned on, it performs an automatic preheat and rinse cycle which cannot be interrupted. The appliance is ready for use only after completion of this cycle.

Danger of burns!

During rinsing, a little hot water comes out of the coffee spouts (A13) and is collected in the drip tray (A14) underneath. Avoid contact with splashes of water.

- To switch the appliance on, press the button  (A7-fig. 9): message HEATING UP PLEASE WAIT, is shown on the display.
- When heating is complete, the message changes to: RINSING HOT WATER RUNNING; As well as heating the boiler, the appliance also continues to allow hot water to run in the internal pipework as they also heat up.

The appliance is at the desired temperature when the main screen, homepage, appears.

TURNING THE APPLIANCE OFF

Every time the appliance is turned off, it automatically carries out a rinse if it has made a coffee.

Danger of burns!

During rinsing, a little hot water flows from the coffee spouts (A13). Avoid contact with splashes of water.

- To turn the appliance off, press the button  (A7-fig. 9).
- The message TURNING OFF PLEASE WAIT is shown on the display: if needed the appliance performs a rinse cycle and then goes off (standby).

Please note:

If the appliance is not used for long periods, disconnect from the electricity supply as follows:

- first turn the appliance off by pressing the button  (fig. 9);
- release the main switch (A23) situated on the side of the appliance (fig. 2).

Important!





Never press the main switch while the appliance is on.

MENU SETTINGS

Rinsing

Use this function to supply hot water from the coffee spouts (A13) to clean and heat the appliance's internal circuit. Place a container with a minimum capacity of 100ml under the coffee and hot water spouts (fig. 8).

To enable the function, proceed as follows:

1. Press  (B2) to enter the menu;
2. Press  (B10) or  (B8) until the display shows (B)  RINSING;
3. Press  to start rinsing.

Danger of burns!

Do not leave the appliance unattended while hot water is being delivered.

1. After a few seconds, hot water comes out of the coffee

spout which cleans and heats the internal circuit of the appliance: the following message is shown on the display RINSING HOT WATER RUNNING as well as a progress bar which fills up as the preparation progresses;

- To stop the rinsing cycle, press stop or wait for rinsing to stop automatically.

Please note:

- If the appliance is not used for more than 3-4 days, when switched on again, we strongly recommend doing 2/3 rinses before use;
- After rinsing, it is normal that there is some water in the grounds container (A10).

De-scaling

For instructions on de-scaling, see section "De-scaling".

Water filter

For instructions on how to install the filter (C4), see section "Water softener filter".

Beverages settings

In this section, you can consult your customised settings and, if you wish, reset the default values for each beverage.

- Press (B2) to enter the menu;
- Press (B10) or (B8) until DRINKS SETTINGS appears on the display (B);
- Press : The values for the first beverage appear on the display;
- The reference user profile is highlighted on the display. The values are shown on the vertical bars: the manufacturer default value is indicated by the symbol while the current set value is highlighted by the filled part of the vertical bar;
- To go back to the settings menu, press esc .
To scroll and display the beverages, press next;
- To return to the default manufacturer values for the beverage shown on the display, press RESET;
- CONFIRM RESET?: to confirm, press ok (to cancel, press esc);
- RETURN TO FACTORY: press ok.

The beverage has been reset to the default values. Continue with the other beverages, or go back to the settings menu.

Please note:

- To change the beverages for another profile, go back to the homepage, select the required profile (B11) and repeat the procedure.
- To reset all the beverages in the profile to the default val-

ues, see paragraph "Manufacturer Default values".

Set time

To adjust the time on the display (B), proceed as follows:

- Press (B2) to enter the menu;
- Press (B10) or (B8) until the display (B) shows SET TIME;
- Press : The time setting panel appears on the screen;
- Press or corresponding to the hours and minutes until the current time is displayed;
- To confirm, press ok (to cancel, press esc), then press esc to go back to the homepage.

The time is now set.

Auto-start

The auto-start time can be set in order to have the appliance ready at a certain time (for example in the morning) so that it can immediately make coffee.

Please note:

To enable this function, the time must already be set correctly, see paragraph "Set time

To enable auto-start, proceed as follows:

- Press (B2) to enter the menu;
- Press (B10) or (B8) until the display (B) shows AUTO-START;
- Select the function by pressing : The time setting panel appears on the screen;
- Press or corresponding to the hours and minutes until the required auto-start time is displayed;
- Press OFF or ON to enable or disable auto-start.
- To confirm, press ok (to cancel and go back to the settings menu press esc), then press esc to go back to the homepage.

The auto-start time is now set and the corresponding symbol is displayed next to the time to indicate that the function has been enabled.







Please note:

When the appliance is turned off using the main switch (A21), the auto-start setting if enabled, is lost.

Auto-off (standby)









Auto-off can be set so that the appliance goes off after 15 or 30 minutes, or 1, 2 or 3 hours of no use.

To programme Auto-off, proceed as follows:

1. Press  (B2) to enter the menu;
 2. Press  (B10) or  (B8) until the display (B)  shows AUTO-OFF, together with the current selection (15 or 30 minutes, or 1, 2 or 3 hours);
 3. Press  on the display to select the required value;
 4. Press  to go back to the homepage.
- Auto-off is now programmed.

Cup warmer









To warm the cups before making coffee, it is possible to activate the cup warmer (A24) and put it above the cups.

1. Press "" (B2) to enter the menu;
2. Press  (B10) or  (B8) until the display (B) shows " CUP WARMER";
3. Press  to activate-  or de-activate-  the cup warmer.
4. Press "" to go back to the homepage.

Energy saving







Use this function to enable or disable energy saving mode. When enabled, the function guarantees reduced energy consumption in compliance with European regulations. When it is disabled, warming time is reduced.

To disable or enable "Energy Saving", proceed as follows:

1. Press  (B2) to enter the menu;
2. Press  (B10) or  (B8) until  ENERGY SAVING appears on the display (B);
3. Press  to enable-  or disable-  energy saving.
4. Press  to go back to the homepage.

Coffee temperature

To modify the temperature of the water supplied to make the coffee, proceed as follows:









1. Press  (B2) to enter the menu;
2. Press  (B10) or  (B8) until the display (B)  shows COFFEE TEMPERATURE together with the current selection (LOW, MEDIUM, HIGH, OR MAX);
3. Press  to select the required temperature;
4. Press  to go back to the homepage.

Water hardness

For instructions related to setting water hardness, see section "Setting water hardness".









Selecting the language

To modify the language of the display (B), proceed as follows:

1. Press  (B2) to enter the menu;
2. Press  (B10) or  (B8) until the display shows  SET LANGUAGE;
3. Press  : press  or  until the flag corresponding to the required language is shown and then select it;
4. Press  2 times to go back to the homepage.

Sound notification









This enables or disables the beep emitted by the machine each time an icon is pressed or an accessory is inserted/removed. To disable or enable the beep, proceed as follows:

1. Press  (B2) to enter the menu;
2. Press  (B10) or  (B8) until the display (B) shows  BEEP;
3. Press  to enable-  or disable-  the sound notification;
4. Press  to go back to the homepage.

Light

This function enables or disables the lights (A6). The cup lights (A18) come on each time coffee beverages are produced, hot milk is made and during each rinse cycle and turn off after a few seconds.

To disable or enable this function, proceed as follows:





1. Press  (B2) to enter the menu;
2. Press  (B10) or  (B8) until the display (B) shows  LIGHT;
3. Press  to enable-  or disable-  the cup lighting;
4. Press  to go back to the homepage.

 **Please note:** The lighting to illuminate the interior compartment A6 comes on when the appliance is turned on.

Models with knobs: it is possible to enable or disable the lights (A6) by turning the  knob (A11).

Demo mode DEMO mode



By enabling this mode, the main functions of the machine are shown on the display:

1. Press  (B2) to enter the menu;
2. Press  (B10) or  (B8) until the display shows DEMO mode DEMO MODE;
3. Press "DEMO mode" to start the demo;
4. To exit from the DEMO MODE, first turn the appliance off by pressing the button  (A7). Press again the button  to go back to the homepage.

Default values









This resets all menu settings and programmed quantities back to the default values (with the exception of the language which remains as set).

To reset the default values, proceed as follows:

1. Press  (B2) to enter the menu;
2. Press  (B10) or  (B8) until the display (B) shows  DEFAULT VALUES. Press ;
3. Press  RESET ALL to reset all the profiles to the original parameters, otherwise select the required profile (e.g. USER1);
4. RETURN TO FACTORY SETTINGS? RESET ALL: press  ok to confirm (or  esc to leave parameters unaltered);
5. FACTORY SETTINGS SET : press  ok to confirm.

Statistics

This function displays statistical data relating to the machine. To display the statistics, proceed as follows:





































1. Press  (B2) to enter the menu;
2. Press  (B10) or  (B8) until the display (B) shows  STATISTICS ;
3. Press  : it is possible to check all the available statistics by pressing  or ;
4. Press  esc : to go back to the homepage.

MAKING COFFEE

(see recipes on page 30)

Selecting the coffee aroma

























Select the required aroma from the homepage by pressing  AROMA (B6):

	(see "Making coffee using pre-ground coffee")
     	AROMA EXTRA LIGHT
     	LIGHT AROMA
     	MEDIUM AROMA
     	STRONG AROMA
     	X-STRONG AROMA
     	Custom (if programmed) / Standard

After delivering the beverage, the aroma setting is reset to the  value.

Selecting the coffee quantity

From the homepage select the required quantity of coffee in the cup by pressing  QUANTITY (B7):



    	SMALL SIZE (SMALL)
    	MEDIUM SIZE (MEDIUM)
    	LARGE SIZE (LARGE)
    	X-LARGE SIZE (EXTRA LARGE)
    	Custom quantity (if programmed) / Standard quantity

After delivering the beverage, the quantity setting is reset to the  value.



Making coffee using coffee beans



Do not use green, caramelised or candied coffee beans as they could stick to the coffee mill and make it unusable.

1. Fill the beans container (A16) (fig. 12) with coffee beans;
2. Place a cup under the coffee spout (A13);
3. Lower the spout so that it is as near as possible to the cup (fig. 13); this helps achieve a better cream;
4. Press  (B10) or  (B8) until the required coffee is displayed;
5. Then select your required coffee from the homepage:
 - ESPRESSO
 - DOPPIO+
 - COFFEE
 - LONG
 - 2 X ESPRESSO
 - AMERICANO
6. Preparation begins and the display (B) shows the image of the selected beverage together with a progress bar which gradually fills as preparation proceeds.



- It is possible to prepare 2 cups of ESPRESSO coffee at the same time by also pressing X2  during preparation of 1 ESPRESSO (the image remains shown on the display for a few seconds at the start of preparation).
- While the machine is making coffee, delivery can be interrupted at any time by pressing  STOP.
- As soon as delivery has ended, to increase the quantity of coffee in the cup, just press  extra : once the desired

quantity is reached, press  stop.
Once the coffee has been made, the appliance is ready to make the next beverage.

 **Please note:**

Various alarm messages may be displayed while using the appliance (FILL TANK, EMPTY GROUNDS CONTAINER, etc.). Their meaning is explained in section "Displayed messages".

- For hotter coffee, see paragraph "Tips for a hotter coffee".
- If the coffee comes out in drops, too weak and not creamy enough or too cold, read the tips in section "Adjusting the coffee mill" and the "Troubleshooting" chapter.
- Preparation of each coffee can be customised (see sections "Customising beverages" and "Memorising your personal profile").
- If "Energy Saving" mode is active, the first coffee may take a few seconds before it is delivered.



Making coffee using pre-ground coffee

 **Important!**



- Never add pre-ground coffee when the machine is off in order to avoid it spreading through the inside of the machine and making it dirty. This could damage the appliance.
- Never use more than 1 level measure (C2) or it could dirty the inside of the coffee machine or block the funnel (A4).

 **Please note:**

If you use pre-ground coffee, you can only make one cup of coffee at a time.

1. Repeat Press  AROMA (B6) until the display (B) shows  (pre-ground).
2. Open the cover (A15) and the pre-ground door (A23).
3. Make sure the funnel (A21) is not blocked, then add one level measure of pre-ground coffee (fig. 14).
4. Place a cup under the coffee spouts (A13) (fig. 13).
5. Then select your required coffee (ESPRESSO, COFFEE, LONG etc.) from the homepage;
6. Preparation begins and the image of the selected beverage appears on the display, together with a progress bar which gradually fills as preparation progresses.

 **Please note:**

- While the machine is making coffee, delivery can be interrupted at any time by pressing  stop.
- As soon as delivery has ended, to increase the quantity of coffee in the cup, just press  extra: once the desired quantity is reached, press  stop.

Once the coffee has been made, the appliance is ready to make the next beverage.

 **Important!** Making LONG coffee  :

Halfway through preparation, the display will show message ADD PRE-GROUND COFFEE, MAXIMUM ONE MEASURING CUP. Add one level measure of pre-ground coffee and press  ok .

Adjusting the coffee mill

The coffee mill should not require adjusting, at least initially, because it has already been set by default in order to prepare coffee correctly. However, if after making the first few coffees you find that the coffee is either too weak and not creamy enough or delivery is too slow (a drop at a time), this can be corrected by adjusting the grinding adjustment dial (fig. 11).

 **Please note:**

The grinding adjustment dial must only be turned when the coffee mill is in operation during the initial phase of coffee preparation.



If the coffee comes out too slowly or does not come out at all, a message will be shown GROUND TOO FINE. ADJUST GRIND LEVEL, turn the coffee mill dial one or two clicks clockwise.





For fuller bodied creamier coffee, turn one click anticlockwise towards 1 (do not turn more than one click at a time otherwise the coffee could come out one drop a drop at a time).

The effect of these adjustments will only be evident after at least 2 cups of coffee have been delivered. If this adjustment does not obtain the desired result, repeat the correction by turning the dial another click.

Tips for a hotter coffee

For hotter coffee, it is recommended to:

- carry out a rinse cycle by selecting the "Rinsing" function in the settings menu (paragraph "Rinsing ");
- warm the cups with hot water (using the hot water function, see section "hot water supply");
- increase the coffee temperature in the settings menu (see section "Coffee temperature ").

MAKING MILK-BASED HOT DRINKS

(see recipes on page 31)

 **Please note:**

To avoid milk with little froth or large bubbles, always clean the

milk container lid (D2) and hot water connection nozzle (A10) as described in sections "Cleaning the milk container after use", "Cleaning the milk container" and "Cleaning the hot water/steam connection nozzle".

Filling and attaching the milk container

1. Remove the lid (D2) (fig. 15);
2. Fill the milk container (D3) with a sufficient quantity of milk, not exceeding the MAX level marked on the container (fig. 16). Each mark on the side of the container corresponds to about 100 ml of milk;



Please note:

- For a denser and more even froth, you must use skimmed or partially skimmed milk at refrigerator temperature (about 5°C).
- If "Energy Saving" mode is enabled, there may be a few seconds delay before the beverage is delivered.

1. Make sure the milk intake tube (D4) is correctly inserted in the bottom of the milk container lid (fig. 17);
2. Place the lid back on the milk container;
3. Remove the hot water/steam spout (C6) (fig. 18);
4. By pushing the bottom attach the milk container (D) to the nozzle (A10) (fig.19): the machine will let out a noise signal (if the sound notification function is enabled);
5. Place a sufficiently large cup under the coffee spouts (A13) and frothed milk spout (D5); adjust the length of the milk spout, to move it nearer to the cup, simply pulling it downwards (fig. 20).
5. Follow the instructions below for each function.

Adjusting the amount of froth

Turn the froth adjustment dial (D1) on the milk container lid, to adjust the amount of froth on the milk delivered while making the drinks. Follow the tips in the table below:

Dial position	Description	Recommended for...
	No froth	CAFFE LATTE / MILK (hot milk)
	Min. froth	LATTE MACCHIATO
	Max. froth	CAPPUCCINO / MILK (frothed milk)



Making milk-based drinks automatically

1. Fill the milk container (D) and attach it as described above.
 2. Select the required beverage from the homepage:
- CAPPUCCINO

- LATTE MACCHIATO
 - CAFFE LATTE
 - HOT MILK
 - CAPPUCCINO+
 - ESPRESSO MACCHIATO
 - FLAT WHITE
 - CAPPUCCINO MIX
3. On the display (B) the machine recommends turning the foam adjustment dial (D1) based on the foam requirements for the original recipe: therefore turn the dial on top of the milk container lid (D2) and confirm the selection by pressing  ok.
 4. After a few seconds, preparation begins automatically and an image of the selected beverage appears on the display, together with a progress bar which gradually fills as preparation progresses.



Please note: general indications when preparing all milk based drinks

-  ESC: press to interrupt preparation completely and go back to the homepage.
-  STOP: press to interrupt milk or coffee delivery and move on to the next delivery (if applicable) to complete the beverage.
- At the end of delivery, to increase the quantity of coffee in the cup, press  extra .
- Preparation of each milk based drink can be customised (see sections "Customising beverages" and "Memorising your personal profile").
- Do not leave the milk container out of the fridge for a long time: as the temperature increases (5°C ideal), the quality of the foam decreases.

Once the coffee has been made, the appliance is ready to make the next beverage.

Cleaning the milk container after use



Danger of burns!

The following cleaning operations should be performed each time a milk beverage is delivered. When cleaning the internal tubes of the milk container, a little hot water and steam leak out of the frothed milk spout (D5). Avoid contact with splashes of water. Each time a milk function is used, TURN MILK FROTH ADJUSTMENT KNOB TO CLEAN TO START CLEANING appears on the display and the milk frother lid must be cleaned:

1. Leave the milk container (D) in the machine (you do not need to empty it);
2. Place a cup or other recipient under the frothed milk spout (fig. 20);
3. Turn the foam adjustment dial (D1) to CLEAN (fig.21):

CLEANING MILK CONTAINER PLACE A CUP UNDER THE MILK OUTLET (FIG.22) appears on the display (B) together with a bar which gradually fills as cleaning proceeds. Cleaning stops itself automatically;

4. Turn the dial back to one of the froth selections;
5. Remove the milk container and always clean the steam connection nozzle (A10) with a clean cloth (fig. 23).



Please note:

- If a number of milk based drinks need to be made, only clean the milk container after preparing the last beverage. To proceed with making the next beverages, when the CLEAN message is displayed, press esc.
- If the milk container does not get cleaned, the symbol appears on the display as a reminder that the milk container needs cleaning.
- The milk container can be kept in the refrigerator.
- In some cases, to carry out the cleaning the appliance requires a short time to heat up.

DELIVERING HOT WATER



Danger of burns!

Do not leave the appliance unattended while hot water is being delivered.

1. Make sure the hot water/steam spout (C6) is attached correctly to the hot water/steam connection nozzle (A10);
2. Place a container under the spout (as close as possible to avoid splashes);
3. Select HOT WATER from the homepage. The corresponding image appears on the display (B), together with a progress bar which fills gradually as preparation proceeds;
4. The machine delivers hot water, then delivery stops automatically. To interrupt hot water delivery manually, press stop .



Please note:

- If "Energy Saving" mode is active, there may be a few seconds delay before hot water is delivered.
- Preparation of hot water can be customised (see sections "Customising beverages" and "Memorising your personal profile").

STEAM DELIVERY



Danger of burns!

Do not leave the appliance unattended while steam is being delivered.

1. Make sure the hot water/steam spout (C6) is attached cor-

rectly to the hot water/steam connection nozzle (A10);

2. Fill a container with the liquid to be heated or frothed and immerse the hot water/steam spout in the liquid;



3. Select " STEAM" from the homepage. The corresponding image appears on the display (B), together with a progress bar which fills gradually as preparation proceeds and after a few seconds, steam to heat the liquid is delivered from the hot water/steam spout;
4. When the required temperature or level of froth is reached, interrupt steam delivery by pressing stop ;



Important!

Always stop steam delivery before extracting the container containing the liquid to avoid burns from splashes.



Please note:

If "Energy saving" mode is active, there may be a few seconds delay before steam is delivered.

Tips for using steam to froth milk

- When choosing the size of the container, bear in mind that the liquid doubles or triples in volume.
- For a richer denser froth, use skimmed or partially skimmed milk at refrigerator temperature (about 5°C).
- For a creamier froth, rotate the container with slow movements in an upward motion.
- To avoid milk with poor froth or large bubbles, always clean the spout (C6) as described in the following paragraph.







Cleaning the hot water/steam spout after use

Always clean the hot water/steam spout (C6) after use to avoid the build-up of milk residues and prevent it from clogging.

1. Place a container under the hot water/steam spout and let a little water out (see section "Delivering hot water"). Then stop the delivery of hot water by pressing stop .
2. Wait a few minutes for the hot water/steam spout to cool down; then extract it (fig. 18). Hold the spout steady with one hand and with the other, turn and detach the cappuccino maker pulling it downwards (fig. 24).
3. Also remove the steam connection nozzle by pulling it downwards (fig. 24).
4. Check the hole in the connection nozzle is not blocked. If necessary, clean using a toothpick.
5. Wash all parts of the spout thoroughly with a sponge and warm water.
6. Attach the connection nozzle and the cappuccino maker onto the spout by pushing it upwards and turning it clockwise until it is secure.

CUSTOMISING BEVERAGES



The aroma (for drinks where required) and length of the drinks can be customised.

1. Make sure that the profile for which customising the drink is required is active: it is actually impossible to select the drinks for all 6 profiles ;
2. From the homepage, press  (B1);
3. Choose the beverage you wish to customise in order to access the customising screens: the relative accessories must be inserted;
4. (Beverages with coffee only) CHOOSE COFFEE AROMA LEVEL: Select the required aroma by pressing  or  and press  ok ;
5. CUSTOMISING COFFEE (OR WATER) QUANTITY, PRESS STOP TO SAVE: Preparation begins and the appliance displays the quantity customising screen in the form of a vertical bar. The star alongside the bar represents the current quantity set.
6. When the amount reaches the minimum quantity you can set, the display shows  stop .
7. Press  stop when the required quantity in the cup is reached.
8. SAVE NEW SETTINGS? : Press YES or NO.

The appliance confirms if the values have been saved or not (depending on the previous selection): press  ok .

The appliance goes back to the homepage.



Please note:

- Milk based drinks: the coffee aroma is saved first, followed by the quantity of first milk, then coffee;
- Hot water: the appliance supplies hot water: press  stop to save the desired quantity.
- It is possible to come out of programming by pressing  esc : the values will not be saved.

MEMORISING YOUR PERSONAL PROFILE

The appliance allows you to memorise 6 different profiles, each associated with a different icon.

In every profile the customised beverages aroma and quantity values are saved (see section "Customising beverages ) and the order in which all the beverages are displayed is based on the frequency of selection.

To select or enter a profile, press on the profile currently in use (B11), press  (B10) or  (B8) until the required profile is displayed, then press on the profile.

Please note:

- Profile  GUEST : select this profile to deliver beverages

with the default settings.

CLEANING

Cleaning the machine

The following parts of the machine must be cleaned regularly:

- appliance internal circuit;
- coffee grounds container (A4);
- drip tray (A14);
- water tank (A12);
- coffee spouts (A13);
- pre-ground coffee funnel (A21);
- infuser (A5), accessible after opening the service door (A2);
- milk container (D);
- hot water/steam connection nozzle (A10);
- control panel (B).

Important!

- Do not use solvents, abrasive detergents or alcohol to clean the coffee machine. It is not necessary to use chemical products to clean the machine.
- None of the components of the appliance can be washed in a dishwasher with the exception of the milk container (D).
- Do not use metal objects to remove encrustations or coffee deposits as they could scratch metal or plastic surfaces.

Cleaning the appliance internal circuit

If the appliance is not used for more than 3/4 days, before using it again, we strongly recommend switching it on and:

1. performing 2/3 rinse cycles by selecting the "Rinse" function (paragraph "Rinsing ");
2. delivering hot water for a few seconds (section "Delivering hot water").

Please note:

After cleaning, it is normal for the grounds container (A4) to contain water.

Cleaning the coffee grounds container

When the display (B) shows the message EMPTY GROUND CONTAINER (fig. 26) the grounds container must be emptied and cleaned. The appliance cannot be used to make coffee until the grounds container (A4) has been cleaned. Even if not full, the empty grounds container message is displayed 72 hours after the first coffee has been prepared (for the 72 hours to be calculated correctly, the machine must never be turned off with the main switch).

To clean (with the machine on):

1. Open the bottom door by rotating it downwards (fig. 25).
2. Open the door.
3. Remove the drip tray (A14) (fig. 27), empty and clean it.

- Carefully empty and clean the coffee grounds container (A4) taking care to remove all the residue that can be deposited on the bottom: the brush provided (C5) features a spatula especially for this job.



Important!

When removing the drip tray it is obligatory to always empty the grounds container even if it contains few grounds. If this is not done, when you make the next coffees, the grounds container may fill up more than expected and clog the machine.

Cleaning the drip tray



Important!

The drip tray (A14) is fitted with a level indicator (red) showing the level of water it contains (fig. 28).

Before the indicator protrudes from the cup tray (A1), the drip tray must be emptied and cleaned, otherwise the water may flow over the edge and damage the appliance, the surface it rests on or the surrounding area.

To remove the drip tray, proceed as follows:

- Open the door (fig. 25). Remove the drip tray and coffee grounds container (A4) (fig. 27);
- Empty the drip tray and grounds container and wash them;
- Replace the drip tray complete with grounds container.

Cleaning the inside of the coffee machine



Danger!

Before cleaning internal parts, the machine must be turned off (see section "Turning the appliance off") and unplugged from the mains power supply. Never immerse the coffee machine in water.

- Check regularly (about once a month) that the inside of the appliance (accessible after removing the drip tray - A14) is not dirty.
- If necessary, remove coffee deposits with the brush (C5) supplied and a sponge. Remove all the residues with a vacuum cleaner (fig. 29).

Cleaning the water tank

- Clean the water tank (A12) regularly (about once a month) and whenever you replace the water softener filter (C4) (if provided) with a damp cloth and a small amount of mild washing up liquid.: rinse carefully before filling and replacing the tank;
- Remove the filter (if present) and rinse with running water;
- Replace the filter (if provided), fill the tank with fresh water and replace the tank;
- (Models with water softener filter only) Deliver about

100ml of hot water to reactivate the filter.

Cleaning the coffee spouts

- Clean the coffee spouts (A13) regularly with a sponge or cloth (fig. 31);
- Check that the holes in the coffee spouts are not blocked. If necessary, remove coffee deposits with a toothpick (fig. 30).

Cleaning the pre-ground coffee funnel

Check regularly (about once a month) that the pre-ground coffee funnel (A21) is not blocked. If necessary, remove coffee deposits with the brush (C5) supplied.

Cleaning the infuser

The infuser must be cleaned at least once a month.



Important! The infuser (A5) must not be removed when the appliance is on. Do not use force to remove the infuser.

- Make sure the machine is correctly turned off (see "Turning off").
- Open the service door.
- Remove the drip tray and waste coffee container (fig. 27).
- Press the two coloured release buttons inwards and at the same time pull the infuser outwards (fig. 32).



Important! Do not use washing up liquid to clean the infuser to avoid removing the lubricant applied to the inside of the piston.

- Soak the infuser in water for about 5 minutes, then rinse.
- After cleaning, replace the infuser (A5) by sliding it onto the internal support and pin at the bottom, then push the PUSH symbol fully in until it clicks into place (fig. 33).



Please note carefully: If you encounter difficulty inserting the infuser, (before inserting it) you must adapt it to the right dimension by pressing it forcefully from the bottom and top as shown in the figure 34.

- Once inserted, make sure the two coloured release buttons have snapped out (fig. 35).
- Replace the drip tray and waste coffee container.
- Close the service door.

Cleaning the milk container (D)

Clean the milk container after each time you prepare milk, as described below:

- Lift and remove the lid (D2);
- Extract the milk container (D3) from the thermal casing

(D6), holding it by the two side grips.



Important!

The thermal casing must not be filled or immersed in water: to clean it wipe with a damp cloth.

3. Remove the milk spout (D5) and intake tube (D4).
4. Turn the froth adjustment dial clockwise to the "INSERT" position (fig. 36) and pull off.
5. Wash all the components of the frother thoroughly with hot water and mild washing-up liquid. All components and the container are dishwasher safe, placing them in the top basket of the dishwasher.
Pay particular attention to check in the hollow and groove under the dial (fig. 37) that no milk residues remain: scrape any residue from the groove with a toothpick.
6. Rinse inside the froth adjustment dial seat (fig. 38) and the milk frother connector hole using running water.
7. Check as well that the intake tube and spout are not clogged with milk residues.
8. Replace the dial, lining up the arrow with the word INSERT, the spout and milk intake tube.
9. Place the milk container in the thermal casing.
10. Place the lid back on the milk container.

Cleaning the hot water/steam connection nozzle

Each time you prepare milk, clean the connection nozzle (A10) with a clean cloth to remove milk residues deposited on the seals (fig. 23).

DESCALING



Important!

- Before use, read the instructions and the labelling on the de-scaler packaging.
- You should use de-scaler authorised by the manufacturer only. Using unsuitable de-scaler and/or performing de-scaling incorrectly may result in faults not covered by the manufacturer's guarantee.

De-scale the appliance when the display (B) shows message DESCALING NEEDED PRESS OK TO START (~45 min) : to de-scale immediately, press OK and follow the instructions from point 4.

To postpone de-scaling to another time, press esc : on the display the symbol is a reminder that the appliance needs to be de-scaled (the message will be re-proposed every time the machine is switched on).

To access the de-scaling menu:

1. Press (B2) to enter the menu;

2. Press (B10) or (B8) until the display shows ;
DESCALE;
3. Press to start the de-scaling cycle then follow the instructions on the display;
4. REMOVE WATER FILTER (fig. 39): extract the water tank (A12), remove the water softener filter (C4) (if present) and empty the water tank. Press next;
5. ADD DESCALER (UP TO LEVEL A) AND WATER (UP TO LEVEL B) (fig. 40): Pour the de-scaler into the tank up to the level A marked inside the tank (equal to one 100 ml pack); then add water (one litre) up to level B; and put the water tank back in. Press next ;
6. EMPTY GROUND CONTAINER AND DRIP TRAY (fig. 27): remove, empty and replace the drip tray (A14) and the ground container (A4). Press next ;
7. PLACE 2.5L CONTAINER UNDER OUTLET PRESS OK TO START DESCALING :
Place an empty container with a minimum capacity of 2.5 litres under the hot water/steam spout (C6) and coffee spouts (A13) (fig. 8);





Danger of burns!

Hot water flows out of the hot water/steam spout which contains acid. Take care to avoid contact with splashes of this solution.

8. Press OK to confirm that you have added the de-scaling solution. The display shows DESCALING PLEASE WAIT : the de-scale programme starts and the de-scaler liquid comes out of the hot water/steam and coffee spouts. A series of rinses and pauses is automatically carried out to remove all the scale residues from the inside of the coffee machine;

After about 25 minutes, de-scaling stops:

9. RINSE AND FILL WATER TANK UP TO MAX LEVEL (fig. 41): the appliance is now ready for a fresh water rinsing cycle. Empty the container used to collect the de-scaler solution and extract the water tank, empty, rinse under running water, fill with fresh water up to the MAX level and put back in the appliance;
10. PLACE 2.5L CONTAINER UNDER OUTLET PRESS OK TO START RINSING: Place the container used to collect the de-scaler solution empty under the coffee spouts and hot water/steam spout (fig. 8) again and press OK ;
11. Hot water is delivered first from the coffee spouts and the display shows RINSING PLEASE WAIT ;
12. When the water in the tank has run out, empty the container used to collect the rinsing water;
13. (If the filter is installed) INSERT FILTER INTO ITS HOUSING (fig. 42). Press next and extract the water tank, reinsert the water softener filter if removed previously;

14. RINSE AND FILL WATER TANK UP TO MAX LEVEL (fig. 41): Fill the tank up to the MAX level with fresh water;
15. INSERT WATER TANK (fig. 6): Put the water tank back in the appliance;
16. PLACE 2.5L CONTAINER UNDER OUTLET PRESS OK TO START RINSING :
Place the empty container used to collect the de-scaler solution under the hot water/steam spout (fig. 8) and press  ok ;
17. Hot water is delivered from the hot water/steam spout and RINSING PLEASE WAIT is displayed.
18. EMPTY DRIP TRAY (fig. 27): At the end of rinsing, remove, empty and replace the drip tray (A14) and grounds container (A4): press  next ;
19. For a few seconds DESCAL COMPLETE will be shown on the display; the appliance turn off.

De-scaling is complete.



Please note:

- If the de-scaling cycle is not completed correctly (e.g. no electricity) we recommend repeating the cycle;
- After de-scaling, it is normal for the grounds container (A4) to contain water.
- If the water tank has not been filled to the max level, at the end of de-scaling, the appliance requests a third rinse to guarantee that the de-scaler solution has been completely eliminated from the machine's internal circuits. Before starting rinsing, remember to empty the drip tray;
- The appliance may request de-scaling cycles at very short intervals. This is normal and due to the appliance's advanced control system

PROGRAMMING WATER HARDNESS

The DESCALING NEEDED - PRESS OK TO START (~45 min)  message is displayed after a period of time established according to water hardness.



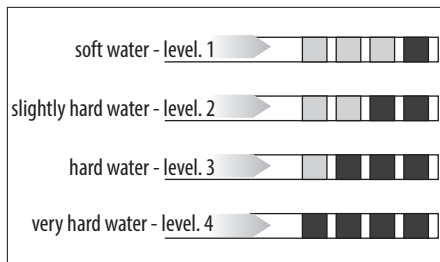

The appliance default is pre-set in manufacturing at "level 4" hardness. The machine can also be programmed according to the hardness of the mains water in the various regions so that the machine needs to be de-scaled less often.

Measuring water hardness

1. Remove the "Total hardness test" indicator paper (C1) provided from its packaging, attached to the instructions.
2. Immerse the paper completely in a glass of water for about one second.
3. Remove the paper from the water and shake lightly. After about a minute, 1, 2, 3, or 4 red squares form, depending on the hardness of the water. Each square corresponds to one level.



Setting water hardness

1. Press  (B2) to enter the menu;
2. Press  (B10) or  (B8) until the display (B) displays  WATER HARDNESS ;
3. To change the level selected, press the symbol itself until the required level is displayed (Level 1 = soft water; Level 4 = very hard water);

Press  esc to go back to the homepage.







The machine is now reprogrammed with the new water hardness setting.

WATER SOFTENER FILTER

Some models are fitted with a water softener filter (C4): if your model is not equipped with one, we recommend buying one through an authorised customer service centre.

To use the filter correctly, follow the instructions below.

Installing the filter

1. Remove the filter (C4) from the packaging;
2. Press  (B2) to enter the menu;
3. Press  (B10) or  (B8) until the display shows  WATER FILTER ;
4. Press  ;
5. TURN THE DATE INDICATOR UNTIL THE NEXT 2 MONTHS ARE DISPLAYED (fig. 43):
turn the date indicator disk until the next two months of use are displayed. Press  next ;



Please note:

the filter lasts about two months if the appliance is used normally, if the coffee machine is left unused with the filter installed, it will last a maximum of 3 weeks.

1. FILL FILTER WITH WATER UNTIL IT'S COMPLETELY FILLED (fig. 44): To activate the filter, run tap water through the hole in the filter as shown in the figure until water comes out of the openings at the side for more than a minute. Press  next ;

2. Extract the tank (A12) from the appliance and fill with water.
3. **IMMERSE FILTER IN THE WATER TANK LETTING AIR BUBBLES ESCAPE** (fig. 45): Insert the filter in the water tank and immerse it completely for about ten seconds, sloping it and pressing it lightly to enable the air bubbles to escape. Press next ;
4. **INSERT FILTER INTO ITS HOUSING AND PUSH IT DOWN TO BOTTOM**: Insert the filter in the filter housing (fig. 42) and press as far as it will go. Press next ;
5. **INSERT WATER TANK** : Close the tank with the lid (A15), then replace the tank in the machine.
6. **PLACE 0.5L CONTAINER UNDER OUTLET, PRESS OK TO FILL FILTER** (fig. 8): place the container under the hot water/steam spout (C6) and press ok : delivery starts and stops itself automatically.

The symbol appears on the display alongside the time to indicate that the filter has been enabled. The coffee machine can now be used.

Replacing the filter

Replace the filter (C4) when the display (B) shows the message **REPLACE WATER FILTER, PRESS OK TO START** : to replace immediately, press ok and follow the instructions from point 4.

To postpone replacing the filter to another time, press esc : on the display the symbol is a reminder that the filter needs to be replaced.

To replace, proceed as follows:

1. Extract the water tank (A12) and exhausted filter;
2. Remove the new filter from the packaging;
3. Press (B2) to enter the menu;
4. Press (B10) or (B8) until the display shows WATER FILTER ;
5. Press ;
6. The display shows REPLACE FILTER ;
7. Press ;
8. Follow the operations described in the previous paragraph from point 5.

The filter is now active and the coffee machine can be used.

Please note:

After two months (see date indicator) or when the appliance has not been used for 3 weeks, you should replace the filter even if the message has not yet been displayed.

Removing the filter

If you want to use the appliance without the filter (C4), you must remove it and notify the appliance of its removal. Proceed as follows:

1. Extract the water tank (A12) and exhausted filter;
2. Press (B2) to enter the menu;
3. Press (B10) or (B8) until the display shows WATER FILTER ;
4. Press ;
5. On the display REMOVE FILTER appears;
6. Press ;
7. REMOVE FILTER? : press ok (or to go back to the settings menu, press esc) ;
8. FILTER REMOVED : the appliance has recognised the change. Press ok to go back to the homepage.

Please note:

After two months (see date indicator) or when the appliance has not been used for 3 weeks, you should remove/replace the filter even if the message has not yet been displayed.

TECHNICAL DATA

Voltage: 120V ~ 60 Hz max.

Absorbed power: 1350W



Pressure: 15 bar



Water tank capacity: 84.5 fl. oz / 2.5 litres

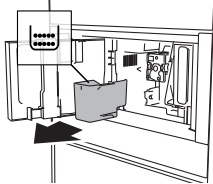
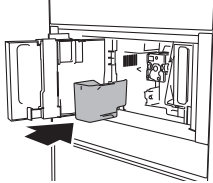
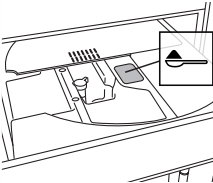

Size:LxHxD: 3.5 x 17.7 x 18.5 in / 597x450x470 mm



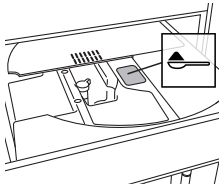
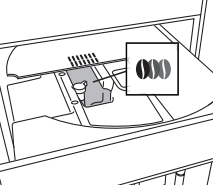
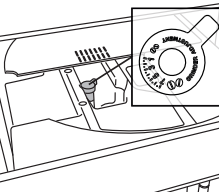



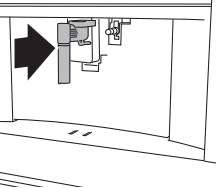
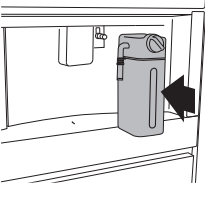
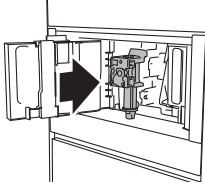
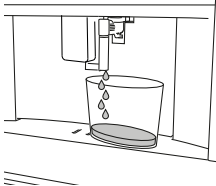

Net weight: 44 lb / 20 kg



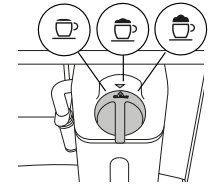







DISPLAYED MESSAGES

DISPLAYED MESSAGE	POSSIBLE CAUSE	REMEDY
<p>FILL WATER TANK WITH FRESH WATER</p> 	<p>Water in the tank (A12) is not sufficient.</p>	<p>Fill the tank with water and/or insert it correctly, pushing it as far as it will go until it clicks into place.</p>
<p>EMPTY GROUND CONTAINER</p> 	<p>The grounds container (A4) is full.</p>	<p>Empty the grounds container and drip tray (A14), clean and then replace them. Important: when removing the drip tray, the grounds container must always be emptied, even if it contains few grounds. If this is not done, when you make the next coffees, the grounds container may fill up more than expected and clog the machine.</p>
<p>INSERT GROUND CONTAINER</p> 	<p>After cleaning, the grounds container (A4), has not been replaced.</p>	<p>Remove the drip tray (A14) and insert the grounds container.</p>
<p>ADD PRE-GROUND COFFEE PRE-GROUND MAXIMUM ONE MEASURING CUP</p>  	<p>The "pre-ground coffee" function has been selected, but without placing any pre-ground coffee in the funnel (A21).</p> <p>The funnel (A21) for pre-ground coffee, is clogged.</p>	<p>Place pre-ground coffee in the funnel (fig. 14) and repeat delivery</p> <p>Empty the funnel with the help of the brush (C5) as described in par. "Cleaning the pre-ground coffee funnel".</p>

DISPLAYED MESSAGE	POSSIBLE CAUSE	REMEDY
<p>ADD PRE-GROUND COFFEE PRE-GROUND MAXIMUM ONE MEASURING CUP</p>  <p>✓ok</p>	<p>A LONG coffee with pre-ground coffee has been requested</p>	<p>Place pre-ground coffee in the funnel (A21) (fig. 14) and press ✓ok to continue and complete delivery.</p>
<p>FILL BEAN CONTAINER</p>  <p>↶esc</p>	<p>The coffee beans have run out.</p>	<p>Fill the beans container (A16 - fig.12).</p>
<p>GROUND TOO FINE. ADJUST GRIND LEVEL 1 CLICK WHILE IN OPERATION</p>  <p>↶esc</p>	<p>The grinding is too fine and the coffee is delivered too slowly or not at all.</p>	<p>Repeat coffee delivery and turn the grinding adjustment dial (fig. 11) one click clockwise towards number 7 while the coffee mill is in operation. If after making at least 2 coffees delivery is still too slow, repeat the correction procedure, turning the grinding adjustment dial another click (par. "Adjusting the coffee mill"). If the problem persists, make sure the water tank (A12) is fully inserted.</p>
<p>SELECT A Milder TASTE OR REDUCE PRE-GROUND COFFEE QUANTITY</p>  <p>↶esc</p>	<p>Too much coffee has been used.</p>	<p>Select a milder taste by pressing ☰ AROMA (B6) or reduce the quantity of pre-ground coffee (maximum 1 measure).</p>

DISPLAYED MESSAGE	POSSIBLE CAUSE	REMEDY
<p data-bbox="87 124 258 145">INSERT WATER OUTLET</p> 	<p data-bbox="329 124 624 177">The hot water spout (C6) is not inserted or is inserted incorrectly</p>	<p data-bbox="647 124 941 145">Insert the water spout as far as it will go.</p>
<p data-bbox="87 359 275 379">INSERT MILK CONTAINER</p> 	<p data-bbox="329 359 602 411">The milk container (D) is not inserted correctly.</p>	<p data-bbox="647 359 1028 379">Insert the milk container as far as it will go (fig. 19).</p>
<p data-bbox="87 619 253 639">INSERT BREWING UNIT</p> 	<p data-bbox="329 619 628 671">After cleaning the infuser has not been replaced.</p>	<p data-bbox="647 619 1031 671">Insert the infuser as described in par. "Cleaning the infuser".</p>
<p data-bbox="87 847 297 927">WATER CIRCUIT EMPTY PRESS OK TO START FILLING PROCESS</p>  <p data-bbox="225 1129 292 1161"> ok</p>	<p data-bbox="329 847 521 868">The water circuit is empty</p>	<p data-bbox="647 847 1031 959">Press  ok and allow water to drain out of the spout (C6): the flow will stop itself automatically. If the problem persists, make sure the water tank (A12) is fully inserted.</p>



DISPLAYED MESSAGE	POSSIBLE CAUSE	REMEDY
<p>PRESS OK TO START CLEANING PROCESS OR TURN MILK FROTH ADJUSTMENT KNOB</p> 	<p>The milk container has been inserted with the froth adjustment dial (D1) in the CLEAN position .</p>	<p>To proceed with the CLEAN function, press ok or turn the froth adjustment dial to one of the milk positions.</p>
<p>TURN THE MILK FROTH ADJUSTMENT KNOB TO START CLEANING</p> 	<p>Milk has been delivered recently and the tubes inside the milk container must be cleaned (D).</p>	<p>Turn the froth adjustment dial (D1) to CLEAN (fig. 21).</p>
<p>TURN THE MILK FROTH ADJUSTMENT KNOB TO MILK POSITION</p> 	<p>The milk container has been inserted with the froth adjustment dial (D1) in the CLEAN position.</p>	<p>Turn the dial to the required froth position.</p>
<p>DESCALING NEEDED PRESS OK TO START (~45MIN)</p> 	<p>Indicates that the machine must be de-scaled.</p>	<p>Press ok to start de-scaling or press esc to de-scale later. The de-scaling procedure described in section “De-scale” needs to be performed.</p>
<p>REPLACE WATER FILTER PRESS OK TO START</p> 	<p>The water softener filter (C4) is exhausted.</p>	<p>Press ok to replace or remove the filter, or esc to carry out the procedure later. Follow the instructions in section “Water softener filter”.</p>

DISPLAYED MESSAGE	POSSIBLE CAUSE	REMEDY
GENERAL ALARM: REFER TO USER MANUAL 	The inside of the appliance is very dirty.	Clean the inside of the appliance thoroughly, as described in section "Cleaning". If the message is still displayed after cleaning, contact an authorised Customer Service centre.
	Reminder that appliance needs de-scaling and/or the filter (C4) must be replaced.	The de-scaling procedure described in section "De-scale" needs to be performed as soon as possible and/or the filter needs replacing or removing as described in section "Water softener filter".
	Reminder that tubes inside the milk container (D) must be cleaned.	Turn the froth adjustment dial (D1) to CLEAN (fig. 21).
	Reminder that filter (C4) must be replaced.	Replace the filter or remove it as described in section "Water softener filter".
	Reminder that machine must be de-scaled.	The de-scaling procedure described in section "De-scale" needs to be carried out as soon as possible.
	Indicates that the auto-start function is enabled.	To disable the function, proceed as described in par. "Auto-start  ".
	Energy saving is enabled.	To disable energy saving, proceed as described in par. "Energy saving  ".
	Indicates that the filter (C4) has been enabled	To remove the filter, proceed as described in section "Water softener filter".
CLEANING PLEASE WAIT	The appliance has detected impurities in its internal circuits.	Wait for the appliance to be ready for use again and reselect the required beverage. Contact an Authorised Customer Service Centre if the problem persists.
MACHINE TOO HOT	Using the stirrers continuously for long periods may cause the appliance to overheat	Wait for the appliance to cool down.

TROUBLESHOOTING

Below is a list of some of the possible malfunctions.

If the problem cannot be resolved as described, contact Customer Services Technical Assistance.

PROBLEM	POSSIBLE CAUSE	REMEDY
The coffee is not hot.	The cups were not preheated.	Warm the cups by rinsing them with hot water (Please note! the hot water function can be used).
	The infuser has cooled down because 2/3 minutes have elapsed since the last coffee was made.	Before making the coffee, heat the infuser by rinsing using the rinse function (see par. "Rinsing  ").
	A low coffee temperature is set.	Set a hotter coffee temperature in the menu (see par. "Coffee temperature  ").
The coffee is weak or not creamy enough.	The coffee is ground too coarsely.	Turn the grinding adjustment dial one click anticlockwise towards number 1 while the coffee mill is in operation (fig. 11). Continue one click at a time until coffee delivery is satisfactory. The effect can only be noticed after delivering 2 coffees (see par. "Adjusting the coffee mill").
	The coffee is unsuitable.	Use coffee for espresso machines.
The coffee is delivered too slowly or a drop at a time.	The coffee is ground too finely.	Turn the grinding adjustment dial one click clockwise towards number 7 while the coffee mill is in operation (fig. 11). Continue one click at a time until coffee delivery is satisfactory. The effect can only be noticed after delivering 2 coffees (see par. "Adjusting the coffee mill").
Coffee does not come out of one or both of the spouts.	The coffee spouts (A13) are blocked.	Clean the spouts with a toothpick (fig. 30).
The appliance is not producing coffee	The appliance detects impurities in its system: the display shows "CLEANING IN PROGRESS".	Wait for the appliance to be ready for use again and reselect the required beverage. Contact an Authorised Customer Service Centre if the problem persists.
The appliance does not come on	It is not plugged into the socket.	Plug into the mains socket (fig. 1).
	The main switch (A21) is not turned on.	Press the main switch (fig. 2).
The infuser cannot be extracted	The appliance has not been turned off correctly	Turn the appliance off by pressing the  button (A7) (see section "Turning the appliance off").
At the end of de-scaling, the appliance requests a third rinse	During the two rinse cycles, the water tank (A12) was not filled to the MAX level	Follow the instructions displayed by the appliance, first emptying the drip tray (A14) to avoid the water overflowing.

PROBLEM	POSSIBLE CAUSE	REMEDY
The milk does not come out of the milk spout (D5)	The lid (D2) of the milk container (D) is dirty	Clean the milk container lid as described in par. "Cleaning the milk container".
The milk contains large bubbles and squirts out of the milk spout (D5) or there is little froth	The milk is not cold enough or is not semi-skimmed or skimmed.	Use fully skimmed or semi-skimmed milk at refrigerator temperature (about 5° C). If the result is not as you wished, try changing brand of milk.
	The froth adjustment dial (D1) is incorrectly adjusted.	Adjust following the instructions in section "Adjusting the amount of froth".
	The milk container lid (D2) or froth adjustment dial (D1) is dirty	Clean the milk container lid and froth adjustment dial as described in par. "Cleaning the milk container".
	The hot water/steam connection nozzle (A13) is dirty	Clean the connection nozzle as described in par. "Cleaning the hot water/steam connection nozzle".
The machine emits noises or small puffs of steam while not in use	The machine is ready for use, or has recently been turned off, and condensate is dripping into the vaporiser which is still hot	This is part of normal operation. To limit this, empty the drip tray.

ESPRESSO

Origin	Italy		
PROCESS	<i>Grinding</i> <i>Brewing</i>	Coffee powder Pre-infusion Infusion	6-11gr (according to aroma) • high pressure (9-12 bar)
RESULT IN CUP	Default Quantity Cream Taste		~ 40ml compact and nut-coloured intense
OCCASION OF USE	short-term pleasure, every moment of the day		

COFFEE

Origin	Germany & Central Europe		
PROCESS	<i>Grinding</i> <i>Brewing</i>	Coffee powder Pre-infusion Infusion	8-14gr (according to aroma) no pre infusion high pressure (9-12 bar)
RESULT IN CUP	Default Quantity Cream Taste		~ 180ml thinner than espresso balanced and delicate
OCCASION OF USE	long-lasting pleasure, every moment of the day		

LONG

Origin	USA, Australia		
PROCESS	<i>Grinding</i> <i>Brewing</i>	Coffee powder Pre-infusion Infusion	2 grindings of 5-9gr (according to aroma) no pre infusion impulse mode lower pressure than espresso
RESULT IN CUP	Default Quantity Cream Taste		~ 160ml thinner and lighter than espresso perfect for drip coffee lovers
OCCASION OF USE	long-lasting pleasure, every moment of the day		

DOPPIO+

Origin	Italy		
PROCESS	<i>Grinding</i> <i>Brewing</i>	Coffee powder Pre-infusion Infusion	15gr reduced pre infusion higher pressure than espresso
RESULT IN CUP	Default Quantity Cream Taste		~ 120ml thicker and darker than espresso stronger than espresso
OCCASION OF USE	need for energy		

AMERICANO

Origin	USA, UK		
PROCESS	<i>Grinding</i> <i>Brewing</i>	Coffee powder Pre-infusion Infusion	6-11gr (according to aroma) • high pressure (9-12 bar)
RESULT IN CUP	Default Quantity Cream Taste		~ 150ml thinner and lighter than espresso Light and delicate

ESPRESSO MACCHIATO

Origin	Italy		
PROCESS	Coffee Milk Milk foam Delivery order		6-11gr (according to aroma) (~ 30ml) few drops (~ 20ml) maximum level coffee first, milk afterwards
RESULT IN CUP	Visual Milk foam		black with one thin layer or milk foam
OCCASION OF USE	every moment of the day, people who want to taste a slightly sweet espresso		

CAPPUCCINO

Origin	Italy	
PROCESS	Coffee	balanced (~ 80ml)
	Milk	balanced (~ 70ml)
	Milk foam	maximum level
	Delivery order	milk first, coffee afterwards
RESULT IN CUP	Visual	separate layers of foam, coffee and milk
	Milk foam	white with milky taste
OCCASION OF USE	every moment of the day, people who want to taste coffee and milk separately	

CAPPUCCINO+

Origin	Italy	
PROCESS	Coffee	Doppio+ (~ 120ml)
	Milk	~ 70ml
	Milk foam	maximum level
	Delivery order	milk first, coffee afterwards
RESULT IN CUP	Visual	darker than cappuccino
	Milk foam	separate layers of foam, coffee and milk, with milky taste
OCCASION OF USE	need for energy, people who want a cappuccino with a strong coffee taste	

CAPPUCCINOMIX

Origin	Italy	
PROCESS	Coffee	balanced (~ 80ml)
	Milk	balanced (~ 70ml)
	Milk foam	maximum level
	Delivery order	coffee first, milk afterwards
RESULT IN CUP	Visual	uniformly brown milk drink
	Milk foam	light brown with coffee taste
OCCASION OF USE	every moment of the day, people who loves melted milk and coffee tastes	

LATTE MACCHIATO

Origin	Italy	
PROCESS	Coffee	~ 60ml
	Milk	~ 90ml
	Milk foam	medium level
	Delivery order	milk first, coffee afterwards
RESULT IN CUP	Visual	separate layers of foam, coffee and milk
	Milk foam	white with milky taste
OCCASION OF USE	every moment of the day, people who want to taste coffee and milk separately	

FLAT WHITE

Origin	USA, Australia	
PROCESS	Coffee	~ 60ml
	Milk	~ 200ml
	Milk foam	medium level
	Delivery order	milk first, coffee afterwards
RESULT IN CUP	Visual	separate layers of foam, coffee and milk
	Milk foam	served in a ceramic cup white with milky taste
OCCASION OF USE	every moment of the day, people who want to taste coffee and milk separately	

CAFFELATTE

Origin	Italy	
PROCESS	Coffee	~ 60ml
	Milk	~ 240ml
	Milk foam	medium level
	Delivery order	milk first, coffee afterwards
RESULT IN CUP	Visual	separate layers coffee and milk
	Milk foam	little layer of white foam with milky taste
OCCASION OF USE	every moment of the day, people who want to taste coffee and milk separately	

The manufacturer reserves the right to make any changes deemed useful for improvement of its products without prior notice. The illustrations and descriptions contained in this manual are therefore not binding and are merely indicative.

SMEG S.p.A.

Via Leonardo Da Vinci, 4
42016 San Girolamo di
Guastalla (RE)
ITALY

www.smeg.com

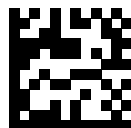

5713244661_03_1224