

Refrigerator-Freezers

SERIES MODEL

**MR-508EK, MR-508EKL,
MR-560EK, MR-560EKL**

OPERATING INSTRUCTIONS



R600a

Non-Freon Refrigerators

This refrigerator uses non-Freon refrigerant (isobutane) and non-Freon foam insulation (cyclopentane). These materials are harmless to the environment and do not affect the ozone layer and global warming.

- Please read this manual carefully and follow the information contained within. In particular, be sure to read the safety precautions before using this refrigerator.
- Be sure to receive your copy of the warranty from the retailer and confirm that the purchase date and retailer name are written on the warranty.
- Store this operating instructions manual and the warranty in a safe place.
- This refrigerator was manufactured for refrigerating and freezing of foods in general households. For commercial use, please use a commercial refrigerator-freezer.
- The principal plastic components indicate the material name to facilitate recycling.

Cleaning Instruction - Important!

It is strongly recommended to use only lukewarm water and a soft cloth when cleaning. Cleaning agents can cause cracking to the plastic components of your refrigerator.

Safety Precautions

■ The types of danger that can result from improper handling are explained in the sections below.

Warning

Mishandling can lead to serious injury or death.

Caution

Mishandling can lead to bodily injury or loss of home and household contents.

■ The symbols illustrated below have the following meanings.

	Do not do
	Do not touch
	Do not take apart, repair or convert
	Do not get wet
	Do not touch with wet hands
	Always follow instructions
	Always connect an earth wire
	Always unplug electrical plug from socket

■ When something abnormal or unusual occurs, turn off immediately and consult with “the store where you purchased the unit” or with a “Mitsubishi Electric repair counter.”

Warning

When installing your unit

Allow some space around the refrigerator.

If the refrigerant (gas) leaks, it can remain in the area and there's a risk that it may cause a fire or explosion.

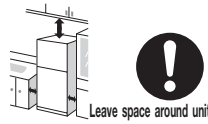

Do not install in an outdoor area where water can get on it or where there is a lot of moisture. Due to insulation failure, it may cause an electric shock or fire.



Page 5

Use a dedicated outlet for the power supply that meets the rating specified on the rating label. (The rating label is located on the door-liner of the refrigerator compartment.)

Using an extension cord or plugging in too many power cords into the outlet can cause heat buildup or a fire.

Page 5



If the power cord is damaged.

If the power cord is damaged call Mitsubishi Electric Service Centre for a technician to replace power cord. The power cord should be designed for this model.

Page 5



Keep the electrical plug cord facing downwards and insert the plug in fully.

If it is plugged with the cord facing upward, extra pressure gets exerted on it which can cause it to heat up or ignite.



Plug with cord downward

About the electrical outlet and electrical plug

When replacing the interior refrigerator light or when taking care of the unit, pull out the electrical plug.

Not doing so can result in an electric shock or injury.



Pull out the plug

Do not push the electrical plug with the back of the refrigerator. Do not damage the electrical cord.

If the plug is pressed by the refrigerator, or if the cord is bent, bundled, or a heavy object is placed on it, it can cause an electric shock or a fire.



Do not do

Do not use damaged cords or plugs or loose outlets.

Using them can result in an electric shock or injury.



Do not use

Do not remove the electrical plug by pulling the cord.

The cord can become damaged and can cause an electric shock or a fire.



Do not do

Remove dust from the electrical plug.

Not doing so can cause a fire from insulation failure.



Remove dust

Do not plug or unplug the electrical plug with wet hands.

It can cause an electric shock.



Do not use wet hands

Caution

Installing and Transporting

Install on a strong level floor and adjust the adjustable legs to fix firmly.

The refrigerator may move and cause injury.

Page 5

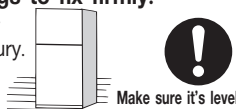

Make sure it's level

When carrying, use the handles made for carrying.

If other parts are held while carrying, it can cause injury.

Page 10



Use carrying handles

About Using

Do not force food items into the refrigerator. Do not use force to pull out shelves.

Food items may fall out, causing injury.



Do not do

Do not touch foods or containers in the freezer compartment with wet hands.























Doing so can cause freezer burn.













Do not use wet hands

! Warning

About using your refrigerator







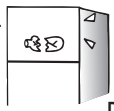

<p>Do not put any vessels, jars, etc. that contain water on top of the refrigerator.</p> <p>If water gets onto electrical parts, it will cause an electric shock or a fire.</p>   <p style="text-align: right;">Do not get wet</p>	<p>Do not use electrical products inside the refrigerator unit.</p> <p>If the refrigerant (gas) is leaking inside the unit, there is a risk that a spark from the electrical product's contact can be a source for ignition or explosion.</p>   <p style="text-align: right;">Do not do</p>	<p>Do not store volatile products that can easily ignite.</p> <p>Benzene, cosmetics and hair styling products can be the cause for igniting fires and explosion.</p>   <p style="text-align: right;">Do not store</p>			
<p>Do not place items on top of the refrigerator.</p> <p>Items may drop from opening and closing the door and can cause injury.</p>   <p style="text-align: right;">Do not do</p>	<p>Do not store pharmaceuticals or scientific test material.</p> <p>Anything that needs strict supervision must not be stored in a home-use refrigerator.</p>   <p style="text-align: right;">Do not store</p>	<p>Do not hang on the door or door handle, and do not get on compartment drawer-type doors.</p> <p>The refrigerator can topple over causing injury.</p>   <p style="text-align: right;">Do not do</p>			
<p>When opening and closing the door, be careful not to let it hit any surrounding furniture.</p> <p>There is a risk of injury and the door or furniture is damaged.</p>  <p style="text-align: right;">Prohibited</p>	<p>Do not damage the refrigerant circuit (piping) of the refrigerator; do not drive in screws.</p> <p>Because a flammable refrigerant (gas) is used, there is the danger of igniting or explosion.</p>   <p style="text-align: right;">Do not do</p>	<p>If you sense a gas leakage, do not touch the refrigerator. Open the window and ventilate the room.</p> <p>A spark from the electrical contact can cause an explosion or a fire.</p>   <p style="text-align: right;">Ventilate the room</p>			
<p>Do not wash with water or spill liquid food items on the unit.</p> <p>If water and food liquids get on the unit, it can cause an electric shock or a fire. If that happens, dry off immediately.</p>   <p style="text-align: right;">Do not get wet</p>	<p>Do not use flammable sprays nearby.</p> <p>A spark from the electrical contact can ignite and cause a fire.</p>   <p style="text-align: right;">Do not use</p>	<p>Do not use in a shed or a garage.</p> <p>If small animals damage the wiring, it can cause an electric shock or a fire.</p>  <p style="text-align: right;">Do not use</p>			
<ul style="list-style-type: none"> ● WARNING - Do not use mechanical devices or other means to accelerate the defrosting process, other than those recommended by the manufacturer. ● WARNING - Do not use electrical appliances inside the food storage compartments of the appliance, unless they are of the type recommended by the manufacturer. 			<ul style="list-style-type: none"> ● This appliance is not intended for use by young children or infirm persons unless they have been adequately supervised by a responsible person to ensure that they can use the appliance safely. ● Young children should be supervised to ensure that they do not play with the appliance. ● This appliance is not intended for use by persons (including children) with reduced physical, sensory or mental capabilities, or lack of experience and knowledge, unless they have been given supervision or instruction concerning use of the appliance by a person responsible for their safety. Children should be supervised to ensure that they do not play with the appliance. 		

About Malfunctions / Long Term Care

<p>If the refrigerant circuit (piping) is damaged, do not touch the refrigerator, open the window and ventilate the room.</p> <p>When the refrigerant circuit is damaged, please consult the store in which the unit was purchased.</p>   <p style="text-align: right;">Ventilate the room</p>	<p>If something abnormal occurs (such as a burning smell), pull out the electrical plug and stop the refrigerator from running.</p> <p>If it continues to run in an abnormal state, it can cause an electrical shock or a fire.</p>   <p style="text-align: right;">Pull out the plug</p>	<p>Do not take apart, repair or convert. Do not continue to use with damaged parts.</p> <p>This can cause injury, an electric shock or a fire.</p>   <p style="text-align: right;">Do not take apart</p>
<p>If there is a possible danger of a child getting trapped inside while the refrigerator is not in use, please pull off the door seal.</p> <p>It is dangerous if the child gets shut inside.</p>   <p style="text-align: right;">Remove the door seal</p>	<p>If you will not be using the refrigerator for a long period of time, after pulling out the electrical plug, open the door and let the interior dry out.</p> <p>If it is not dried adequately, the cooling unit may corrode causing the refrigerant (gas) to leak which can then cause the danger of ignition or explosion.</p>  <p style="text-align: right;">Dry properly</p>	<p>When disposing of the unit, transfer it to the store that you purchased it or to the municipality.</p> <p>If it is neglected and refrigerant (gas) leaks, ignition or an explosion may be caused due to heat from a fire.</p>  <p style="text-align: right;">Transfer it over</p>

! Caution

About Using Your Unit

<p>Do not store bottles in the freezer compartment.</p> <p>If the center freezes and bottles crack, it will cause injury.</p>   <p style="text-align: right;">Do not store</p>	<p>Do not eat foods that have a bad smell or are discolored.</p> <p>Doing so may cause food poisoning or other illnesses.</p>   <p style="text-align: right;">Do not do</p>	<p>When opening and closing the door.</p> <ul style="list-style-type: none"> ● Do not open or close the door while someone else is in the way. ● Do not place your fingers at the top of drawer-type doors when closing the door. ● Do not close the lower drawers with your foot (as it may get caught). ● Do not open or close the door forcefully (food items may fall and cause injuries)  <p style="text-align: right;">Do not do</p>
<p>Do not place your hands or feet under the refrigerator.</p> <p>You can get injured from something such as the steel plate.</p>   <p style="text-align: right;">Do not touch</p>	<p>Close the door by holding the handle.</p> <p>Hold it in a way so that you don't get your fingers caught in the door. Not doing this may cause injury.</p>  <p style="text-align: right;">Hold the handle</p>	

1. Components

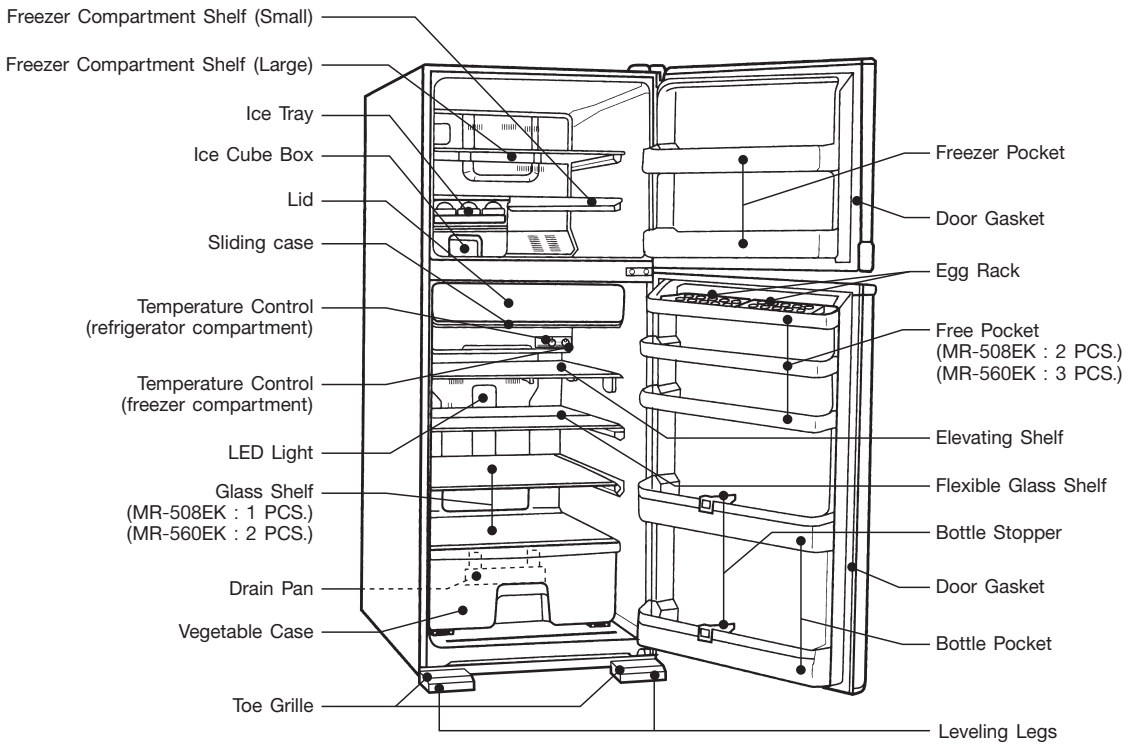

This illustration shows series models MR-508EK, MR-560EK

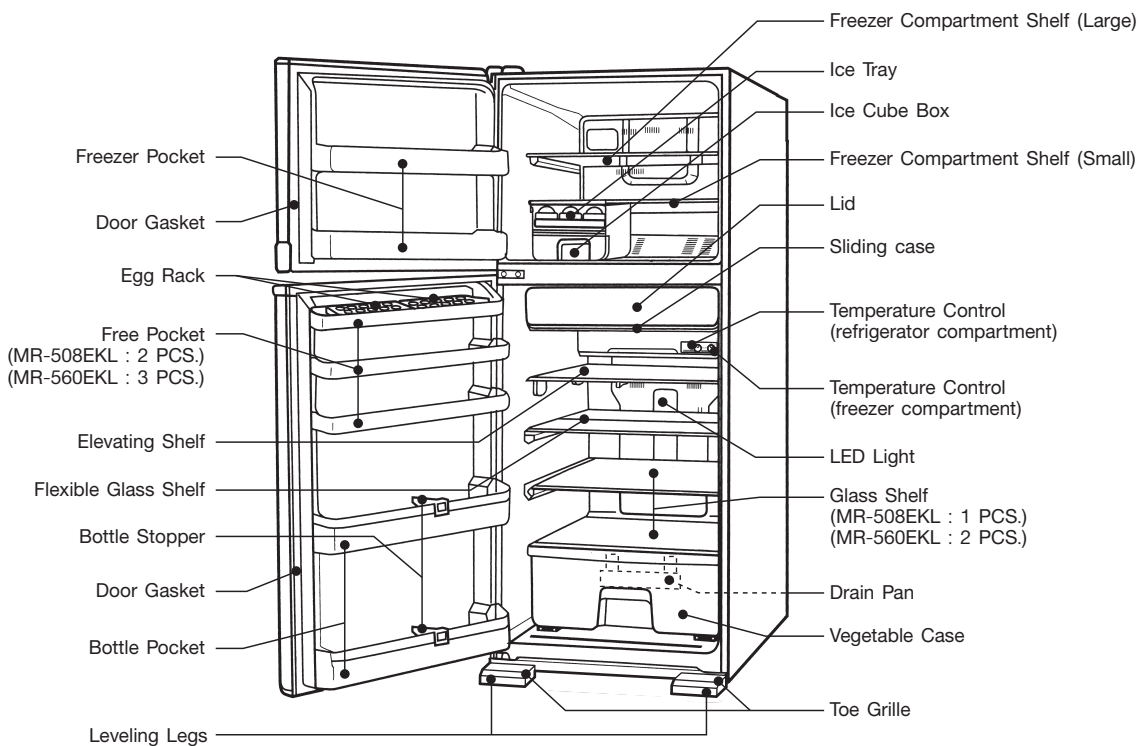

This illustration shows series models MR-508EKL, MR-560EKL

2. Installation

- Install on a completely flat and rigid surface.
- Using the two front adjustable feet, ensure that the refrigerator is positioned firmly and level on the floor. Now open the doors approximately half way, and extend the front adjustable feet equally until the doors close by themselves.
- To ensure adequate ventilation for your refrigerator, spaces of 20mm on both sides, 50mm at the rear, and 100mm above the refrigerator are recommended. Insufficient spacing will decrease cooling efficiency, resulting in unnecessary energy consumption.
- Choose a location which is not exposed to sunlight, is relatively free from dust, heat and humidity, and offers good ventilation in order to guarantee that heat radiation will not be impaired.

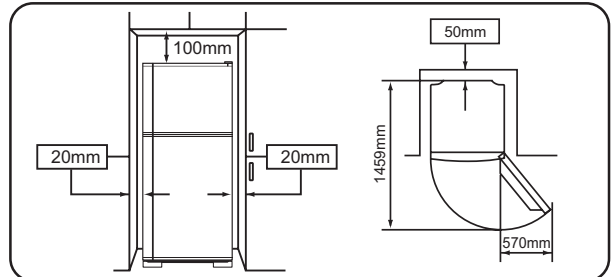
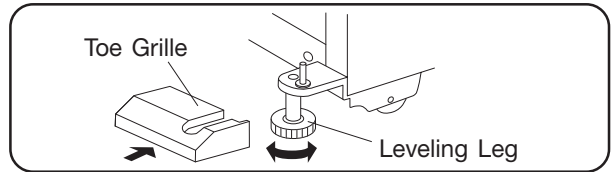

Use in hot spring areas

Corrosion control treatment may be required for the refrigerant circuit (pipe) due to generation of corrosive gases. Contact the retail store where you purchased the refrigerator.

⚠ Warning

Do not obstruct the refrigerator vents or the space around the refrigerator. If refrigerant leaks, it may accumulate and catch fire or explode.

How to remove the energy label

- Remove the energy label carefully. A glue residue may remain, particularly if the label has been in place for a long period of time.
- Apply either Eucalyptus or Tea Tree oil directly on any residue.
- Do not allow the oil to run or drip onto plastic parts as it may cause the plastic to degrade and potentially crack over time.
- Allow the oil to sit for approximately 1-2 minutes, or until the glue residue has softened.
- Wipe off with a damp cloth.
- If any residue remains, repeat the above process.
- Rinse with clear water.
- Dry thoroughly.

During Transport

- Before transporting, wipe dry the evaporating pan, which is located at the rear. Carry the refrigerator holding the handles located at the rear and bottom.

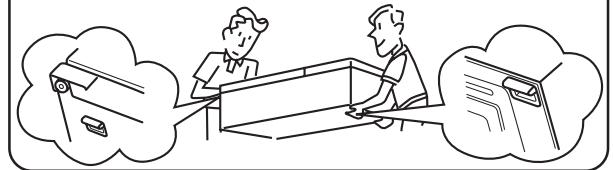

Do not damage the refrigerant circuit (pipes) or drive screws into it.

Although R600a refrigerants are combustible, the refrigerant circuit is hermetically sealed and normally leaks will not occur.

⚠ Warning

Should the refrigerant circuit be damaged:

1. Do not use flames or electrical appliances nearby.
2. Open the windows to fully ventilate the room.

Then, contact the retail store where you purchased the refrigerator.

3. Electrical Connections

Important: For personal safety, this appliance must be properly grounded.

- The refrigerator should always be plugged into its own individual electrical outlet. This is recommended for best performance and also in order to prevent the overloading of household wiring circuits, which may cause a fire hazard. Extension cords are not recommended. Make sure that the outlet provides the correct voltage.
- If your refrigerator has a grounding plug, use it correctly. The 3-point plug must be inserted into a mating 3-point grounded receptacle. If the installation location does not have a proper 3-point grounding wall receptacle, the proper type must be installed. The ground point should never be cut or removed.
- If your refrigerator has an ungrounding plug, connect the ground wire to the ground connection screw provided at the lower rear side of the refrigerator.

4. Operation

1. Temperature Control

- Both the freezer compartment and the refrigerator compartment have a temperature control.
- “MID” is recommended for normal usage. Turn the dial to “COLDER” when storing a large quantity of frozen foods, ice cream etc., in the freezer compartment. Turn the dial to “FREEZER” when only using the freezer compartment to make ice.
- “MID” is recommended for normal usage. If you would like items in the refrigerator compartment to be colder, turn the dial to “COLDER”. If the items are too cold or freeze in the refrigerator compartment, turn the dial to “REFRIGERATOR”.

Temperature Control of the Freezer Compartment

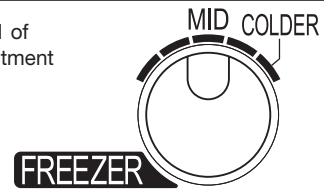

Temperature Control of the Refrigerator Compartment

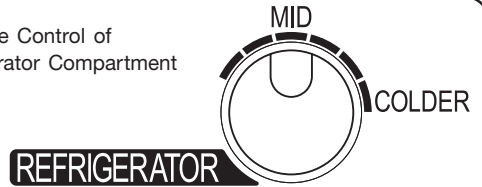

2. Automatic Defrosting

The defrosting heater provides automatic defrosting in the refrigerator according to the accumulated time calculated by the microcomputer, so there is no need to defrost it manually. Water produced during defrosting passes through the drainage hose at the rear and collects in the drain pan in the lower rear part of the refrigerator. Then, it automatically evaporates with heat from the refrigerant pipe, which is utilized as a radiator.

3. Ice-making

- Pour water up to the water line in each of the ice tray sections. Insert the tray completely into the ice tray holder. If too much water is added, the ice cubes cannot be easily separated from the ice tray.
- Once the ice cubes have been made, turn the lever until they fall into the ice cube storage box.
- If you attempt to make ice directly in the ice cube storage box, the box will break.

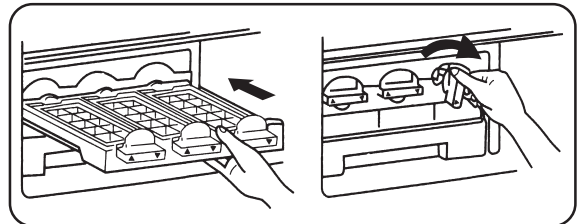

4. Sliding Case

- This sliding case is cooled to a low temperature in order to preserve the freshness of foods stored for long periods.

CAUTION:
Before closing the refrigerator compartment door, make sure that the sliding case is pushed all the way in (and the lid is closed correctly).

Open by pulling the case out.

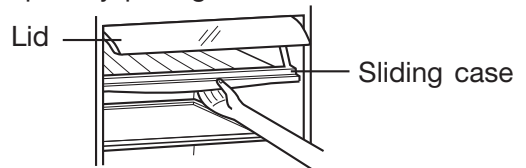

- Remove the lid and sliding case as shown in the illustration and proceed with cleaning.
- Pull the case out. Open the lid and then pull out holding the right and left hand sides (Fig. 1).
- Pull the case out all the way. Pull out by holding and lifting the edge of the case upwards (Fig. 2).

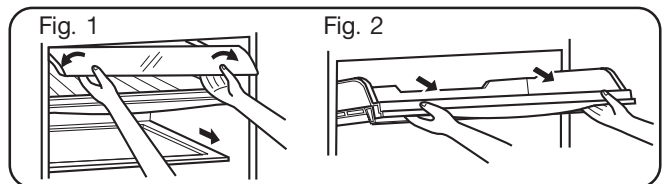

5. Door Racks

The door racks may be used to store all those little items that seem to get in the way. If you put all the small items in one place, you'll find that there's more space inside the refrigerator for larger items.

Free Pocket with Egg Tray

- Many eggs may be stored in the free pocket (Fig. 1).
- If you turn half the egg tray over, small items may be stored together with the eggs (Fig. 2).
- You can even turn the whole egg tray over and store small items in the free pocket instead of eggs (Fig. 3).

Fig. 1

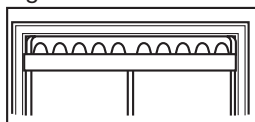

Fig. 2

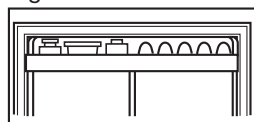
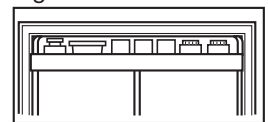
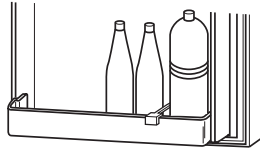

Fig. 3



Bottle Pocket

- Even large bottles may be stored in this pocket.



Some types of commercial water cooler bottles may touch the shelf or foodstuffs when placed in the door pocket, preventing the door from closing firmly.

6. How to Remove the Pockets

- Remove the door racks as shown in the illustration in order to proceed with cleaning.
- This pocket may be removed by pushing it gently upwards.

Freezer Pocket



Free Pocket



Bottle Pocket



7. Flexible glass shelf

- To storage large or tall item

① Remove all food items from the Flexible shelf.

② Press down the Rear Shelf then pull the Front Shelf out, which the Front Shelf can be separated from the Rear Shelf.
(If you have a difficulty for pulling the Front Shelf out, please press on the edge of the Rear Shelf and pull the edge of the Front Shelf out, then the Front Shelf can be easily to pull out.)

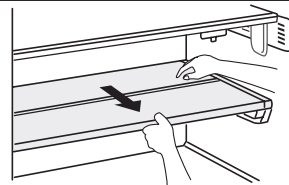

③ Put the Front shelf on the top of Rear Shelf.
(Caution : The Front Shelf shall be under the rail of the Food Liner.)

④ Push the Front Shelf back to the rear, this creates more space for food storage.

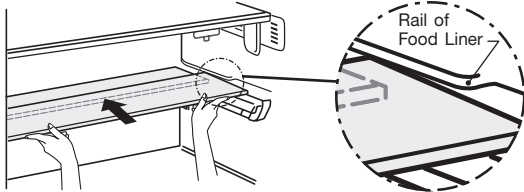

- To storage small item

① Remove all food items from the Flexible shelf.

② Raising the front shelf slightly, then pull out forward.

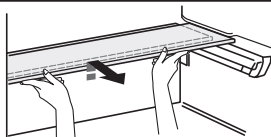

③ Push the Front Shelf back in order to take the assembly with the Rear Shelf.

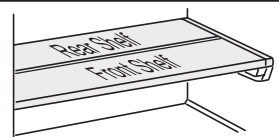

CAUTION

CAUTION : If you take out Flexible shelf, please don't hold vertically that make a tier drop off and cause the injury.

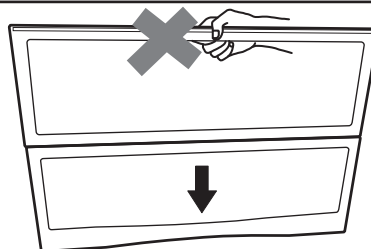

8. Elevating shelf

- Move the lever on the front of the shelf left or right to adjust the shelf to the desired position.

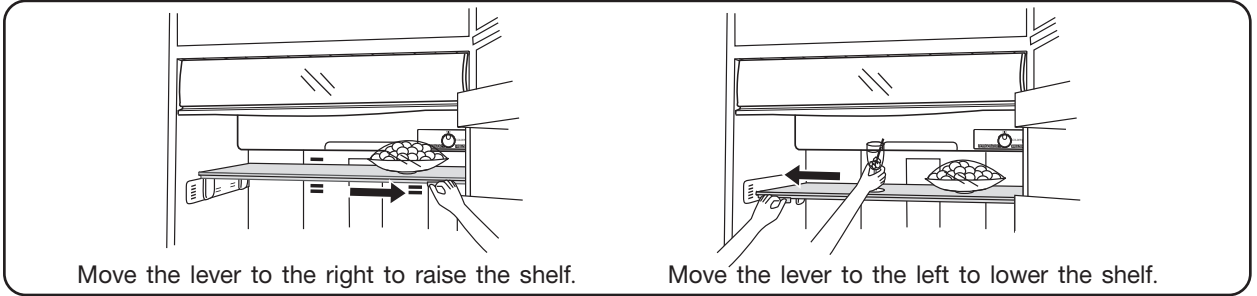

- The lever will be difficult to move when heavy items are placed on the shelf.
- When the elevating shelf is lowered, one of the shelf supports may come off if the shelf contacts any foods under the shelf. This is to prevent damaging the foods. If one of the supports comes off, push it back into position from above.

Installation

- ① Make sure that the lever is moved completely to the right.



- ② Make sure that the 4 metal stoppers are securely fitted into the refrigerator, then lightly set the shelf into the refrigerator and align the 4 supports with the 4 stoppers.

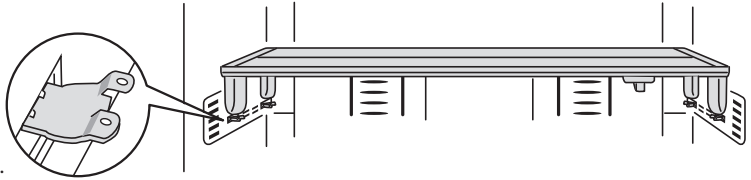

- ③ Push each of the 4 supports, one at a time, downward from above. (When the internal hooks catch onto the refrigerator, a “click” sound will be heard.)

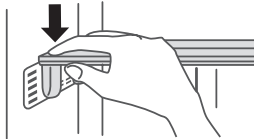

- ④ Finally, move the lever to the left and right and check that the shelf moves up and down while remaining level. (If the shelf does not remain level, the 4 hooks are not securely caught onto the refrigerator. Remove the shelf and repeat steps 1 to 4.)

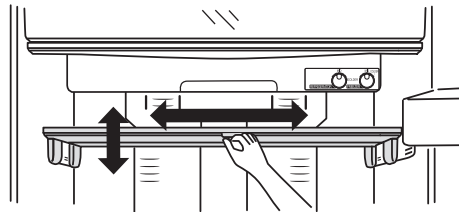

5. Maintenance

When performing maintenance, make absolutely sure that the power plug is first disconnected from the power outlet.

- Dip a soft cloth into cold or lukewarm water, wring it out well and wipe.
- If you do not clean the door gasket (especially the lower part) when it is dirty, the gasket will easily become damaged. Therefore, keep it clean at all times.
- Do not clean with cleanser, acids, benzene, thinner, boiling water, soap powder, chemical cloths or neutral detergent. These will damage the paint finish and external surfaces of your refrigerator.

CAUTION

Do not apply water directly onto the refrigerator.
This may result in malfunction, power leakage or fire.

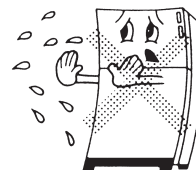

- The drain pan becomes dirty very easily and if not cleaned regularly, produces bad odours. Get into the habit of cleaning this pan regularly.

How to Replace the LED Light

- In the event that the LED light is damaged or malfunctions, please refrain from adjusting or repairing it by yourself. Please contact the service center instead.

● How to remove the elevating shelf

- ① Move the lever completely to the right.

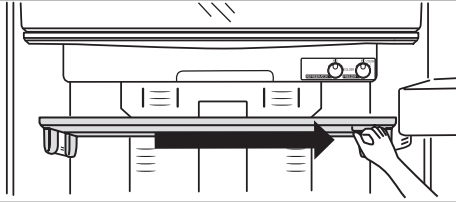

- ② Push up each support, one at a time, with a strong effort. (4 supports) (When the internal hooks are released from the refrigerator, a “click” sound will be heard.)

If the supports are not released easily, push the internal hooks inward.

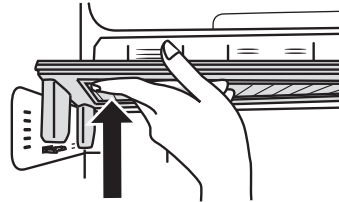
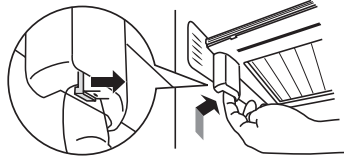

- ③ After the 4 supports are released, pull out the shelf.

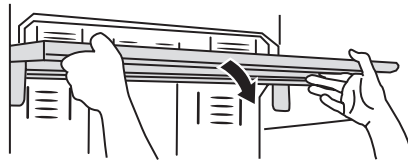

● How to remove the tray

- ① Push the tray upward while pulling forward the hooks (3) at the back of the shelf with your finger.

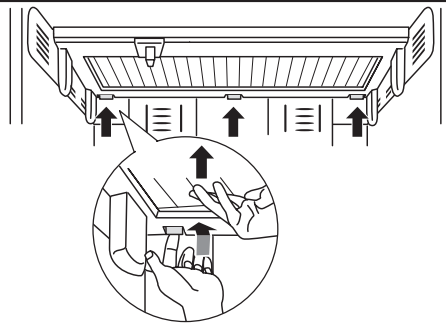

- ② Lift up the back of the tray until the front hooks (4) are released.

* Lift up the tray slowly, otherwise it may fall.

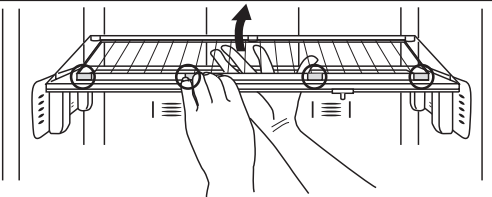

- ③ Remove the tray with both hands.

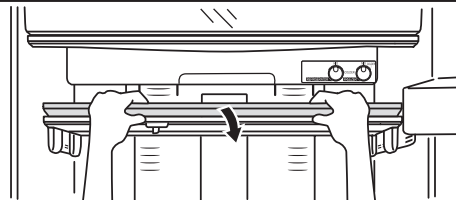

- Disassembling or applying grease to the elevating shelf can cause it to malfunction.

6. What to do in these situations

When there's a power failure.

- Minimize opening/closing of doors and avoid putting in more food.

When not in use for a long time.

- Clean the Ice cube box and Ice tray, clean the interior after unplugging the refrigerator, and keep the door open for 2 - 3 days to let it get dry.
 - ※ If not allowed to dry properly, mold and odors can occur, or refrigerant (gas) may leak due to corrosion of the cooling unit.

When transporting.

1. Discard the water/ice from the Ice cube box and the Ice tray. **Page 4**
2. Use protective gear (protective gloves).
3. Lay towels under the water discharge outlet and under the back corners of the refrigerator, and place a container or tray on the floor that's about 3 cms high to catch water.
 - ※ Towels prevent water from spilling on the floor and damage to the floor.
4. Slowly tilt the refrigerator back to an angle of over 30 degrees, discharge water of the evaporator tray through the water discharge outlet (the evaporator tray is not visible from the outside.)
 - ※ Have 2 or more persons do this work because the unit is heavy.
 - ※ Avoid having young children or those without confidence do this work. Please seek advice from a moving company.
5. With more than 2 persons, calmly and slowly transport the unit by grasping the front side's lower section inner edge and the back side's upper section handle.
 - Do not lay or load on its side (it will cause damage to the compressor.)

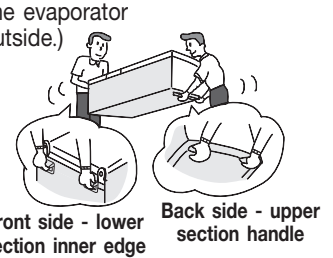
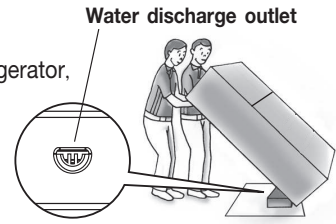

When moving the unit / when changing the direction of the unit.

1. Lift the adjustable legs. **Page 5**
2. Move in a forward or backward direction. ● If moved other than a in forward or backward direction, there's a risk of damaging the floor.
3. When changing the direction of the unit, please use caster wheels or place a protective cloth under the back legs.

Warning

Do not damage the refrigerant circuit, do not drive in screws, etc.

The unit uses a flammable refrigerant, so if the gas leaks out, there is the risk of ignition or an explosion.

7. Troubleshooting

When the refrigerator fails to operate

- Check for a power failure.
- Check if the power cord is plugged into the power outlet.
- Check that the fuse (or circuit-breaker) has not blown.

When the refrigerator is cooling excessively

- The temperature control dial may be set too high.
- If you place foodstuffs containing a lot of moisture directly under the cool air outlets, they will freeze easily. This does not indicate a malfunction.

When you hear a sound similar to flowing water

- The sound of flowing water is the flow of refrigerant (cooling gas). This does not indicate a malfunction.

When noise is produced by the fan grill of the refrigerator

- The noise produced by the fan grill will stop at a certain fixed temperature. The airflow cooling system inside the refrigerator is powered by the operation of the fan motor and fan grill.

When noise is produced while the refrigerator door is open

- When you open a door panel, plastic components switch swiftly between hot and cold, and this may produce noise. When the door is closed, the noise will remain until the difference in temperature is reduced.

When the refrigerator is not cooling sufficiently

- The food may be packed too tightly together, which blocks the flow of cool air.
- You may have put hot or too many items into the refrigerator.
- The door may not have been closed properly.
- The door gasket may be damaged.
- The refrigerator may not be well-ventilated.
- There may be insufficient clearance between the refrigerator and the surfaces immediately beside and above.
- The temperature control dial may not be properly set.

When the front of the refrigerator cabinet heats up

- In order to safeguard against condensation, there is an anti-condensation pipe which heats up the front of the cabinet when actuated. When the front of the cabinet is warm, this does not indicate a malfunction. The more often the door is opened and closed, the more often the anti-condensation pipe is actuated. It is also actuated immediately after the refrigerator has been installed. In other words, the front of the cabinet often heats up.

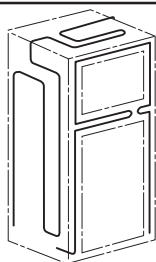

When condensation forms on the exterior of the refrigerator

- Condensation may form on the exterior when humidity is high, such as during the wet season. This is comparable to condensation forming on the outside of a glass when chilled water is poured in; therefore, it does not indicate a failure. Wipe dry with a dry cloth.

When the power plug is disconnected and reconnected, and the compressor ceases to rotate

- When the power plug is disconnected from the power outlet and then immediately plugged in again, the compressor may not restart. Therefore, when unplugging the refrigerator, always wait at least 5 minutes before plugging it in again. If the compressor ceases to rotate completely, keep the refrigerator unplugged and wait at least 5 minutes before plugging it in again.

When the side panel of the cabinet heats up

- The side panel of the cabinet will heat up when the door is opened and closed frequently, when installing the unit and when the unit operates in summer in high temperatures. In such cases, do not touch the panel. This heat buildup is due to the dissipation of heat absorbed from inside the cabinet over the whole of the side panel and does not indicate something wrong with the unit.

CAUTION

1. This appliance is designed for use in ambient temperature listed below.

MODEL NAME	AMBIENT TEMPERATURE RANGE	CLIMATIC CLASS
MR-508EK/EKL, 560EK/EKL-A	16 °C ~ 43 °C	T
MR-508EK/EKL, 560EK/EKL-NZ	16 °C ~ 43 °C	T

The internal temperatures could be affected by such factors as the location of the refrigerating appliance, ambient temperature and the frequency of door opening, and, if appropriate, a warning that the setting of any temperature control device might have to be varied to allow for these factors.

2. A rise in temperature of the frozen food during manual defrosting, maintenance or cleaning could shorten the storage life.
3. Food to be frozen is not to be placed in direct contact with food in storage and, if appropriate, that it could be necessary to reduce the quantity to be frozen if freezing every day is anticipated.
4. The electrical power failure for 1-2 hour will only slightly effect the inside temperature. However, open & close of the door results in the temperature loss. In case there is more than 24 hours electrical power failure, the food should be taken out from the fridge.
5. In case you are leaving or there is no food in the fridge for more than 3 weeks, The fridge should be unplugged and cleaned.

- The appliance is not intended for use by young children or infirm persons without supervision.
- Young children should be supervised to ensure that they do not play with the appliance.
- **WARNING** - Do not use mechanical devices or other means to accelerate the defrosting process, other than those recommended by the manufacturer.
- **WARNING** - Do not use electrical appliances inside the food storage compartments of the appliance, unless they are of the type recommended by the manufacturer.
- **WARNING** - Just in case of having damaged the refrigerant circuit, do not use electric items or fire equipments near by, and open the window to ventilate the room. And contact the retail store at which you purchased it or the following MITSUBISHI SERVICE CENTER.
- **WARNING** - When positioning the appliance, ensure the supply cord is not trapped or damaged.
- **WARNING** - Do not locate multiple portable socket-outlets or portable power supplies at the rear of the appliance.
- The refrigerator contains flammable refrigerant (R600a: iso-butane).
- The refrigeration system behind and inside the refrigerator contains refrigerant. Do not allow any sharp objects to come into contact with the refrigeration system.
- Do not block the openings on the circumstances of the refrigerator.
- The user manual should be handed over to any person who would use or handle the refrigerator whenever the refrigerator would be transferred to another location and delivered to a recycling plant.
- This refrigerator uses flammable foaming gas for insulation. Please deliver the unit to specialized industrial waste dealer when you do away it. Please follow the rules in your country.
- Do not store explosive substances such as aerosol cans with a flammable propellant in this appliance.
- This appliance is intended to be used in household application only.

R600a Refrigerant Warning

- This appliance contains a small quantity of R600a refrigerant which is flammable.
- During transportation and installation, ensure that the tubing of the refrigerant circuit is not damaged.
- Leaking refrigerant can ignite and may damage the eyes.
- In the event any damage does occur, avoid exposure to open fires and any device which creates a spark. Disconnect the appliance from the mains power.
- Thoroughly ventilate the room in which the appliance is located for several minutes.
- Notify Mitsubishi Electric Australia Pty Ltd. for necessary action and advice.
- The room for installing the appliance must be at least 1 cubic metre per 8 grams of refrigerant. The refrigerant quantity contained in this appliance is noted on the Rating Label of the appliance.
- If your Mitsubishi Electric Refrigerator should require service, please contact Mitsubishi Electric Australia Pty Ltd see back page of this user manual for contact details.

NOTE: MITSUBISHI ELECTRIC AUSTRALIA PTY LTD. DO NOT ALLOW SERVICE TO THE REFRIGERATION CIRCUIT OF THIS APPLIANCE.



If an abnormality or malfunction occurs, stop operation immediately and contact the retail store where you purchased the refrigerator or MITSUBISHI ELECTRIC SERVICE CENTRE or its service agent.

**SOLE AGENT in Australia
MITSUBISHI ELECTRIC AUSTRALIA PTY LTD.**

(Incorporated in New South Wales) ABN 58 001 215 792
348 Victoria Road, Rydalmere NSW 2116

For more information and support contact

www.mitsubishielectric.com.au
Call 1300 651 808

**SOLE AGENT in New Zealand
BLACK DIAMOND TECHNOLOGIES LIMITED (BDT)**

Wellington Office (Head Office)

1 Parliament Street Lower Hutt PO Box 30772 Phone: (04) 560 9147, Fax: (04) 560 9133

Auckland Office

Unit 1, 4 Walls Road Penrose PO Box 12726 Phone: (09) 526 9347, Fax: (09) 526 9348

Christchurch Office

44 Halwyn Drive Hornby PO Box 16904 Phone: (03) 341 2837, Fax: (03) 341 2838

MITSUBISHI ELECTRIC CORPORATION

NZ79C662H02