



OneOdio

# OneOdio

---

Studio Pro 10

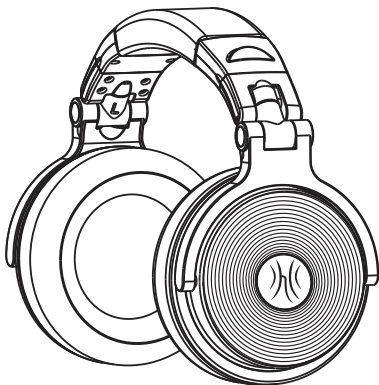

**User Manual**

## IMPORTANT SAFETY INSTRUCTIONS

Please read and keep all safety and use instructions.

### WARNINGS/CAUTIONS

- Do NOT use the headphones at a high volume for any extended period.
  - To avoid hearing damage, use your headphones at a comfortable, moderate volume level.
  - Turn the volume down on your device before placing the headphones in/on your ears, then turn the volume up gradually until you reach a comfortable listening level.
- Do NOT use your headphones while driving for phone calls or any other purpose.
- Do NOT use the headphones at any time the inability to hear surrounding sounds may present a danger to yourself or others, e.g., while riding a bicycle or walking in or near traffic, a construction site or railroad, etc.
  - Remove the headphones, to ensure you can hear surrounding sounds, including alarms and warning signals.
  - Be aware of how sounds that you rely on as reminders or warnings may vary in character when using the headphones.

Do NOT use the headphones if they emit any loud unusual noise. If this happens, turn the

- headphones off and contact OneOdio customer service.

- Remove headphones immediately if you experience a warming sensation or loss of audio.
- Do NOT use mobile phone adapters to connect headphones to airplane seat jacks, as this could result in injury or property damage due to overheating.
- Do NOT use the headphones as aviation communication headsets except in case of emergency.
  - No incoming audio will be heard with a discharged or improperly installed battery. This could result in the potential of missed communications while piloting an aircraft.
  - Extremely loud ambient noise levels common to many propeller-driven aircraft may impair your ability to receive incoming audio communications, particularly during takeoff and climb out.
  - The headphones are not engineered for noise conditions, altitude, temperature or other environmental conditions common in non-commercial aircraft, resulting in possible interference to critical communications.



Contains small parts which may be a choking hazard. Not suitable for children under age 3.



This product contains magnetic material. Consult your physician on whether this might affect your implantable medical device.

- To reduce the risk of fire or electrical shock, do NOT expose this product to rain, liquids or moisture.
- Do NOT make unauthorized alterations to this product.
- Use this product only with an agency approved power supply which meets local regulatory requirements (e.g., UL, CSA, VDE, CCC).
- Do not expose products containing batteries to excessive heat (e.g. from storage in direct sunlight, fire or the like).

## REGULATORY INFORMATION

**NOTE:** This equipment has been tested and found to comply with the limits for a Class B digital device, pursuant to Part 15 of the FCC Rules.

These limits are designed to provide reasonable protection against harmful interference in a residential installation. This equipment generates, uses, and can radiate radio frequency energy and, if not installed and used in accordance with the instructions, may cause harmful interference to radio communications.

However, there is no guarantee that interference will not occur in a particular installation. If this equipment does cause harmful interference to radio or television reception, which can be determined by turning the equipment off and on, the user is encouraged to try to correct the interference by one or more of the following measures:

- Reorient or relocate the receiving antenna.
- Increase the separation between the equipment and receiver.
- Connect the equipment into an outlet on a circuit different from that to which the receiver is connected.
- Consult the dealer or an experienced radio/TV technician for help.

Changes or modifications not expressly approved by YI ZHAO (SHENZHEN) CO.,LIMITED. could void the user's authority to operate this equipment.

This device complies with part 15 of the FCC Rules and with Industry Canada license-exempt RSS standard(s). Operation is subject to the following two conditions: (1) This device may not cause harmful interference, and (2) this device must accept any interference received, including interference that may cause undesired operation. This device complies with FCC and Industry Canada radiation exposure limits set forth for general population. It must not be co-located or operating in conjunction with any other antenna or transmitter.

Meets IMDA Requirements.

## **CAN ICES-3 (B)/NMB-3(B)**

### **Management Regulation for Low-power Radio-frequency Devices**

#### **Article XII**

According to “Management Regulation for Low-power Radio-frequency Devices” without permission granted by the NCC, any company, enterprise, or user is not allowed to change frequency, enhance transmitting power or alter original characteristic as well as performance to an approved low power radio-frequency devices.

#### **Article XIV**

The low power radio-frequency devices shall not influence aircraft security and interfere legal communications; If found, the user shall cease operating immediately until no interference is achieved. The said legal communications means radio communications operated in compliance with the Telecommunications Act.

The low power radio-frequency devices must be susceptible with the interference from legal communications or ISM radio wave radiated devices.

DON'T attempt to remove the rechargeable lithium-ion battery from this product. Contact your local Oneodio retailer or other qualified professional for removal.

**CE** YI ZHAO (SHENZHEN) CO., LIMITED. hereby declares that this product is in compliance with the essential requirements and other relevant provisions of Directive 2014/53/EU and all other applicable EU directive requirements. The complete declaration of conformity can be found at: **[www.oneodio.com](http://www.oneodio.com)**

**For Europe:**

**Frequency band of operation**

**2400 to 2483.5 MHz:**

**Bluetooth:** Maximum transmit power less than 20dBm EIRP.



**Please dispose of used batteries properly, following local regulations. Do not incinerate.**

## **REGULATORY INFORMATION**



Information on electrical and electronic equipment

The following notice is aimed at private end users who use electrical and/or electronic devices.

1. Separate collection of old devices

Electrical and electronic equipment that has become waste is referred to as waste equipment. Owners of old devices must collect them separately from unsorted municipal waste. In particular, old devices do not belong in household waste, but in special collection and return systems.

2. Batteries and rechargeable batteries

As a rule, owners of old devices must separate old batteries and accumulators that are not enclosed by the old device from it before handing them over to a collection point. This

does not apply if the old devices are handed over to public waste disposal authorities and are separated there from other old devices in order to prepare them for reuse.

### 3. Options for returning old devices

If you own old devices, you can hand them over to the options set up and available by public waste disposal authorities for the purpose of proper disposal of old devices. It may also be possible to hand in electrical and electronic equipment there for the purpose of reusing the equipment. You can obtain more detailed information on this from the respective collection or collection point.

### 4. Privacy Notice

Old devices often contain sensitive personal data. This applies in particular to information and telecommunications technology devices such as computers and smartphones. In your own interest, please note that each end user is responsible for deleting the data on the old devices to be disposed of.

### 5. Meaning of the crossed-out dustbin symbol

The symbol of a crossed-out garbage can, which is regularly shown on electrical and electronic devices, indicates that the device in question must be collected separately from unsorted municipal waste at the end of its service life.



Names and Contents of Toxic or Hazardous Substances or Elements						
Toxic or Hazardous Substances and Elements						
Part Name	Lead (Pb)	Mercury (Hg)	Cadmium (Cd)	Hexavalent (CR(VI))	Polybrominated Biphenyl (PBB)	Polybrominated diphenylether (PBDE)
PCBs	X	0	0	0	0	0
Metal Parts	X	0	0	0	0	0
Plastic Parts	0	0	0	0	0	0
Speaker	X	0	0	0	0	0
Cables	X	0	0	0	0	0

This table is prepared in accordance with the provisions of SJ/T 11364.

0: Indicates that this toxic or hazardous substance contained in all of the homogeneous materials for this part is below the limit requirement of GB/T 26572.  
X: Indicates that this toxic or hazardous substance contained in at least one of the homogeneous materials used for this part is above the limit requirement of GB/T 26572.

**Charging temperature range:** 0° C – 45° C

**Discharging temperature range:** -20° C – 60° C

**EC REP**

C&E Connection E-Commerce (DE) GmbH  
Add.: Zum Linnegraben 20, 65933, Frankfurt am  
Main, Germany  
Tel. +4906927246648  
E-Mail: info@ce-connection.de

**UK REP**

APEX CE SPECIALISTS LIMITED  
Add.: 89 Princess Street, Manchester, M1 4HT, UK  
Tel. +441616371080  
E-Mail: info@apex-ce.com

Manufacturer: YI ZHAO (SHENZHEN) CO., LIMITED  
Add.: 6th Floor, T3 Creative Building, Shenzhen Colorful  
Huiwei Cultural And Creative Expo City, No. 5010 Baoan  
Avenue, Caowei Community, Hangcheng Street, Baoan  
District, Shenzhen.

## UK Declaration of Conformity

Hereby, YI ZHAO (SHENZHEN) CO., LIMITED declares that the product type Y80B is in compliance with following Directives: Radio Equipment Regulations 2017, Electrical Equipment (Safety) Regulations 2016 and The Restriction of the Use of Certain Hazardous Substances in Electrical and Electronic Equipment Regulations 2012. The full text of the UK declaration of conformity is available at the following internet address: [www.oneodio.com](http://www.oneodio.com)  
[info@oneodio.com](mailto:info@oneodio.com)



1. Use careful with the earphone maybe possible excessive sound pressure from earphones and headphones can cause hearing loss.
2. Caution: risk of explosion if battery is replaced by an incorrect type. Dispose of used batteries according to the instructions.
3. The device complies with RF specifications when the device used at 0mm form your body.

Manufacturer's Name: YI ZHAO (SHENZHEN) CO., LIMITED

Product: Wireless headphone

Model number: Pro 10

## FCC Warning

This device complies with part 15 of the FCC Rules. Operation is subject to the following two conditions:(1) This device may not cause harmful interference, and (2) this device must accept any interference received, including interference that may cause undesired operation.

Any Changes or modifications not expressly approved by the party responsible for compliance could void the user's authority to operate the equipment.

This equipment has been tested and found to comply with the limits for a Class B digital device, pursuant to part 15 of the FCC Rules. These limits are designed to provide reasonable protection against harmful interference in a residential installation. This equipment generates uses and can radiate radio frequency energy and, if not installed and used in accordance with the instructions, may cause harmful interference to radio communications. However, there is no guarantee that interference will not occur in a particular installation. If this equipment does cause harmful interference to radio or television reception, which can be determined by turning the equipment off and on, the user is encouraged to try to correct the interference by one or more of the following measures:

- Reorient or relocate the receiving antenna.
- Increase the separation between the equipment and receiver.
- Connect the equipment into an outlet on a circuit different from that to which the receiver is connected.
- Consult the dealer or an experienced radio/TV technician for help.

The device has been evaluated to meet general RF exposure requirement. The device can be used in portable exposure condition without restriction.



# Share-Port Function



3.5 mm



6.35 mm



3.5 mm



3.5 mm

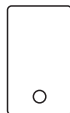

# 1



# Ergonomic Design

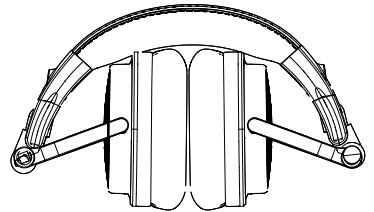
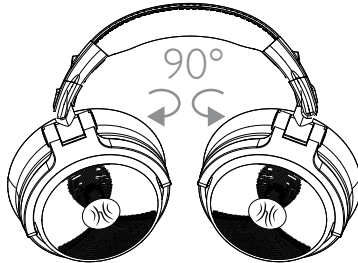

# 2

**1.2 m**

**3.5 mm to 3.5 mm cable with microphone**

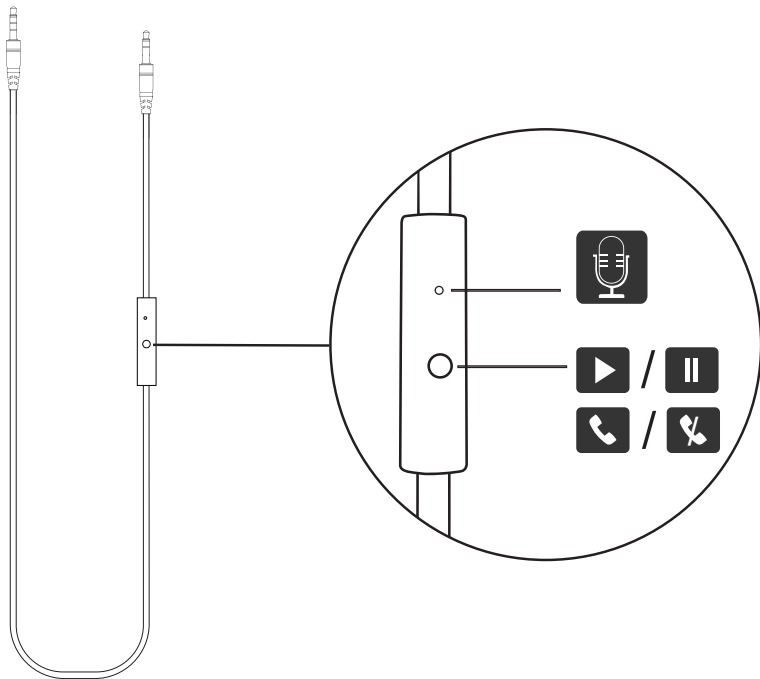

**3**



# 2 m - 3 m

## 3.5 mm to 6.35 mm audio cable

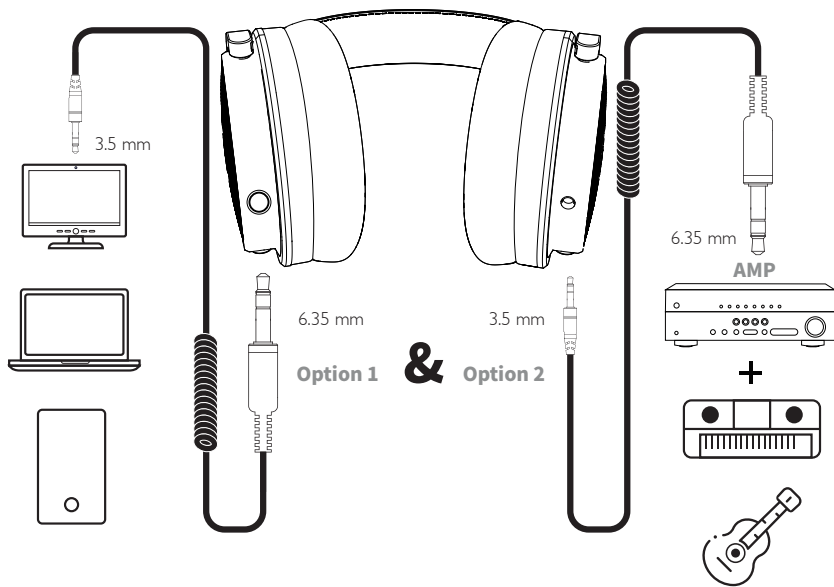

# 4



OneOdio

*The power of music !*



# 1.2 m

## 3.5 mm to 3.5 mm cable with microphone

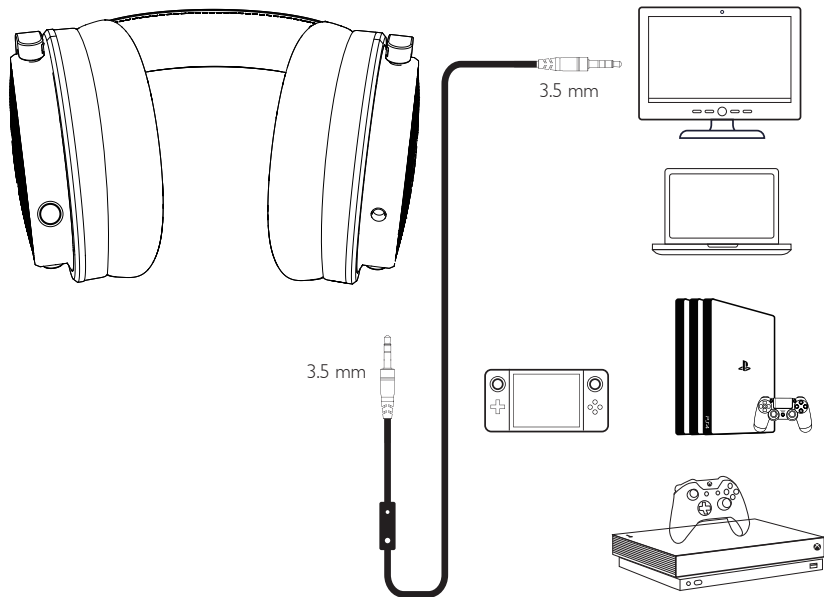

# 5

Specifications / Spezifikationen / 製品の仕様 /

Spécification / Especificaciones / Specifiche

<p><b>Driver:</b> <b>Lautsprecher:</b> <b>ドライバー:</b> <b>Haut-parleur:</b> <b>Altavoz:</b> <b>Altoparlante:</b></p>	<p>50 mm</p>	<p><b>Frequency Response:</b> <b>Frequenzgang:</b> <b>再生周波数:</b> <b>Réponse en fréquence:</b> <b>Respuesta en frecuencia:</b> <b>Risposta in Frequenza:</b></p>	<p>20 Hz - 40 kHz</p>
<p><b>Sensitivity:</b> <b>Empfindlichkeit:</b> <b>感度:</b> <b>Sensibilité:</b> <b>Sensibilidad:</b> <b>Sensibilità:</b></p>	<p>110 dB ± 3dB</p>	<p><b>Max input power:</b> <b>Max. Eingangsleistung:</b> <b>最大入力:</b> <b>Max Puissance:</b> <b>Potencia máxima de entrada:</b> <b>Potenza Massima d'Ingresso:</b></p>	<p>30 mW</p>
<p><b>Plug Type:</b> <b>Stecker Typ:</b> <b>プラグ:</b> <b>Type de prise:</b> <b>Tipo de enchufe:</b> <b>Tipo di Spina:</b></p>	<p>3.5 mm &amp; 6.35 mm Stereo</p>	<p><b>Impedance:</b> <b>Impedanz:</b> <b>インピーダンス:</b> <b>Impédance:</b> <b>Impedancia:</b> <b>Impedenza:</b></p>	<p>32 Ω</p>

## Accessories / Zubehör / パッケージ内容 / Accessories / Accesorios / Accessori

<b>Cable1:</b> 3.5 mm to 3.5 mm cable with microphone (1.2 m)	<b>Kabel1:</b> 3,5 mm auf 3,5 mm Stecker mit Mic (1.2 m)
<b>Cable2:</b> 3.5 mm to 6.35 mm coiled cable (2 m-3 m)	<b>Kabel2:</b> 3,5 mm auf 6,35 mm Stecker (2 m - 3 m)
<b>Portable bag</b>	<b>Zugbeutel</b>
<b>User manual</b>	<b>Bedienungsanleitung</b>

<b>ケーブル1:</b> 3.5 mm マイク付きオーディオケーブル(1.2 m)	<b>Câble1:</b> Prise 3,5 mm vers 3,5 mm avec micro (1,2 m)
<b>ケーブル2:</b> 3.5 mmミニ-6.35mm標準 カールコード(2 m - 3 m)	<b>Cable2:</b> Prise 3,5 mm vers 6,35 mm (de 2 m à 3 m).
<b>キャリーポーチ x 1</b>	<b>Pochette de Transport</b>
<b>取扱説明書 x 1</b>	<b>Manuel d'Utilisation</b>

<b>Cable1:</b> Conjuntor de cables 3,5 mm a 3,5 mm con micrófono (1,2 m)
<b>Cable2:</b> Conjuntor de cables 3,5 mm a 6,35 mm (2 m-3 m)
<b>Bolsa con cordón</b>
<b>Manual de instrucciones</b>

<b>Cavo 1:</b> Cavo da 3,5 mm a 3,5 mm con microfono (1,2 m)
<b>Cavo 2:</b> Cavo a Spirale da 3,5 mm a 6,35 mm (2 m - 3 m)
<b>Borsa per Cuffia</b>
<b>Manuale d'Utente</b>

# Limited Warranty / Eingeschränkte Garantie / 保証書 / Garantie limitée / Garantía limitada / Servizio di Garanzia

Our friendly customer service team are ready and waiting to help. Here is how you can contact us:

Unser freundliches Kundenservice-Team ist bereit, Ihnen zu bedienen. So können Sie uns kontaktieren:

私たちのカスタマーサービスチームはいつでもお手伝いします。連絡先は次のとおり:

Notre gentil service client est toujours à votre écoute. Vous pouvez nous contacter par une des manières suivantes:

Nuestro amable equipo de atención al cliente está listo y esperando para ayudarle:

Il nostro team post-vendita sarà pronto a servirsi in qualsiasi momento, le seguenti sono le nostre informazioni di contatto:

✉ Global: [info@oneodio.com](mailto:info@oneodio.com)

India: [support@oneodio.in](mailto:support@oneodio.in)

🌐 Global: [oneodio.com/pages/support](https://oneodio.com/pages/support)

Japan: [oneodio.jp/pages/support](https://oneodio.jp/pages/support)

India: [oneodio.in/pages/support](https://oneodio.in/pages/support)

☎ Global: +85269403848 (Mon to Fri 9:00 am-6:30 pm, UTC +8 HKT)

India: +91-7676831995 (9:30 to 17:30 active time, IST, Mon to Fri)



C&E Connection E-Commerce (DE) GmbH  
Add.: Zum Linnegraben 20, 65933, Frankfurt am Main, Germany  
Tel.: +4906927246648  
Email: info@ce-connection.de



APEX CE SPECIALISTS LIMITED  
Add.: 89 Princess Street, Manchester, M1 4HT, UK  
Tel.: +441616371080  
Email: info@apex-ce.com

Manufacturer: YI ZHAO (SHENZHEN) CO., LIMITED

Add.: 6th Floor, T3 Creative Building, Shenzhen Colorful Huiwei Cultural and Creative Expo City, No. 5010 Baoan Avenue, Caowei Community, Hangcheng Street, Baoan District, Shenzhen City, Guangdong Province, China.

Email: info@oneodio.com  
Tel.: +85269403848

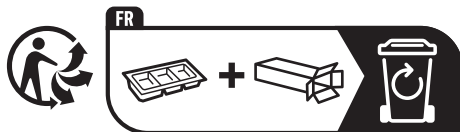

Points de collecte sur [www.quefairedemesdechets.fr](http://www.quefairedemesdechets.fr)  
Privilégiez la réparation ou le don de votre appareil !



Made in China