

DRAPER®

INSTRUCTIONS FOR 200mm 250W 230V Two Wheel Bandsaw

Stock No. 13773

Part No. BS200A

IMPORTANT: PLEASE READ THESE INSTRUCTIONS CAREFULLY TO ENSURE THE SAFE AND EFFECTIVE USE OF THIS PRODUCT.



CE

DRAPER®

GENERAL INFORMATION

These instructions accompanying the product are the original instructions. This document is part of the product, keep it for the life of the product passing it on to any subsequent holder of the product. Read all these instructions before assembling, operating or maintaining this product.

This manual has been compiled by Draper Tools describing the purpose for which the product has been designed, and contains all the necessary information to ensure its correct and safe use. By following all the general safety instructions contained in this manual, it will ensure both product and operator safety, together with longer life of the product itself. All photographs and drawings in this manual are supplied by Draper Tools to help illustrate the operation of the product. Whilst every effort has been made to ensure the accuracy of information contained in this manual, the Draper Tools policy of continuous improvement determines the right to make modifications without prior warning.

1. TITLE PAGE

1.1 INTRODUCTION:

USER MANUAL FOR:

200mm 250W 230V TWO WHEEL BANDSAW

Stock no. 13773

Part no. BS200A

1.2 REVISIONS:

Date first published October 2011

As our user manuals are continually updated, users should make sure that they use the very latest version.

Downloads are available from: <http://www.drapertools.com/b2c/b2cmanuals.pgm>

DRAPER TOOLS LIMITED

HURSLEY ROAD

CHANDLER'S FORD

EASTLEIGH

HAMPSHIRE

SO53 1YF

UK

WEBSITE: www.draper.co.uk

PRODUCT HELPLINE: +44 (0) 23 8049 4344

GENERAL FAX: +44 (0) 23 8026 0784

1.3 UNDERSTANDING THIS MANUALS SAFETY CONTENT:

WARNING! Information that draws attention to the risk of injury or death.

CAUTION! Information that draws attention to the risk of damage to the product or surroundings.

1.4 COPYRIGHT © NOTICE:

Copyright © Draper Tools Limited.

Permission is granted to reproduce this publication for personal & educational use only.

Commercial copying, redistribution, hiring or lending is prohibited.

No part of this publication may be stored in a retrieval system or transmitted in any other form or means without written permission from Draper Tools Limited.

In all cases this copyright notice must remain intact.

2. CONTENTS

2.1 CONTENTS

<i>Page content</i>	<i>Page</i>
1 TITLE PAGE	
1.1 INTRODUCTION	2
1.2 REVISION HISTORY	2
1.3 UNDERSTANDING THIS MANUAL	2
1.4 COPYRIGHT NOTICE	2
2 CONTENTS	
2.1 CONTENTS	3
3 GUARANTEE	
3.1 GUARANTEE	4
4 INTRODUCTION	
4.1 SCOPE	5
4.2 SPECIFICATION	5
4.3 HANDLING & STORAGE	5
5 HEALTH & SAFETY INFORMATION	
5.1 GENERAL SAFETY INSTRUCTIONS FOR POWER TOOL USE	6
5.2 SPECIFIC SAFETY INSTRUCTIONS FOR LATHE USE	8
5.3 CONNECTION TO THE POWER SUPPLY	9A
6 TECHNICAL DESCRIPTION	
6.1 IDENTIFICATION	10B
6.2 MAIN COMPONENT DESCRIPTIONS	10A
7 UNPACKING & CHECKING	
7.1 PACKAGING	11
7.2 WHAT'S IN THE BOX?	11
8 PREPARING THE BANDSAW	
8.1 ASSEMBLING THE WORK TABLE	12
9 SETTING THE BANDSAW	
9.1 SETTING THE SQUARE SQUARE	13
9.2 TILTING THE TABLE	13
9.3 HEIGHT ADJUSTMENT	13
9.4 ADJUSTING THE BLADE GUIDES AND BACK UP BEARING	14
9.5 NO-VOLT ON/OFF SWITCH	15
9.6 DUST EXTRACTION OUTLET	15
9.7 BLADE TRACKING	15
9.8 BLADE REPLACEMENT & TENSION	16
9.9 RIP FENCE	17
9.10 MITRE GUIDE	17
10 TIPS ON USING YOUR BANDSAW	18
11 OPTIONAL ACCESSORIES	
11.1 BANDSAW BLADES	19
12 TROUBLESHOOTING	
10.1	20
13 MAINTENANCE	
13.1 SLIDE ADJUSTMENT	21
14 EXPLANATION OF SYMBOLS	
11.1 EXPLANATION OF SYMBOLS	22
15 DISPOSAL	
15.1 DISPOSAL	23
14 GLOSSARY	
14.1 GLOSSARY	24
DECLARATION OF CONFORMITY	ENCLOSED

3. GUARANTEE

3.1 GUARANTEE

Draper tools have been carefully tested and inspected before shipment and are guaranteed to be free from defective materials and workmanship for a period of 12 months from the date of purchase except where tools are hired out when the guarantee period is ninety days from the date of purchase.

A proof of purchase must be provided with the tool.

Should the machine develop any fault, please return the complete tool to your nearest authorized warranty repair agent or contact Draper Tools Limited, Chandler's Ford, Eastleigh, Hampshire, SO53 1YF. England. Telephone Sales Desk: (023) 8049 4333 or Product Helpline (023) 8049 4344.

If upon inspection it is found that the fault occurring is due to defective materials or workmanship, repairs will be carried out free of charge. This guarantee does not apply to normal wear and tear, nor does it cover any damage caused by misuse, careless or unsafe handling, alterations, accident, or repairs attempted or made by any personnel other than the authorised Draper warranty repair agent.

NOTE: If the tool is found not to be within the terms of warranty, repairs and carriage charges will be quoted and made accordingly.

This guarantee applies in lieu of any other guarantee expressed or implied and variations of its terms are not authorised.

Your Draper guarantee is not effective unless you can produce upon request a dated receipt or invoice to verify your proof of purchase within the 12 month period.

Please note that this guarantee is an additional benefit and does not affect your statutory rights.

Draper Tools Limited

4. INTRODUCTION

4.1 SCOPE

This machine is designed to cut wood, wood derived materials and plastics by means of a revolving endless saw band which is carried on two band wheels. The work piece is manually fed on to the saw band. Any other application is considered mis-use.

4.2 SPECIFICATION

Stock no	13773
Part no	BS200A
Motor:	
Rated voltage	230V~
Rated frequency	50Hz
Rated input	250W
Revolutions per minute (no load)	1400min ⁻¹
Maximum throat capacity	200mm
Maximum capacity under guide	225mm
Table size	290x290mm
Blade speed	900M/min
Band saw blade length	1400mm
Sound pressure level	77.4dB(A)
Sound power level	90.4dB(A)
Weight	17.5kg

4.3 HANDLING & STORAGE

Although this machine is small in size, care must still be taken when handling and lifting. Dropping this machine will have an effect on the accuracy and may also result in personal injury. This machine is not a toy and must be respected.

The environment will have a negative result on its operation if you are not careful. If the air is damp, components will rust. If the machine is unprotected from dust and debris; components will become clogged: And if not cleaned and maintained correctly or regularly the machine will not perform at its best.

5. HEALTH & SAFETY INFORMATION

5.1 GENERAL SAFETY INSTRUCTIONS FOR POWER TOOL USE

When using any type of power tool there are steps that should be taken to make sure that you, as the user, remain safe.

Common sense and a respect for the tool will help reduce the risk of injury.

Read the instruction manual fully. Do not attempt any operation until you have read and understood this manual.

Most important you must know how to safely start and stop this machine, especially in an emergency.

Keep the work area tidy and clean. Attempting to clear clutter from around the machine during use will reduce your concentration. Mess on the floor creates a trip hazard. Any liquid spilt on the floor could result in you slipping.

Find a suitable location. If the machine is bench mounted; the location should provide good natural light or artificial lighting as a replacement. Avoid damp and dust locations as it will have a negative effect on the machine's performance.

If the machine is portable; do not expose the tool to rain. In all cases do not operate power tools near any flammable materials.

Beware of electric shock. Avoid contact with earthed surfaces; because they can conduct electricity if there is an electrical fault with the power tool. Always protect the power cable and route it away from danger.

Keep bystanders away. Children, onlookers and passers by must be restricted from entering the work area for their own protection. The barrier must extend a suitable distance from the tool user.

Unplug and house all power tools that are not in use. A power tool should never be left unattended while connected to the power supply. They must be housed in a suitable location, away locked up and from children.

Do not overload or misuse the tool. All tools are designed for a purpose and are limited to what they are capable of doing. Do not attempt to use a power tool (or adapt it in any way) for an application it is not designed for. Select a tool appropriate for the size of the job. Overloading a tool will result in tool failure and user injury: This covers the use of accessories.

Dress properly. Loose clothing, long hair and jewellery are all dangerous because they can become entangled in moving machinery: This can also result in parts of body being pulled into the machine.

Clothing should be close fitted, with any long hair tied back and jewellery and neck ties removed. Footwear must be fully enclosed and have a nonslip sole.

5. HEALTH & SAFETY INFORMATION

Wear personal protective equipment (PPE). Dust, noise, vibration and **swarf** can all be dangerous if not suitably protected against. If the work involving the power tool creates dust or fumes; wear a dust mask. Vibration to the hand, caused by operating some tools for longer periods must be protected against. Wear vibration reducing gloves and allow long breaks between uses. Protect against dust and **swarf** by wearing approved safety goggles or a face shield. These are some of the more common hazards and preventions; however, always find out what hazards are associated with the machine/work process and wear the most suitable protective equipment available.

Do not breathe contaminated air. If the work creates dust or fumes; connect the machine (if possible) to an extraction system either locally or remotely. Working outdoors can also help if possible.

Move the machine as instructed. If the machine is hand held, do not carry it by the power supply cable. If the product is heavy; employ a second or third person to help move it safely or use a mechanical device. Always refer to the instructions for the correct method.

Do not overreach. Extending your body too far can result in a loss of balance and you falling. This could be from a height or onto a machine and will result in injury.

Maintain your tools correctly. A well maintained tool will do the job safely. Replace any damaged or missing parts immediately with original parts from the manufacturer. As applicable; keep blades sharp; moving parts clean, oiled or greased; handles clean; and emergency devices working.

Wait for the machine to stop. Unless the machine is fitted with a safety brake; some parts may continue to move due to momentum. Wait for all parts to stop; then unplug it from the power supply before making any adjustments, carrying out maintenance operations or just finishing using the tool.

Remove and check setting tools. Some machinery requires the use of additional tools or keys to set, load or adjust the power tool. Before starting the power tool always check to make certain they have been removed and are safely away from the machine.

Prevent unintentional starting. Before plugging any machine in to the power supply, make sure the switch is in the OFF position. If the machine is portable; do not hold the machine near the switch and take care when putting the machine down; that nothing can operate the switch.

Carefully select an extension lead. Some machines are not suitable for use with extension leads. If the tool is designed for use outdoors; use an extension lead also suitable for that environment. When using an extended lead, select one capable of handling the current (amps) drawn by the machine in use. Fully extend the lead regardless of the distance between the power supply and the tool. Excess current (amps) and a coiled extension lead will both cause the cable to heat up and can result in fire.

Concentrate and stay alert. Distractions are likely to cause an accident. Never operate a power tool if you are under the influence of drugs (prescription or otherwise), including alcohol or if you are feeling tired. Being disorientated will result in an accident.

5. HEALTH & SAFETY INFORMATION

Have this tool repaired by a qualified person. This tool is designed to conform to the relevant international and local standards and as such should be maintained and repaired by someone qualified; using only original parts supplied by the manufacturer: This will ensure the tool remains safe to use.

5.2 SPECIFIC SAFETY INSTRUCTION FOR BANDSAW USE

Do not use saw bands which are damaged or deformed.

Replace table insert when worn.

Connect bandsaws to a dust collecting device when sawing wood.

Do not operate the machine when the door or guard protecting the saw band is open.

Take care; the selection of the saw band and the speed depends on the material to be cut.

Do not clean the saw band whilst it is in motion.

Wear suitable personal protective equipment, when necessary; this could include:

Hearing protection to reduce the risk of Induced hearing loss.

Respiratory [breathing] protection to reduce the risk of inhalation of harmful dust;

Gloves for handling the saw band and rough material.

Always keep hands and fingers away from the saw band, especially when coming to the end of a cut.

Use a push stick or piece of scrap wood to do the pushing and guiding when sawing small pieces which require the fingers to be close to the saw band.

Switch the machine off and let the blade come to a stop before removing scrap pieces from the table.

Make all adjustments and set up with the power off and plug removed from power supply.

This includes tilting the table, adjusting the saw band guards, guide, tension and tracking.

Guards must be in place and securely fastened when performing any operation.

Securely lock all adjustable parts so they cannot move during operation. This will prevent distraction from the operation.

When sawing curves, make relief cuts to allow removal of scrap material. This will help prevent undue twisting or binding of the saw blade. The relief cuts are made before starting the curved saw cut.

Hold material firmly and feed into the band at a moderate speed.

Be sure to use the correct band size and type for the application.

Do not saw any material that does not have a flat surface, unless a suitable support is used.

Permanently fix the bandsaw to a bench or stand before performing cutting operations.

Use in a well ventilated area to minimise airborne dust. Use of a suitable extraction device and PPE equipment is required.

Before freeing any jammed material turn switch off, disconnect from power supply and wait for all moving parts to stop.

Before starting to cut, watch and listen to the saw while it runs. If it makes an unfamiliar noise or vibrates excessively, stop immediately. Turn the saw off and disconnect from the power supply. Do not attempt to use the saw until the problem has been identified and rectified.

5. HEALTH & SAFETY INFORMATION

Repair or servicing required on this product should be carried out by a qualified service agent. When servicing use only identical replacement parts.

When straight cutting against the fence use a push stick;

During transportation the saw band guard should be fully down and close to the table;

When bevel-cutting with the table inclined, place the guide on the lower half of the table;

When cutting round timber use a suitable holding device to prevent twisting of the workpiece;

Lifting and transportation must be carried out using the indicated points only;

Do not use guarding for handling or transportation.

Move the adjustable guard as to the workpiece as practicable;

Use the correct adjustment of the saw band guards.

5.3 CONNECTION TO THE POWER SUPPLY

Make sure the power supply information on the machine's rating plate are compatible with the power supply you intend to connect it to.

This lathe comes supplied with a UK standard 3 pin plug fitted. It is designed for connection to a domestic power supply rated at 230V AC.

Because it is constructed mostly of metal parts, it is a Class 1 machine; meaning, it must have an earth connection in the power supply. This is to prevent electrocution in the event of a failure.

Apart from replacing the fuse in the plug, no other electrical work is recommended on this lathe.

6. TECHNICAL DESCRIPTION

6.1 IDENTIFICATION

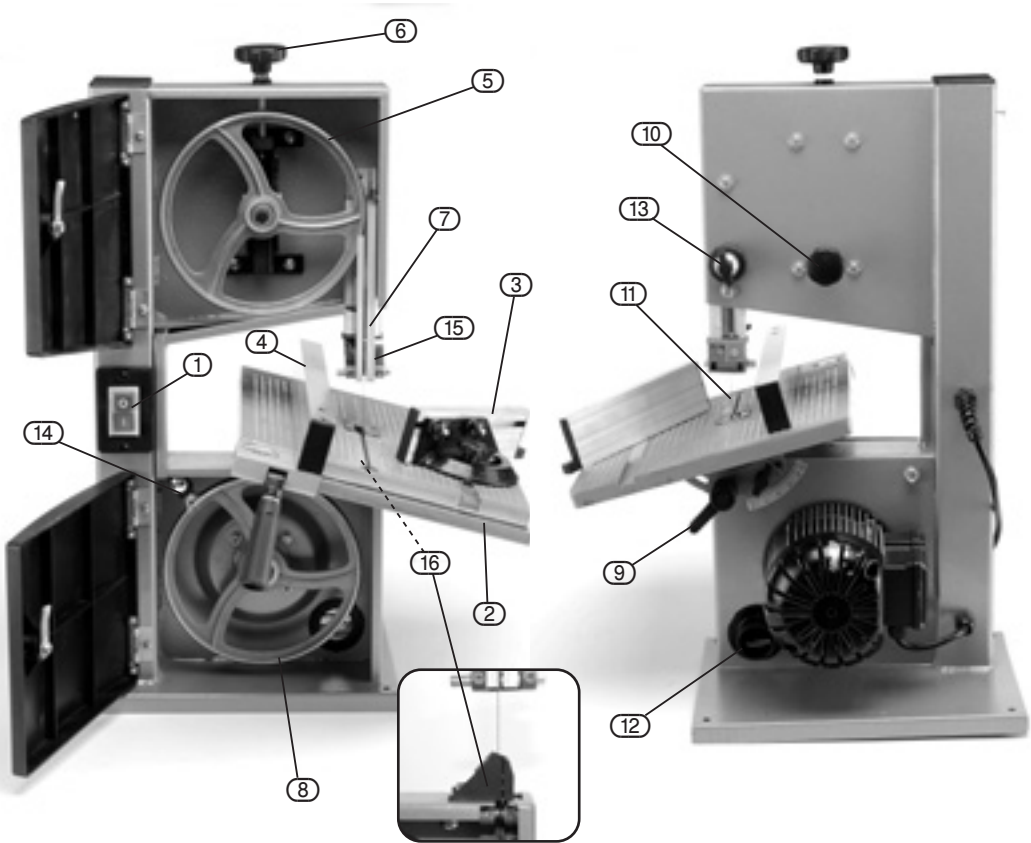

① No-volt on/off switch.

② Table.

③ Mitre guide.

④ Rip fence.

⑤ Upper wheel.

⑥ Blade tension knob.

⑦ Upper blade guard.

⑧ Lower wheel.

⑨ Table tilt locking knob.

⑩ Blade tracking knob.

⑪ Blade.

⑫ Dust outlet port.

⑬ Blade guide height adjuster.

⑭ Blade brush.

⑮ Upper blade guard and back bearings.

⑯ Lower blade guard and back bearings.

6. TECHNICAL DESCRIPTION

6.2 MAIN COMPONENT DESCRIPTIONS

The **EMERGENCY STOP BUTTON**; when pushed it will stop all power to the motor. After operating the button it is necessary to release it again to restore the power.

7. UNPACKING & CHECKING

7.1 PACKAGING

Carefully remove the bandsaw from the packaging and examine it for any sign of damage that may have happened during shipping. Lay the contents out and check them against the parts shown below. If any part is damaged or missing; please contact the Draper Helpline (the telephone number appears on the Title page) and do not attempt to use the lathe.

The packaging material should be retained at least during the guarantee period: in case the machine needs to be returned for repair.

Warning! Some of the packaging materials used may be harmful to children. Do not leave any of these materials in the reach of children.

If any of the packaging is to be thrown away, make sure they are disposed of correctly; according to local regulations.

7.2 WHAT'S IN THE BOX?

As well as the bandsaw; there are several parts not fitted or attached to it.

1 x open ended spanner

1 x push stick

1 x hex key

8. PREPARING THE BANDSAW

8.1 ASSEMBLING THE WORK TABLE - FIGS. 1 - 2

To slide the table (3) past the blade, the screw (3.1) and wing nut (3.2) must first be removed.

Position the slot in the tilt scale over the arc (3.3) on the back of the saw housing.

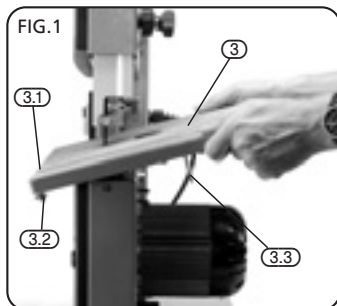

When in place, secure with locking handle (9).

Note: The BS190B bandsaw must be securely mounted to a flat stable surface. (Fixings not supplied).

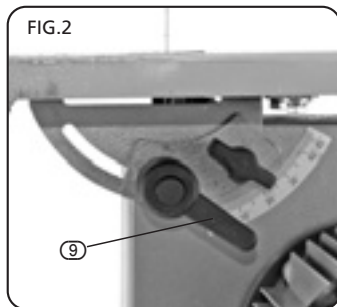

9. SETTING THE BANDSAW

WARNING: before making any checks, adjustments or repairs, ensure the power supply is switched off and the plug has been removed from the socket.

9.1 SETTING THE TABLE SQUARE - FIG. 3

Using a small engineers square resting against the edge of the blade and the table, check to see if the blade is square to the table. If adjustment is required, loosen locking handle (9), and adjust the screw and locking nut (9.1), set the table square and retighten (9) and set (9.1) so it touches the housing and lock the nut.

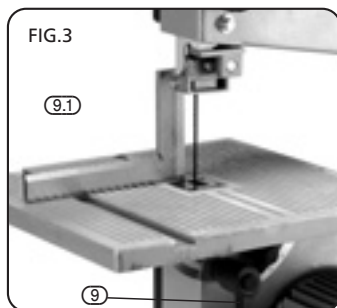

9.2 TILTING THE TABLE - FIG. 4

The angle of the table can be adjusted between 0 and 45°. Loosen locking handle (9) and set the angle on the guide scale (9.1) and pointer (9.2).

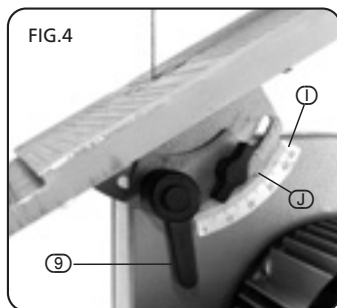

9.3 HEIGHT ADJUSTMENT - FIG. 5

The blade guide can be adjusted (13) and should be set so that it just clears the workpiece whilst cutting. Always adjust the guide assembly to suit the workpiece before each operation.

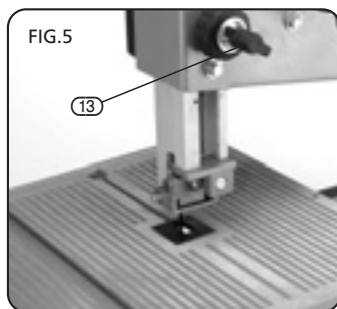

9. SETTING THE BANDSAW

9.4 ADJUSTING THE BLADE GUIDES AND BACK UP BEARING - FIGS. 6 - 8

Note: The upper and lower blade guides and back up bearings support the bandsaw blade during cutting operations. The guides and bearings should be checked and adjusted whenever a different blade is fitted.

The upper back up bearing (15.1) Fig.6. should be adjusted first. Loosen the hexagon set screw (15.2) located to the side of the bearing.

Adjust the back up bearing to within 1.5mm ($\frac{1}{32}$ ") of the blade and tighten the hexagon set screw. Now repeat this exercise for the lower blade guide assembly. Alter the lower back bearing (16.1). Loosen hex. screws (16.2) and adjust.

Note: The back up bearing supports the back edge of the blade during a cutting operation. The blade should NOT be in contact with the bearings when you stop cutting.

Next adjust the position of the upper blade guide support (15.3) Fig.7. Loosen set screw (15.4) and slide the blade guide support along until the front edge of the blade guides are 1.5mm ($\frac{1}{32}$ ") behind the gullet of the blade. Tighten the set screw.

Repeat this exercise for the lower blade guide.

Adjust the lower blade guide support (16.3). Loosen hex. screws (16.4) and adjust.

IMPORTANT: The blade will be damaged if the blade teeth hit the blade guides whilst the bandsaw is operating. Correct adjustment of the upper and lower blade guards will prevent this from happening.

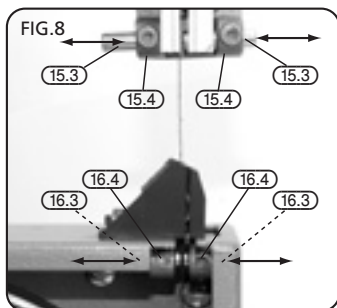
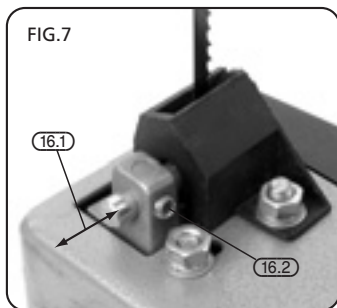
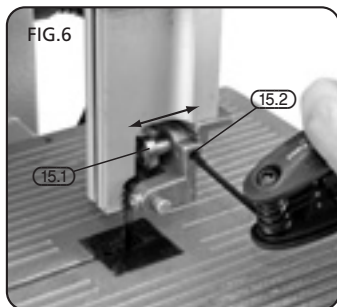

9. SETTING THE BANDSAW

9.5 NO-VOLT ON/OFF SWITCH - FIG. 9

This machine is fitted with a no-volt on/off switch. In the event of a power supply failure, the machine will have to be manually re-started.

To switch the bandsaw 'ON' push I (1.2).

To switch the bandsaw 'OFF' push O (1.1).

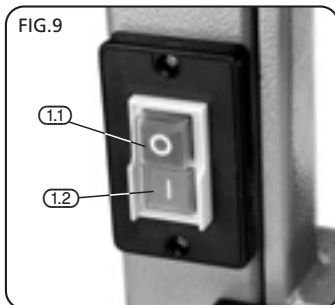

9.6 DUST EXTRACTION OUTLET - FIG. 10

Draper Tools recommends the Bandsaw is connected to a vacuum (Draper Tools Stock No.48499) during operations, to provide fast efficient removal of sawdust from your machine.



9.7 BLADE TRACKING - FIGS. 11 - 12

This should be checked prior to use and adjusted after fitting a new blade.

To open the front of the housing loosen the three bolts with the hexagon wrench provided.

Turn the upper blade wheel (5) clockwise by hand and observe the position of the blade on it. If the blade stays central, no adjustment is required. If the blade wanders towards the front or the rear of the wheel, the tracking will require adjustment. To adjust, turn knob (10) a 1/4 turn clockwise/anticlockwise depending. Then by hand again, turn the wheel clockwise and observe the blade. Only a small amount of movement on the knob will be required.

When the blade is tracked correctly, shut the front cover and tighten the three bolts.

Note: The blade should only be tracked with the correct tension on the blade.



9. SETTING THE BANDSAW

9.8 BLADE REPLACEMENT & TENSION - FIGS. 13 - 14

WARNING: Turn the saw off and disconnect from the power supply before making any adjustments to the blade.

Open the front housing. Loosen the tension knob (6) to release the strain on the blade. Undo the table screw and wing nut (11), so the blade can be removed freely.

Remove the blade (V), taking note the direction of the teeth. Fit the new blade in the centre of the wheels with the teeth facing down. Refit screw (W) and tension the blade. Check the tension on the blade by applying pressure on the side of the blade. The blade is correct when slight movement from side to side is possible with firm finger pressure.

Note: Do not over tighten the blade, excessive tension may cause blade breakage. Too little tension may cause blade slip.

Check the condition of the blade brush when replacing a blade (page 15).

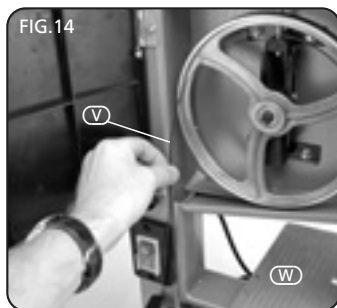
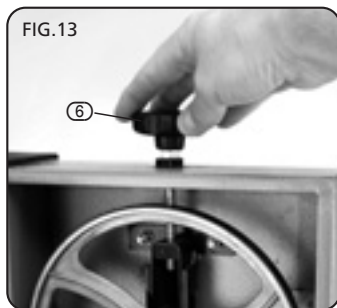
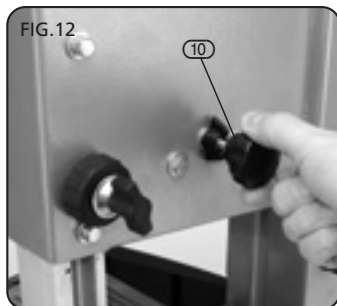

9. SETTING THE BANDSAW

9.9 RIP FENCE - FIG.15

The rip fence can be used as a guide for cutting straight lines or repeated cuts of a similar width. To lock the rip fence in place press down on lever

(4.1).



9.10 MITRE GUIDE - FIG.16

The mitre guide can be used to aid cuts, and adjusted between 0° and 45° as a guide with mitre cuts. Loosen lock knob (3.1) and set the guide on the scale (3.2) and pointer (3.3).

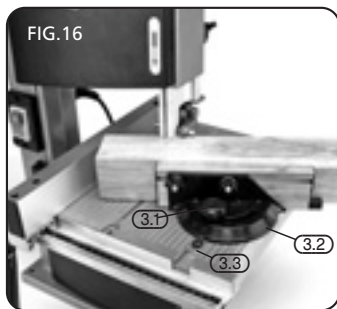

10. TIPS ON USING YOUR BANDSAW

For all cutting operations the upper blade guard should be adjusted to just clear the work being cut (3mm). Not only does this provide the best operator safety, but it also brings the blade guides closer to the work giving more accurate results and easier control.

Use both hands to feed the workpiece to the blade. The work must be held flat on the table at all times to prevent binding of the blade. Use a steady even pressure just sufficient to keep the blade cutting.

Always use a rip fence or mitre guide where possible to eliminate any sideways slip of the work. This is most important when the table is tilted to an angle.

Always plan work ahead. The tradesman's rule is "measure twice, cut once". It is best to finish a cut in one continuous operation, but frequently backtracking will be necessary. Turn off the motor and allow the blade to come to a complete stop before backing the blade out of the cut.

Remember that the blade removes material during the cut. This gap created by the blade is called the kerf and must be allowed for when cutting to exact sizes. Plan your cut so that the kerf is to the scrap side of the line you wish to cut. If necessary, allow a little more for finish sanding.

RIP SAWING

This term refers to the cutting of timber with the grain rather than at a right angle to the grain. You can rip wood freehand to a previously drawn line, but best results are obtained by using the rip fence. If the table is set at a level angle set the rip fence to the left hand side of the blade. This allows you to use your right hand to hold the work firmly against the fence. The width of cut indicator on right hand side of the blade if the width of the workpiece allows it.

With the fence on the downhill side of the table it will help support the work against slipping. The width cut indicator shows the distance between the blade and the rip fence.

CROSS CUTTING

This term refers to cutting of timber at right angles to the grain. This type of cut can also be made freehand but the mitre guide is used to ensure accurate results. The mitre guide can be adjusted to a 45° angle to produce mitre cuts, or with the table tilted as well, compound mitre cuts.

Make sure the work is held firmly against the table and against the face of the mitre guide. Be careful to keep your fingers away from the blade, particularly at the end of the cut.

FREEHAND SAWING

The ease with which many different and varied shapes can be cut is one of the most important features of the bandsaw. Select a blade suitable for cutting the smallest radius in the work you have planned.

When freehand cutting always feed the work slowly so that the blade can follow the line you wish to saw. Make sure not to drag the work off line forcing the blade sideways, or twisting it.

In many cases, it is helpful to rough cut about 6mm away from the line in difficult curves and corners. In the case of very sharp curves which may be too tight for the blade, make relief cuts onto the face of the curve so that these scraps will fall as the final radius is sawn.

11. OPTIONAL ACCESSORIES

The following accessories are available from your local Draper Stockist:

11.1 BANDSAW BLADES:

Stock No.	Part No.	Length	Width	TPI
14253	BB1400	1400mm	1/4"	6
14254	BB1400	1400mm	3/8"	6
14255	BB1400	1400mm	1/4"	24
14259	BB1400	1400mm	1/2"	6

Note: 1/4" and 3/8" Bandsaw blades are suitable for use with this machine.

12. TROUBLESHOOTING

WARNING: For your own safety, turn the switch off and remove the plug from the power supply socket.

PROBLEM	POSSIBLE CAUSE	REQUIRED ACTION
<ul style="list-style-type: none">• Breaking blades.	<ul style="list-style-type: none">• Wrong tension.• Over working blade.• Wrong blade application. • Twisting blade.	<ul style="list-style-type: none">• Adjust blade tension.• Reduce feed rate.• Use narrow blades for cutting thin material or sharp curves, wide blades for thicker material or straight cuts.• Avoid side pressure on blade.
<ul style="list-style-type: none">• Motor will not run.	<ul style="list-style-type: none">• Defective cable or plug.• Defective motor.	<ul style="list-style-type: none">• Replace defective parts.• Consult your service agent. Any attempt to repair this motor may be dangerous unless the repair is carried out by a qualified service agent.
<ul style="list-style-type: none">• Vibration. <p>NOTE: There will always be some vibration when the saw is running due to the motor operation.</p>	<ul style="list-style-type: none">• Increase mounting of saw.• Unsuitable mounting surface. • Loose table.• Loose motor mounting.	<ul style="list-style-type: none">• Refer to the mounting instructions in this manual.• The heavier your work bench is, the less vibration. A plywood workbench is not as good as solid timber.• Tighten table locking knob. Adjust table if necessary.• Tighten mounting screws.
<ul style="list-style-type: none">• Blade runout.	<ul style="list-style-type: none">• Blade guides not aligned.	<ul style="list-style-type: none">• Check blade guide settings as per manual.

IMPORTANT: Please note all repairs/service should be carried out by a qualified person.

13. MAINTENANCE

13.1 SLIDE ADJUSTMENT – FIG. 12

WARNING For your own safety turn switch off and remove plug from power supply before attempting any adjustment or repairs.

CHANGING TYRES

Eventually the rubber tyres on the bandsaw wheels will wear due to the constant contact of the sharp teeth of the blade. Lift the edge of the tyre with a small screwdriver and the tyre can be worked off the wheel easily. We recommend that the two tyres be changed at the same time. (See Spare Parts Listing/Drawing).

BLADE GUIDES

Blade guides should be inspected regularly for wear or chipping. When replacing guides replace all guides at the same time, both upper and lower. (See Spare Parts Listing/Drawing).

BEARINGS

All bearings used in the construction of your bandsaw and its motor are sealed and lubricated for life.

CLEAN OUT

Remove the plug from the socket before carrying out adjustment, servicing or maintenance. Accumulated dust and chips should be removed from inside the bandsaw frequently. Open the front covers and use a brush or vacuum cleaner. At the end of every work session clean sawdust away from the motor vents.

Regular inspection and cleaning reduces the necessity for maintenance operations and will keep your tools in good working condition.

The motor must be correctly ventilated during the tools operation. For this reason avoid blocking the air inlets.

If the replacement of the supply cord is necessary, this has to be done by the manufacturer or his agent in order to avoid a safety hazard.

14. EXPLANATION OF SYMBOLS

14.1 EXPLANATION OF SYMBOLS



Warning! Ejection hazards.
Wear safety goggles



WEEE
Do not dispose of Waste Electrical
& Electronic Equipment in with
domestic rubbish

15. DISPOSAL

15.1 DISPOSAL

- At the end of the machine's working life, or when it can no longer be repaired, ensure that it is disposed of according to national regulations.
- Contact your local authority for details of collection schemes in your area.

In all circumstances:

- Do not dispose of power tools with domestic waste.
- Do not incinerate.
- Do not abandon in the environment.
- Do not dispose of WEEE* as unsorted municipal waste.



* Waste Electrical & Electronic Equipment.

16. GLOSSARY

16.1 GLOSSARY

Alphabetical list of words relating to this manual

1. **KERF**
The material which is removed by the blade in a through cut or the slot produced by the blade in a non-through or partial cut.
2. **LEADING EDGE**
The edge of the workpiece which is pushed into the blade first.
3. **SAW BLADE PATH**
The area of the workpiece directly in line with and moving towards the saw blade edge.
4. **BLADE TOOTH SET**
The distance that the teeth of the saw blade are bent (on set) outward from the side of the blade.
5. **TRAILING EDGE**
The workpiece edge last cut by the saw blade.
6. **WORKPIECE**
The item on which the cutting operation is being performed. The surfaces of the workpiece are commonly referred to as faces, ends and edges.
7. **RESIN**
A sticky sap-based substance that has dried.
8. **CROSS CUT**
A cutting operation made across the grain of the wood.
9. **BEVELLING**
An angle cutting operation through the face of the workpiece.
10. **MITERING**
An angle cutting operation through the face of the workpiece.
11. **COMPOUND CUTTING**
A simultaneous bevel and mitre cutting operation.

- **DRAPER TOOLS LIMITED,**
Hursley Road, Chandler's Ford,
Eastleigh, Hampshire. SO53 1YF. U.K.

- **Helpline:** (023) 8049 4344

- **Sales Desk:** (023) 8049 4333

- **Internet:** www.draper.co.uk

- **E-mail:** sales@drapertools.com

- **Sales Fax:** (023) 8049 4209

- **General Enquiries:** (023) 8026 6355

- **Service/Warranty Repair Agent**

For aftersales servicing or warranty repairs, please contact the Draper Tools Helpline for details of an agent in your local area.

YOUR DRAPER STOCKIST