

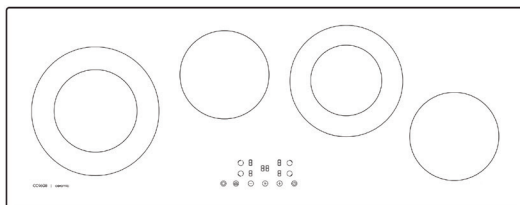

60cm & 90cm Ceramic Cooktop
Model ICC6GE3 (60cm) & CC96GB (90cm)

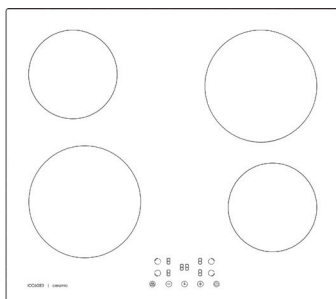

**INSTRUCTION /
INSTALLATION MANUAL**

PLEASE READ THE USER MANUAL CAREFULLY BEFORE USE

Product/Installer details

For future reference we suggest that you staple a copy of your purchase receipt here and complete the below so the information is always at hand.

Product Details

Model number: _____

Description: _____

Serial number: _____

(Located on the product rating label)

Purchase Details

Date of purchase: _____

Place of purchase: _____

Store name: _____

Address: _____

Telephone: _____

Invoice/receipt number: _____

Installation Details

Electrical date of installation: _____

Electrician Installers Details: Company/Installers Name: _____

Licence Number: _____

Telephone Number: _____

Gas date of installation: _____

Gas installers details: Company/Installers Name: _____

Licence Number: _____

Telephone Number: _____

Plumbing date of installation: _____

Plumbers installers details: Company/Installers Name: _____

Licence Number: _____

Telephone Number: _____

Dear Customer,

Congratulations on the purchase of your new product from
Glen Dimplex Australia Pty Ltd.

We recommend you please take some time to read the instruction manual thoroughly to familiarise yourself with the functionality and operations to ensure optimum performance of your new appliance.

After reading the manual, please store it in a safe and accessible location for future reference.

Installation

The installation of your new appliance must be carried out by a qualified installer/technician in accordance to local regulations.

The packaging of your appliance has been selected from environmentally friendly materials and can usually be recycled. Please ensure these are disposed of correctly.

Customer Care

Our Customer Care centre is available should you wish to learn more about your appliance in relation to how to use it to its best potential, or tips on cleaning as well as available accessories.

For further details please contact our Customer Care team on
1800 444 357 or email: customercare@hapl.com.au

Thank you

Regards,
Glen Dimplex Australia



CONTENTS

Contents	1
Safety Warnings - Installation	2-3
Safety Warnings - Operation and Maintenance	3-6
Product Overview	7-8
Before using your new cooktop	8
Using the Touch Controls	8
Choosing the right cookware	9
Using your Cooktop	10
Dual Zone Function (for model CC96GB)	11
Locking the controls	12
Residual Heat Indicators	12
Auto Shutdown	12
Using the Timer	13-15
Cooking Guidelines	16-17
Heat Settings	17
Care and Cleaning	18
Troubleshooting Guide - hints and tips	19
Technical Specification	20
Installation - material and dimensions	21
Installation - ventilation and clearances	22
Installation - fixing cooktops to work surface	23
Installation - electrical connection	24

SAFETY WARNINGS

PLEASE READ THE FOLLOWING INSTRUCTIONS CAREFULLY BEFORE USING THE APPLIANCE.

Installation

Electrical Shock Hazard

- Disconnect the appliance from the mains electricity supply before carrying out any work or maintenance on it.
- Connection to a good earth wiring system is essential and mandatory.
- Means for disconnection must be incorporated in the fixed wiring in accordance with the wiring rules.
- Alterations to the domestic wiring system must only be made by a qualified electrician.
- Failure to follow this advice may result in electrical shock or death.

Cut Hazard

- Take care - panel edges are sharp.
- Failure to use caution could result in injury or cuts.

Important safety instructions

- Read these instructions carefully before installing or using this appliance.
- No combustible material or products should be placed on this appliance at any time.
- Please make this information available to the person responsible for installing the appliance as it could reduce your installation costs.
- In order to avoid a hazard, this appliance must be installed according to these instructions for installation.
- This appliance is to be properly installed and earthed only by a suitably qualified person.

SAFETY WARNINGS

- This appliance should be connected to a circuit which incorporates an isolating switch providing full disconnection from the power supply.
- **WARNING:** Use only cooktop guards designed by the manufacturer of the cooking appliance or indicated by the manufacturer of the appliance in the instructions for use as suitable or cooktop guards incorporated in the appliance. The use of inappropriate guards can cause accidents.
- Failure to install the appliance correctly could invalidate any warranty or liability claims.
- Regarding the details of installation, please refer to the section 'Installation'.

Operation and Maintenance

Electrical Shock Hazard

- Do not cook on a broken or cracked cooktop. If the cooktop surface is broken or cracked, switch the appliance off immediately at the mains power supply (wall switch) and contact a qualified technician.
- Switch the cooktop off at the wall before cleaning or maintenance.
- Failure to follow this advice may result in electrical shock or death.

Health Hazard

- This appliance complies with electromagnetic safety standards.

Hot Surface Hazard

- During use, accessible parts of this appliance will become hot enough to cause burns.
- Do not let your body, clothing or any item other than suitable cookware contact the ceramic glass until the surface is cool.
- Metallic objects such as knives, forks, spoons and lids should not be placed on the hob surface since they can get hot.

SAFETY WARNINGS

- Children less than 8 years of age shall be kept away unless continuously supervised.
- Handles of saucepans may be hot to touch. Check saucepan handles do not overhang other cooking zones that are on. Keep handles out of reach of children.
- Failure to follow this advice could result in burns and scalds.

Cut Hazard

- The razor-sharp blade of a cooktop scraper is exposed when the safety cover is retracted. Use with extreme care and always store safely and out of reach of children.
- Failure to use caution could result in injury or cuts.

Important safety instructions

- Never leave the appliance unattended when in use. Boil over causes smoking and greasy spillovers that may ignite.
- Never use your appliance as a work or storage surface.
- Never leave any objects or utensils on the appliance.
- Never use your appliance for warming or heating the room.
- After use, always turn off the cooking zones and the cooktop as described in this manual (i.e. by using the touch controls).
- Do not allow children to play with the appliance or sit, stand, or climb on it.
- Do not store items of interest to children in cabinets above the appliance. Children climbing on the cooktop could be seriously injured.
- Do not leave children alone or unattended in the area where the appliance is in use.

SAFETY WARNINGS

- Children or persons with a disability which limits their ability to use the appliance should have a responsible and competent person to instruct them in its use. The instructor should be satisfied that they can use the appliance without danger to themselves or their surroundings.
- Do not leave children alone or unattended in the area where the appliance is in use.
- Children or persons with a disability which limits their ability to use the appliance should have a responsible and competent person to instruct them in its use. The instructor should be satisfied that they can use the appliance without danger to themselves or their surroundings.
- Do not repair or replace any part of the appliance unless specifically recommended in the manual. All other servicing should be done by a qualified technician.
- Do not use a steam cleaner to clean your cooktop.
- Do not place or drop heavy objects on your cooktop.
- Do not stand on your cooktop.
- Do not use pans with jagged edges or drag pans across the glass surface as this can scratch the glass.
- Do not use scourers or any other harsh abrasive cleaning agents to clean your cooktop, as these can scratch the ceramic glass.
- If the supply cord is damaged, it must be replaced by the manufacturer, its service agent or similarly qualified persons in order to avoid a hazard.
- This appliance is intended to be used in a domestic household environment only! Commercial use of any kind is not covered under the manufacturer's warranty!
- **WARNING:** The appliance and its accessible parts become hot during use.
- Care should be taken to avoid touching heating elements.

SAFETY WARNINGS

- Children less than 8 years of age shall be kept away unless continuously supervised.
- This appliance can be used by children aged from 8 years and above and persons with reduced physical, sensory or mental capabilities or lack of experience and knowledge if they have been given supervision or instruction concerning use of the appliance in a safe way and understand the hazards involved.
- Children shall not play with the appliance. Cleaning and user maintenance shall not be made by children without supervision.
- **WARNING:** Unattended cooking on a cooktop with fat or oil can be dangerous and may result in fire. NEVER try to extinguish a fire with water, but switch off the appliance and then cover flame e.g. with a lid or a fire blanket.
- **WARNING:** Danger of fire: do not store items on the cooking surfaces.
- **WARNING:** If the surface is cracked, switch off the appliance to avoid the possibility of electric shock, for hob surfaces of glass-ceramic or similar material which protect live parts.
- The appliance is not intended to be operated by means of an external timer or separate remote-control system.
- **CAUTION:** The cooking process has to be supervised. A short term cooking process has to be supervised continuously.
- Power cord can't be accessible after installation.

Congratulations on the purchase of your new cooktop. We recommend that you spend some time to read this Instruction / Installation Manual in order to fully understand how to install correctly and operate it.

Read all the safety instructions carefully before use and keep this Instruction / Installation Manual for future reference.

Product Overview – ICC6GE3 & CC96GB

Top View

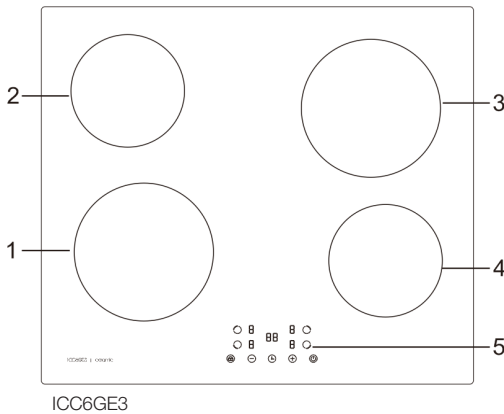

- 1. max. 1800 W zone
- 2. max. 1200 W zone
- 3. max. 1800 W zone
- 4. max. 1200 W zone
- 5. Control panel

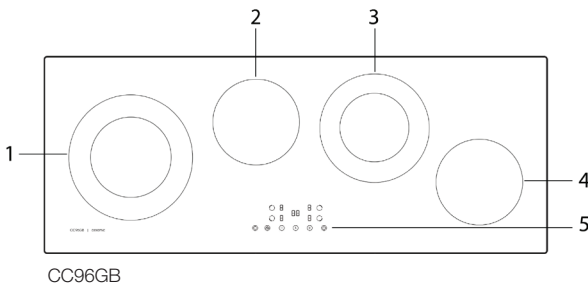

- 1. max. 1100 / 2200 W zone
- 2. max. 1200 W zone
- 3. max. 900 / 1800 W zone
- 4. max. 1200 W zone
- 5. Control panel



Product Overview – ICC6GE3 & CC96GB

The Control Panel

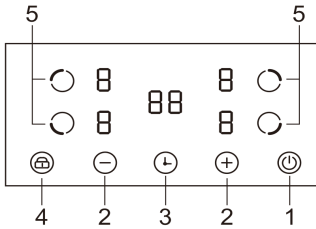

ICC6GE3

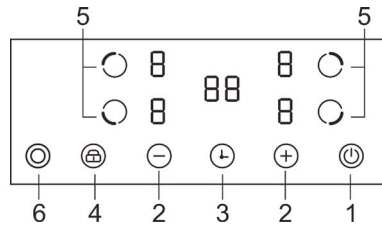

CC96GB

1. ON/OFF switch
2. Select power level
3. Setting the timer
4. Child lock
5. Select heating zone
6. Double zone control

Before using your new Cooktop

- Read this guide, taking special note of the ‘Safety Warnings’ section.
- Remove any protective film that may still be on your Induction cooktop.
- DO NOT use the cooktop if cracked or damaged in any way.

Using the Touch Controls

- The controls respond to touch, so you don’t need to apply any pressure.
- Use the ball of your finger, not its tip. See illustration.
- You will hear a beep each time a touch is registered.
- Make sure the controls are always clean, dry, and that there is no object (e.g. a utensil or a cloth) covering them. Even a thin film of water may make the controls difficult to operate.

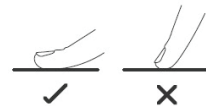

Choosing the right cookware

- Only use cookware with a base suitable for Ceramic cooktop surfaces. Ensure the cookware base is as flat and smooth. Rough and damaged bases can cause scratching of the glass surface. Cookware with concave or convex bases should be avoided as either could affect performance and safety.
- Cookware with aluminium and copper bases should be avoided on ceramic glass surfaces unless coated with a suitable substrate like stainless steel. Prolonged use of cookware made from these materials can cause possible pitting of the ceramic glass surface.
- Cookware should be placed carefully on the ceramic glass surface as heavily placing cookware can cause cracking or breakage of the surface.
- Ensure cookware size is best matched to a coinciding cooking zone size to ensure best performance and energy saving.

Do not use cookware with jagged edges or those with a curved base. Make sure that the base of your pan is smooth, sits flat against the glass.



Ideally cookware should be the same size as the cooking zone. Refer table above. Always centre your pan on the cooking zone.

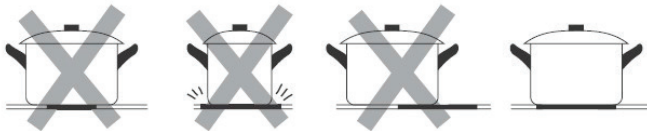

Always lift pans off the cooktop – do not slide, or they may scratch the glass



Using your cooktop

To start cooking

After power on, the buzzer beeps once, all the indicators light up for 1 second then go out, indicating that the cooktop has entered the state of standby mode.

1. Touch the ON/OFF  switch. all the indicators show “-”



2. Place a suitable pan on the cooking zone that you wish to use. Make sure the bottom of the pan and the surface of the cooking zone is clean and dry.

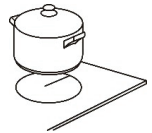

3. Touch the desired heating zone selection control, an indicator next to the key will flash.



4. Select a heat setting by touching the “+” or “-” controls.

- If you don't choose a heat setting within 1 minute, the Induction cooktop will automatically switch off. You will need to start again at step 1.
- You can modify the heat setting at any time during cooking.



When you have finished cooking

1. Touch the desired heating zone selection that you wish to switch off.



2. Turn the cooking zone off by touching “+” or “-” control to “0”. Make sure the display shows “0”.



3. Turn the whole cooktop off by touching the ON/OFF control.



4. Beware of hot surfaces. Each zone is fitted with residual heat indicators and an “H” will show when the each of the cooking zones are too hot to touch. It will disappear when the surface has cooled down to a safe temperature. It can also be used as an energy saving function if you want to heat further pans, use the hotplate that is still hot.

H

Dual Zone Function (for model CC96GB)

The dual zone consists of 2 circuits - the center zone and the outer zone. It can be used in the following modes:

- Center Zone – only first heating unit is turned on
- Extended Zone (Center + Outer) – Both first and second heating circuits are turned on

Upon selecting the cooking zone, only the center zone will be turned ON. To activate the outer zone:

- Touch the selected cooking zone with dual zone function
- Touch dual zone key , the indicator display will show “=”



To cancel the outer zone, press the dual zone key  to turn off the second heating circuit, then select the desired power level by using keys “+” and “-”

Locking the controls

- You can lock the controls to prevent unintended use (for example accidentally turning the cooking zones on).
- When the controls are locked, all the controls except the ON/OFF control are disabled.

To lock the controls

Touch the keylock  control. The timer indicator will show “Lo “.

To unlock the controls

1. Make sure the cooktop is turned on.
2. Touch and hold the keylock  control for 3 seconds.
3. You can now start using your cooktop.



When the cooktop is in lock mode, all the controls are disabled except the ON/OFF, you can always turn the cooktop off with the ON/OFF control in an emergency, but you shall unlock the cooktop first in the next operation.

Residual Heat Indication

When the cooktop has been operating for some time, there will be some residual heat. The letter “H” appears to warn you to keep away from it.

H

Auto Shutdown

Safety feature of the cooktop is auto shut down. This occurs whenever you forget to switch off a cooking zone. The default shutdown times are shown in the table below:

Power level	1	2	3	4	5	6	7	8	9
Default shutdown time (hours)	8	8	8	4	4	4	2	2	2

Using the Timer

You can use the timer in two different ways:

You can use it as a **minute minder**. In this case, the timer **WILL NOT** turn any cooking zone off when the set time has been reached. The second way is to set a **cut-off timer** where the cooking zone **WILL TURN OFF** when the time set is reached. The maximum time that can be set is 99 minutes and can be used on several zones at the same time.

Using the Timer as a Minute Minder

1. Make sure the cooktop is turned on and zone selection key is not activated (zone indication ‘-’ is not blinking).

Note: you can set minute minder before or after cooking zone power setting finished.

2. Touch timer key, “00” will show in the timer display and “0” will blink.



3. Set the time by touching the “+” or “-” controls of the timer (e.g. 5)

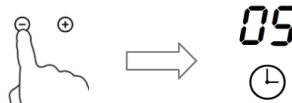

4. Touch timer control again, then “0” will flash.



5. Set the time by touching the “+” or “-”, now the timer you set is 95 minutes.

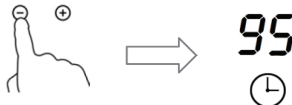

6. When the time is set, it will begin to count down immediately. The display will show the remaining time.

7. Buzzer will bip for 30 seconds and the timer indicator shows “- -” when the setting time finished.



Using the Timer to switch off one or more cooking zones

1. Touching the heating zone selection control that you want to set the timer for.



2. Touch timer key, “00” will show in the timer display and “0” will blink.



3. Set the time by touching the “+” or “-” controls



4. Touch timer control again, then “0” will flash.



5. Set the time by touching the “+” or “-” controls now the timer you set is 95 minutes.



6. When the time is set, it will begin to count down immediately. The display will show the remaining time.

NOTE: There will be a red dot in the right bottom corner of power level indication which indicating that zone is selected

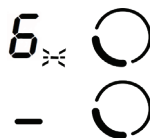

7. When cooking timer expires, the corresponding cooking zone will switch off automatically.

NOTE: Other cooking zones will keep operating if they had been turned on previously.

If the timer is set on more than one zone:

1. When you set the timer for several cooking zones, red dots of the relevant cooking zones are indicated. The timer display shows the min. timer. The dot of the corresponding zone blinks.

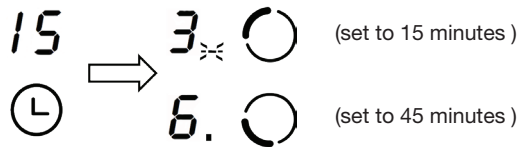

2. Once the countdown timer expires, the corresponding zone will switch off. Then it will show the new min. timer and the dot of corresponding zone will flash.

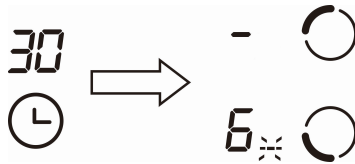

NOTE: Touch the heating zone selection control, the corresponding timer will be shown in the timer indicator.

Cancelling the timer

1. Touching the heating zone selection control that you want to cancel the timer.



2. Touching the timer control, the indicator will flash.



3. Touching “+” or “-” control to set the timer to “00”, the timer is cancelled.

Cooking Guidelines



Take care when frying as the oil and fat heat up very quickly, particularly if you are using Boost. At extremely high temperatures oil and fat will ignite spontaneously and this presents a serious fire risk.

Cooking Tips

- When food comes to the boil, reduce the power setting.
- Using a lid will reduce cooking times and save energy by retaining the heat.
- Minimise the amount of liquid or fat to reduce cooking times.
- Start cooking on a high setting and reduce the setting when the food has heated through.

Simmering, cooking rice

- Simmering occurs below boiling point, at around 85°C, when bubbles are just rising occasionally to the surface of the cooking liquid. It is the key to delicious soups and tender stews because the flavours develop without overcooking the food. You should also cook egg-based and flour thickened sauces below boiling point.
- Some tasks, including cooking rice by the absorption method, may require a setting higher than the lowest setting to ensure the food is cooked properly in the time recommended.

Searing steak

To cook juicy flavoursome steaks:

1. Stand the meat at room temperature for about 20 minutes before cooking.
2. Heat up a heavy-based frying pan.
3. Brush both sides of the steak with oil. Drizzle a small amount of oil into the hot pan and then lower the meat onto the hot pan.
4. Turn the steak only once during cooking. The exact cooking time will depend on the thickness of the steak and how cooked you want it. Times may vary from about 2 – 8 minutes per side. Press the steak to gauge how cooked it is – the firmer it feels the more 'well done' it will be.
5. Leave the steak to rest on a warm plate for a few minutes to allow it to relax and become tender before serving

For stir-frying

1. Choose a compatible flat-based wok or a large frying pan.
2. Have all the ingredients and equipment ready. Stir-frying should be quick. If cooking large quantities, cook the food in several smaller batches.
3. Preheat the pan briefly and add two tablespoons of oil.
4. Cook any meat first, put it aside and keep warm.
5. Stir-fry the vegetables. When they are hot but still crisp, turn the cooking zone to a lower setting, return the meat to the pan and add your sauce.
6. Stir the ingredients gently to make sure they are heated through.
7. Serve immediately.

Heat Settings

NOTE: The below table is a guide ONLY for heat setting selections and could vary based on the power and size of the individual cooking zones. We suggest to use a heat setting initially and increase or decrease settings based on your personal preferences. If this is your first ceramic glass cooktop you may need to experiment a little to get the desired result. The ceramic glass surface will retain heat even after cooking has finished, so take care.

Heat setting	Suitability
1 - 2	<ul style="list-style-type: none">• delicate warming for small amounts of food• melting chocolate (use a double boiler), butter and foods that burn quickly• gentle simmering• slow warming
3 - 4	<ul style="list-style-type: none">• reheating• rapid simmering• cooking rice
5 - 6	<ul style="list-style-type: none">• pancakes
7 - 8	<ul style="list-style-type: none">• sauteing• cooking pasta
9	<ul style="list-style-type: none">• stir-frying• searing• bringing soup to the boil• boiling water

Care and Cleaning



Refer to the SAFETY WARNINGS section at the front of this manual for detailed information regarding safety when cleaning. Cooktop should be powered off before any Maintenance or cleaning is carried out. Use of steam cleaners for cleaning is **not permitted**. The below table is a guide to carry out cleaning of your cooktop.

What?	How?	Important!
Everyday soiling on glass (fingerprints, marks, stains left by food or non-sugary spillovers on the glass)	<ol style="list-style-type: none"> 1. Switch the power to the cooktop off. 2. Apply a cooktop cleaner while the glass is still warm (but not hot!) 3. Rinse and wipe dry with a clean cloth or paper towel. 4. Switch the power to the cooktop back on. 	<ul style="list-style-type: none"> • When the power to the cooktop is switched off, there will be no 'hot surface' indication but the cooking zone may still be hot! Take extreme care. • Heavy-duty scourers, some nylon scourers and harsh/abrasive cleaning agents may scratch the glass. Always read the label to check if your cleaner or scourer is suitable. • Never leave cleaning residue on the cooktop: the glass may become stained.
Boilovers, melts, and hot sugary spills on the glass	<p>Remove these immediately with a fish slice, palette knife or razor blade scraper suitable for ceramic glass cooktops, but beware of hot cooking zone surfaces:</p> <ol style="list-style-type: none"> 1. Switch the power to the cooktop off at the wall. 2. Hold the blade or utensil at a 30° angle and scrape the soiling or spill to a cool area of the cooktop. 3. Clean the soiling or spill up with a dish cloth or paper towel. 4. Follow steps 2 to 4 for 'Everyday soiling on glass' above. 	<ul style="list-style-type: none"> • Remove stains left by melts and sugary food or spillovers as soon as possible. If left to cool on the glass, they may be difficult to remove or even permanently damage the glass surface. • Cut hazard: when the safety cover is retracted, the blade in a scraper is razor-sharp. Use with extreme care and always store safely and out of reach of children.
Spillovers on the touch controls	<ol style="list-style-type: none"> 1. Switch the power to the cooktop off. 2. Soak up the spill 3. Wipe the touch control area with a clean damp sponge or cloth. 4. Wipe the area completely dry with a paper towel. 5. Switch the power to the cooktop back on. 	<ul style="list-style-type: none"> • The cooktop may beep and turn itself off, and the touch controls may not function while there is liquid on them. Make sure you wipe the touch control area dry before turning the cooktop back on.

Note: To keep the ceramic glass surface in good condition a cleaner like Hillmark's Cerapol is recommended. For stubborn stains a scraper should be used to remove excess spills.

Troubleshooting Guide - hints and tips

Refer to the below Troubleshooting Guide should you experience any issues with your cooktop. If these are not helpful please contact our Customer Care team for assistance.

Problem	Possible causes	What to do
The cooktop cannot be turned on.	No power.	Make sure the cooktop is connected to the power supply and that it is switched on. Check whether there is a power outage in your home or area. If you've checked everything and the problem persists, call to book a service call.
The touch controls are unresponsive.	The controls are locked.	Unlock the controls. See section 'Using your ceramic cooktop' for instructions.
The touch controls are difficult to operate.	There may be a slight film of water over the controls or you may be using the tip of your finger when touching the controls.	Make sure the touch control area is dry and use the ball of your finger when touching the controls.
The glass is getting scratched.	Rough-edged cookware. Dragging of cookware across ceramic surface. Unsuitable, abrasive scourer or cleaning products being used.	Use cookware with flat and smooth bases. See 'Choosing the right cookware'. See 'Care and cleaning'.

Technical Specification

Ceramic glass cooktop - 60cm	Model: ICC6GE3
Number of cooking zones	4
Supply voltage	220 - 240V ~ 50 Hz
Connected load	6000 Watts
Product Dimension - D x W x H (mm)	590 x 520 x 50
Cut out Dimensions - A x B (mm)	560 x 490

Ceramic glass cooktop - 90cm	Model: CC96GB
Number of cooking zones	4 (with 2 dual zones)
Supply voltage	220 - 240V ~ 50 Hz
Connected load	6400 Watts
Product Dimension - D x W x H (mm)	900 x 350 x 50
Cut out Dimensions - A x B (mm)	880 x 330

Note: As we continually strive to improve our products we may change specifications and designs without prior notice.

Installation - materials and dimensions

Before you install the cooktop, make sure that

- The work surface is square and level, and no structural members interfere with space requirements. Work surface to be made of heat-resistant material. Work surface material thickness should be at least 30mm thick.
- If the cooktop is installed above an oven, the oven has a built-in cooling fan. Both appliances generate a lot of heat during operation.
- The installation will comply with all clearance requirements and applicable standards and regulations. A minimum of 50mm space shall be preserved around the cutout opening for installation and use of larger cookware.
- A suitable isolating switch providing full disconnection from the mains power supply is incorporated in the permanent wiring, mounted and positioned to comply with the local wiring rules and regulations.
- The isolating switch must be of an approved type and provide a 3mm air gap contact separation in all poles (or in all active [phase] conductors if the local wiring rules allow for this variation of the requirements).
- The isolating switch will be easily accessible to the customer with the cooktop installed
- If any doubts regarding installation requirements you may consult local building authorities and current by-laws.
- Use of heat-resistant and easy-to-clean finishes (such as ceramic tiles) for the wall surfaces surrounding the cooktop is recommended.
- Cut out the work surface according to the sizes shown in table below.

Warning: The work surface material must use the impregnated wood or other insulated material.

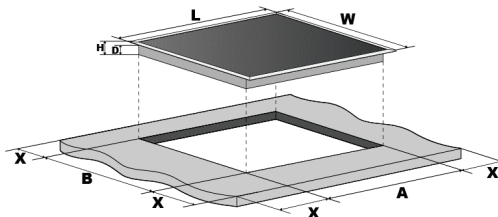

Model No.	L (mm)	W (mm)	H (mm)	D (mm)	A - (mm)	B (mm)	X (mm)
ICC6GE3	590	520	50	46	560	490	50 Min.
CC96GB	900	350	50	46	880	330	50 Min.

Installation - ventilation and clearances



In all circumstances, make sure the cooktop is well ventilated as they do generate a fair amount of heat during use. **DO NOT** install the cooktop if glass is cracked or any other damaged realised.

The safety distance between the cooktop and the cupboard above the cooktop should be at least 760mm. Any rangehood installed above the cooktop should be no less than 650mm above the surface of the cooktop.

NOTE: If the cooktop is installed above an opening drawer or cupboard a thermal protection heat barrier **MUST BE** fitted 50mm below the base of the underside of the cooktop to avoid possibly scalding when accessing the drawer or cupboard.

Refer to the below illustration and table re other ventilation and clearance requirement.

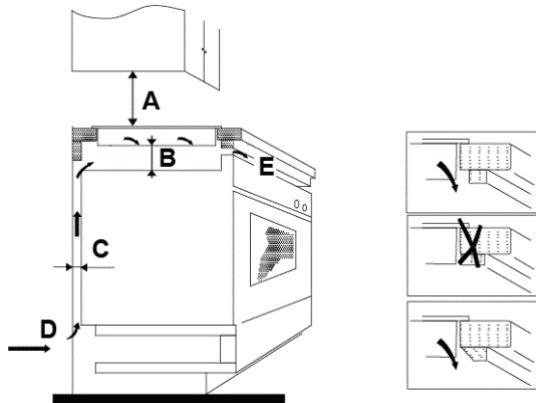

A (mm)	B (mm)	C (mm)	D	E
760 *	50 Min.	20 Min.	Air intake	Air outlet

* This dimension relates to adjoining cupboards. For a rangehood installed above the cooktop the minimum distance is 650mm from cooktop surface highest point to the bottom of the rangehood filters.

After the cooktop has been installed, make sure that

- The power supply cable is not accessible through cupboard doors or drawers.
- There is adequate flow of air from outside the cabinetry to the base of the cooktop.

Installation - fixing cooktop to work surface

Fitting moisture / dirt seal

- The cooktop should be placed on a stable, smooth surface (use the packaging). Fit moisture / dirt seal to underside edge of the cooktop. See below illustration. When cooktop affixed to work surface this seal will reduce risk of moisture and dirt from getting underneath the edge of the ceramic glass surface.

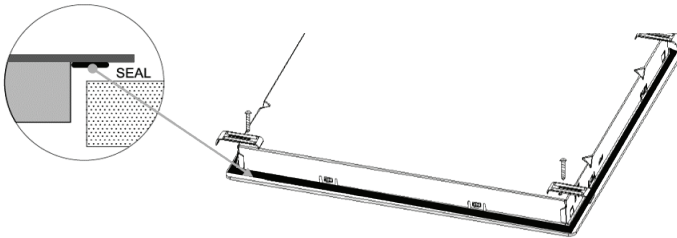

Locating and fitting the fixing brackets and cooktop to work surface

- Whilst the cooktop is upside down the fixing brackets should be put into place
- Fit the fixing brackets to the base of the cooktop in the four corner locations. The brackets can be reversed base on the thickness of the work surface.
- Place cooktop into pre-cut housing in work surface.
- Fix the cooktop to the work surface by screwing the four brackets on the bottom of cooktop (see picture) after installation.

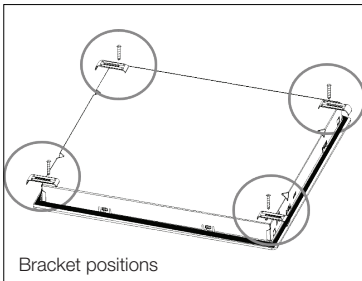

Bracket positions

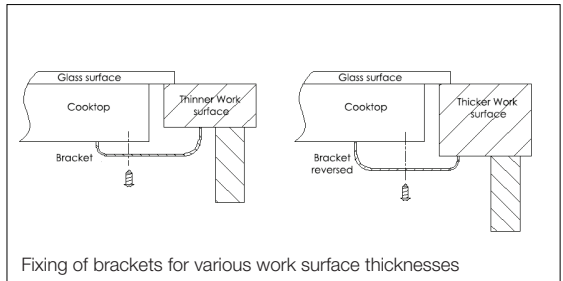

Fixing of brackets for various work surface thicknesses

Installation - electrical connection



The cooktop **MUST BE** installed by qualified personnel or technicians. Please never conduct the operation by yourself.

- The cooktop shall not be mounted close to cooling equipment, dishwashers and rotary dryers. There will be a dedicated power source for the cooktop.
- The cooktop shall be installed with sufficient ventilation to ensure its reliability.
- The wall, work surface, adjoining cupboards, doors and adhesives shall be able to withstand high heat generated by the cooktop.
- For cleaning, steam cleaners are not to be used.
- This ceramic cooktop can be connected only to a supply with system impedance no more than 0.427 ohm. In case necessary, please consult your supply authority for system impedance information.
- The cable must not be bent or compressed. If the cable is damaged or needs replacing, this should be done only by a qualified after-sales technician. Regular checks on the cable by a qualified technician is recommended.
- If the appliance is being connected directly to the mains supply, an omnipolar circuit breaker must be installed with a minimum gap of 3mm between the contacts.
- The installer must ensure that the correct electrical connection has been made and that it complies with safety regulations.

Connecting the cooktop to the mains power supply

The power supply should be connected in compliance with the relevant local standards to a single-pole circuit breaker. The method of connection is shown below.

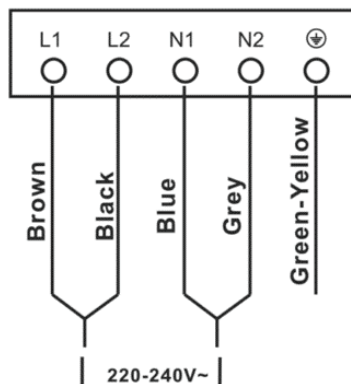



DISPOSAL: Do not dispose this product as unsorted municipal waste. Collection of such waste separately for special treatment is necessary.

This appliance is labeled in compliance with European directive 2002/96/EC for Waste Electrical and Electronic Equipment (WEEE). By ensuring that this appliance is disposed of correctly, you will help prevent any possible damage to the environment and to human health, which might otherwise be caused if it were disposed of in the wrong way.

The symbol on the product indicates that it may not be treated as normal household waste. It should be taken to a collection point for the recycling of electrical and electronic goods.

This appliance requires specialist waste disposal. For further information regarding the treatment, recover and recycling of this product please contact your local council, your household waste disposal service, or the shop where you purchased it.

For more detailed information about treatment, recovery and recycling of this product, please contact your local city office, your household waste disposal service or the shop where you purchased the product.