



“ROTANTE” pizza oven



Manufacturer:

Univex Corporation: 3 Old Rockingham Road, Salem NH 03079

Phone: 603-893-6191

Website: www.univexcorp.com

USER MANUAL AND MAINTENANCE GUIDE

This user manual is part of the machine and should be kept in proper condition in order to maintain its integrity and to allow for consultation during the equipment's life cycle.

DOME47RT	DOME 59RT
DOME47FT	DOME 59FT

WARNING: Read the instructions before using the equipment.

**REVIEW CAREFULLY THIS MANUAL BEFORE
CARRYING OUT ANY OPERATION ON THE EQUIPMENT**





“ROTANTE” pizza oven

The manufacturer has the right to make changes to the production model and manual without the obligation to update previous production models and manuals.

Please read this entire manual before installing the oven. Failure to follow instructions may result in property damage, bodily injury or even death. Contact your local building or fire officials about restrictions and installation inspections in your area.

FOR YOUR SAFETY

Do not store or use gasoline or other flammable vapour or liquids in the vicinity of this or any other appliance.

Also, always keep the area under and around this appliance free and clear of any and all combustible materials. Do not obstruct the flow of combustion and ventilation air.

DO NOT THROW THIS MANUAL AWAY

RETAIN THIS MANUAL FOR FUTURE REFERENCE.
ADDITIONAL COPIES AVAILABLE UPON REQUEST.

IMPORTANT: Consult your local gas supplier for a statement outlining a procedure to be followed in the event you smell gas. Post the statement in a prominent location.

⚠ WARNING: Improper installation, adjustment alteration, service or maintenance can result in property damage, injury or death. Read the installation, operation and maintenance instructions thoroughly before installing or servicing this equipment

It is recommended that this oven be installed, maintained and serviced by authorised professionals.

Additional copies of this manual and prompt responses to service / maintenance questions are available from Univex.



“ROTANTE” pizza oven

Table of Contents

1. GENERAL NOTICE	4
1.1 Test and warranty	4
1.2 Client's responsibilities.....	4
1.3 Equipment safety	5
2. GENERAL INFORMATION.....	6
2.1 Definitions and icons.....	6
2.1.1 Definitions.....	6
2.1.2 Icons.....	7
3. MANUFACTURER'S NAME AND ADDRESS.....	9
3.1 Information on technical support and maintenance	10
4. TECHNICAL INFORMATION AND SPECIFICATIONS	11
5. GENERAL DESCRIPTION	13
6. INSTALLATION AND STORAGE	14
6.1 Inspections upon receipt of the equipment	14
6.2 Storage	14
7. ASSEMBLING INSTRUCTIONS.....	15
7.1 Clearances	15
7.2 Positioning of the oven	16
7.3 Electrical connection.....	18
7.4 Hydraulic connection	19
7.4.1 Gas conversions	21
8. USING THE OVEN	25
8.1 Equipment's functions and controls	25
8.2 First startup of the oven	27
8.3 Normal operation	29
8.3.1 Manual operating mode.....	30
8.3.2 Automatic operating mode.....	31
8.3.3 Sheated element control and setup	31
8.3.4 “BAKING 1” and “BAKING 2” programs.....	33
8.4 Program complete.	34
9. Setting parameters for the oven's general configuration.....	35
10. MAINTENANCE	37
10.1 Daily maintenance	37
10.2 Periodic maintenance	37
11. INCONVENIENCES AND ANOMALIES	39
12. INTERVENTION REQUEST FORM - REPLACEMENT PARTS.....	41
13. REPLACEMENT PART LIST	42
14. ATTACHMENT LIST	42
15. WARRANTY	43



“ROTANTE” pizza oven

1. GENERAL NOTICE

1.1 Test and warranty

The oven and its components have already been tested at our plant in compliance with the applicable regulations and laws, and are delivered ready for use.

Any attempt to disassemble, change or, in general, tamper with any part of the equipment will invalidate the warranty.

Any improper use of the oven, as well as any attempt to disassemble and modify the oven, can lead to accidents and therefore Univex declines any responsibility for potential injuries or damages resulting from tampering. In case of anomalies, please consult your local authorized customer service center and, more specifically, contact directly the manufacturer for help with assembling, installing or moving the equipment. The manufacturer shall be relieved from any responsibility in the following cases:

- Improper use of the equipment by inadequately trained personnel.
- Installations that are not compliant with applicable laws in the country of use and performed by non-authorized personnel.
- Scheduled routine maintenance that was not carried out or that was performed incorrectly.
- Use of non-original or non-approved replacement parts.
- Partial or total non-observance of the instructions.

The warranty is effective as per 12 months since the delivery date and covers the replacement or repair of any faulty part, except for electric or electronic components and parts. The manufacturer should be notified of any visible defect or anomaly within 5 days since the date of receipt to be able to conduct an inspection.

Any other defect that might be seen upon receipt of the oven should be notified within 5 days since it was noticed and in any case within maximum 6 months.

The buyer has the right to request the repair or replacement of the faulty parts only, since the warranty does not cover in any way the damages related to any other direct or indirect cause.

The repair and replacement of faulty parts should be requested within the maximum limit as outlined in the warranty unless otherwise specified by law.

Damaged or faulty parts will be repaired or replaced by the manufacturer. The buyer is therefore responsible for sending free of carriage charges the above-mentioned parts to the manufacturer, who will resend them to the buyer.

1.2 Client's responsibilities

The client should be held responsible for the following:

- Reading thoroughly this user manual before installing and using the equipment
- Installing and positioning correctly the oven as per instructions outlined in chapter 6 of this manual
- Observing the applicable regulations and laws for gas interconnection or use of solid fuels
- Connecting and implementing the fume extraction system / Connecting the flue pipe
- Cleaning and care of the oven
- Routine maintenance

1.3 Equipment safety

- Please read carefully this booklet and its safety guidelines on use and maintenance. This manual's aim is to share key rules and criteria with the operators in order to guarantee their safety and extend the oven's operating time. This manual shall be read and understood by all members of the personnel who have been authorized to operate on the oven before its first startup.
- This instructions booklet must be stored together with the equipment for future reference. In case you want to sell or transfer the equipment, make sure to include this booklet so that the new user can be informed about the operating instructions and related warnings. It must be stored in a safe and dry place, and should be easily accessible for consultation. In case it falls apart or gets lost, you can request a copy directly to the manufacturer; in case of doubt, please consult your local customer support center or contact directly Univex.
- This equipment is designed for baking pizzas. It should not be used for any other purpose; any other use is to be considered inappropriate.
- Maintenance, adaptation to another type of gas, startup and functional checks should be carried out only by qualified personnel.
- We recommend you to subscribe a servicing agreement with your supplier.
- Please contact an authorized technical support center to repair and request original spare parts.
- The equipment is designed for commercial use and should be used by trained personnel.
- This type of equipment is designed for use in commercial applications, such as restaurants, cafeterias, hospitals and commercial businesses, like bakeries, butcheries, etc., but it is not designed for the continuous production of food.
- The manufacturer declines any responsibility for potential damages due to non-observance of the instructions for use and maintenance, or due to inappropriate use of the equipment.

2. GENERAL INFORMATION

This user manual is part of the standard-production equipment and represents a fundamental support for its startup and appropriate use.

Read it carefully and thoroughly before installing and using the equipment.







In case of reselling, the manual shall be included as part of the equipment.

Partial reproduction of this document without the written authorization by Univex is forbidden.

2.1 Definitions and icons

Here below we illustrate a series of definitions, specific terminology and icons that have been used in this manual.

2.1.1 Definitions

Icon	Description
	Lifting and Handling Equipment Operator: the operator who has been trained to use equipments for lifting and handling materials and machines. Handling operations should be carried out according to the instructions described in this manual and in compliance with the applicable laws in the country where the equipment is used.
	First Level Operator: the operator, with no specific skills, who is able to use the equipment in normal working condition and for simple maintenance interventions.
	Mechanical Maintenance Technician: the qualified technician who has been trained to operate the equipment in normal working condition and to operate on mechanical - hydraulic - pneumatic gears in order to make adjustments, maintenance interventions, installations or repairs according to the instructions outlined in this manual.
	Electrical Maintenance Technician: the qualified technician who has been trained to carry out interventions on live electrical racks, branching boxes and electrical fittings, as well as to operate the equipment under normal working conditions and to make interventions on electrical systems for adjusting, maintenance, installation and repair operations.
	Manufacturer's Technician: the qualified technician who has been designated by the manufacturer to carry out complex operations in specific situations or, in any case, on the basis of what has been agreed upon with the user. Depending on each case, the personnel is requested to have mechanical and/or electrical and/or electronic and/or IT skills.
	Equipotential bonding
	Ground protection

2.1.2 Icons



NOTE

Shows guidelines or key information described in the user manual, that should be read carefully, for the most appropriate use of the equipment.



DANGER

Warns against the risk of injuries, included lethal accidents, or serious health damages.



CAUTION

Indicates a situation that could, even indirectly, be harmful for persons, things and the environment with consequences of economic losses.





WARNING



Indicates that you should pay special attention to the instructions. Non-observance of such warnings could lead to malfunctions or dangerous conditions or damages.

HAZARD PICTOGRAMS

Warning signs (Warning, Caution, Check)

	High voltage danger	
	Hot surface	
	Moving gears danger	

Prohibition signs (Dangerous behaviors, Danger, Make-and-Break, Emergency device)

	Prohibition to use water to extinguish fires	
	Prohibition to clean, oil, grease, repair or adjust moving gears by hand	

Mandatory signs (specific action or behavior, obligation to wear a personal safety device)

	Mandatory protective gloves	
---	-----------------------------	--



“ROTANTE” pizza oven

3. MANUFACTURER'S NAME AND ADDRESS

This product has been manufactured by:

Forni Ceko Srl
Via industriale 21/23
25030 Lograto (BS) ITALY
Tel 030.9972249 FAX 030.9972818
ceky@ceky.it www.ceky.it

The plate on the oven front face includes all the identification data related to the oven itself.

Figure 3.1 shows a sample plate that is applied to the frontal face of the oven, near the connection box: the information shown is exclusively indicative.

Fig.3.1 Sample plate

ceky
Forni Ceko SRL
via industriale, 21/23
25030 Lograto (BS) Italy
ANS Z 83.11 • CSA 1.8-2016 Food Service Equip Master contract: 248684

MODEL / MODÈLE:
SERIAL NUMBER / NUMÉRO DE SÉRIE:
ELECTRICAL RATING / PUISSANCE ÉLECTRIQUE: 6500W 16A - 50/60Hz - 120/208VAC~
3 PHASES 4 CONDUCTOR

	Natural gas Gaz naturel	LP gas Gaz de pétrole liquéfié
Manifold pressure / Pression d'arrivée (i.w.c.)	4	10
Burner rate / Débit du brûleur (Btu/h):	92500	92500

For natural gas when equipped with No. 5.10 mm drill size orifices
For LP gas when equipped with No.2.80 mm drill size orifices

For your safety refer to installation instruction for conversion procedure
Intended for other than household use
Minimum dimension of combustion openings: 15 square inches
Not suitable for connection to Type B Gas Vent

Pour l'utilisation de gaz naturel lorsque l'appareil est pourvu d'un orifice n° 5.10 mm
Pour l'utilisation de gaz de pétrole liquéfié lorsque l'appareil est pourvu d'un orifice n°
2.80 mm

Pour la conversion sécuritaire de l'appareil, se reporter aux instructions d'installation.
Non destiné à l'usage domestique
Dimension minimale des orifices de combustion : 15 pouces carrés
Ne convient pas au raccordement à un conduit d'évacuation de type B.



It is absolutely forbidden to remove or tamper with the plate; in case of accidental damage, please contact the manufacturer to request a copy.

3.1 Information on technical support and maintenance

In case of failures or malfunctions, please contact our Customer Support Center:

[Univex Corporation](#)
[603-893-6191](#)
Service@Univexcorp.com

For communications or requests of information or replacement parts, please send the "REPLACEMENT PART ORDERING, FAULT REPORTING, INFORMATION" form in the Attachment 1 to our customer support center.



To be covered for the entire duration of the warranty period, the buyer should follow strictly the instructions outlined in this manual. In case of non-observance, Univex is relieved from any responsibility for inconveniences or anomalies or damages to the equipment or to third parties.



In order to adapt the equipment to technological advances and to specific needs at production level, the manufacturer can decide, without prior notice, to make any change on the equipment without the obligation to update previous production models and manuals.

Furthermore, although the illustrations shown in this manual are slightly different from the equipment you own, its safety and operating instructions are always guaranteed.



“ROTANTE” pizza oven

4. TECHNICAL INFORMATION AND SPECIFICATIONS

Table 4.1.

DOME47RT/ DOME47FT						
Natural gas	Total Input Rate (Btu/hr)			92500		
	N. of burners and input rate (Btu/hr)			1 x 92500		
	Manifold pressure (iwc)			4		
	Nozzle orifices 1/100mm			510		
	Air adjustment mm			8		
LP Gas	Total Input Rate (Btu/hr)			92500		
	N. of burners and input rate (Btu/hr)			1 x 92500		
	Manifold pressure (iwc)			10		
	Nozzle orifices 1/100mm			280		
	Air adjustment mm			Open		
DOME59RT/DOME59FT						
Natural gas	Total Input Rate (Btu/hr)			97500		
	N. of burners and input rate (Btu/hr)			1 x 97500		
	Manifold pressure (iwc)			4		
	Nozzle orifices 1/100mm			540		
	Air adjustment mm			8		
LP Gas	Total Input Rate (Btu/hr)			97500		
	N. of burners and input rate (Btu/hr)			1 x 97500		
	Manifold pressure (iwc)			10		
	Nozzle orifices 1/100mm			290		
	Air adjustment mm			Open		
Models	Production (hourly) ¹	Burner power Btu	Rated power in KW	Internal chamber Diameter cm/inches	Deck diameter cm/inches	Weight Kg/Lb
DOME47RT DOME47FT	100	92500	6,5	120cm 47,24"	100cm 39,37"	2000Kg 4409Lb
DOME59RT DOME59FT	180	97500	6,5	150cm 59"	140cm 55,11"	2500Kg 5511Lb

¹ Data refer to pizzas with a diameter of 30 cm avg. cooking time of 2.30 minutes



Drawing		Details	
	DOME47RT	DOME 59RT	
	Height H 185cm 72,83” Length L 165cm 65”	Height H 185cm 72,83” Length L 195cm 76,77”	
	External diameter 165cm 65”	External diameter 195cm 76,8”	
	DOME47FT	DOME59FT	
	Height H 185cm 72,83” Length L 205cm 80,7”	Height H 185cm 72,83” Length L 235cm 92,5”	
	Depth D 165cm 65”	Depth D 195cm 76,77”	

5. GENERAL DESCRIPTION

The Rotating model is characterized by an innovative baking technology which is based on an independent dual heating system (chamber gas burner and electric bedplate) and a variable speed rotating bedplate or deck.

The highly efficient baking chamber, which is made of high-quality refractory materials, combined with a smart control of the burner flame and the rotating deck, helps the oven deliver excellent performance with high levels of hourly production.



The oven should be used exclusively for baking pizzas and solid foodstuff for human consumption. It should not be used with liquid or gas products, containers or packages that have been hermetically sealed.



This type of equipment is designed for use in commercial applications, such as restaurants, cafeterias, hospitals and commercial businesses, like bakeries, butcheries, etc., but it is not designed for the continuous production of food.



As regards airborne noise emissions, the weighted sound pressure level A is lower than 70 dB(A)

6. INSTALLATION AND STORAGE

6.1 Inspections upon receipt of the equipment



Lifting and Handling Equipment Driver: the operator who has been trained to use equipments for lifting and handling materials and machines (paying special attention to the instructions provided by the manufacturer), in compliance with the applicable laws in the country where the machine is used.



For handling, loading and unloading operations, please use a pallet carrier (e.g. a forklift truck) with a minimum loading capacity of 4,000 kg and with long forks. Arrange the pallet on a surface where there's enough space for unpacking operations.

Remove the packing and make sure the content is intact.



Oven's metal standing support



In case of damage or missing elements or in case you see defects or damages, please do not try to repair the equipment, but instead contact our customer support center indicating the equipment's model, code and serial number (see Fig. 3.1 Sample plate).

6.2 Storage



In case the equipment is not used for a long period of time, please protect the equipment from dust and humidity. Remove the air bubble packing to allow for an adequate ventilation and to prevent the formation of condensed steam inside the oven.

7. ASSEMBLING INSTRUCTIONS

7.1 Clearances

⚠️ WARNING:  **If this oven is not properly installed a fire may result.**

To reduce the risk of fire, follow this installation instructions. A major cause of oven related fire is failure to maintain required clearances (air spaces) to combustible materials. It is of utmost importance that this oven be installed only in accordance with these instructions.

Please read this entire manual before you install the oven. Failure to follow instructions may result in property damage bodily injury or even death. Contact your local building or fire officials about restrictions and installation inspection in your area.

CLEARANCES

- I) The Univex oven must have a minimum 1" clearance to combustibles from all size and 16" from combustibles from the top.
If building a facade that will contact the oven, use completely non-combustible materials (when non-combustible building materials contact the body of the oven, the clearances to combustibles are transferred to those non combustibles). Please note that standard dry-wall (or sheet rock) is considered a combustible.
- II) Any facade above and/or 6 inches to either side of the oven doorway, must be constructed of non combustible building materials
- III) Install this oven only on non combustible floors. The non combustible floor surface should extend 40 inches out in front of the oven and extend 32 inches to either side of the oven doorway.
- IV) Leave a clearance of at least 200cm² under the oven
- V) Leave a clearance for servicing and proper operation in case you are covering the iron stand

⚠️ WARNING: installation and servicing of this product could expose you to glass wool/ceramic fibres and dust.

ALWAYS WEAR RESPIRATORY AND EYE PROTECTION WHEN INSTALLING OR SERVICING THIS APPLIANCE

7.2 Positioning of the oven



Lifting and Handling Equipment Operator: the operator who has been trained to use equipments for lifting and handling materials and machines. Handling operations should be carried out according to the instructions described in this manual and in compliance with the applicable laws in the country where the equipment is used.





The equipment should be installed in a well-ventilated place, and possibly located under a smoke extraction panel in order to ensure the complete evacuation of exhaust gases, or directly connected to the flue pipe according to the construction type. The flue outlets for combustion smoke should be sized and engineered according to the applicable provisions.

Make sure that the air inflow needed for combustion is guaranteed by a minimum surface of 5,4 ft² (oven's lower area) and with an adequate air recirculation in the upper area through a minimum aeration zone of one squared meter.



The oven should be positioned in such a way that it can be accessed during maintenance interventions. Once it has been positioned, please check the vent outlets. The combustion air amount for a correct combustion is 1907 ft³/h for 47 serie, while it's 2013 ft³/h for 59 serie. Minimum distances to be kept between the equipment and adjacent walls should not be less than 1 inch on each side.

The figures below show the assembling operations to mount the oven's standing support and then to position the oven.

	
<p>The oven's standing support is made of 4 metal tubular elements that are respectively made of two sides with four verticals, a rear part and a front part. Arrange the standing support in the desired area and assemble the various parts as illustrated.</p>	<p>Position the rear support on the sides, align the 4 holes and connect the parts with nut and bolt including the washers on both sides. Repeat the operation for the front support (n. 2 holes)</p>

“ROTANTE” pizza oven



Tighten firmly all the parts of the standing support.

Once the standing support has been mounted, position the structure in the area where the oven will be installed.
The red panel shows the side where the oven's door will be positioned.

Load the oven's body inserting the forks as shown in the figure (see green rectangles, close to the oven's standing feet).



The incorrect positioning of the forks can severely damage the equipment.

DO NOT insert the forks in the area marked as red in the figure above.



After reaching the installation position, lift the oven up to a working height for the correct positioning on the standing support.

Align the standing support's verticals under the oven's standing feet with simple manual operations.

Lower the oven till it lays completely on the standing support's verticals.

7.3 Electrical connection



The correct functioning and the observance of safety requirements are guaranteed only if the equipment is connected to an efficient electrical system that is installed according to the applicable laws. Univex does not take any responsibility for any damage to the equipment or to third parties that is caused by the use of an electrical system that is not compliant with the applicable laws.



electrical and grounding connections must comply with the applicable portions of the national electrical code and/or other local electrical codes.

disconnect electrical power supply and place a tag at the disconnect switch to indicate you are working on the circuit.

appliances equipped with a connection box suitable for connection to a ½” conduit.



Electrical Maintenance Technician: the qualified technician who has been trained to carry out interventions on live electrical racks, branching boxes and electrical fittings, as well as to operate the equipment under normal working conditions and to make interventions on electrical systems for adjusting, maintenance, installation and repair operations.

Fig.7.1 Wiring scheme – Printed copy inside connection box

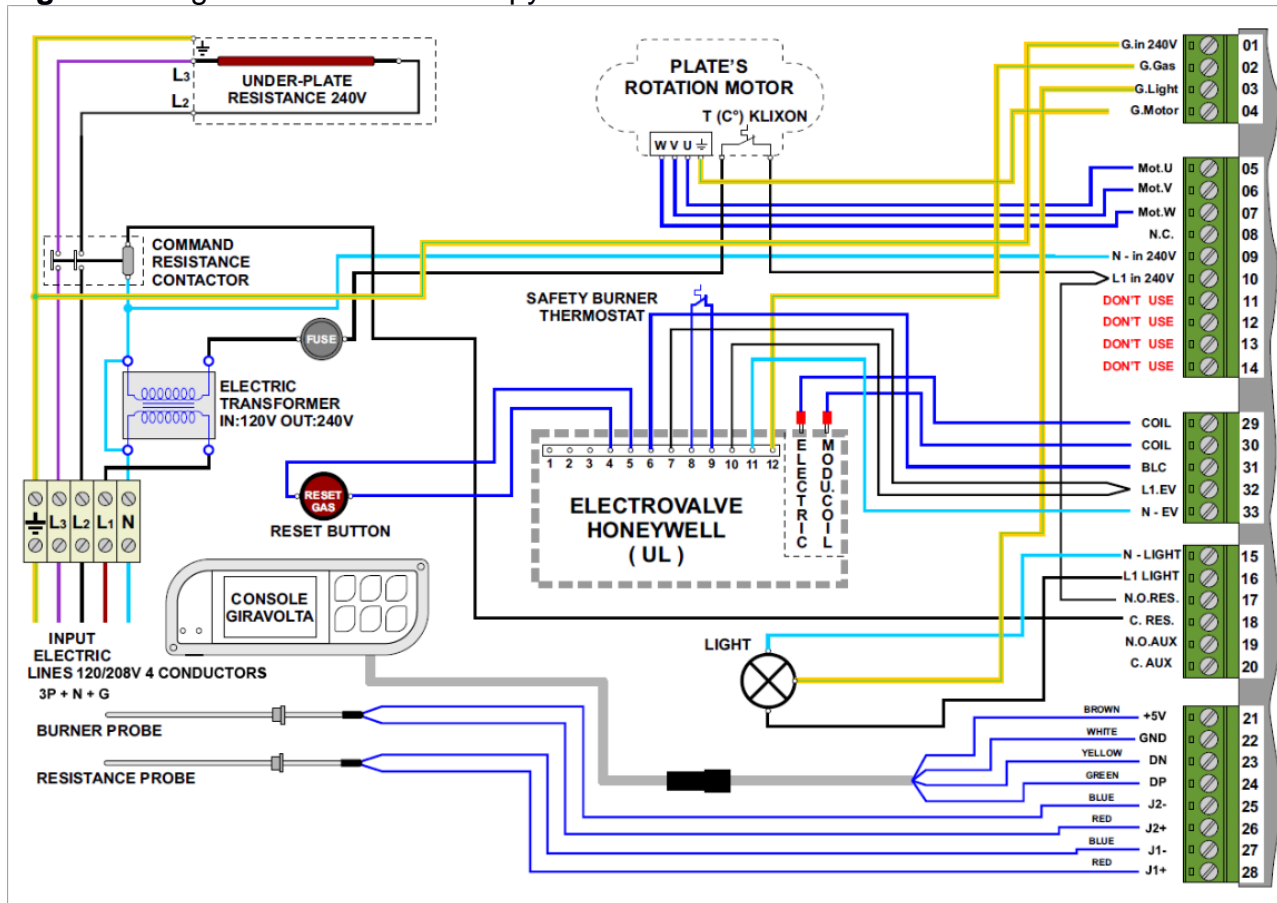

It is the electrician's responsibility to size and install the oven's supply cable to the mains system according to the oven's electrical specifications (see data on the plate).



All wiring should conform the Local codes and NEC.

The appliance must be electrically grounded in accordance with the local codes, or in absence of local codes, with the National Electrical Code NFPA 70, or the Canadian Electrical Code, CSA C22.2, as applicable.

The oven is equipped with a connection box, with terminal block inside, located on front, right side, pre-drilled to receive a 1/2" conduit.

Install the conduit and proceed driving a proper branch circuit wire in the conduit from the electrical panel to the connection box.

Loosen the upper screws of the field wire terminal.

Insert the bare wire ends in the field wire terminal openings according to the scheme (fig 7.1) and tighten the screws securely.

NOTE: Electrical diagrams are located inside the connection box, shown below

Fig 7.1.1 Connection Box Highlighted view

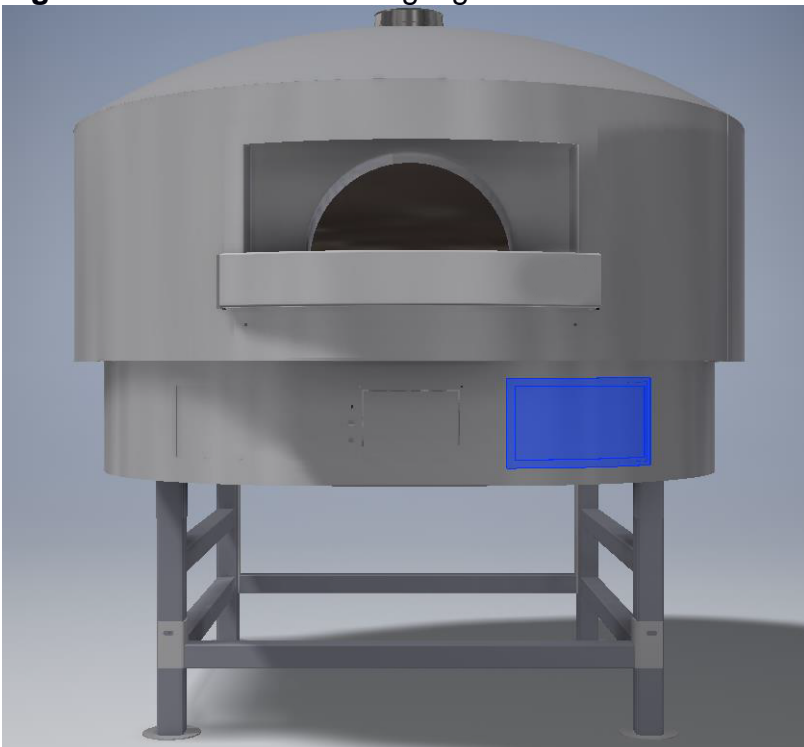

7.3.1 Electrical specifications

Voltage	240/120 4W
Frequency	50-60Hz
Amp	16

7.4 Hydraulic connection



Mechanical Maintenance Technician: the qualified technician who has been trained to operate the equipment in normal working condition and to operate on mechanical - hydraulic - pneumatic gears in order to make adjustments, maintenance interventions or repairs according to the instructions outlined in this manual.

NOTE: INSTALLATION MUST CONFORM WITH LOCAL CODES, OR IN THE ABSENCE OF LOCAL CODES, WITH THE NATIONAL FUEL GAS CODE, ANSI Z223.1/NFPA 54, OR THE NATURAL GAS AND PROPANE INSTALLATION CODE, CSA B149.1, AS APPLICABLE, INCLUDING:

1. The appliance and its individual shutoff valve must be disconnected from the gas supply piping system during any pressure testing of that system at test pressures in excess of 1/2 psi (3.5 kPa).
2. The appliance must be isolated from the gas supply piping system by closing its individual manual shutoff valve during any pressure testing of the gas supply piping system at test pressure equal to or less than 1/2 psi (3.5 kPa).

Connect the equipment to the gas distribution system with pipes and accessories to the oven's input valve (standard coupling 1/2”).



Before turning on the burner:

- Check that the gas pressure entering the electrovalve is not higher than the rated value.
- Verify that the connecting tubes are tightly sealed.
- Install a gas flow stop cock near the oven for possible emergency operations and for a better regular management of the oven.
- Check the compatibility of the available fuel with the type of nozzles mounted on the burner.

The type of nozzles, the fuel and the maximum operating pressure are indicated in the plate on the oven. The flame minimum is factory adjusted. Univex accepts no responsibility for any damage caused to the equipment or to third parties as a result of an incorrect installation.

Fig 7.2 Nozzle-holder curve and damper sleeve

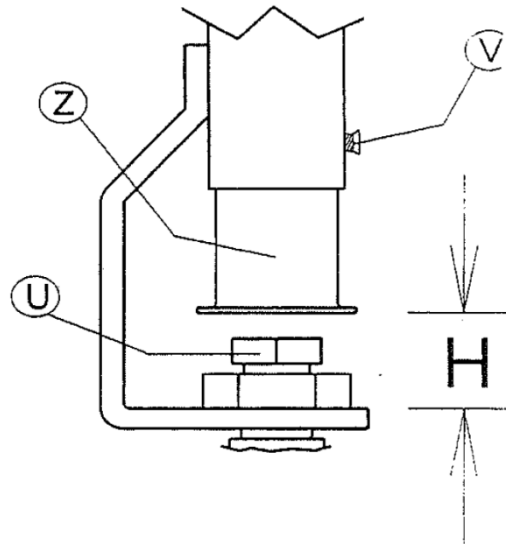

7.4.1 Gas conversions

Gas conversions from Natural Gas to LP gas or from LP gas to Natural gas must be done by a qualified installer.

Converting Gas pressure regulator

1. Turn manual shutoff valve to the “closed” position.
2. Unplug range or disconnect power.

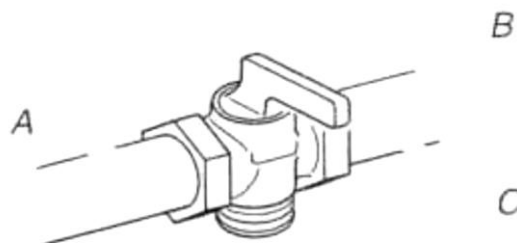

- A. To range
 B. Manual shutoff valve “closed” position
 C. Gas supply line

3. Remove the access cap by using a wrench, turning the access cap anticlockwise.

4. Remove spring retainer from the cap by pushing against the flat side of the spring retainer. Look at the spring retainer to locate the “NAT” or “LP” position.
5. Turn over the spring retainer so the “LP” is showing on the bottom.
6. Snap the spring retainer back into the cap.
7. Reinstall the cap onto the regulator.

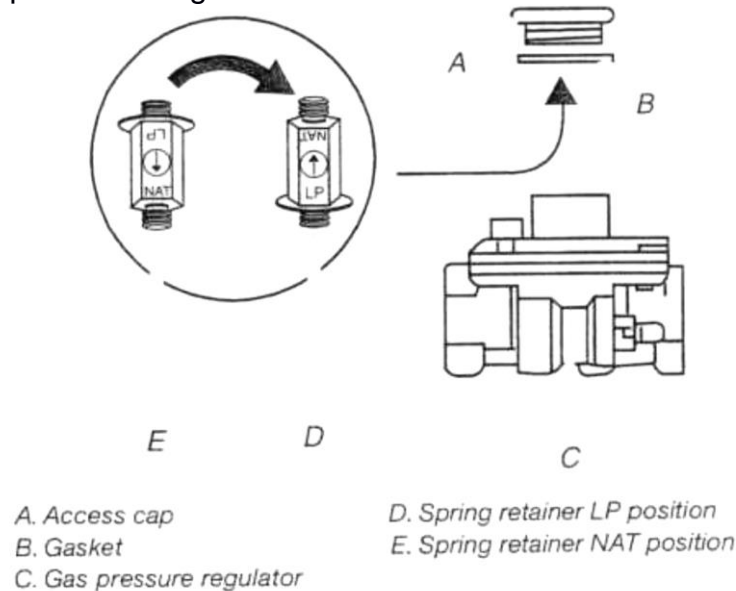

8. With a nut driver remove the gas nozzle “U” by turning it anticlockwise and lifting out. Set gas nozzle aside. Fig 7.2
9. Gas nozzles are stamped with a number on the side. The number represents the size of the orifice in mm

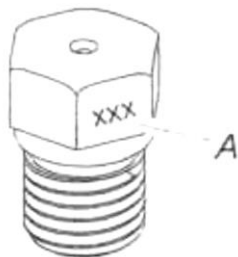

A. Stamped number

10. Place the replaced nozzle in a plastic bag for future use and keep it with literature package.
11. Loosen the V screw.
12. Shift the Z sleeve.
13. Adjust the Z sleeve to the distance H corresponding to the new installation (refer to pag.11 for regulation values) and tighten the V screw.
14. Complete installation

Setting minimum / maximum gas levels

The maximum pressure setting must first be adjusted to ensure that burner will safely light up, then the minimum pressure setting can be adjusted. Any adjustment of maximum pressure setting influences minimum pressure setting, thus a minimum pressure setting should always be re-adjusted after changing maximum value.

		Maximum	Minimum
Natural gas	iwc (kPa)	3,55 (0,88)	0,4 (0,1)
LP gas	iwc (kPa)	9,7 (2,4)	1 (0,5)

Adjusting the maximum pressure setting (see fig 7.3.)

Method 1:

- Disconnect pressure feedback connection (if applicable).
- Connect a suitable pressure gauge to pipe line or to outlet pressure tap of gas control concerned, to measure burner pressure (measuring point must be as near to burner as possible).
- Disconnect electrical connection of Moduplus®.
- Energize operator, set control in operation and wait until an outlet pressure is recorded on pressure gauge.
- Push shaft gently downwards by means of a suitable pin through the hole on the top of the Moduplus® to the bottom and hold it on.
- If maximum rate pressure needs adjustment then use an 8 mm wrench to turn adjustment screw for maximum pressure setting clockwise to increase or counterclockwise to decrease pressure, until the desired maximum outlet pressure is obtained. Release shaft.
- Check minimum pressure setting and readjust if necessary. (according instructions below)
- Mount cap and reconnect pressure feedback connection (if applicable).
- If minimum and maximum pressures are set, wire the Moduplus® in circuit.
- Close pressure tap screw

Method 2:

- Disconnect pressure feedback connection (if applicable).
- Connect a suitable pressure gauge to pipe line or to outlet pressure tap of gas control concerned, to measure burner pressure (measuring point must be as near to burner as possible).
- Make sure that the appliance is in operation and the Moduplus® coil is energized with maximum current.
- If maximum rate pressure needs adjustment then use an 8 mm wrench to turn adjustment screw for maximum pressure setting clockwise to increase or counterclockwise to decrease pressure, until the desired maximum outlet pressure is obtained.
- Disconnect electrical connection of Moduplus®
- Check minimum pressure setting and readjust if necessary. (according instructions below)
- Mount cap and reconnect pressure feedback connection (if applicable).

- If minimum and maximum pressures are set, wire the Moduplus® in circuit. • Close pressure tap screw

Adjusting minimum pressure setting (see fig. 7.3.)

- Disconnect pressure feedback connection (if applicable).
- Connect a suitable pressure gauge to pipe line or to outlet pressure tap of gas control concerned, to measure burner pressure (measuring point must be as near to burner as possible).
- Disconnect electrical connection of Moduplus®.
- Energize operator, set control in operation and wait until an outlet pressure is recorded on pressure gauge.
- If minimum rate pressure needs adjustment then use a 5 mm wrench to turn adjustment screw for minimum pressure setting clockwise to increase or counterclockwise to decrease pressure, until the desired minimum outlet pressure is obtained.
- Check if main burner lights easily and reliable at minimum pressure.
- Mount cap and reconnect pressure feedback connection (if applicable).
- Close pressure tap screw

Maintenance

It is recommended to check yearly the minimum and the maximum setting and readjust them if necessary.

- A Cap
- B Adjustment screw (5 mm) for minimum pressure setting
- C Adjustment screw (8 mm) for maximum pressure setting
- D 2.8 mm AMP terminals
- E Pressure feedback connection

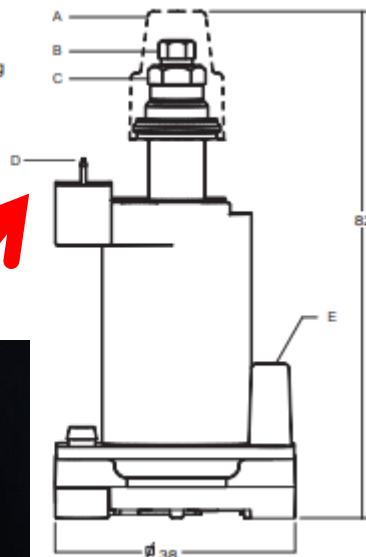

Fig 7.3

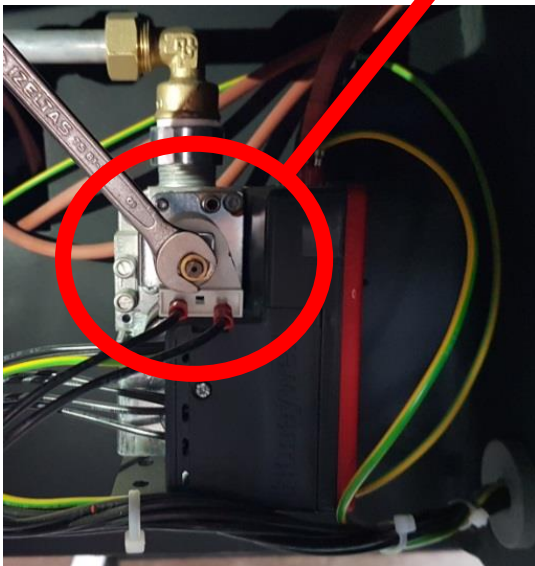

Fig 7.4
Frontal view of the valve

8. USING THE OVEN

Once the installation has been successfully completed, the oven is ready to be operated.



CAUTION

When using the oven, please pay attention to the hot steam coming from the oven's front opening (the oven's door).

8.1 Equipment's functions and controls

For ease of reference, hereinafter we will use some abbreviations/definitions whose functions are described here below.

	Abbreviation	Type of action or function
Instant key action	PI	The operator should press and momentarily hold the selected key to activate the associated control.
Retained key action	PM	The operator should press and hold for 2 seconds the selected key to activate the associated control.
Baking program	PC	Baking cycle. The process is regulated through a series of stored parameters (burner flame level, engine rotation speed and baking time).
Status and operating conditions of the oven	First startup	Oven's status configuration after installation completion, and each time the mains voltage is lost and restored.
	Standby	Status preceding the product's baking phase.
	Baking	Operating conditions of the oven when baking the product. Two cycles can be selected: “BAKING 1” or “BAKING 2”. The baking process is regulated with user-customized level values for the burner's flame, duration and deck's rotation speed.
Page		Program The oven's operating mode at the end of the complete “BAKING 1” or “BAKING 2” cycle. Graphic image on the display showing information on the oven's operating status and operator's controls.
Graphic key on the display		Operator's control activated by touching the figure (icon) proposed in the various pages shown on the display.
TOUCH key on the lateral keyboard	TOUCH function	Operator's control by simply pressing (touching lightly) the drawing of the associated key with a finger.

Baking cycle

Customized baking process selected through the TOUCH function keys:



“BAKING 1” or



“BAKING 2”

Fig. 8.1.1. Operator Interface Panel

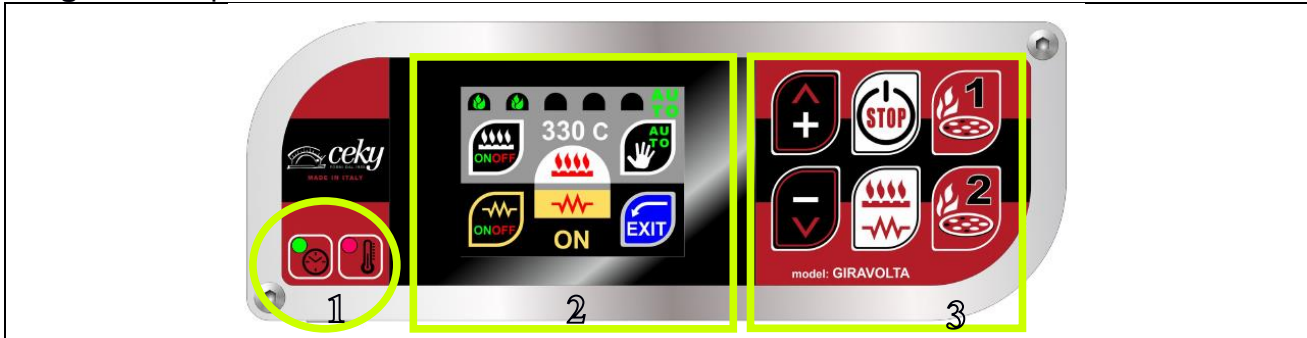

All settings and operating information of the oven are available in the operator panel and include:

- 1. LED signal lights. They notify the operator on the oven's operating status.
- 2. Display touch screen. Device with a graphic interface that allows the user to see the oven's operating conditions and to interact with its operation through the use of the graphic keys proposed by the display (operation is activated by touching lightly the graphic).
- 3. TOUCH function keys (rapid function). Activates some specific working functions of the oven.

Fig. 8.1.2. LED signal lights in two colors (red or green)

Icon	Signal status	Description	
	Solid red	Electronics OFF, sheated element, baking deck rotation and burner OFF (only the mains supply tension is ON);	
	Flashing red	Deck is still.	
	Solid green	Deck is rotating.	
	OFF	Equipment is not powered.	
	Solid red	When the oven is on	“BAKING 1” or “BAKING 2” cycle on going
		When the oven is off	Equipment is powered and in stand-by
	Green		Program complete
	Off		Equipment is not powered

8.2 First startup of the oven



First Level Operator: the operator, with no specific skills, who is able to use the equipment in normal working condition and for simple maintenance interventions.



Once the oven has been correctly installed, before starting it up for the first time the user should first operate a pre-heating cycle in order to remove water residue inside the concrete mix used in the baking chamber by taking the following steps:

- phase 1. Heating of the baking chamber at a temperature of 100°C for a duration of 16 hours (2 working days);
- phase 2. Heating of the baking chamber at a temperature of 200°C for a duration of 16 hours (2 working days);
- phase 3. Heating of the baking chamber at a temperature of 300°C for a duration of 16 hours (2 working days);



During the pre-heating phases, the water vapour generated by the concrete can lead to water dripping around the area occupied by the oven. We also inform you that this event can in some cases occur for several months since the first time the oven is operated.

The operating guidelines for the oven's first startup are available here below.

1		<p>ON/OFF-STOP key The key activates different functions according to the equipment's status:</p> <p>With the equipment turned off: PI activates the mains supply power to the oven. The engine rotates, heating sheated elements OFF and burner turned off</p> <p>With the equipment turned on PM the equipment turns off.</p>
2		<p>Image shown when starting the machine. After some seconds the display will show the next page. This page displays important information such as:</p> <ul style="list-style-type: none"> - The equipment's serial number (SN: 00560) - Hour and date (23:40 WEDNESDAY 22/03/2015). - Program version of the console and bedplate (Vrs.: C1.99 / B1.88)

3		<p>After a few seconds the display shows the "STANDBY" page which includes information on the current status of the oven.</p> <ul style="list-style-type: none"> Burner flame level (turned off) Oven status information Baking chamber temperature with Image of the burner OFF Image of the Sheated element being OFF
4		<p> TOUCH key burner-sheated element the display shows the heating control page.</p> <p> Burner graphic key ON-OFF. Turn on-off the burner.</p> <p> burner turned off (OFF) burner turned on (ON)</p> <p> With the graphic key auto/man select the automatic function. With the function keys + / - set the baking temperature to 100°C (phase 1).</p>

At the end of the phase 1 you move to the next phases with a similar mode of action.







8.3 Normal operation

Once the first startup phase is over and the optimum temperature is reached, the oven is ready for normal operation.

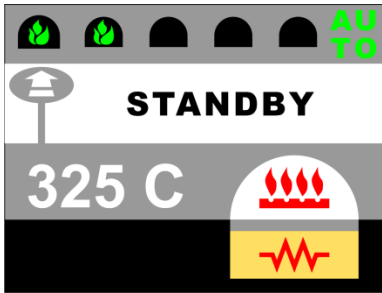

First Level Operator: the operator, with no specific skills, who is able to use the equipment in normal working condition and for simple maintenance interventions.

The following description illustrates the normal operating sequences.



1		<p>ON/OFF-STOP function key</p> <p>ON/OFF-STOP key functions (with the equipment turned off):</p> <ul style="list-style-type: none"> • PM (ca. 2 seconds) enables the supply mains power to the oven (the equipment turns on and displays the operating conditions that were active before it was turned off). <p>ON/OFF-STOP key functions (with the equipment turned on):</p> <ul style="list-style-type: none"> • PI stops only the engine rotation, the next PI will re-start the engine; • PM (ca. 2 seconds) turns off the oven.
2		<p>Some seconds after startup, the display shows the STANDBY page. The display shows the status information about the main oven's parameters. Specifically, the figure shows the following information.</p> <p> Automatic operating mode with increasing flame level. (the mode can be switched from auto to manual changing the flame color displayed)</p> <p> Baking chamber temperature with burner icon ON.</p> <p> Baking chamber temperature with burner icon OFF.</p> <p> Sheated element status: sheated element icon ON.</p> <p> Sheated element status: sheated element icon OFF.</p>

8.3.1 Manual operating mode.

Operating condition for the oven to maintain or reach the baking chamber temperature at the desired value manually.

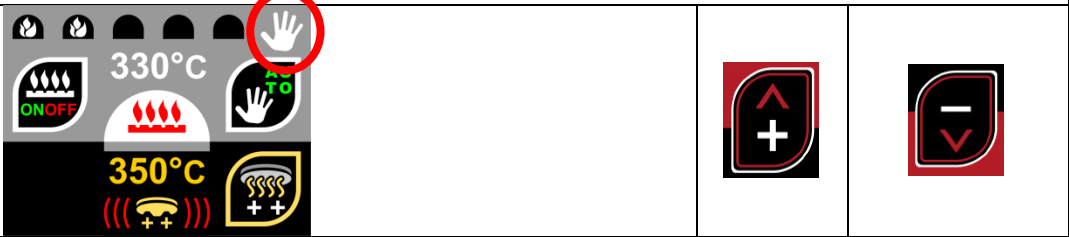

Working in this mode allows the user to directly control flame’s height.

It is enabled with PI TOUCH key burner-sheated element from the STANDBY page.

1		<p>TOUCH key burner-sheated element</p>  <p>Graphic key. Selects the Manual mode:  is displayed in top right corner. With function keys + and - the operator sets the burner's flame level. The flames displayed at the top of the screen will be white. With this mode on, the temperature control is not enabled. Pressing + or – function keys will change the number of flames displayed on the top of the display from a minimum of 1 to a maximum of 5 flames. The flame’s height inside the chamber will vary accordingly.</p> <p> Graphic key. Activates or deactivates the deck's heating sheated element (the status conditions is shown on the display). Check the sheated element control chapter for more information</p> <p>With the graphic key EXIT the STANDBY page is shown.</p>
---	--	--

8.3.2 Automatic operating mode.

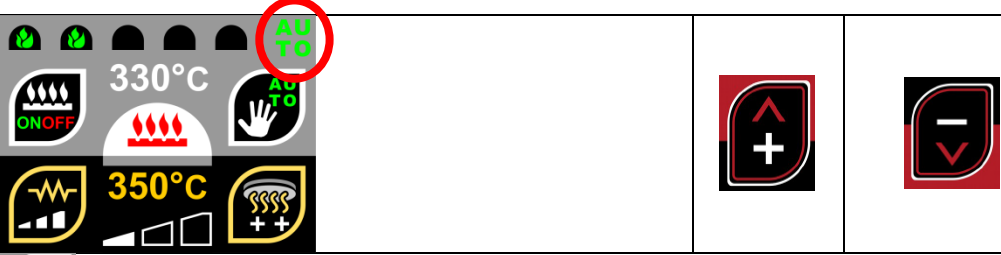
It is enabled with PI TOUCH key burner-sheated element from the STANDBY page.

<p>1</p> 	 <p>Graphic key selects the Automatic mode:  icon is displayed on the top right corner of the status display. With the function keys + and – the operator sets the desired temperature level for the baking chamber. The flames displayed at the top of the screen will be green. With this mode on, the temperature control is enabled and the flame will automatically be managed by the system to reach and maintain the requested temperature.</p> <p>Keeping + or – function key pressed for more than 2 seconds will increase the variation speed.</p> <p> Activates or deactivates the deck's heating sheated element (the status conditions is shown on the display). Check the sheated element control chapter for more information</p> <p>With the graphic key EXIT the STANDBY page is shown.</p>
--	--

8.3.3 Sheated element control and setup

It is enabled with PI TOUCH key burner-sheated element from the STANDBY page.

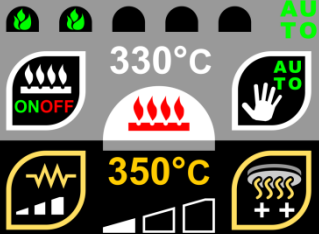
<p>1</p> 	<p>From the STANDBY page TOUCH key burner-sheated element</p> 
--	---



Graphic key switches the baking chamber's heating sheated element status. The operating condition will be shown on the display.

The actual temperature is displayed in yellow above the status indicator. The displayed temperature **does not indicate the cooking deck's surface temperature**. The measurement is taken from the area below the deck and is mainly used for the probe to regulate the automatic start/stop cycle (description below).

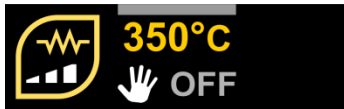

The sheated element status is displayed on the bottom part of the display and shows the sheated element behaviors according to the user's settings. The sheated element will be set OFF as a default option.



Pressing the  graphic key once will change the status to ON. In this status the sheated element will always be powered until its status is manually changed. No thermostatic control is applied to the sheated element.





Pressing the  graphic key again will change the status to AUTOMATIC. This status has 3 different levels that help the computer to determinate the Start/stop cycle for the sheated element. Different parameters are taken into account to regulate the cycles and higher regulation levels will increase the sheated element impact on the deck's temperature.



Graphic key will be displayed when AUTOMATIC mode is on. Pressing this key will immediately start the sheated element for a fast pre-heating cycle. It is used to help fast start the deck heating process at the beginning of the work session.

8.3.4 “BAKING 1” and “BAKING 2” programs.

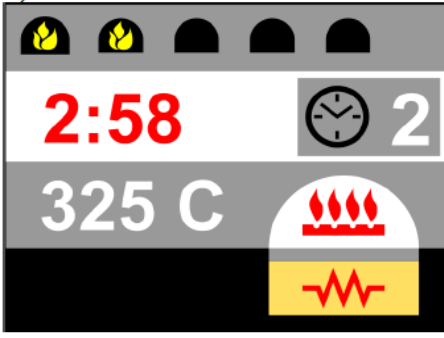
The oven works as per the operating settings stored in the “BAKING 1” or “BAKING 2” programs.
The baking process is regulated with user-customized level values for the burner's flame, duration and deck's rotation speed.

1		<p>Pressing the “BAKING 2” function starts its specific baking program. The pre-stored values are applied: flame level, baking time, deck rotation speed and final speed.</p> 	<p>While the program is on, the display will show the oven's current operating conditions.</p> <p>A. Burner's flame level. B. Remaining baking time. The operator can increase or decrease the baking time using the function keys +/- with intervals of 10 seconds. C. Temperature of the oven. D. Temperature of the deck (sheated element turned on)</p> <p>With PI “BAKING 1” key you can interrupt or restore the baking program. With PM “BAKING 1” key you activate the Program complete procedure.</p>
2		<p>Pressing the burner control key will allow to manually change the flame level during the baking program. This change will only influence the actual program's values and no changes will be applied to the stored program.</p>	
3		<p>STOP key</p> <ul style="list-style-type: none"> - PI the deck rotation stops, PI again to restart rotation. 	

The operating modes of the “BAKING 1” function keys are totally similar to the “BAKING 2” key modes.

	<p>For ease of operation, the system's control electronics is equipped with a remote control that enables the following functions:</p> <ul style="list-style-type: none"> - “BAKING 1” function key (key 1) - “BAKING 2” function key (key 2) - STOP function key (stops the baking deck rotation).
---	--



“ROTANTE” pizza oven

8.4 Program complete.

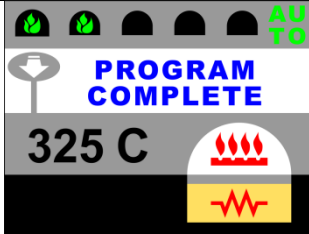

The oven's operating mode upon baking time completion or upon the operator's request, it activates an audible signal during approximately 4 seconds which is followed by a temporary reduction in the deck rotation speed.

The oven's speed reduction is configured in the respective program's settings (see the following page, #fn 3 and 7). Speed reduction time is set by the oven's general configuration parameter (see the paragraph Setting parameters for the oven's general configuration).

9. Setting parameters for the oven's general configuration.

The control electronics allows the user to customize all the oven's operating parameters.



During the configuration phase, the oven keeps the preceding operating status. Unless otherwise specified, the configured changes are immediately active.

Access to configuration logs is enabled from the STANDBY page with PM (keep the button pressed) of the function key [+].

In this condition it is possible to scroll through the parameters you want to change using the keys [+] and [-].

For the ease of operation, the display shows information with lines of different colors associated with different functions:

GRAY	The line with a gray colored background shows some information about the oven's operating status and these cannot be modified until selected by the operator.
GREEN	Line with a green colored background. The parameter shown on the display can be changed by the operator. By touching the line, the background's color will change from green to white, the operator can change the parameter indicated in the area with a red colored background.
WHITE	The line with a white colored background allows the operator to make changes.
RED	Areas with a red background - parameter can be modified.

The setting modes are described here below.

Home screen

	<p># fn. 01 Identification number of the line associated with the single parameter to be set.</p> <p>1 2m58s Editable parameter. Selected line (in green) - by pressing it the background color will change to white, the stored parameter can be changed using the function keys +/-, the OK key ends the modification process, otherwise use the CANCEL key to exit the setting (without making any change).</p> <p>1 2,8 g/m Non editable parameter (until selected).</p>
--	---



“ROTANTE” pizza oven

#fn	
01	Time control of the BAKING 1 cycle (from 0.1 sec. to 99 minutes and 59 sec.)
02	Speed control of the baking deck rotation during the BAKING 1 cycle (from 0.5 to 5.5 rounds per minute) in RPM
03	Speed control of the baking deck rotation during the PROGRAM COMPLETE BAKING 1 phase (from 0.5 to 5.5 rounds per minute) in RPM
04	Flame level control during the BAKING 1 cycle (range 1-5)
05	Time control of the BAKING 2 cycle (from 0.1 sec. to 99 minutes and 59 sec.)
06	Speed control of the baking deck rotation during the BAKING 2 cycle (from 0.5 to 5.5 rounds per minute) in RPM
07	Speed control of the baking deck rotation during the PROGRAM COMPLETE BAKING 2 phase (from 0.5 to 5.5 rounds per minute) in RPM
08	Flame level control during the BAKING 2 cycle (range 1-5)
09	Speed control of the baking deck rotation when in STANDBY MODE
10	Time control for the PROGRAM COMPLETE phase (range 0,1 sec. to 99 minutes and 59 sec.)
11	Setting the rotation direction of the baking deck: clockwise or counterclockwise NOTE: The changes will take place only after the deck has been stopped and restarted with PI STOP ON-OFF button
12	Temperature display setting in Celsius or Fahrenheit scale.
13	Language setting for the displayed texts (Italian – English – etc.)
14	Remote controls pairing (max. 3). Select a position from 1 to 3 and press on the screen. Press any button on the remote control to complete the pairing procedure
15	Firmware UPDATE function. Operation conducted using a USB pen drive and following the information shown on the display. Insert USB key containing the fw update file in the slot, prior to selecting this option
16	Auto-control setting for the burner's flame minimum level (flame 1). The wizard is launched. This function can only control the levels managed by the MODUPLUS® within the ranges mechanically set. To change minimum and maximum levels refer to paragraph 7.4.1 - Setting minimum / maximum gas levels If the wizard stops before completing the operation, the previously recorded setting will be restored.
17	Oven internal light mode: <ul style="list-style-type: none"> • On • Off
18	Factory setup: remote guided assistance will be needed in order to access this menu. +39(0)30.9972249 to call the technical support center. Only an authorized Univex operator can ask you to modify the parameters within this menu.

10. MAINTENANCE



During the operation and even after a long time after turning the oven off, the cooking chamber will remain HOT. Consider this while leading any maintenance inside the oven.

The operations described in the following paragraph should always be carried out with the equipment turned off (equipment disconnecter set to OFF).



The user should regularly clean the equipment's external covering using a soft cloth moistened with neutral and non-aggressive detergents, and then wipe off with a dry cloth.

10.1 Daily maintenance



First Level Operator: the operator, with no specific skills, who is able to use the equipment in normal working condition and for simple maintenance interventions.

Remove any residue from the oven floor using a vacuum cleaner, a broom, a soft bristle brush or similar tools. Conduct the operation when **the oven is turned off** and with no flame inside the baking chamber, making sure that the electrical sheated element under the baking deck is off.



Do not use water or detergents to clean the oven's baking deck or any internal part of the oven.

10.2 Periodic maintenance

Recommended time interval: once a week



Before each periodic maintenance, disconnect the oven from its power supply, making sure that the standby red led signal on the control console is turned off.



First Level Operator: the operator, with no specific skills, who is able to use the equipment in normal working condition and for simple maintenance interventions.

Type of intervention:

Remove the baking residue in the area under the rotating deck:

Remove the locking screws on the front part of the oven landing and pull out the first section of the oven landing by sliding it outwards. Disconnect the contact wires to the safety thermostat on the left and pull the metal oven landing out by sliding it outwards. When pulling it out, please pay special attention to the electrical sheathed element making sure you don't break or tear anything apart.

Once the 2 oven landing sections have been removed, you can start cleaning the wall clearance under the baking deck using a vacuum cleaner, a broom, a soft bristle brush or similar tools.

Once you finished cleaning, put the oven landing back in place and re-connect the thermostat on the left. Insert also the front part of the oven landing and tighten again the front locking screws.

Recommended time interval: once every 2 years



Manufacturer's Technician: the qualified technician who has been designated by the manufacturer to carry out complex operations in specific situations or, in any case, on the basis of what has been agreed upon with the user. Depending on each case, the personnel is requested to have mechanical and/or electrical and/or electronic and/or IT skills.

Type of intervention: Cleaning and maintenance of the gas burner, combustion adjustment and control.

Type of intervention: Greasing the beads below the rotating deck. Accessing the 2 beads positioned below the deck, from the bottom of the oven, add some grease in order to allow a proper and smooth rotation of the mechanical components.

Recommended time interval: once every 10 years



Manufacturer's Technician: the qualified technician who has been designated by the manufacturer to carry out complex operations in specific situations or, in any case, on the basis of what has been agreed upon with the user. Depending on each case, the personnel is requested to have mechanical and/or electrical and/or electronic and/or IT skills.

Type of intervention: Inspection and adjustment of the baking deck and internal dome.

11. INCONVENIENCES AND ANOMALIES

id	VISIBLE CODES	DESCRIPTION	B	R	ACTION
2	22	Burner block for spark failure	YES	NO	Check gas, electrodes or 220V inversion + RESET (see below)
2	25	Burner block for false flame signal at startup	YES	NO	Turn the oven off RESET (see below) and restart
2	27	Burner block for losing the functioning flame signal	YES	NO	Check the burner electrodes and if gas is flowing + RESET (see below)
2	29	Burner block due to fault inside the valve	YES	NO	Contact customer support
2	2C	Burner block due to fault inside the valve	YES	NO	Contact customer support
2	2D	Burner block due to fault inside the valve	YES	NO	Contact customer support
2	2E	Burner block due to fault inside the valve	YES	NO	Contact customer support
2	2F	Base-Valve communication broken	YES	NO	Check the valve cable and/or contact customer support
3	31	Temperature PROBES circuit error (X0 reading)	@	NO	Send to customer support
3	32	Temperature PROBES circuit error (X1 reading)	@	NO	Send to customer support
3	34	Error reading J1 probe (oven)	@	NO	Check if J1 probe can be operated
3	38	Error reading J2 probe (base-subplate) [§]	@	NO	Check J2 probe (change to OFF if absent)
3	3C	J probes general error:	@	NO	Check if J1 and J2 probes can be operated
3	30-31-32-33-35-36-37-39 -3A -3B -3D	Temperature probe circuit critical errors	@	NO	Send to customer support
4	40	Error reading board internal temperature	@	NO	Send to customer support

4	41-42-43- 44-45-46- 47-48-49- 4A-4B-4C- 4D- 4E- 4F	Temperature probe circuit board general errors	@	NO	Send to customer support
6	64-65-66- 67-68-69	Wiring board internal error	YES	YES	Serious error - contact customer support
6	6A-6B-6C- 6D	Wiring board overflow parameter	YES	YES	Serious error - contact customer support
7	70	Internal clock failure or low/missing battery	YES	YES	Serious error - contact customer support
7	71	Deck overheating notice	NO	NO	Sheated heating element is on and the deck is not rotating. Turn off the elec. sheated element or restart deck rotation.
F	F0	Base-Console communication broken	YES	YES	Serious error - contact customer support

[S] = If “Sheated element” is set to “OFF” (Manual) there's no error reported

B = Burner blocked

R = Deck Rotation blocked

@ = It can be also used with burner in manual mode

RESET = Manual resetting of the gas burner. In order to reset, press and hold the red button next to the console **for 2 seconds** and release it. The displayed error will disappear and you can try again to start it up.



If the suggested operation did not solve the malfunctioning, interrupt the operation and ask for help to the customer support center.



Do not open the equipment's external covering if you're not expressly authorized in writing by Univex. The non-observance to this rule will lead to the immediate invalidation of the warranty and of the retailer's ensuing responsibilities for aspects concerning safety and functioning.



“ROTANTE” pizza oven

12. INTERVENTION REQUEST FORM - REPLACEMENT PARTS

Dear:

*Univex Corporation
3 Old Rockingham Road
Salem NH, 03079
Tel.603-893-6191
service@univexcorp.com*

Date _____.

REPLACEMENT PART ORDERING - FAULT REPORTING - INFORMATION FORM

Client:	Model
Location	Code
Address	Serial n.
Telephone	
Fax:	Sent by

Replacement part ordering table:

Product code	Qty	Notes

APPLICANT'S STAMP AND SIGNATURE

Technician visit requested for the following faults:
Fault notes or description





“ROTANTE” pizza oven

13. REPLACEMENT PART LIST

Product description	Product code
Rotating deck heating sheated element	XRES6U
Deck rotation engine	XMTU018
Gearbox 1	XRDT40
Gearbox 2	XRDT90
“Giravolta” touch screen control panel	YPNLGRV/U
Oven lamp (internal led only)	YCBLAMP
Lamp bloc (lamp, lamp-holder, Pirex glass, metal lamp-holder and wiring)	YLIGHT
Flame detection electrode	ZELETRIV
Startup electrode	ZELETACC
Gas valve, including gas modulator	ZVK410
Gas valve safety and control module	ZS456
Reset button	ZPLSLUM

14. ATTACHMENT LIST

This manual also includes the following documents:

Type of document	Code
Electrical wiring scheme	Univex-Rotante-scheme-USA.pdf



“ROTANTE” pizza oven

15. WARRANTY

16. WARRANTY CONDITIONS AND RESTRICTIONS:

Univex guarantees the product for a period of 12 months. The warranty becomes effective as per the purchase date indicated on the invoice when the equipment is delivered. Univex agrees to repair or replace without charge all parts within the warranty period if they fail due to a manufacturing defect. The warranty does not include any form of compensation resulting from direct or indirect damages to persons or things. As long as the warranty is effective, if the Client desires that the repair should be carried out by Univex technicians, they should send a written request to Univex. In this case, they will also take charge of all the costs associated with travel, board and lodging. For interventions due to defects or faults that are not clearly linked to materials or manufacturing, all costs deriving from travels, repair and/or replacement of all parts will be charged to the buyer. The warranty cannot be extended after a repair intervention is carried out on the equipment. In case parts of the equipment are returned, the Client can make the shipment only after receiving the written authorization from Univex. Costs of packing and shipping are charged to the client (unless the parties agree otherwise). In any case, the warranty does not cover accidental damages resulting from transportation, negligence, inappropriate use, non-compliance with the instructions described in this manual, and from any event that does not depend on the normal operation or use of the equipment. The warranty expires if the equipment is repaired by non-authorized third parties or if you use tools or accessories that are not provided, recommended or approved by Univex, or in case the registration number is removed or altered during the warranty period. The warranty ceases immediately to be effective upon default or delay in payment. Univex declines any responsibility for any damages to persons or things resulting from the wrong or inappropriate use of the equipment.