

DUCTLESS MINI SPLIT SYSTEM AIR CONDITIONER / HEAT PUMP

PIONEER®

WYT-17 Inverter Series

For 12,000-36,000 BTU/hr Systems

Diamante Essenza Series - WT Indoor and YN Outdoor

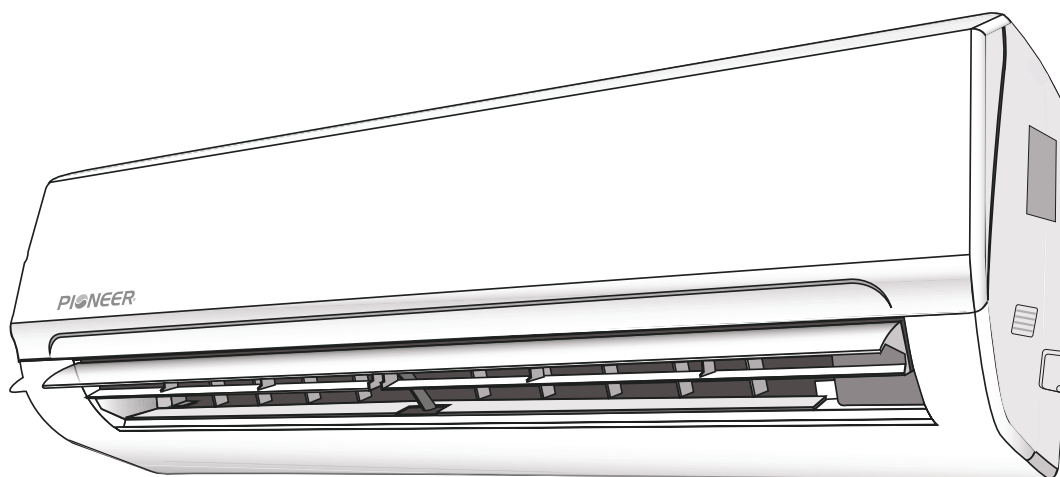

Installation & User's Manual

IMPORTANT NOTICE:

Please read this manual carefully before installing or operating your new air conditioning system. Be sure to save this manual for future reference.



REV250331

Table of Contents

Installation Manual

0	Safety Precautions.....	4
1	System Components.....	6
2	Included Accessories.....	7
3	Indoor Unit Overview.....	8
4	Operating Instructions.....	9
	1. Remote Buttons Overview.....	9
	2. Remote Controller LED Screen And Icons...	10
	3. Handling the Remote Controller.....	11
	4. Controlling the System's Airflow.....	12
	5. Indoor Unit Mode Settings.....	13
	6. Extra Options and Settings.....	15
	7. Managing the Timer Features.....	17
	8. Other Features.....	18
	9. Operating Temperature Notes.....	20
5	Maintenance Instructions.....	21
6	A2L Refrigerant Information.....	22
7	Indoor Unit Installation.....	32
	1. Pre-Mounting Instructions.....	32
	2. Indoor Unit Installation Location Selection.....	33
	3. Preparing the Refrigerant Piping.....	36
	4. Preparing the Drain Line.....	37
	5. Preparing the Signal Cable.....	38
	6. Routing the Copper Lines and Mounting the Unit.....	39

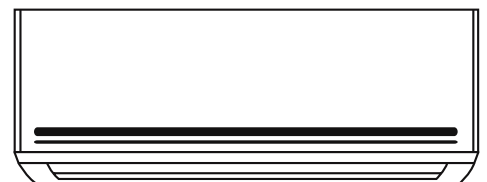
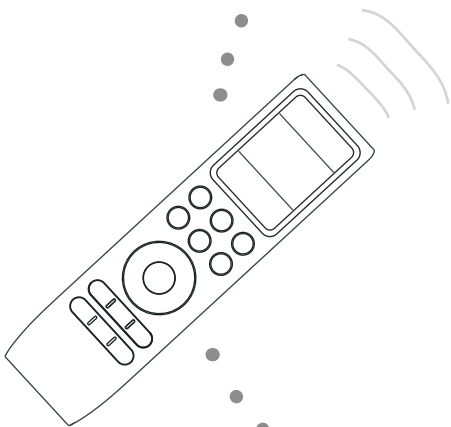
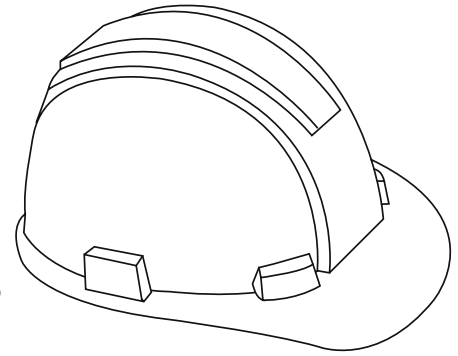

8	Outdoor Unit Installation.....	40
	1. Mounting Instructions.....	40
	2. Outdoor Unit Installation Location Selection.....	41
	3. Electrical Wiring of the Outdoor Unit.....	42
	4. Connection of Refrigerant Piping.....	44
	5. Evacuating the Refrigerant Circuit.....	47

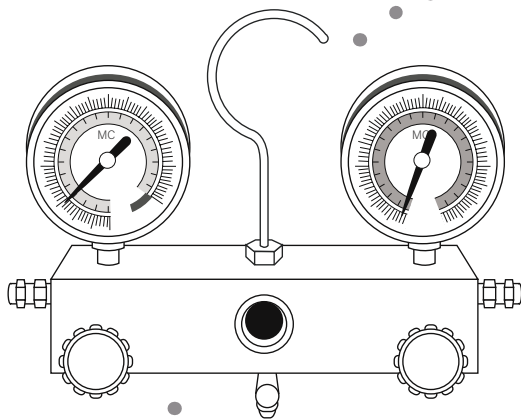
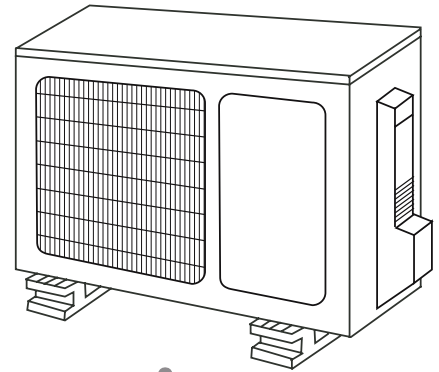

9	Leak Check/Test Run.....	49
	1. Electrical and Gas Leak Check.....	49
	2. Test Run.....	50

T	Troubleshooting.....	51
----------	-----------------------------	-----------

A	Appendix.....	53
	1. Anchoring the Outdoor Unit Guide.....	53
	2. Guidelines for Drilling the Wall Hole.....	54
	3. Simplified Wiring Diagram.....	55
	4. Indoor Unit Control Board Diagrams.....	56
	5. Outdoor Unit Control Board Diagrams.....	57
	6. European Disposal Guidelines.....	58
	7. Notes from the Installer.....	59

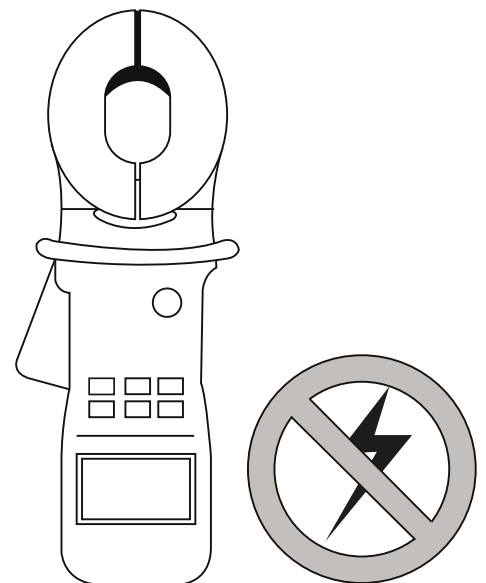

Safety Precautions

Read and Understand All Safety Precautions Prior to Installation

Improper installation due to negligence of instructions may result in death, property damage, or serious injury. The magnitude of potential damages or injuries is classified as either a WARNING or a CAUTION.



WARNING

This symbol indicates that ignoring the related instructions may cause death, or serious injury.



CAUTION

This symbol indicates that ignoring the related instructions may cause moderate injury to nearby persons, and/or damage to your appliance or other property.



DANGER

This symbol indicates that you must never perform the action shown.



WARNING

- ⊘ Do not power the system using an extension cable or with wiring smaller than the specified gauge. Do not share the electrical circuit with other appliances. Improper or insufficient power supply can cause undesirable operation, fire, or electrical shock.
 - ⊘ When connecting refrigerant piping, do not let any substances or gases other than the specified refrigerant enter the unit. The presence of other gases or substances will lower the unit's capacity, and can cause abnormally high pressure in the refrigeration cycle. This can also cause explosion and injury, as well as permanent equipment failure. Remember: No dust, humidity or air is allowed to enter.
 - ⊘ Do not allow children to play with or around the air conditioner. Children near the unit must be supervised at all times.
1. Installation must be performed by trained personnel according to applicable codes. Defective installation can cause water leakage, electrical shock, or fire. The usage of proper tools is required.
 2. Installation must be performed according to the installation instructions. Improper installation can cause water leakage, undesired performance, electrical shock, or fire. (In North America, installation must be performed in accordance with the requirements of NEC and CEC, by authorized personnel.)
 3. Contact a qualified and licensed HVAC technician for any repairs or maintenance of this unit.
 4. Only use the included accessories, parts, and specified items for installation. Using non-standard parts can cause water leakage, electrical shock, fire, and can cause total unit failure.
 5. Install the unit on top of a firm structure that can fully support its weight. If the chosen location cannot support the unit's weight, or the installation is not done properly, the unit may fall and cause serious injury and damage.

WARNING

6. For all electrical work, follow all local and national wiring standards, regulations, and especially this Installation Manual. You must use an independent circuit and a dedicated breaker to supply power. Do not connect other appliances to the same circuit. Insufficient electrical capacity or defects in electrical work can cause electrical shock or fire.
7. For all electrical work, use the specified cables. Connect cables tightly, and clamp them securely to prevent external forces from damaging the terminals. Improper electrical connections can overheat and cause fire, and may also cause shock.
8. All wiring must be properly arranged to ensure that the control board cover can close properly. If the control board cover is not closed properly, it can lead to corrosion and cause the connection points on the terminal to heat up, catch fire, or cause electrical shock.
9. In certain functional environments, such as kitchens, server rooms, etc., the use of specially designed air-conditioning units is highly recommended. This is intended as a general comfort cooling system.
10. If part of the electrical wiring is damaged, it must be replaced by a certified service agent or similarly qualified technicians, in order to avoid a hazard.
11. This appliance can be used by children aged 8 years and above, as well as persons with reduced physical, sensory, or mental capabilities, or lack of experience or knowledge, if they have been given supervision or instruction concerning use of the appliance in a safe way, and understand the hazards involved. Children shall not play with or near the appliance. Cleaning and user maintenance shall not be done or attempted by children or untrained personnel without proper supervision.

CAUTION

- ⊘ For units that have an auxiliary electric heater, do not install the unit within 1 meter (3 feet) of any combustible materials.
 - ⊘ Do not install the unit in a location that may be exposed to combustible gas leaks. If combustible gas accumulates around the unit, it may cause fire.
 - ⊘ Do not operate your air conditioner in a highly humid space, such as bathrooms or laundry rooms. Exposure to high humidity or water can cause electrical components to short circuit.
1. The product must be properly grounded at the time of installation, else electrical shock may occur.
 2. Install drainage piping according to the instructions in this manual. Improper drainage may cause water damage to your home and property.

Note about Fluorinated Gasses

1. This air-conditioning unit contains fluorinated gasses. For specific information on the type of gas and the amount, please refer to the relevant label on the unit itself.
2. Installation, service, maintenance, and repair of this unit must be performed by qualified and well-trained personnel.
3. Product removal and recycling must be performed by a certified HVAC technician.
4. If the system has a leak-detection feature installed, it must be checked for its functionality at least every 12 months.
5. When the unit is being checked for leaks, proper logging and record-keeping of all checks is strongly recommended.

System Components

1

High Wall-Mounted Air Conditioner:

The system is made up of two units connected together via insulated copper pipes and an electrical communication cable. The indoor unit is mounted onto one of the walls in the room that is to be conditioned. The outdoor unit is installed on the ground outside or on the wall of the dwelling using suitable mounting brackets.

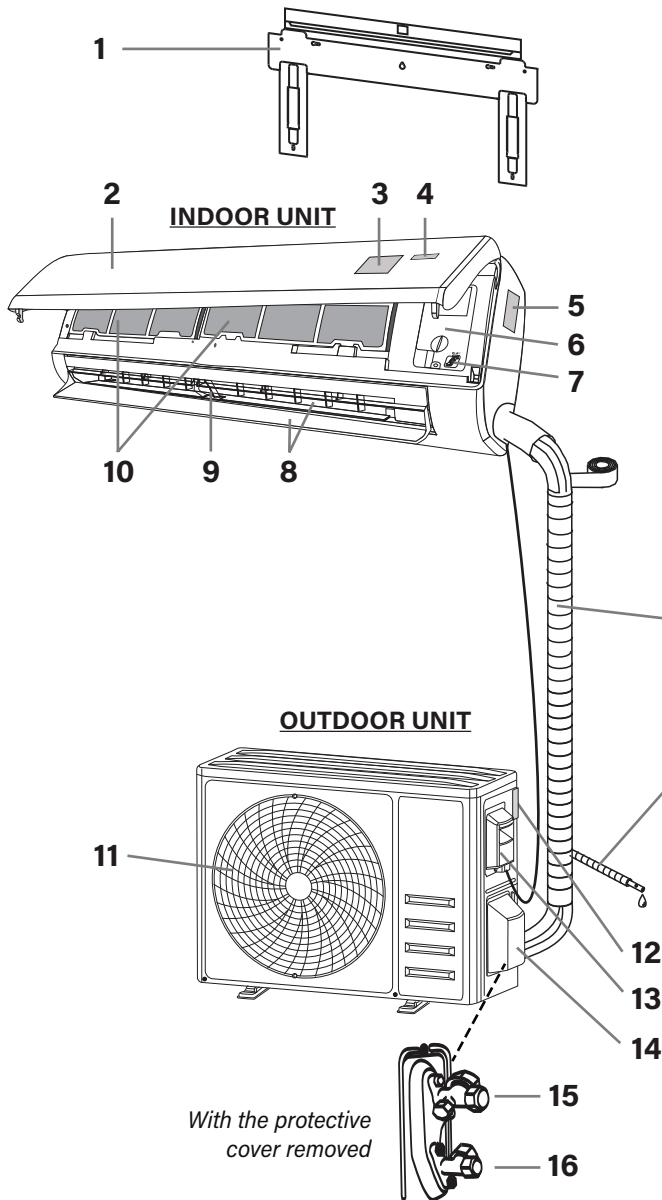

No.	Description
1	Wall Mounting Plate
2	Front Panel
3	LED Display
4	Controller Signal Receiver
5	Indoor Unit Rating Label
6	Terminal Block Cover
7	Emergency (Manual) Button
8	Air Deflector and Flap
9	Air Outlet
10	Air Filter

No.	Description
11	Air Outlet Grille
12	Outdoor Unit Nameplate
13	Terminal Block Cover
14	Valve Protection Cover
15	Gas (Suction) Line Valve
16	Liquid Line Valve

Note: Serial Numbers are typically located behind the electronic control box cover cap of either unit.











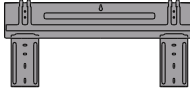

Note: The illustrations above are only intended to be a simple diagram of the appliance, and may not fully correspond to the actual appearance of the system. Technical data is printed on the system's labels.

Included Accessories

2

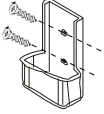
Accessories and Components:

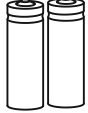
The air conditioning system comes with the following accessories. Use all of the installation parts and accessories to install the air conditioner. Improper installation may cause the equipment to fail, or result in water leakage, electrical shock, or fire.

Name	Appearance	Name	Appearance
1x Installation and Owner's Manual		1x Indoor Unit Mounting Plate	
1x Warranty Card		1x Set of Mounting Plate Screws	
1x 16 ft. Communication Cable		1x Plastic Drain Joint Plug for Outdoor Unit (use only for wall-mounted condensers)	
1x 16 ft. Insulated Copper Pipe		1x Condensate Drain Hose	
1x Remote Controller		1x Wrapping Tape	
1x Remote Controller Holder		1x Wall-Hole Packing Sealant	
2x Remote Controller Batteries		1x Wall Sleeve	
		1x Allen Wrench for Opening Service Valves	

Connecting Pipe Diameters		
BTU Capacity	Gas Line	Liquid Line
12000	3/8"	1/4"
18000		1/4"
24000	1/2"	1/4"
36000	5/8"	1/4"

Note: This is a general list of package contents. There may be a slight variance in included items depending on the model. Pioneer reserves the right to modify the included components for product improvement without notice.



Indoor Unit Overview



Front Panel Display:

No.	LED Icon	Symbol	Description
1	POWER	⏻	Indicates that the unit is currently powered on
2	SLEEP	☾	Indicates that the system is currently in SLEEP mode
3	Temp. Display	88	Displays the current set temperature or any error codes
4	TIMER	⌚	Indicates that the TIMER function has been set
5	RUN	🌀	Indicates that the fan is currently on and running

The shape and position of switches and indicators may vary according to the model, however the functions remain the same. There may be variances between the amount of digits that are shown on the remote (3) vs. the amount on the indoor unit (2).

Emergency Manual Button And Auto-Restart Function

The emergency button is located at the terminal block cover of the unit under the front panel.

Front Panel

Emergency Button

Emergency Manual Button

If the remote controller fails to operate the system, proceed as follows:

- Open and lift the front panel up at an angle to gain access to the emergency button.
- Press the manual button once to start the unit in COOL mode.
- Press the button again within 3 seconds to start the unit in HEAT mode.
- Press a 3rd time within 5 seconds to turn OFF the unit.

Auto-Restart Feature

This appliance is programmed with an auto-restart function.

In case of sudden power failure, the control module will remember the settings configured before power loss.

When power is restored, the unit will restart automatically, and will be set to the previous settings, which were preserved with this memory function.

Operating Instructions

4

Remote Buttons Overview

Button	Description
	Turns the air conditioner on or off
	Increases set temperature, set timing, or navigates the functional menu
	Decreases set temperature, set timing, or navigates the functional menu
MODE	Selects the mode of operation (Auto, Cool, Dry, Fan, and Heat modes)
ECO	Activates/deactivates the ECO feature
	Long press to activate the 46°F "Away from Home" freeze protection setting.
TURBO	Activates/deactivates the TURBO feature, which allows the system to reach set temperatures more rapidly
FAN	Configures the fan speed (Auto, Low, Mid, and High)
TIMER	Configures the automatic on/off times
SLEEP	Toggles the system's Sleep Mode
DISPLAY	Turns the LED display on or off
	Activates the up-down louver motor
	Activates the left-right louver motor
I FEEL	Activates the system's Follow Me mode
MUTE	Puts the system into silent mode
[LOCK]	Hold MODE+TIMER for child-lock
CLEAN	To activate/deactivate Self-Clean mode
MEMORY	To recall saved temp/mode/fan settings
ACC	<i>Reserved for Future Usage</i>



The display and some features of the remote control may vary according to the model of the system.



The shape and positions of the buttons and indicators may vary according to the model of the system, but the features and functionality would remain the same.



The unit will confirm the successful reception of each button command with a beep.

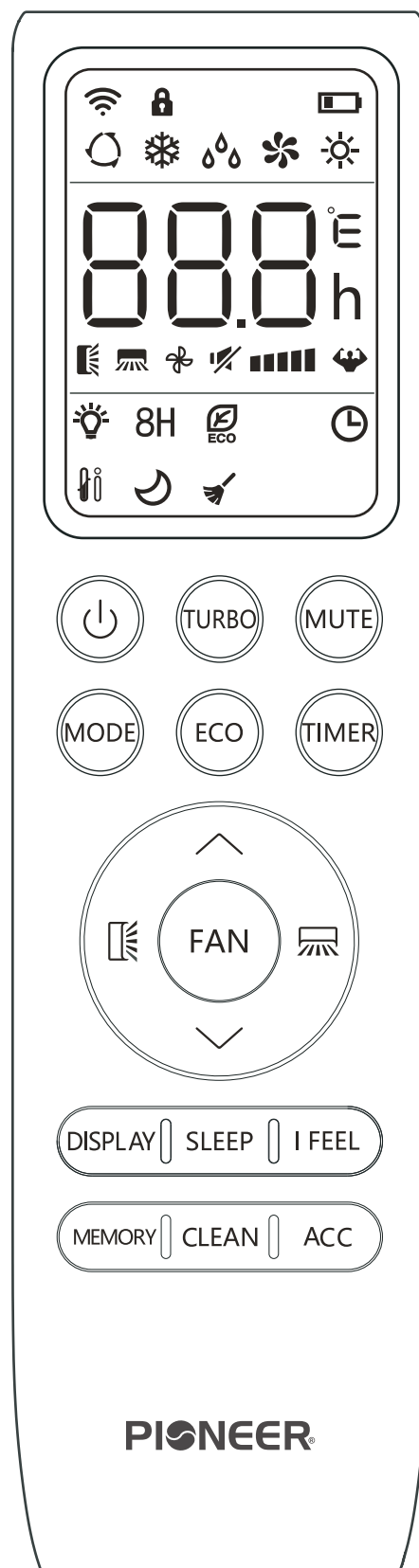

Operating Instructions

4

Remote Controller LED Screen and Icons

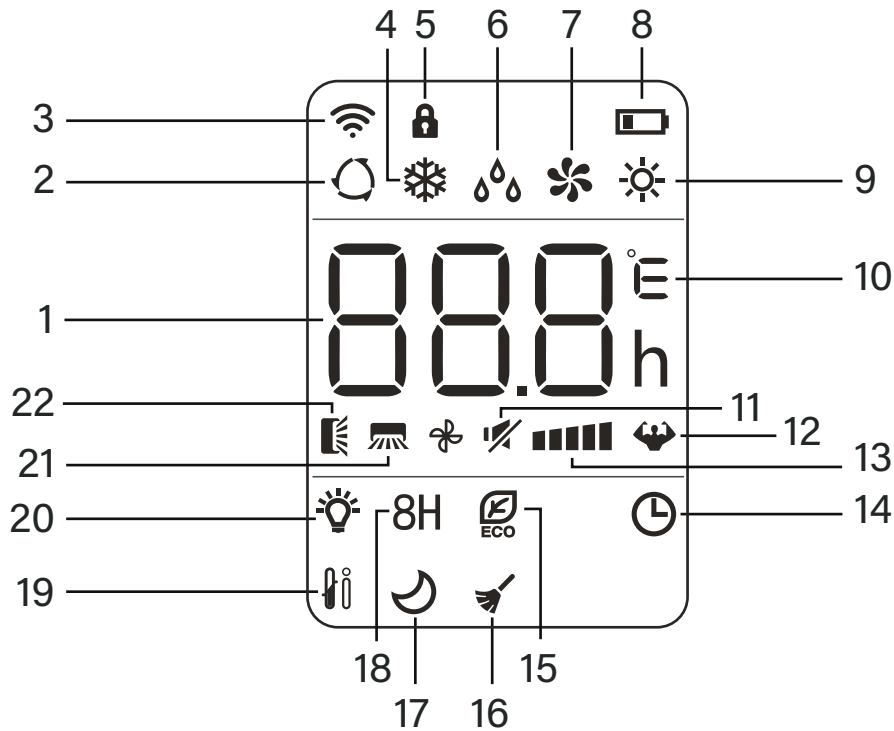

No.	Icon	Description
1	8.8	Temperature Indicator
2	↻	Auto Mode
3	📶	Signal Transmit Indicator
4	❄️	Cooling Mode
5	🔒	Child Lock Indicator
6	💧	Dry Mode
7	🌀	Fan Only Mode
8	🔋	Battery Level Indicator
9	☀️	Heating Mode
10	°E	Unit of Temperature (°C/°F)
11	🔇	Mute Function

No.	Icon	Description
12	👉	Turbo Mode
13	🌀 📶	Fan Speed (Auto or Fixed)
14	🕒	Timer Active Indicator
15	🌿	ECO Mode
16	🧹	Self-Clean Function
17	🌙	Sleep Function
18	8H	8°C (46°F) Heating Function
19	👤	I Feel/Follow Me Mode
20	💡	LED Display On/Off
21	🌀	Left-Right Swing Indicator
22	🌀	Up-Down Swing Indicator

NOTE ON ILLUSTRATIONS

The illustrations in this manual are strictly for explanatory purposes. The actual display and some functions of the remote controller may vary according to the model purchased.

Operating Instructions

4

Replacement of Batteries

Remove the battery cover from the rear of the remote controller, by sliding it downward in the direction of the arrow as depicted below. Install batteries according to the depicted directions (+ and -) as shown on the remote controller. The cover then slides back into place.



Use 2x AAA batteries. Do not use re-chargeable batteries. Replace old batteries with new ones of the same type when the display is no longer legible. Do not dispose of batteries as unsorted municipal waste. Disposal of such waste separately for special treatment is necessary. If the system will not be used for a long time, remove batteries to prevent leakage.

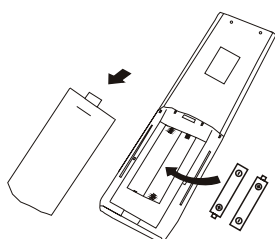

Note

Please remove batteries to avoid leakage damage when not being used for a long time.

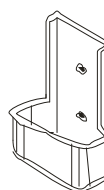

Note

The remote can be placed inside the cradle when not in use (may be sold separately).

Configuring Remote Controller Settings (some models)

Depending on the system, the control type (Cooling Only or Heat Pump) and the unit of Temperature (°C or °F) can be configured using the controller buttons. Operate as below. **All configuration must be done as soon as batteries are inserted into the remote.**

Press and Hold:	Functional Result
MODE	When ❄️ flashes, Cooling Only Mode
MODE	When ☀️ flashes, Heat & Cool Mode
TURBO ↓ TURBO (press)	After 5 seconds, enter Change Mode ↓ Switch between °C and °F units

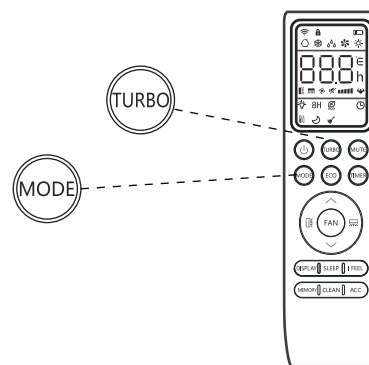

Remove batteries and re-insert to reprogram as many times as needed.

Operating the Remote Controller Successfully and Safely

- Ensure no objects come between the remote controller and signal
- Keep the remote at least 3 ft away from televisions and other electrical appliances.
- Always direct the remote controller toward the air conditioner.
- Don't leave the remote exposed to sunrays.

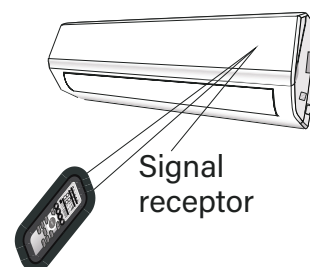

Operating Instructions

4

Regarding the Airflow of the Indoor Unit

The air that is pulled in by the fan (the "return air") enters the grille and is passed through the filter. It is then cooled/dehumidified/heated through the heat exchanger.

The direction of the air output is manipulated up and down by the motorized louver, and left to right via manually controlled vertical deflectors. Some models may come with "dual-swing" capability, which offers both a horizontal and vertical motorized air flow swing.

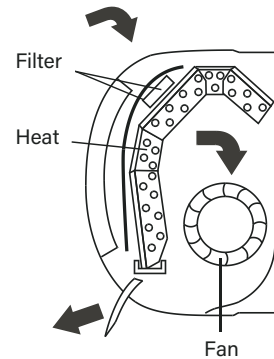

Controlling the System's Airflow

1. Pressing the buttons activates the air direction adjusters.

- Press the Swing button to trigger the horizontal flaps to swing up and down. Press this button again to stop swing movement at the current angle.
- Press the Swing button to trigger the vertical flaps to swing left and right. Press this button again to stop swing movement at the current angle.

2. If the vertical deflectors (which are located underneath the flaps) are adjusted manually, they can be used to fix the airflow in a certain vertical position before turning the system on.

Note: On some models, long-pressing either of the SWING buttons for >3 seconds allows more fine adjustment of airflow angle.

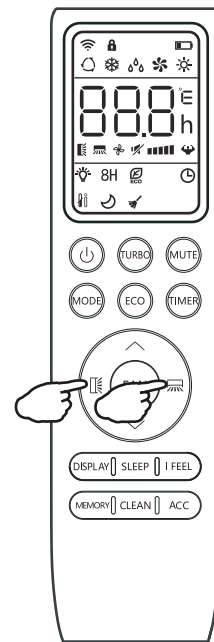

CAUTION

- Do not manipulate the louvers themselves manually, or serious damage may occur.
- Deflector adjustments should be made only when the system is switched off.
- Never poke fingers, sticks, or other objects into the air inlet/outlet vents.

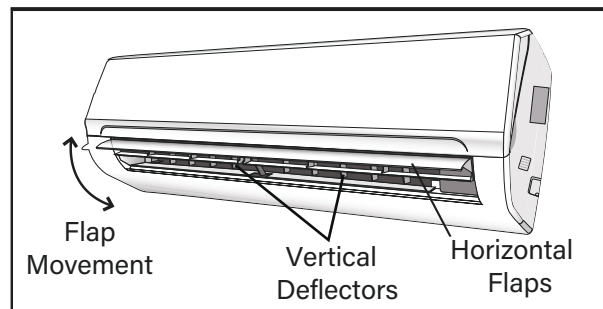





Operating Instructions

4

COOLING Mode



Cooling mode allows the heat pump to cool the room while also reducing the humidity of the air in the room.



To put the system into cooling mode, press the  button until the  symbol appears on the remote's display.

The  and  buttons can then be used to set a temperature lower than that of the room.

HEATING Mode

Heating mode allows the heat pump to warm the air in the room by reversing the cooling cycle.

To put the system into heating mode, press the  button until the  symbol appears on the remote's display.

The  and  buttons can then be used to set a temperature higher than that of the room.

Note that the system may take up to 10 minutes before it begins delivering heat in order to allow for the coil to warm up and prevent cold airflow.

Fan speed is not available to the user in the same way that it is in cooling mode. Rather, the fan will blow out air at a speed that is in proportion to how much the heat exchanger has been warmed up to.

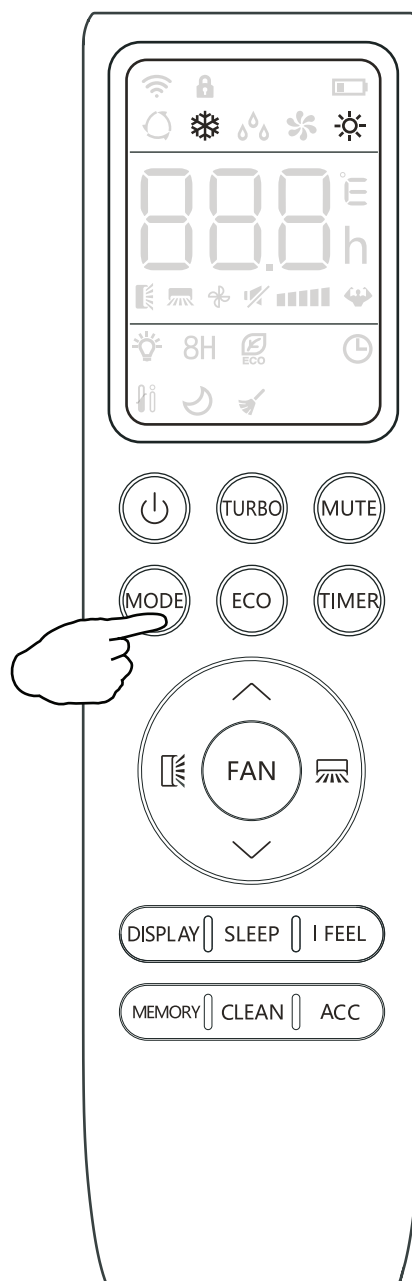

NOTE

In heating mode, the appliance will periodically enter a defrost cycle, which is essential in order to clean frosting off the condenser and recover heat exchange capability. This process is normal and lasts for 2-10 minutes.



During defrosting, the indoor unit's fan will cease operation. After the cycle is completed, the system will resume its normal heat mode operation automatically. Press ECO 10 times within 8 seconds to trigger a forced defrost.

Operating Instructions

4

DRY Mode



Dry mode is a limited function that can rapidly reduce the humidity/moisture of the room.

To put the system into dry mode, press the  button until the  symbol appears on the remote's display.

An automatic preset of this mode is then activated.

FAN-ONLY Mode

Fan-only mode is used to set the system to use only air ventilation and no heating or cooling.

To put the system into fan-only mode, press the  button until the  symbol appears on the remote's display.



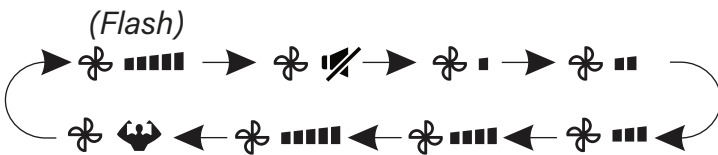

Use the  button to then set the desired fan speed. The system will cycle from **AUTO**→**MUTE**→**LOW**→**LOW-MID**→**MID**→**MID-HIGH**→**HIGH**→**TURBO**



AUTO Mode

In Auto mode, the system selects cooling, heating, or fan-only mode based on the delta-T (ΔT), which is the difference between Room Temperature & Set Temperature.

ΔT (RT-ST)	$\Delta T > 2^\circ F$	$-2^\circ F \leq \Delta T \leq 2^\circ F$	$\Delta T < 2^\circ F$
→MODE	Cooling	Fan-Only	Heating

To put the system into AUTO mode, press the  button until the  symbol appears on the remote's display. The  and  buttons can then be used to set the desired room temperature.

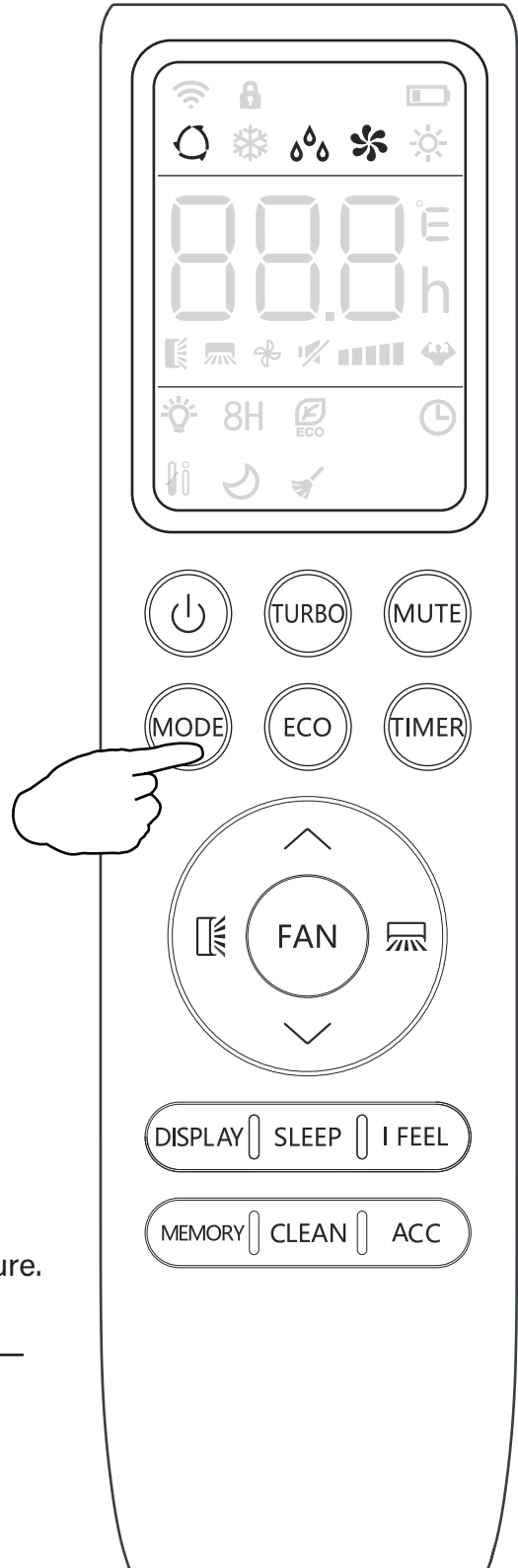

Operating Instructions

4

Turning the Display On or Off

The LED display on the front panel of the system can be turned on or off as desired.

To do so, press the **DISPLAY** button in order to switch off the LED display on the front panel. This button can be pressed again to turn the LED display back on again.

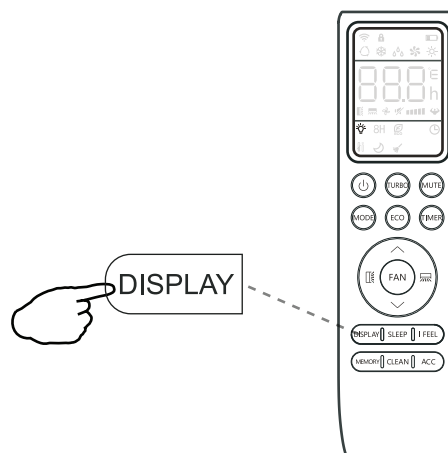

SLEEP Mode

Sleep mode is generally meant for periods of lesser cooling/heating requirements, such as during typical sleeping hours. This mode will result in decreased energy use, and can only be activated via remote control.

After 10 hours in sleep mode, the air conditioner will revert back to the previously set mode.

To put the system into sleep mode, press the **SLEEP** button, and the  symbol will appear on the display. Press this button again to exit from this mode.

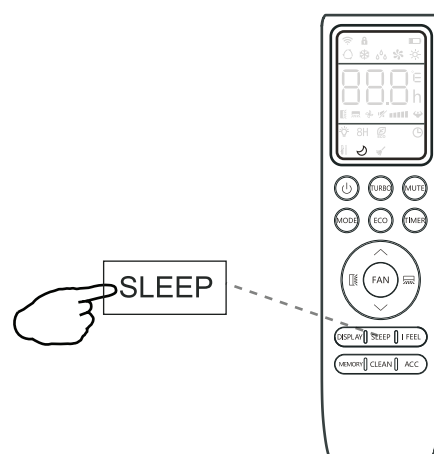

I FEEL - To Ensure Comfort

The I FEEL feature enables the remote to act as the temperature sensor and relay the current air temperature of where the remote is physically placed within the room. In some cases, this can aid with reducing thermal drift between the set temperature and the actual room temperature.

In order to activate this feature, press the **I FEEL** button, and the  icon will appear on the display.

NOTE

The I FEEL feature will automatically de-activate itself 8 hours later (or 2 hours on some models).

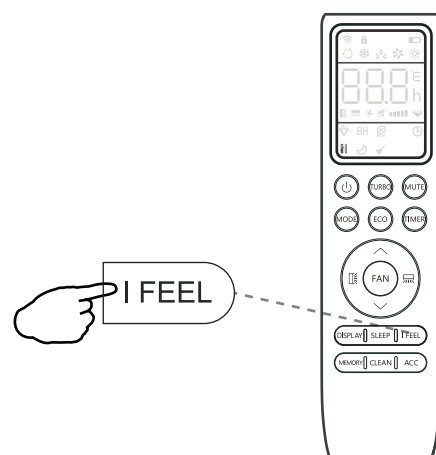



Operating Instructions

4

Energy Saver (ECO) Option

In this mode, the appliance will automatically manage its operation in order to save energy.

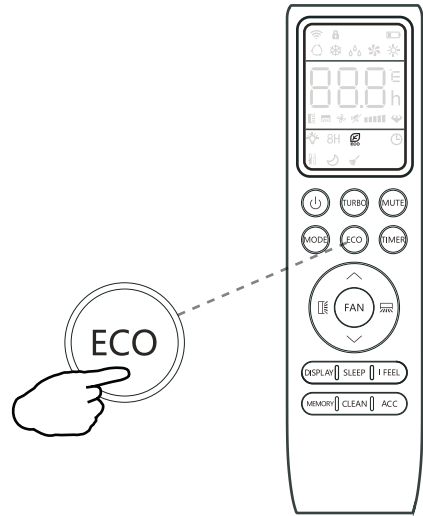

To turn the ECO feature on, press the  button on the remote, and the  icon will appear. The system is now running in ECO, and the process can be repeated to turn it off.

NOTE
The ECO feature is available in both COOLING and HEATING modes.





TURBO Option

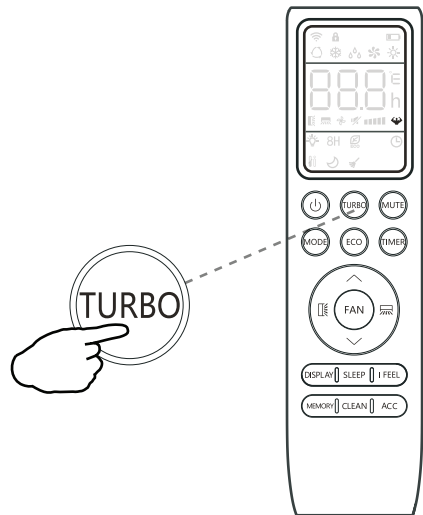

In this mode, the appliance will operate using the highest fan speed in order to maximize output and reach the set temperature in the quickest way.

To turn the TURBO feature on, press the  button on the remote, and the  icon will appear. The system is now running in TURBO, and the process can be repeated to turn it off.



Child-Lock Function

Pressing  and  buttons together will activate the child-lock function. When this function is active, the  icon will be displayed, and no single button will be active.

Press the  and  buttons together once more to de-activate the child-lock function.

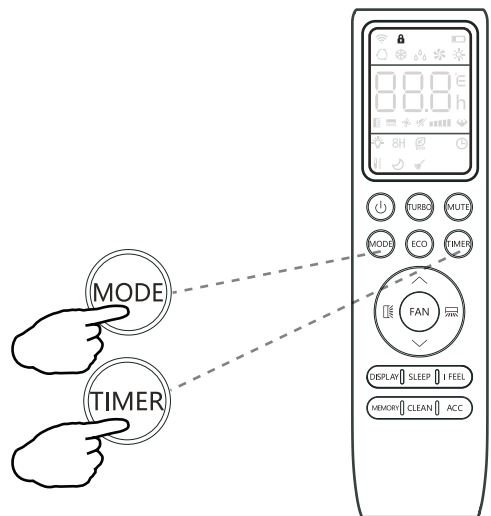









Operating Instructions

4

Using the Timer - TIMER ON

The TIMER feature allows you to set a time delay for the system to turn itself on or off.



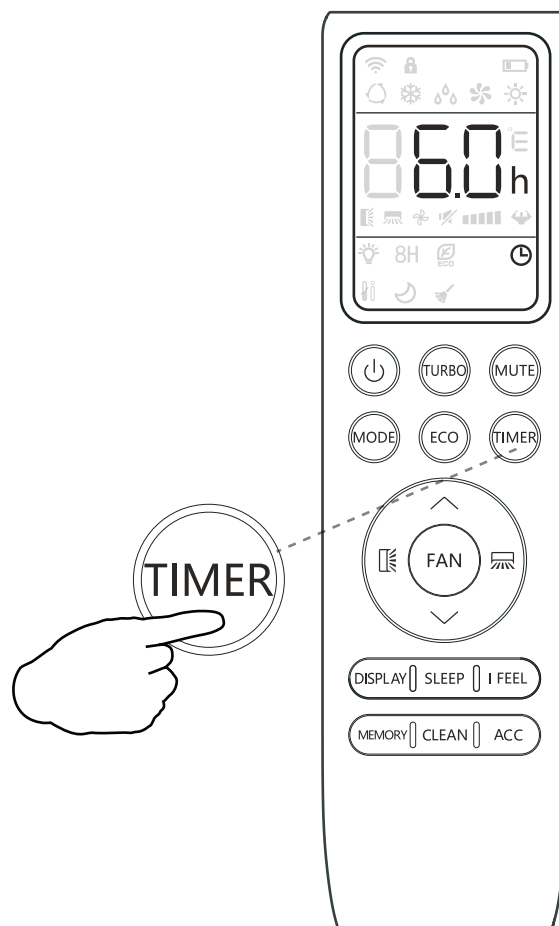

To set a time delay for the system to turn itself on in X amount of hours:

1. Begin by pressing the  button while the system is powered off. The  symbol will then display flashing. The default setting is 6.0 hours.
2. Use the Temp  and  buttons to set the needed time delay in 30 minute increments.
3. Press the  button a second time to confirm.
4. Press the  button to select the desired operating mode that the unit should start up in.
5. Set the desired fan speed that the unit should start up in by pressing the  button.
6. Use the  and  buttons to set the desired operation temperature. The unit is now primed.



Using the Timer - TIMER OFF

The TIMER OFF feature allows the appliance to turn itself off after X amount of hours have passed. The symbol  will appear. To set a time delay for the system to turn itself off in X amount of hours:

1. Confirm that the appliance is on and running.
2. Press the  button to enter the prompt for switching off the system. Use the  and  buttons to configure the time delay setting.
3. Press the  button again to confirm. It can also be pressed once more to cancel the setting.

NOTE Regarding Timers

- Press the  button to cancel at any time in Timer Off.
- The programming will cancel if no buttons are pressed after 5 seconds. This may require restarting the process.

Operating Instructions

4

46°F Freeze Protection Function

This feature is meant to be used to prevent freezing while the user is away from home. When turned on, it sets the system to keep a temperature of 46°F. If the unit is in standby, then the setting will automatically start the heating mode when the room temperature is equal to or lower than 46°F. It will set the system back to standby when the room temperature reaches 48°F.

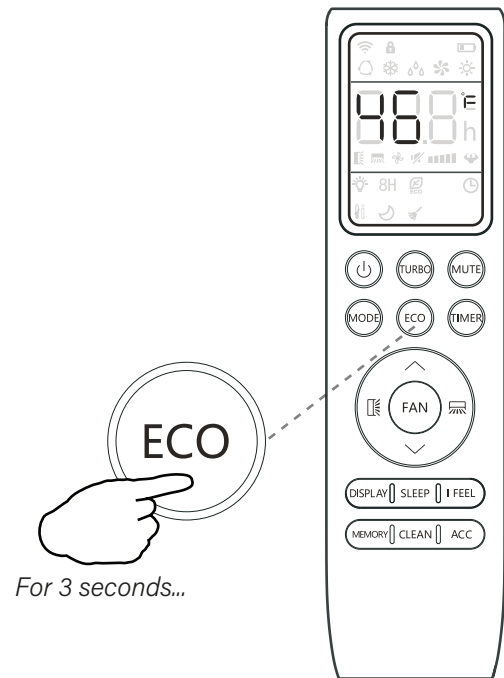

If the room temperature is ever 64°F or higher, then the appliance will cancel or prevent this feature automatically.

Press and hold the  button for 3 seconds to activate this feature. Repeat this to de-activate. Once activated, 46°F (8°C) will appear on the display.



MUTE Mode

When the system is muted, the remote controller will display AUTO fan speed, and the indoor unit will operate at its lowest fan speed in order to minimize operation noise.

Press the  button in order to activate this mode. The  icon will display to indicate that the system is muted.

This mode can be cancelled by pressing either the FAN, TURBO, or SLEEP buttons.

NOTE

The MUTE feature cannot be activated when the system is in DRY mode.

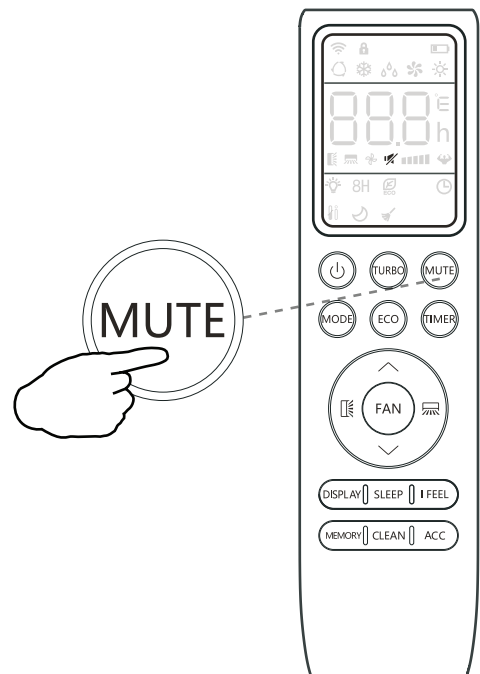

Operating Instructions

4

MEMORY Feature

The Memory feature enables the user to store their favorite setting and reconfigure the system to that same setting with the press of a single button. Each mode of HEAT/COOL/FAN/DRY can store a unique setting.

To use this feature, enter the desired mode and set the system to your preferred configuration and press and hold the **MEMORY** button for 3 seconds to store the configuration. The system will flash "AU" to acknowledge that the configuration has been stored successfully.

Enter the desired mode of HEAT/COOL/FAN/DRY and press the **MEMORY** button to activate the stored configuration.

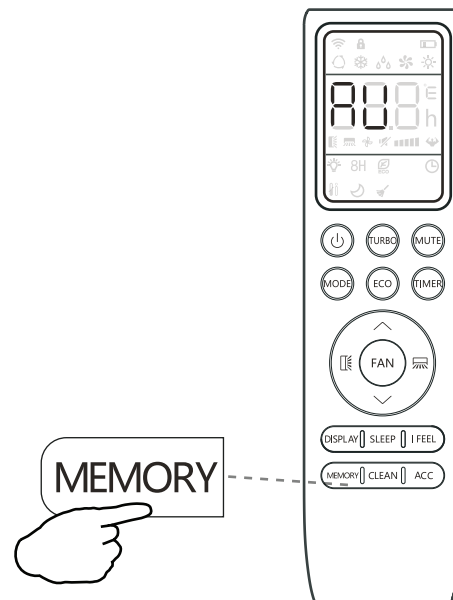

SELF-CLEAN Feature

This feature helps carry away some of the accumulated dust, dirt, bacteria, and other microbial contents away from the indoor evaporator.

To activate this feature, press the **CLEAN** button until a beep is heard from the unit, the  icon displays and AC will be displayed on the unit and remote. This procedure will run for approximately 30 minutes, before returning to the preset mode.

The  button can be pressed to cancel this feature during the process. Two beeps will be emitted from the machine when it is finished, or cancelled.

This procedure can result in some uncommon noise coming from the machine. This noise is normal as a side effect of the plastics expanding and contracting due to reactions with heat and cold.

It is recommended to use this function only when indoor temperature is under 86°F and outside temperature is between 41°F and 86°F.

It is suggested to run this feature once every 3 months.

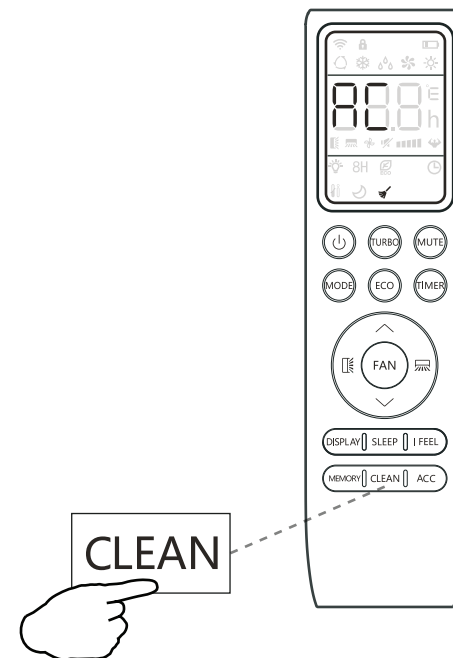

NOTE:

This feature does not replace the requirement of proper periodic maintenance and cleaning, especially for dusty/high-particle environments.

Operating Instructions

4

An Important Note Regarding Operating Temperatures

The system is designed to run within a certain range of temperatures, which are listed below. There are built-in protections with the system that may stop the appliance when the ambient temperatures goes outside of these ranges.

Inverter Air Conditioner

Temperature \ Operating Mode	COOLING Mode	HEATING Mode	DRYING Mode
Operational Room Temperature Range	63°F - 90°F	32°F - 80°F	63°F - 90°F
Remote Control Setting Range	61°F - 88°F		
Ambient Outdoor Temperature	54°F - 122°F	5°F - 86°F	54°F - 122°F

NOTE

After stopping and restarting the air conditioner, or after the mode is changed during operation, the system does not restart immediately, and will come on when three minutes have elapsed (as a protection for the compressor).

Full system-rated capacity and efficiency is obtained at the standard rating conditions as developed by the testing and rating agencies. Deviations from the rating conditions, especially the atmospheric conditions, will be compensated by the variable speed compressor, within certain limitations.

Heat pump systems function by exchanging energy, in the form of heat, between the indoor air and the outdoor ambient air (atmospheric). The system's net cooling or heating capacities and efficiencies change by atmospheric conditions, as well as the indoor air conditions (such as temperatures and humidity levels).

Capacity of the system required for a specific area or application must be determined professionally using detailed calculations, which are based on several internal and external factors.

To further optimize the performance of your unit, be sure to do the following:

- Keep doors and windows closed.
- Limit energy usage by using TIMER ON and TIMER OFF functions.
- Do not block air inlets or outlets.
- Regularly inspect and clean air filters.

Periodic Maintenance Is Essential For The System!

Maintaining the air conditioner will ensure that it stays efficient. Before carrying out any sort of maintenance, always ensure that the power supply to the system is turned off for >5 minutes. Wear safety gloves when working on the equipment, due to sharp aluminum fin edges of the coil.

Indoor Unit

Anti-Dust Filters (Inspect once every 2 weeks)

1. Open the front panel by pulling outward and upward at the indicated location.
2. Keep the front panel raised with one hand and take out the air filters with the other.
3. The filters are washable and should be cleaned with warm water (under 104°F).
4. Leave the filters to dry in a cool, dry place.
5. Keeping the front panel raised with one hand, insert the air filters with the other.
6. Close the front panel.

Any accessorial electrostatic or deodorizing filters, if installed, are not washable and should be replaced once every 6 months.

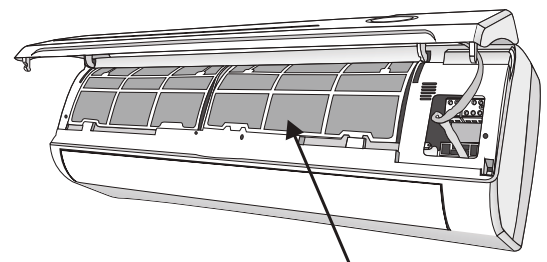
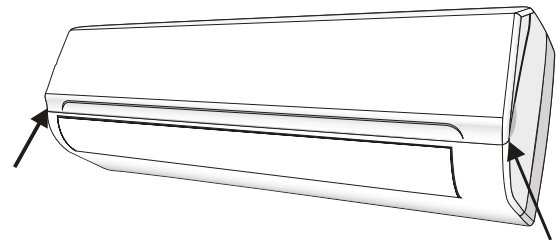

Anti-Dust Filter

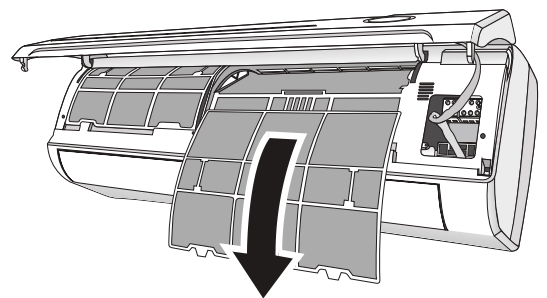

Interior of the Indoor Air Handler

In addition to the filters, the interior of the indoor unit itself as well as the inner coil should be inspected every season. The front panel can be disconnected and removed from the top hinge where the pegs connect. This will allow for easier inspection of the interior and behind the air filters. The interior should be cleaned with damp cloth and neutral soaps. Do not use any sort of aggressive solvents or detergents. Only a soft cloth that is lightly dampened should be used.

⚠ BEFORE CLEANING OR MAINTENANCE

ALWAYS TURN OFF YOUR AIR CONDITIONER SYSTEM AND DISCONNECT ITS POWER SUPPLY BEFORE PERFORMING CLEANING OR MAINTENANCE. DO NOT SPRAY WATER DIRECTLY NEAR THE INDOOR UNIT, AS IT CAN DAMAGE INSULATION AND ELECTRICAL COMPONENTS.

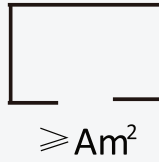

A2L



Safety Information for A2L Refrigerants

Because your system contains R-32 refrigerant, the following notices should be read and followed. It must be noted that venting any type of refrigerant into the atmosphere is always illegal and is punishable under federal and local regulations. Always read and obey all applicable local EPA laws.

- Refer to this manual for the required installation space dimensions, including the minimum clearance distances from adjacent structures.
- The appliance must be installed, operated, and stored in a room with a floor area of at least the minimum allowed (**see Page 31**).
- The length of the refrigerant piping should be kept to a minimum.
- The refrigerant piping must be protected from physical damage and should not be installed in an unventilated space if the area of the space is smaller than the minimum.
- Installation must comply with all applicable national refrigerant regulations.
- All mechanical connections must remain accessible for maintenance.
- Follow the instructions in this manual for proper handling, installation, cleaning, maintenance, and disposal of the refrigerant.
- Ensure that all ventilation openings remain unobstructed.



Servicing must be performed only in accordance with the manufacturer's recommendations.



The appliance must be stored in a well-ventilated area with a room size that meets the minimum requirements specified for operation.



The appliance must be stored in a room free of continuously operating open flames (e.g., an active gas appliance) and ignition sources (e.g., an operating electric heater).

Any individual working on a refrigerant circuit must hold a valid, up-to-date certification from an industry-accredited assessment authority, verifying their competence in handling refrigerants per the recognized assessment specifications of the relevant industrial sector. Service operations must be performed strictly in accordance with the manufacturer's recommendations. Maintenance and repair tasks requiring assistance from additional qualified personnel must be conducted under the supervision of a certified professional competent in handling flammable refrigerants.

Servicing Information for A2L Refrigerants

- The appliance must be stored in a manner that prevents mechanical damage.
- Any work procedure affecting safety measures must be carried out exclusively by competent personnel.

Warning

- Do not attempt to accelerate the defrosting process or remove frost manually.
- Follow the manufacturer's recommended procedures.
- The appliance must be stored in a room free of continuously operating ignition sources (e.g., open flames, an active gas appliance, or an operating electric heater).
- Do not pierce or incinerate the appliance or its components.
- Be aware that refrigerants may be odorless.
- **Area Inspection:** Before servicing systems containing flammable refrigerants, safety checks must be performed to minimize the risk of ignition. When repairing the refrigeration system, all following precautions must be observed before beginning any work.
- **Work Procedure:** All work must be conducted under a controlled process to minimize the risk of flammable gas or vapor being present during servicing.
- **General Work Area:**
 - All maintenance personnel and individuals in the vicinity must be informed about the nature of the work being performed.
 - Avoid working in confined spaces whenever possible.
 - The work area must be sectioned off to prevent unauthorized access.

- **Area Ventilation:** Ensure the area is free from flammable materials and that conditions are controlled to maintain a safe working environment
- **Checking for Refrigerant Presence:**
 - The work area must be monitored for refrigerant leaks using an appropriate refrigerant detector before and during servicing.
 - Ensure the leak detection equipment used is suitable for flammable refrigerants (i.e., non-sparking, adequately sealed, or intrinsically safe).
- **Presence of Fire Extinguisher:** If any hot work is to be performed on the refrigeration equipment or its associated components, appropriate fire extinguishing equipment must be readily available. A dry powder or CO₂ fire extinguisher should be positioned adjacent to the charging area.
- **Elimination of Ignition Sources:**
 - Any work involving the exposure of refrigeration system piping must be conducted without the use of ignition sources that could pose a fire or explosion risk.
 - All potential ignition sources, including smoking, must be kept at a safe distance from the installation, repair, removal, and disposal areas, where refrigerant may be unintentionally released into the surrounding space.
 - Before commencing work, the area must be inspected to ensure that no flammable hazards or ignition risks are present.
 - "No Smoking" signs must be clearly displayed in the work area.

▪ **Ventilated Area:**

- Ensure that work is conducted either in an open area or in a space with adequate ventilation before breaking into the system or performing any heat-producing tasks.
- Ventilation must be maintained throughout the duration of the work.
- The ventilation system should effectively disperse any released refrigerant and, if possible, direct it safely to an external atmosphere.

▪ **Inspection of Refrigeration Equipment:**

- When replacing electrical components, ensure that they meet the correct specifications and are suitable for their intended purpose.
- Always adhere to the manufacturer's maintenance and service guidelines.
- If unsure, consult the manufacturer's technical support department for guidance.

▪ **Checks for Installations Using Flammable Refrigerants:** The following inspections must be performed for systems utilizing flammable refrigerants:

- Ensure that the refrigerant charge size complies with the minimum room size requirements where refrigerant-containing components are installed.
- Verify that ventilation equipment and exhaust outlets are functioning properly and are free from obstructions.
- If an indirect refrigeration circuit is used, inspect the secondary circuit for any presence of refrigerant.
- Confirm that all equipment markings remain visible and legible. Any illegible markings or signs must be replaced or corrected.

Ensure that refrigeration piping and components are installed in locations where they are not exposed to substances that could cause corrosion. If exposure is unavoidable, verify that the components are either made from corrosion-resistant materials or are adequately protected against corrosion.

▪ **Inspection of Electrical Devices:**

Repair and maintenance of electrical components must include initial safety checks and a thorough inspection of components. If a fault is detected that could compromise safety, the electrical supply must not be connected to the circuit until the issue is fully resolved.

- If the fault cannot be corrected immediately but continued operation is necessary, a temporary solution may be implemented, provided it is safe and effective.
- Any temporary measures must be reported to the equipment owner to ensure all relevant parties are informed.

▪ **Initial Safety Checks:**

- Ensure that capacitors are fully discharged in a controlled manner to prevent sparking.
- Verify that no live electrical components or exposed wiring are present during system charging, refrigerant recovery, or purging.
- Confirm that earth bonding continuity is maintained.

▪ **Repairs to Sealed Components:**

Sealed electrical components must be replaced rather than repaired.

▪ **Repairs to Intrinsically Safe Components:**

Intrinsically safe components must be replaced and not repaired.

Considerations for A2L Refrigerants

6

- **Cabling:** Ensure that cabling is not exposed to wear, corrosion, excessive pressure, vibration, sharp edges, or other adverse environmental factors. Consider the long-term effects of aging and continuous vibration from components such as compressors or fans.
- **Detection of Flammable Refrigerants:** Under no circumstances should potential sources of ignition be used for refrigerant leak detection. Halide torches or any other flame-based detection devices must not be used.
- **Leak Detection Methods:** The following methods are approved for detecting leaks in systems containing flammable refrigerants:
 - **Electronic Leak Detectors:** Must be used for detecting flammable refrigerants. However, they may require recalibration to maintain adequate sensitivity.
 - Detection equipment must be calibrated in a refrigerant-free area.
 - Ensure that the detector does not pose an ignition risk and is compatible with the refrigerant in use.
 - The detector must be set to a percentage of the refrigerant's Lower Flammability Limit (LFL) and calibrated to confirm that the appropriate gas concentration does not exceed 25% of the LFL.
 - **Leak Detection Fluids:** Suitable for most refrigerants but must not contain chlorine, as chlorine can react with the refrigerant and corrode copper piping.
 - **Safety Precautions:** If a leak is suspected, all open flames must be removed or extinguished. If a refrigerant leak requiring brazing is detected, all refrigerant must be fully recovered or isolated using shut-off valves to prevent accidental release.
 - **Oxygen-Free Nitrogen (OFN)** must be purged through the system before and during brazing.
- **Removal and Evacuation:** When accessing the refrigerant circuit for repairs or other procedures, industry-standard practices must be followed, with additional precautions for flammability:
 1. **Recover the refrigerant** into approved recovery cylinders.
 2. **Purge the circuit** using an inert gas (such as OFN).
 3. **Evacuate** the system.
 4. **Purge again** with inert gas.
 5. **Open the circuit** by cutting or brazing.
 - The system must be flushed with OFN to ensure safety. This process may need to be repeated multiple times.
 - Do not use compressed air or oxygen for flushing.
 - Flushing should be performed by:
 1. **Breaking** the system vacuum with OFN.
 2. **Filling** the system until the working pressure is reached.
 3. **Venting** to the atmosphere.
 4. **Pulling** the system down to vacuum.
 5. **Repeating** the process until no refrigerant remains in the system.
 - When the final OFN charge is introduced, the system must be vented to atmospheric pressure to allow for safe work. This step is critical before performing any brazing on pipework.
 - Ensure the vacuum pump outlet is positioned away from ignition sources and that adequate ventilation is present.

Decommissioning Information for A2L Refrigerants

◦ **Decommissioning:** Before starting decommissioning, the technician must be fully familiar with the equipment and its components. All refrigerant should be recovered safely as a standard best practice. Prior to decommissioning, an oil and refrigerant sample should be collected for analysis if reclaimed refrigerant is intended for reuse. Electrical power must be available before beginning the decommissioning process.

A. Familiarization: Understand the equipment, its operation, and the decommissioning process before beginning work.

B. Electrical Isolation: Disconnect the system from the electrical supply to prevent accidental activation during the procedure.

C. Pre-Procedure Safety Checks: Before proceeding, ensure the following:

1. Mechanical handling equipment is available if needed for refrigerant cylinder transport.
2. All required personal protective equipment (PPE) is present and correctly used.
3. A competent person supervises the entire refrigerant recovery process.
4. Recovery equipment and cylinders comply with all relevant safety and regulatory standards.

D. Pump Down the Refrigerant System: If possible, perform a pump-down procedure to remove refrigerant from the system.

E. Alternative Method if Vacuum is Not Possible: If a complete vacuum cannot be achieved, create a manifold to facilitate refrigerant removal from multiple points in the system.

F. Cylinder Positioning: Ensure the recovery cylinder is placed on a scale before starting the refrigerant recovery process.

G. Recovery Machine Operation: Start the recovery machine and follow the manufacturer's instructions for proper operation.

H. Cylinder Fill Limits: Do not exceed **80% of the cylinder's total volume** when filling with liquid refrigerant to allow for expansion.

I. Maximum Pressure Precautions: Do not exceed the **maximum working pressure** of the recovery cylinder at any time, even temporarily.

J. Finalizing the Recovery Process:

- Once the cylinders are correctly filled and the process is complete:
- Promptly remove the cylinders and recovery equipment from the site.
- Close all isolation valves on the equipment to prevent leaks.

K. Handling Recovered Refrigerant:

Recovered refrigerant **must not be recharged** into another refrigeration system unless it has been properly cleaned and tested to ensure compliance with safety and performance standards.

- **Labeling:** The equipment must be labeled to indicate that it has been decommissioned and emptied of refrigerant. The label must include the date of decommissioning and the signature of the responsible technician. Ensure that the equipment retains labels indicating the presence of flammable refrigerant, even after decommissioning.

Recovery Information for A2L Refrigerants

Recovery Procedure: When removing refrigerant from a system for servicing or decommissioning, the following best practices must be observed to ensure safety and compliance:

- 1. Safe Refrigerant Removal:** All refrigerants must be **safely removed** from the system following proper handling procedures.
- 2. Use of Appropriate Recovery Cylinders:** Only **approved refrigerant recovery cylinders** must be used.
 - A. Ensure that a **sufficient number of cylinders** are available to accommodate the total refrigerant charge from the system.
 - B. Each cylinder must be **designated and labeled** for the specific refrigerant being recovered (e.g., cylinders specifically designed for refrigerant recovery).
 - C. Recovery cylinders must be equipped with a **pressure-relief valve** and **functioning shut-off valves**.
 - D. Empty recovery cylinders should be **evacuated and, if possible, pre-cooled** before the recovery process begins.
- 3. Recovery Equipment Requirements:** The recovery equipment must be:
 - A. In **good working condition**.
 - B. Accompanied by **manufacturer-provided operating instructions**.
 - C. Suitable for recovering **all appropriate refrigerants**, including flammable refrigerants when applicable.
 - D. A calibrated weighing scale must be available to monitor refrigerant recovery accurately.
 - E. Hoses must be equipped with **leak-free disconnect couplings** and be in good condition.
- Before using the recovery machine: Verify that it is in proper working order and has been properly maintained. Ensure that any associated electrical components are sealed to prevent ignition in case of a refrigerant leak.
 - If in doubt, consult the manufacturer.
- 4. Handling Recovered Refrigerant:**
 - It is vital that:
 - A. The recovered refrigerant must be returned to the refrigerant supplier in the correct recovery cylinder.
 - B. A waste transfer note must be arranged for proper documentation and disposal.
 - C. Do not mix refrigerants in recovery units or cylinders under any circumstances.
- 5. Compressor and Oil Removal:**
 - If compressors or compressor oils need to be removed:
 - A. Ensure that they have been **evacuated to an acceptable level** to eliminate any remaining flammable refrigerant within the lubricant.
 - B. The evacuation process must be completed **before returning the compressor** to the supplier.
 - C. Only **electric heating** should be used to accelerate the evacuation of refrigerant from the compressor body. **Open flames or ignition sources must not be used.**
 - When draining oil from a system, the process must be conducted safely and in accordance with best practices.

Considerations for A2L Refrigerants

6

WARNING

- Do not use any unauthorized methods to accelerate the defrosting process or for cleaning. Follow only the manufacturer's recommended procedures.
- The appliance must be stored in a room free of continuously operating ignition sources (e.g., open flames, an operating gas appliance, or an electric heater).
- Do not pierce or burn any part of the system.
- Be aware that refrigerants may be odorless.

AVERTISSEMENT

- Ne pas utiliser de moyens non recommandés par le fabricant pour accélérer le dégivrage ou nettoyer l'appareil.
- L'appareil doit être entreposé dans un endroit sans source d'allumage fonctionnant en continu (par exemple : flamme nue, appareil à gaz en marche, ou radiateur électrique en marche).
- Ne pas percer ni brûler l'appareil.
- Attention : les frigorigènes peuvent être inodores.

COMPLIANCE

- **Minimum Installation Requirements:** The minimum installation height and minimum room area (for both operation and storage) must be in accordance with the installation manual.
- **Risk of Fire – Auxiliary Devices:** Ignition source auxiliary devices must not be installed within the ductwork, except for auxiliary devices specifically listed for use with this appliance. Refer to the installation instructions.
- **Mounting Clearance:** The system must be mounted with the lowest moving parts at least 2.5m (8ft) above the floor or grade level.
- **Risk of Electric Shock:** Serious injury or death may occur. Disconnect all remote electric power supplies before performing any servicing.
- **Risk of Fire – Flammable Refrigerant:** Flammable refrigerant is used. Maintenance and repairs must only be performed by trained service personnel. Do not puncture refrigerant tubing.
- **Risk of Fire – Proper Disposal Required:** Dispose of the system in accordance with all applicable federal and local regulations.
- Flammable refrigerant is used; ensure proper handling and disposal.
- **Risk of Fire – Service Precautions:** Flammable refrigerant is used. Refer to the repair manual/owner's guide before attempting to service this product.
- **Risk of Fire – Compliance with Regulations:** Due to the use of flammable refrigerants, follow handling instructions carefully and ensure compliance with national regulations.

USAGE STATEMENT

- Before unloading and opening the container, use a flammable gas detector to check for potential leaks.
- No fire sources or smoking are allowed in the vicinity.
- Pipework must be protected from physical damage. For **FLAMMABLE REFRIGERANTS**, pipes must not be installed in an unventilated space if that space is smaller than the minimum requirements stated in **Annex GG**, except in the case of **A2L REFRIGERANTS**, where installed pipes must comply with **22.116**. If field charging is required, the impact of different pipe lengths on the **REFRIGERANT CHARGE** must be quantified.
- Compliance with all **national gas regulations** must be ensured.
- **Mechanical connections** made in accordance with **22.118** must remain accessible for maintenance purposes.
- Pipework, including piping material, routing, and installation, must be protected from physical damage during operation and servicing. It must comply with all national and local codes and standards, including:
 - ASHRAE 15
 - ASHRAE 15.2
 - IAPMO Uniform Mechanical Code
 - ICC International Mechanical Code
 - CSA B52
 - All field joints must be **accessible for inspection** before being covered or enclosed.
- After field piping installation for split systems, the field pipework must undergo:
 - Pressure testing with an inert gas.
 - Vacuum testing before refrigerant charging, following the required standards.
- The appliance must be stored in a way that prevents **mechanical damage**.
- Maintenance, service, and repair operations must only be carried out by **qualified personnel** according to **Annex HH**.
- Only competent persons should perform safety-critical procedures, including:
 - Breaking into the refrigerant circuit
 - Opening sealed components
 - Opening ventilated enclosures

Considerations for A2L Refrigerants

6

Preparation for Working on Systems With A2L Refrigerants



No Flammable Sources



Ventilation Necessary



Wear Protective Gear



Don't Use Electronics Near System



Refrigerant Leakage Detector

A handheld leakage detector can aid with tracing and isolating refrigerant leaks. As such, it is recommended to have one handy whenever working on the system.

⚠ Determining Installation Location

It is vital that the systems are installed in suitable locations based on the guidelines given below. For best results, follow all requirements given in this manual when determining placement of the equipment.

Installation Site Requirements:

1. Ensure Proper Ventilation

- The installation site must be well-ventilated to allow safe operation and prevent refrigerant accumulation.

2. Keep Away from Heat and Fire Hazards

- The installation and maintenance sites for air conditioners using Refrigerant R32 must be free from open flames or heat sources.
- Avoid locations near welding activities, smoking areas, drying ovens, or any heat source exceeding 1000°F, as these can create ignition risks.

3. Implement Anti-Static Precautions

- Wear anti-static clothing and gloves to prevent static discharge when handling and installing the unit.

4. Select an Accessible Installation Site

- The installation location must allow easy access for maintenance.
- Indoor and outdoor units should not be surrounded by obstacles that restrict airflow.
- Avoid areas close to heat sources or environments with flammable or explosive materials.

5. Refrigerant Leak Emergency Actions

- If the indoor unit leaks refrigerant during installation, immediately shut off the outdoor unit valve.
- All personnel must evacuate the area for at least 15 minutes until the refrigerant fully dissipates.
- If the product is damaged, it must be transported to a maintenance station. Please note that on-site welding or refrigerant pipe repairs are strictly prohibited.

6. Ensure Even Airflow

- Choose a location where the air inlet and outlet flow of indoor unit remains unobstructed and evenly distributed.

7. Avoid Installing Near Sensitive Areas

- Do not install the indoor unit near:
 - Electrical devices or power outlets.
 - Kitchen cabinets, beds, sofas, or valuable items.
 - Areas where the airflow from the two sides of the unit could directly impact important objects.

Considerations for A2L Refrigerants

6

(If Applicable) Charging Protocol for A2L Refrigerants

Important Considerations:

1. The air conditioner must be installed and serviced by **qualified personnel**. Installation must comply with all instructions set forth herein as well as all local regulations.
2. Caution when handling combustible refrigerants – Improper or careless handling may cause **serious injury** or **damage to property**.
3. A **leak test** must be conducted after installation is completed to ensure system integrity.
4. Safety inspections are **mandatory** before performing maintenance or repairs on air conditioners using **combustible refrigerants to minimize fire risk**.
5. The system must be operated under **controlled conditions** to reduce the risk of **combustible gas or vapor hazards** during operation.
6. The **total weight of refrigerant charge** and **minimum room area requirements** for air conditioners must comply with the specifications outlined in **Tables GG.1 and GG.2**.

Maximum Refrigerant Charge and Required

Minimum Floor Area: The maximum charge is determined by the following equations:

$$m_1 = (6m^3) \times LFL, m_2 = (52m^3) \times LFL, m_3 = (260m^3) \times LFL$$

Where LFL is the Lower Flammable Limit in kg/m³.
For R32 refrigerant, LFL = 0.306 kg/m³.

For Appliances with a Charge Amount $m_1 < M = m_2$:

The maximum refrigerant charge in a room must comply with: $M_{max} = 2.5 \times (LFL)^{5/4} \times h_0 \times A^{1/2}$

This value must not exceed: $M_{max} = SF \times LFL \times h_0 \times A$

(Refer to GG.3DV for specific factors and application.)

Minimum Floor Area Requirement: The required minimum floor area A_{min} for an appliance with a refrigerant charge $M(kg)$ **must be calculated as follows:**

$$A_{min} = [M / (2.5 \times LFL^{5/4} \times h_0)]^2$$

However, A_{min} **must not be less than:**

$$A_{min} = M / (SF \times LFL \times h_0); \text{ with } SF=0.5$$

(Refer to GG.4DV for specific values/factors.)

Where Category = R32, LFL = 0.306 kg/m³

Table GG.1 - Maximum Charge (kg)

$h_0(m)$	Floor Area (m ²)	Charge Limit (kg)	
(Installed Height)	4 (43 ft ²)	1.10 (38.8 oz)	
	7 (75 ft ²)	1.93 (68 oz)	
	10 (107 ft ²)	2.75 (97 oz)	
	1.8 (6'0")	15 (161 ft ²)	3.97 (140 oz)
		20 (215 ft ²)	4.58 (161.5 oz)
		30 (322 ft ²)	5.61 (197.8 oz)
		50 (538 ft ²)	7.24 (255.3 oz)
(Installed Height)	4 (43 ft ²)	1.53 (38.8 oz)	
	7 (75 ft ²)	2.68 (68 oz)	
	10 (107 ft ²)	3.83 (97 oz)	
	2.5 (8'2")	15 (161 ft ²)	5.51 (140 oz)
		20 (215 ft ²)	6.36 (161.5 oz)
		30 (322 ft ²)	7.79 (197.8 oz)
		50 (538 ft ²)	10.06 (255.3 oz)
(Installed Height)	4 (43 ft ²)	1.71 (38.8 oz)	
	7 (75 ft ²)	3.00 (68 oz)	
	10 (107 ft ²)	4.28 (97 oz)	
	2.8 (9'2")	15 (161 ft ²)	6.17 (140 oz)
		20 (215 ft ²)	7.12 (161.5 oz)
		30 (322 ft ²)	8.73 (197.8 oz)
		50 (538 ft ²)	11.27 (255.3 oz)

Considerations for A2L Refrigerants

6

Where Category = R32, LFL = 0.306 kg/m³

Table GG.2 - Minimum Room Area (m²)

h ₀ (m)	Charge Limit (kg)	Min. Room Area (m ²)
(Installed Height)	0.5 (17.6 oz.)	1.82 (20 ft ²)
	0.67 (23.6 oz.)	2.43 (27 ft ²)
	1 (35.2 oz.)	3.63 (39 ft ²)
1.8 (6'0")	1.04 (36.6 oz.)	3.78 (41 ft ²)
	1.59 (56 oz.)	5.77 (63 ft ²)
	1.8 (63.4 oz.)	6.54 (70 ft ²)
2.5 (8'2")	2 (70.5 oz.)	7.26 (78 ft ²)
	0.5 (17.6 oz.)	1.31 (14 ft ²)
	0.67 (23.6 oz.)	1.75 (18 ft ²)
	1 (35.2 oz.)	2.61 (28 ft ²)
	1.04 (36.6 oz.)	2.72 (29 ft ²)
	1.59 (56 oz.)	4.16 (44 ft ²)
2.8 (9'2")	1.8 (63.4 oz.)	4.71 (50 ft ²)
	2 (70.5 oz.)	5.23 (56 ft ²)
	0.5 (17.6 oz.)	1.17 (12 ft ²)
	0.67 (23.6 oz.)	1.56 (16 ft ²)
	1 (35.2 oz.)	2.33 (25 ft ²)
	1.04 (36.6 oz.)	2.43 (26 ft ²)
1.59 (56 oz.)	3.71 (40 ft ²)	
	1.8 (63.4 oz.)	4.20 (45 ft ²)
	2 (70.5 oz.)	4.67 (50 ft ²)

The calculated minimum allowable room area for all capacities is therefore as follows:

Model (BTU)	Minimum Allowable Room Area (Assumes 25 ft lineset and 6 ft install height)
12,000	1.82 m ² (20 ft ²)
18,000	2.43 m ² (27 ft ²)
24,000	3.78 m ² (41 ft ²)
36,000	5.77 m ² (63 ft ²)

Table GG.3DV - Minimum Room Area (m²)

The standard factory refrigerant charge amount as well as the maximum allowable charge are as follows:



















Model (BTU)	R32 Refrigerant (Standard)	R32 Refrigerant (Max)
12,000	500 g / 1.1 lbs / (17.6 oz.)	575 g / 1.27 lbs / (20.2 oz.)
18,000	670 g / 1.48 lbs / (23.6 oz.)	745 g / 1.64 lbs / (26.2 oz.)
24,000	1040 g / 2.29 lbs / (36.6 oz.)	1165 g / 2.57 lbs / (41 oz.)
36,000	1590 g / 3.51 lbs / (56.1 oz.)	1815 g / 4 lbs / (64 oz.)

Table GG.4DV - Maximum Charge (g) [lbs]

! Determining Refrigerant Amount

Use the above figures when charging the system from empty. The proceeding pages will also inform the reader in determining the additional refrigerant charging amounts for adjusting the factory charge when using non-standard piping length.

Suggested Tools:

Tool	Illustration	Tool	Illustration	Tool	Illustration
Standard Wrench		Pipe Cutter		Vacuum Pump	
Adjustable/ Crescent Wrench		Screw Drivers (Phillips & Flathead)		Safety Glasses	
Torque Wrench		Manifold Gauge		Work Gloves	
Hex Keys or Allen Wrenches		Level		Refrigerant Scale	
Drill & Drill Bits		Flaring Tool		Micron Gauge	
Hole Saw		Clamp-On Amp Meter		Leak Detector	

Indoor Unit Installation Instructions

7

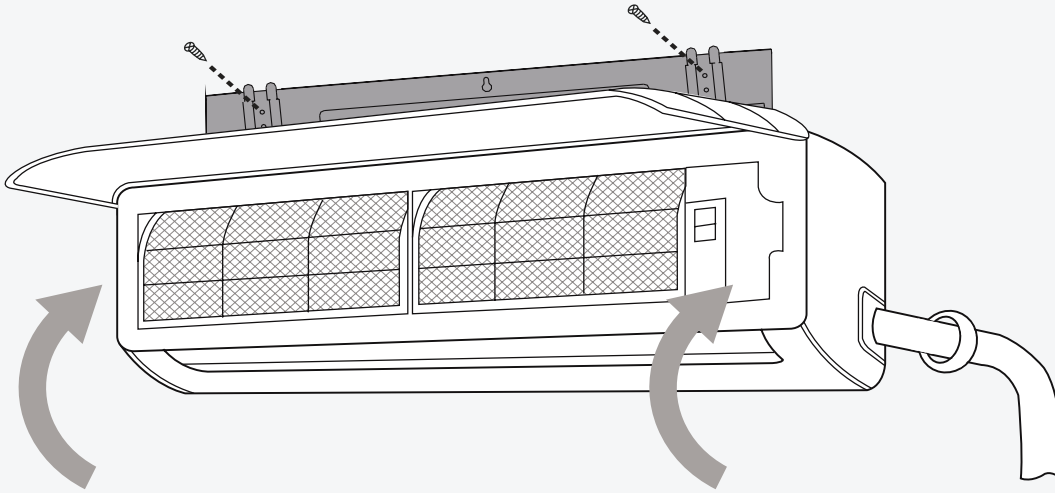

Installation Diagram

Before proceeding, it is important to consider the following height and length restrictions:

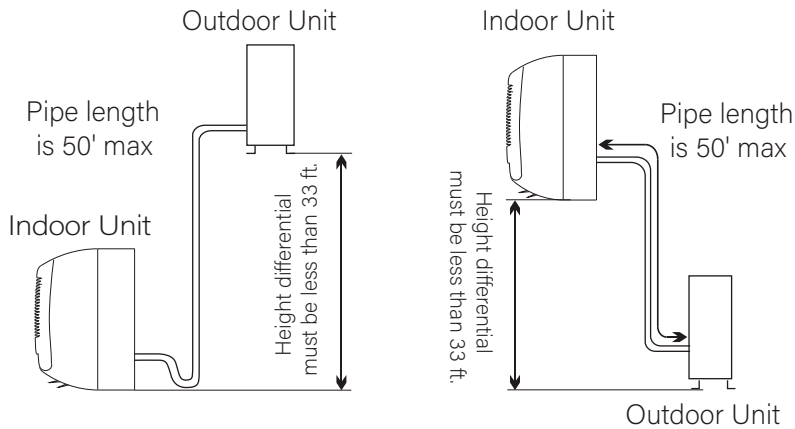

For Systems of 12K and 18K BTU:

- Follow the given constraints in the figures to the left.

For Systems of 24K and 36K BTU:

- The allowable **height differential** increases to 50 ft (24K) and 65 ft (36K).
- The allowable **pipe length** is 65 ft (24K) and 100 ft (36K).

Before starting the installation, decide on the position of both the indoor and outdoor units. Take into account the minimum clearance requirements for both the indoor and outdoor units, which can be found in their respective sections of this manual. Follow all required clearances.

Install the indoor unit inside the room to be air conditioned, avoiding corridors and communal areas. Install the indoor unit at a height such that the bottom of the indoor unit is at least 72 inches above the floor. Allow adequate space (4-6 inches, ideally 8 inches) above the air handler for return airflow.

NOTE

Only persons and/or companies qualified and experienced in the installation, service, and repair of refrigerant products should be permitted to do so. The purchaser must ensure the system is installed carefully and correctly.

Indoor Unit Installation Instructions

7

Indoor Unit Installation Location Selection

Follow the below best practices for selecting an optimal space for installation the indoor unit:

- **DO NOT** install the unit on a wall that is subject to vibrations.
- **DO NOT** install the system near sources of heat, steam, or flammable gases.
- **DO NOT** install the indoor unit in a location that is exposed to direct sunlight.
- **DO** ensure that the inlet and outlet vents are not obstructed. The system should be able to output air all across the room.
- **DO** minimize the distance between the indoor and outdoor unit and install the unit in a place where connecting the indoor and outdoor unit will be as simple as possible.
- **DO** install the unit on a strong wall and where it is easy to drain the condensate water.
- **DO** install the unit in a location where it will be easy to service the machine and perform any necessary maintenance.
- **DO** obey the following tolerances depicted in the illustration below:

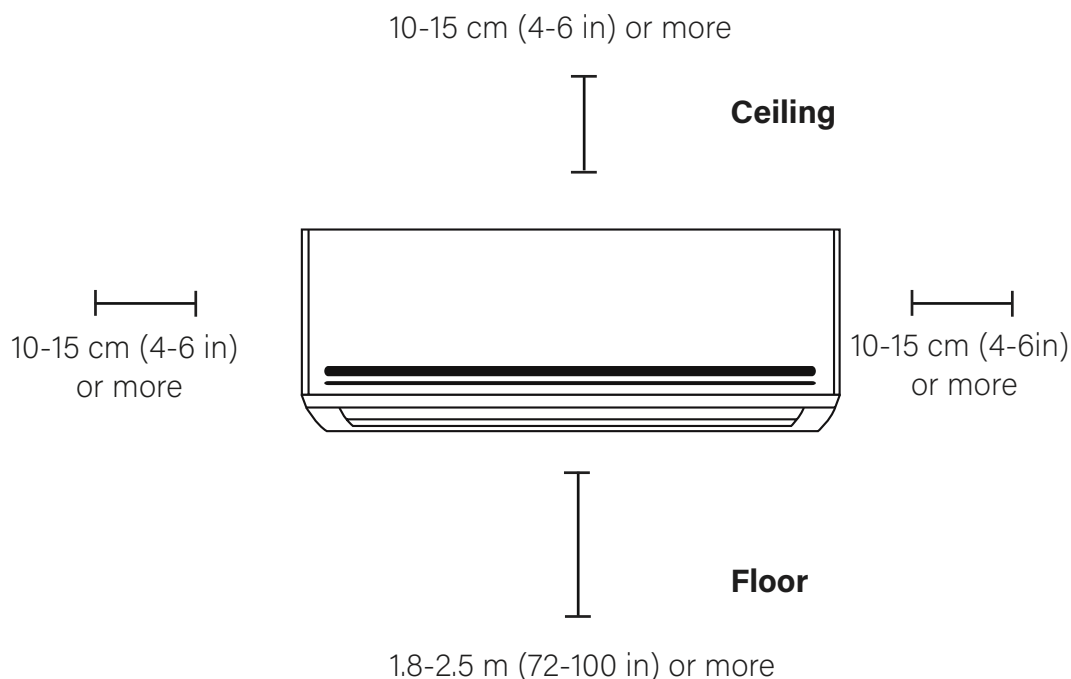

Indoor Unit Installation Instructions

7

Installation of the Mounting Plate

1. Dislodge the mounting plate from the rear of the indoor unit and place the mounting plate against the wall where the system will hang that fulfills the constraints on page 33. Use a level to ensure that the plate is horizontally and vertically level.
2. Drill 1-1/4" deep holes for each screw to enter. The locations are flexible but should be spaced well.
3. Insert the plastic anchors into each of the holes.
4. Fix the mounting plate to the wall by using the included tapping screws. Check that it is secured.

Note: The actual appearance of the mounting plate may differ slightly but the process is similar.

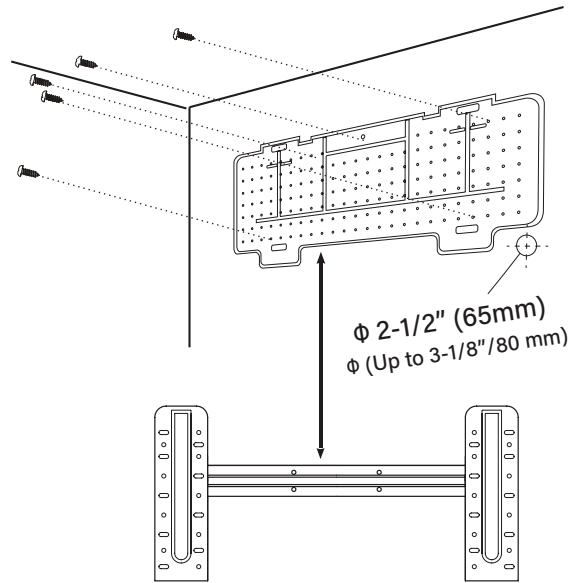

Ensure the mounting plate is firm and flat against wall

Drilling the Wall Hole for Piping

CHECK PAGES 54-55 FOR MOUNTING HOLE GUIDELINES ACCORDING TO THE BRACKET.

1. With the mounting plate firmly affixed to the wall, mount the indoor unit onto the mounting plate temporarily in order to confirm the location of the wall hole in the next steps.
2. Using a pencil, lightly trace the bottom corner of the indoor unit, depending on which side exit the piping will go through (see Page 36).
3. Take the inside unit off of the plate, and make a mark of where the hole will be (PG. 54-55), to ensure ample clearance between the tracing and bracket.
4. Drill a 2-1/2"~3-1/8" wall hole at a slight downward angle using a core drill, being careful to avoid wires, plumbing, and other sensitive materials. The bottom of the inside hole should be ~1/4" above the bottom of the outside hole.

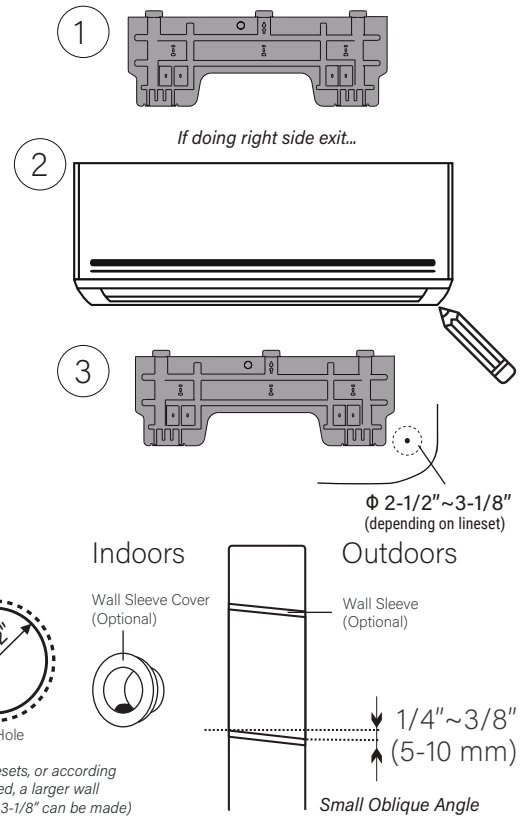

Indoor Unit Installation Instructions

7

Electrical Connections - Indoor Unit

All systems will include a wiring diagram affixed to the indoor unit. See **Page 38** for more details.

1. Lift up the front panel of the indoor unit.
2. Remove the cover as indicated in the illustration.
3. For the electrical wiring, consult the circuit diagram affixed to the electrical cover.
4. Connect the cables to the wiring terminal by following the numbering. Use wire gauge suitable for the electrical power input. (see name plate on the unit).

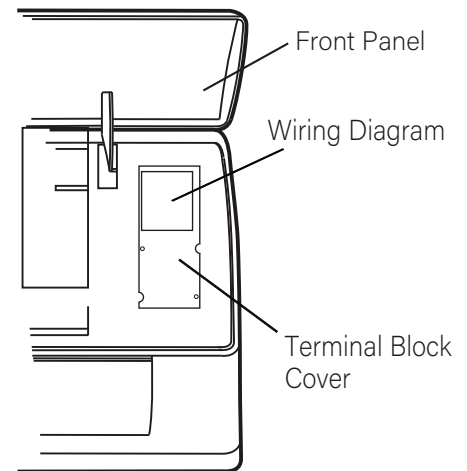

! BEFORE PERFORMING ELECTRICAL WORK, READ THESE REGULATIONS

1. All wiring must comply with local and national electrical codes, and must be installed by a licensed electrician.
2. All electrical connections must be made according to the Electrical Connection Diagram located on the panels of the indoor and outdoor units.
3. If there is a serious safety issue with the power supply, stop work immediately. Explain your reasoning to the client, and suspend all installation until the safety issue is properly resolved.
4. Power voltage should be within 90-110% of the range for the rated voltage. Insufficient power supply can cause malfunction, electrical shock, or fire.
5. Connect power through fixed wiring, install a surge protector and a disconnect switch box, and a dedicated circuit breaker with a capacity of 1.5 times the maximum current of the unit.
6. A properly rated HACR-type fuse or circuit breaker that disconnects all poles and that has a contact separation of at least 1/8in (3mm) must be incorporated in the fixed wiring. The qualified technician must use an approved circuit breaker or fuse.
7. Only connect the unit to an individual branch circuit. Do not connect another appliance to that outlet. This equipment requires its own dedicated and protected circuit.
8. Make sure to properly ground the air conditioner. The use of a surge protector is recommended.
9. Every wire must be firmly connected. Loose wiring can cause the terminal to overheat, resulting in product malfunction and possible fire.
10. Do not let wires touch or rest against refrigerant tubing, the compressor, or any moving parts within the unit.



WARNING: BEFORE PERFORMING ANY ELECTRICAL OR WIRING WORK, TURN OFF THE MAIN POWER TO THE SYSTEM. NOTE MULTIPLE POWER SOURCES MAY EXIST.

Indoor Unit Installation Instructions

7

Preparing the Refrigerant Piping of the Indoor Unit

The piping "pigtails" pre-attached to the indoor unit can be run in 3 different ways as shown in the illustration. Decide which type of configuration is most suitable before continuing.

By default it is routed for a left side exit as shown in #1. This method can either use the left side knockout for a side exit, or a wall hole can be drilled on the left side of the unit's rear.

Routing it straight through the back of the system (#2) will facilitate the connections to the copper pipe extensions to be made outside. This is recommended to simplify the process.

#3 is a right side exit, but is not recommended as it involves a 180° bend of the piping, which increases the risk of kinking or collapsing the lines dramatically. Bend slowly and cautiously.

If a side-exit is chosen, there are knock-out panels on either side of the unit that can be cut out along the groove to provide a notch for the pipe to exit from. Use a suitable cutter to do this.

For the method chosen, run the piping in the direction of the wall hole. Bind the copper pipes, drain pipe, and power cables together with tape, with the drain pipe at the bottom so that water can flow freely. **Ensure that the bundle is exiting at a continuous downward pitch.**

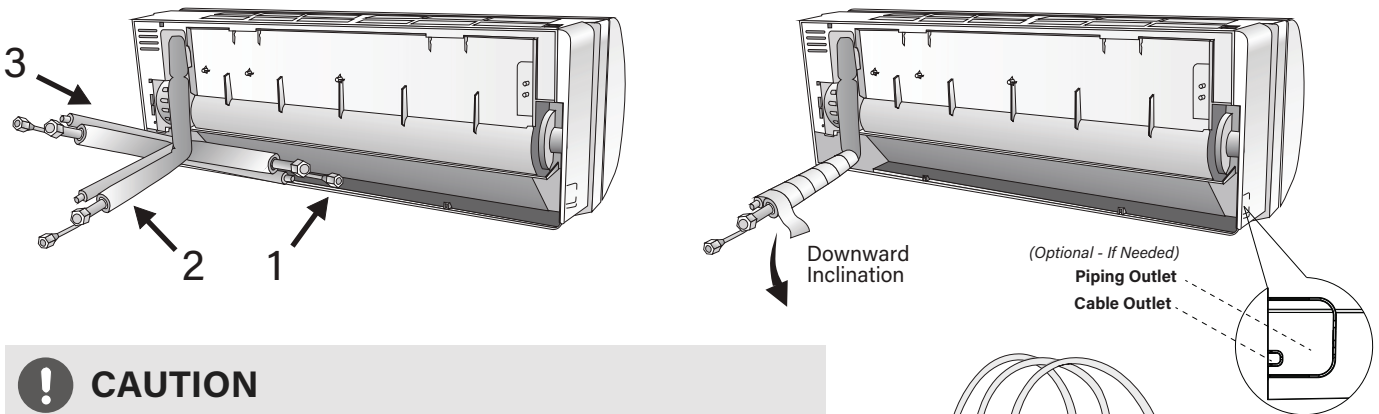

! CAUTION

- Do not remove the seal caps from the pipe ends until it is time to connect it, to avoid contaminants from entering.
- If the pipe is bent/pulled too often, it will become stiff. Don't bend the pipe more than three times at one point. Be extremely careful not to kink any piping.
- When extending the coiled copper pipes, straighten them by unwinding gently, as shown in the picture.

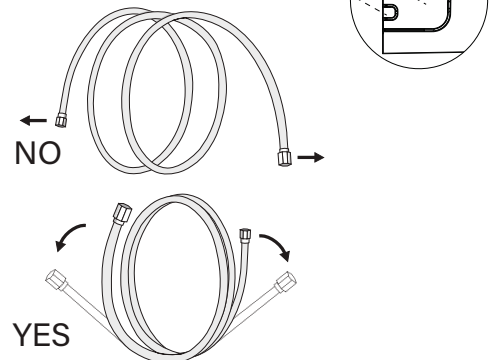

Unwind the coil gently against a flat surface, rather than pulling at ends.

Connecting the Drain Hose

By default, the drain hose is attached to the left-hand side of unit ("left" when facing the back of the unit). However, it can also be attached to the right-hand side.

1. To ensure proper drainage, attach the drain hose on the same side that your refrigerant piping exits the unit.
2. Attach any drain hose extensions (sold separately) to the end of drain hose.
3. Wrap the connection point of the drain hose firmly with Teflon tape to create a good seal, and to prevent leaks.
4. For the portion of the drain hose that will remain indoors, wrap it with foam pipe insulation to prevent condensation.
5. Remove the air filter and pour a small amount of water into the drain pan to make sure that water flows away from the unit smoothly.

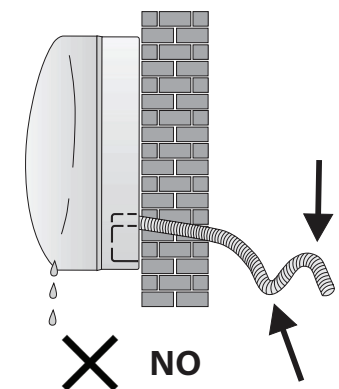
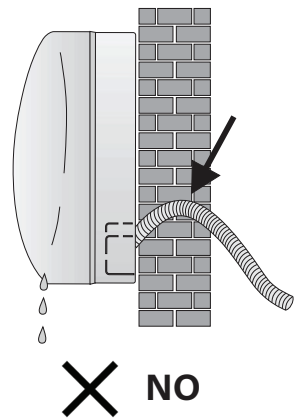
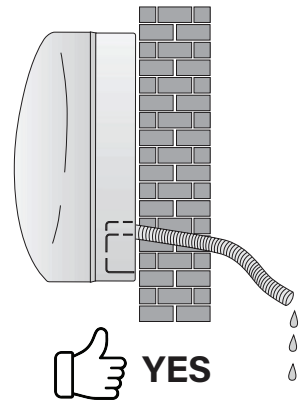

NOTE ON DRAIN HOSE PLACEMENT

Make sure to arrange the drain hose according to the illustrations.

- ⊘ **DO NOT** kink the drain hose.
- ⊘ **DO NOT** create a water trap (siphon).
- ⊘ **DO NOT** put the end of the drain hose in water or in a container that will collect water.

DUAL DRAIN HOLE LOCATIONS EXIST

The indoor unit has 2 drain connections on left and right sides. Either one can be utilized. One side will have a hose connected, while the other is plugged.

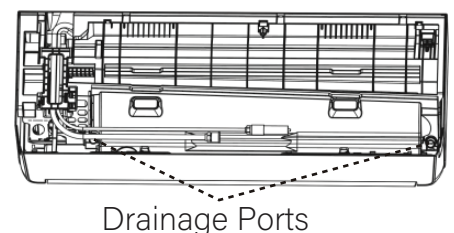

Indoor Unit Installation Instructions

7

Connecting the Signal Cable

Color selection does not matter as much as matching number to number does. Consult the diagram affixed to the indoor and outdoor unit respectively for specific wiring instructions. There are 3 terminals (1, 2, 3) and ground (G). Do not mix up the wires between each ends. **It is vital** that the colors between the indoor and outdoor unit match for each terminal. A simplified wiring diagram is included in the Appendix section of this manual. On the indoor unit, the wiring diagram is located underneath the front panel as shown below:

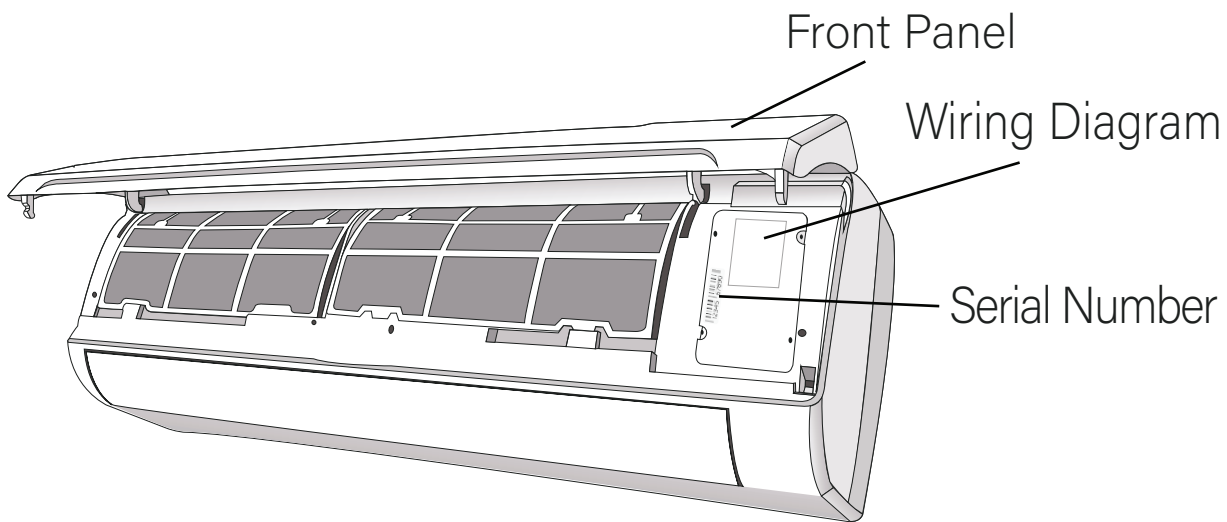

Cable Wire Specifications (For Common Configurations)

Pioneer WYT-17 Series Mini Split		12K/115V	12K/230V	18K	24K	36K
		Section Area (AWG)				
Power Supply Cable	N(L2)					
	L(L1)	12 AWG	14 AWG	12 AWG	12 AWG	10 AWG
Connection Cable for Communication Between Indoor and Outdoor Units	3(L)	16 AWG	16 AWG	16 AWG	16 AWG	16 AWG
	2(N)					
	1(S)					

Consult the nameplate on the system for detailed electrical specifications. Confirm wiring on **Page 42**. Above power wire sizes assume largest allowable fuse.

- 115V systems take a single-pole breaker for the main circuit panel
- 230V require a double-pole breaker (tandem-type will not work)



Single-Pole
115V Breaker



Double-Pole
230V Breaker

Indoor Unit Installation Instructions

7

Connecting the Refrigerant Piping to the Indoor Unit

Once the copper piping kit coil is unwound, refer to the below instructions to proceed:

1. Bring the ends of both the copper line and the indoor unit line together. Align the centers of the pipes that will be connected.
2. Remove the indoor unit piping cap, and check that no debris is inside. Some gas may be heard escaping, but it is dry nitrogen to keep lines clean.
3. Use any leak guard and/or flare sealers on the flares of the piping if available. Attach the flare nut and tighten as much as possible by hand. Torque correctly to the specifications found in the table below using two wrenches. Repeat the process for the other copper line.

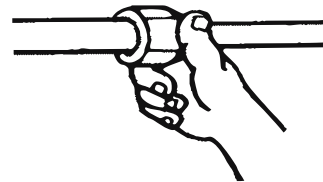
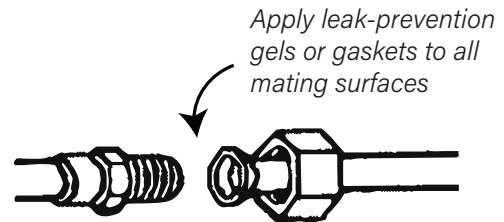

Torque Wrench

TIGHTENING TORQUE FOR PROTECTION CAPS AND FLANGE CONNECTION

Pipe Diameter	Tightening Torque [N x m]	Tightening Torque (ft-lbf)	Corresponding Stress (using a 20 cm wrench)	TIGHTENING TORQUE [N x m] (ft-lbf)	
Φ 1/4" (6.35 mm)	15 - 20	11 - 15	Wrist Strength	Service Port Nut	[7 - 9] (5-7)
Φ 3/8" (9.52 mm)	31 - 35	23 - 26	Arm Strength	Protection Caps	[25 - 30] (18-22)
Φ 1/2" (Φ 12 mm)	45 - 50	33 - 37	Arm Strength		
Φ 5/8" (15.88 mm)	60 - 65	44 - 48	Arm Strength		

Wrapping the Lines and Mounting the Indoor Unit

For mounting the indoor unit, proceed as follows:

1. Arrange the pipes, cables, and drain hose well.
2. Lag the pipe joints with insulation material, and secure with vinyl tape as depicted in the figure.
3. Run the bound bundle through the wall hole, and mount the indoor unit securely onto the mounting plate. Press/push the lower part of the indoor unit so it clicks onto the mounting plate.

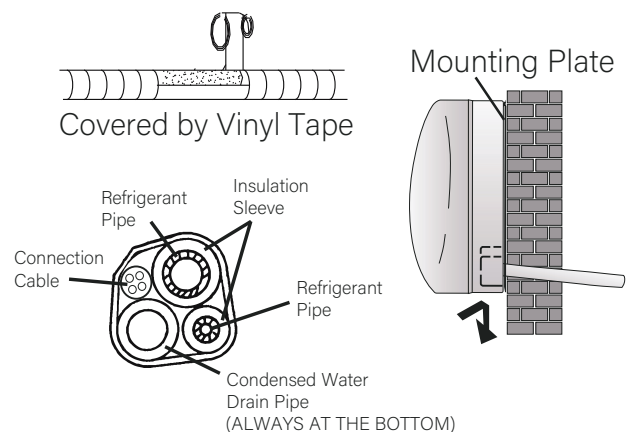

Outdoor Unit Installation Instructions

8

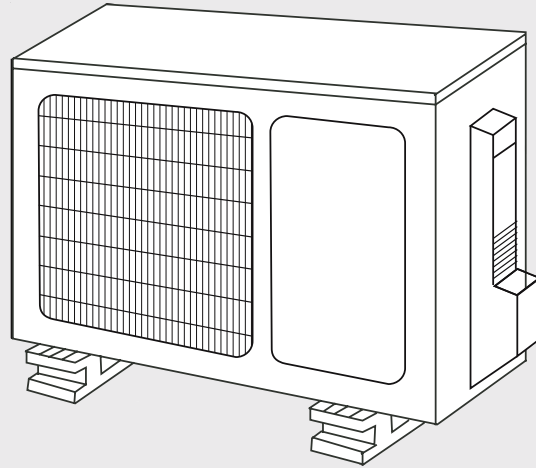

Mounting the Outdoor Unit to the Selected Location

The outdoor unit should be installed either on a pad or on a solid wall using suitable mounting brackets and fastened securely. Follow the procedure below before connecting any pipes or cables:

- Decide what the best position on the wall or on the ground is, and leave enough space to be able to carry out maintenance easily. Anchoring dimensions are provided on **Page 53**.
- If wall mounting, fasten the support brackets to the wall using hardware that is particularly suited for the type of wall. Use the appropriate amount of hardware for the application.
- The unit must be installed following all national regulations.

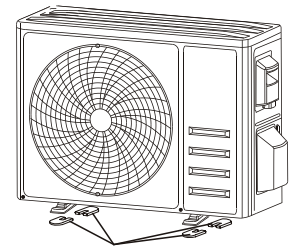

Install 4 rubber pads (Optional)

Outdoor Unit Condensate Water Drainage

The condensate water and the ice formed in the outdoor unit during heat mode can be directed away using the drain joint and drain pipe included with the system. This is optional and only needed if the default configuration of water drainage out from the port on the bottom side is not desired.

1. Fasten the drain port in the 1 inch port located in the part of the unit depicted in the diagram.
2. Connect the drain port and the drain pipe.
3. Ensure the condensate will drain to a suitable place.

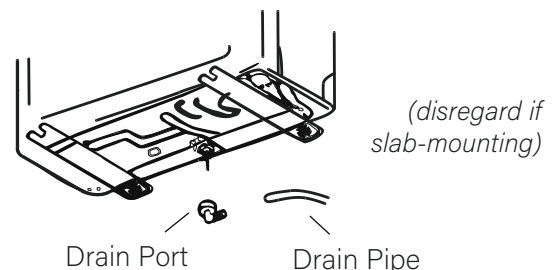

Outdoor Unit Installation Location Selection

Follow the below best practices for selecting an optimal space for installation the indoor unit:

- **DO NOT** install the unit near sources of heat, steam, or flammable gases.
- **DO NOT** install the system in areas prone to extreme winds or dust.
- **DO NOT** install the outdoor unit in an area that has many passersby.
- **DO** select a location where the air discharge and operating sound level will not disturb others.
- **DO** install the system in a shaded area or utilize a cover/sun protection that will not interfere with air flow. This will also protect the system from heavy rain or snow.
- **DO** install the unit in a safe and sturdy location.
- **DO** install rubber vibration absorbers if the system can induce vibrations in any structure.
- **DO** obey the following tolerances depicted in the illustration below to ensure air flow:

Minimum Required Installation Space

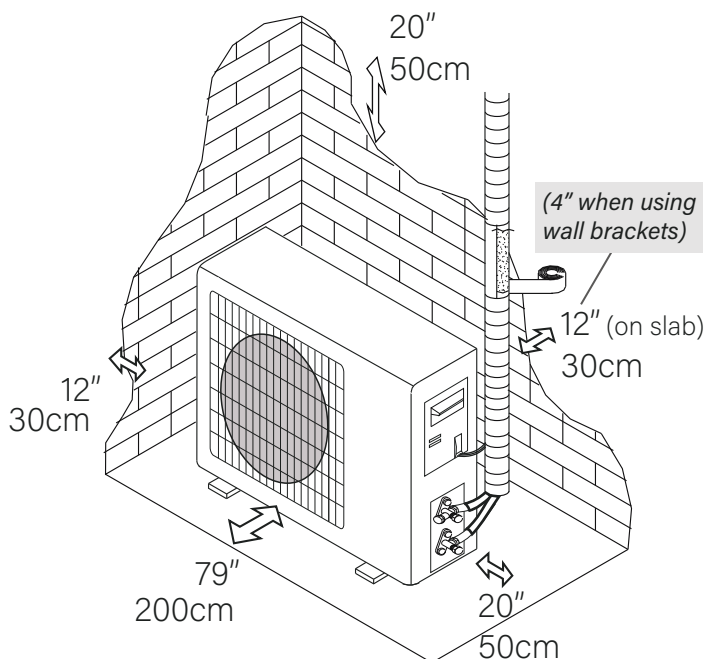

SPECIAL CONSIDERATIONS FOR EXTREME WEATHER CONDITIONS

If the unit is exposed to heavy wind: Install unit so that air outlet fan is at a 90° angle to the direction of the wind. If needed, use wind baffles or build a barrier in front of, but sufficiently away from, the unit to protect it from extremely heavy winds.

FOR BEST LONGEVITY AND PERFORMANCE IN PRECIPITATION/AIRFLOW/SALTY AIR

If the unit is frequently exposed to heavy rain or snow: Build a shelter above the unit to protect it from the rain or snow. Be careful not to obstruct air flow around the unit. If the unit is frequently exposed to salty air (seaside air): Use specifically approved anti-corrosion coating sprays onto the heat exchanger surface in order to resist corrosion.

Outdoor Unit Installation Instructions

8

BEFORE PERFORMING ANY ELECTRICAL WORK, READ THESE REGULATIONS

1. All wiring must comply with local and national electrical codes, and must be installed by a licensed electrician.
2. All electrical connections must be made according to the Electrical Connection Diagram located on the side panels of the indoor and outdoor units.
3. If there is a serious safety issue with the power supply, stop work immediately. Explain your reasoning to the client, and suspend all installation of the unit until the safety issue is properly resolved.
4. Power voltage should be within 90-110% of rated voltage range. Insufficient power supply can cause electrical shock or fire.
5. Connect power through fixed wiring, install a surge protector*, and disconnect switch box. Use a dedicated circuit breaker with a capacity of 1.5 times the maximum current of the unit.
6. A properly rated HACR-type fuse or circuit breaker that disconnects all poles and has a contact separation of at least 1/8in (3mm) must be incorporated in the fixed wiring. The qualified technician must use an approved circuit breaker or switch.
7. Only connect the unit to a dedicated individual branch circuit breaker. Do not connect another appliance to that same circuit.
8. Be sure to properly ground the air conditioner.
9. Every wire must be firmly connected. Loose wiring can cause the terminal to overheat, resulting in product malfunction and possible fire.
10. Do not let wires touch or rest against refrigerant tubing, the compressor, or any other moving parts within the unit.

**optional, highly recommended.*

WARNING

BEFORE PERFORMING ANY ELECTRICAL OR WIRING WORK, TURN OFF THE MAIN POWER SOURCE, OR SOURCES, TO THE SYSTEM.

1. Prepare the cable for connection:

USE THE RIGHT CABLE

- Outdoor Power Cable: THHN or THWN
- Signal Cable: TC-ER or better (AWG #16)

Minimum Cross-Sectional Area of Power and Signal Cables

North America

Circuit Breaker Size (A)	Wire Size (AWG)
10	18
13	16
15	14
20	12
30	10

INDOOR UNIT TERMINAL POSITION #1 connects to OUTDOOR UNIT TERMINAL POSITION #1.

INDOOR UNIT TERMINAL POSITION #2 connects to OUTDOOR UNIT TERMINAL POSITION #2.

INDOOR UNIT TERMINAL POSITION #3 connects to OUTDOOR UNIT TERMINAL POSITION #3.

INDOOR UNIT TERMINAL POSITION "GROUND" connects to OUTDOOR UNIT GROUNDING LUG

Using wire strippers, strip the rubber jacket from both ends of cable to reveal about 40mm (1.5 in) of the wires inside. Strip the insulation from the ends of the wires. Using a wire crimper, crimp u-lugs on the ends of the wires. Note that some cables come with preinstalled u-lugs from factory.

Power/Signal Electrical Wiring to the Outdoor Unit

On the outdoor unit, the wiring diagram is located in the inner side of the handle cover.

The outside unit's terminal block is protected by an electrical wiring cover on the side of the unit. A comprehensive wiring diagram is printed on the inside of the wiring cover.

1. Unscrew and remove the handle on the right side plate of the outdoor unit.
2. Wire the system using the appropriate gauge wire found on page 38/42 and the wiring diagram found on the handle cover. See page 55 for more details.
3. Use proper flexible rain-tight conduit with appropriate size connectors.
4. Fasten the power connection wires into place using the supplied wire clamps.
5. Check the wiring against the diagram to ensure it is wired correctly. A proper ground must be established.
6. Rescrew and reinstall the cover handle.

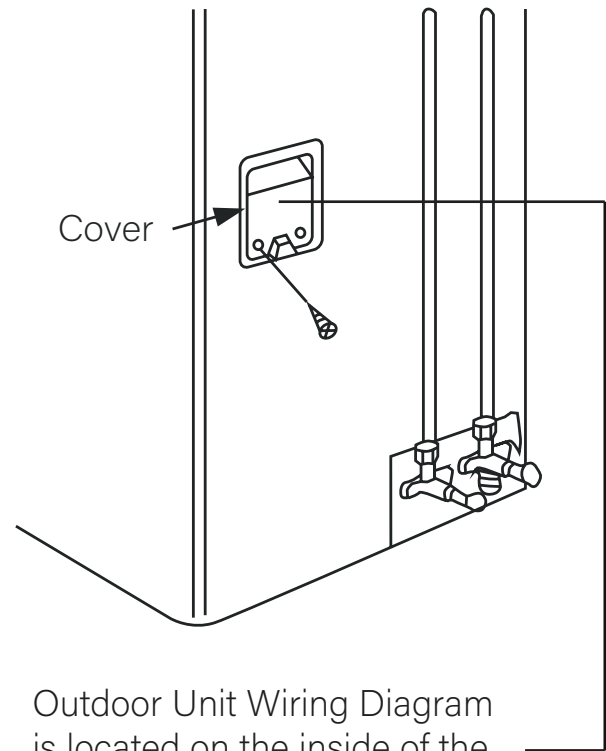

Outdoor Unit Wiring Diagram is located on the inside of the wire cover on the outdoor unit.

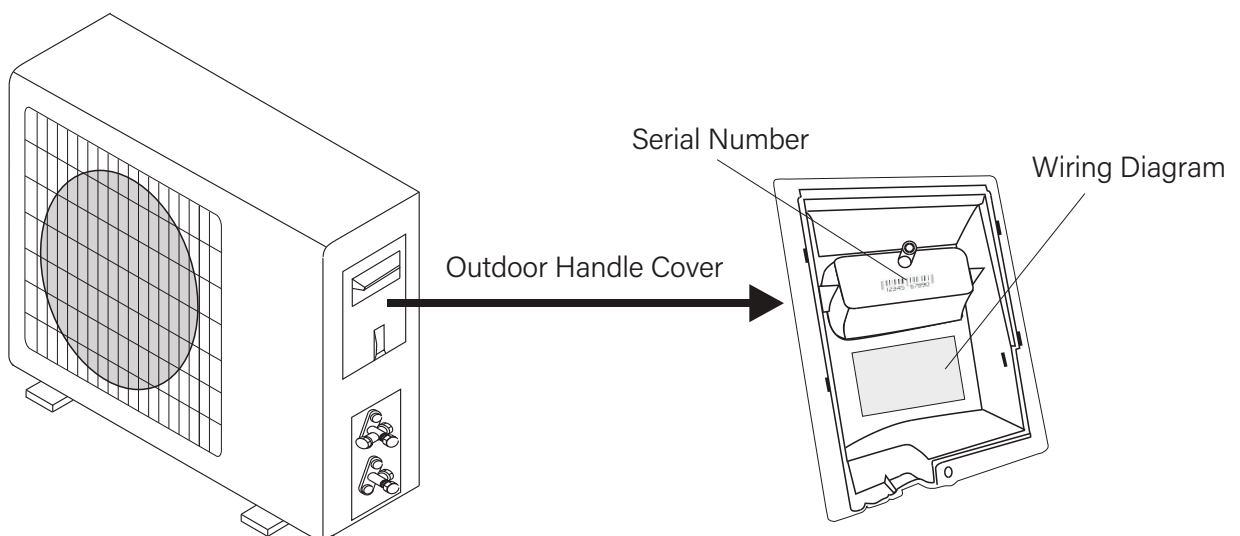

Outdoor Unit Installation Instructions

8

Connection of the Refrigerant Piping

The length of refrigerant piping will affect the performance and energy efficiency of the unit. Nominal efficiency is tested on units with a pipe length of 16 ft. Factory precharge is sufficient for supporting up to 25 ft of connected lineset. Piping should not be shorter than 10 ft in length. Refer to the table below for specifications on the maximum length and drop height of piping. If the factory precharge is modified, make a note of the charge modification amount on Page 59.

Pioneer WYT-17 Series Mini Split MODEL / Capacity (BTU/h)	12K BTU	18K BTU	24K BTU	36K BTU
Liquid Pipe Diameter	Φ 1/4" (6.35 mm)	Φ 1/4" (6.35 mm)	Φ 1/4" (6.35 mm)	Φ 1/4" (6.35 mm)
Gas Pipe Diameter	Φ 3/8" (9.52 mm)	Φ 3/8" (9.52 mm)	Φ 1/2" (12 mm)	Φ 5/8" (15.88 mm)
Maximum Length of Pipe with Standard Charge	25 ft / 7.5m	25 ft / 7.5m	25 ft / 7.5m	25 ft / 7.5m
Maximum Distance Between Indoor and Outdoor Unit	50 ft / 15m	50 ft / 15m	65 ft / 20m	100 ft / 30m
Adjustment Refrigerant Charge (For each add'l foot after 25 ft.)	0.11oz/ft 10g/m			
Max. Difference in Level Between Indoor and Outdoor Unit	33 ft / 10m	33 ft / 10m	50 ft / 15m	65 ft / 20m
Type of Refrigerant	R32			

Connection Instructions - Refrigerant Piping

Step 1: Cut pipes (If cutting lineset shorter)*

When preparing refrigerant pipes, take extra care to cut and flare them properly. This will ensure efficient operation and minimize the need for future maintenance.

1. Measure the distance between the indoor and outdoor units.
2. Using a rolling blade type pipe cutter, cut the pipe a little longer than the measured distance.
3. Make sure that the pipe is cut at a perfect 90° angle. Refer below for bad cut examples:

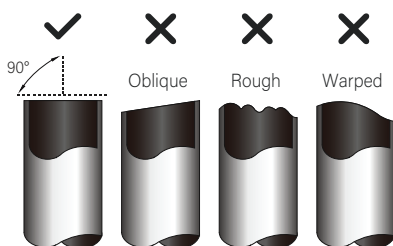

*Most standard linesets are pre-flared. In case modifications are needed.

! DO NOT DEFORM PIPE WHILE CUTTING

Be extra careful not to damage, kink, or deform the pipe while cutting. This will drastically reduce the efficiency and capacity of the unit and may cause internal damage.

Step 2: Remove any burrs carefully.

Burrs can affect the air-tight seal of refrigerant piping connection. They must be completely removed. Follow these steps for proper deburring:

1. Hold the pipe at a downward angle to prevent burrs from falling into the pipe.
2. Using a reamer or deburring tool, remove all burrs from the cut section of the pipe.

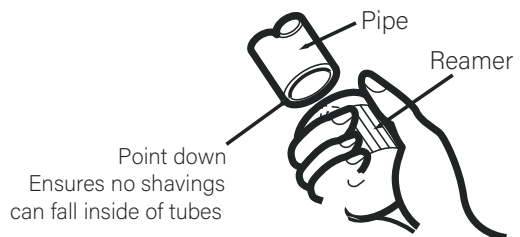

Step 3: Flare pipe ends

Proper flaring is essential to achieve an airtight seal.

1. After removing burrs from cut pipe, seal the ends with PVC tape to prevent foreign materials from entering the pipe.
2. Sheath the pipe with insulating material.
3. Place flare nuts on both ends of pipe. Make sure they are facing the correct direction, because they cannot be put on or have their direction changed after flaring.

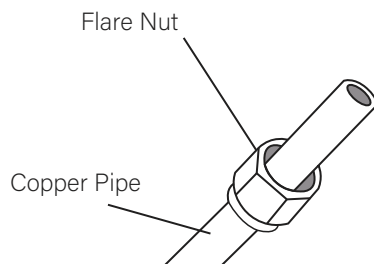

4. Remove PVC tape from ends of pipe when ready to perform flaring work.
5. Clamp flare form on the end of the pipe. The end of the pipe must extend beyond the edge of the flare form in accordance with the dimensions shown in the following table:

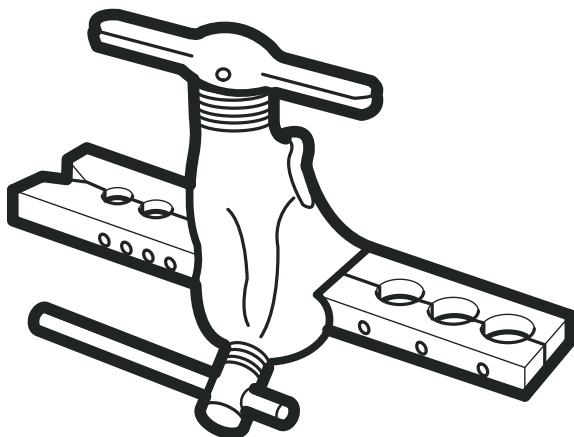

PIPING EXTENSION BEYOND FLARE FORM

Outer Diameter of Pipe (mm)	A (mm)	
	Min.	Max.
Ø 6.35 (Ø 1/4")	0.7 (0.03")	1.3 (0.05")
Ø 9.52 (Ø 3/8")	1.0 (0.04")	1.6 (0.06")
Ø 12.7 (Ø 1/2")	1.0 (0.04")	1.8 (0.07")
Ø 16 (Ø 5/8")	2.0 (0.08")	2.2 (0.09")
Ø 19 (Ø 3/4")	2.0 (0.08")	2.4 (0.1")

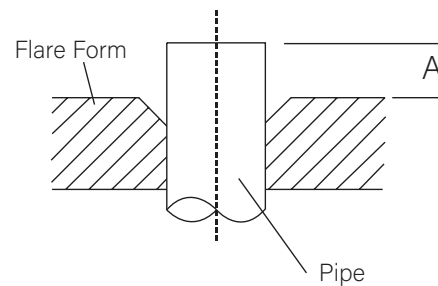

6. Place flaring tool onto the form.
7. Turn the handle of the flaring tool clockwise until the pipe is fully flared.
8. Remove the flaring tool and flare form, then inspect the end of the pipe for cracks and successful, even flaring.

Step 4: Connect pipes

When connecting refrigerant pipes, be careful not to use excessive torque, or to deform the piping in any way. One should first connect the low-pressure pipe, then the high-pressure pipe.

If provided by the supplier, apply leak guard material on all flared mating surfaces. Do **NOT** use any plumbing or putty sealants.

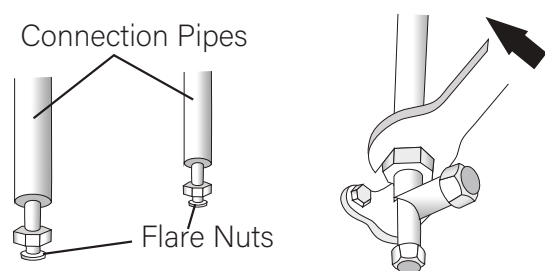

Outdoor Unit Installation Instructions

8

Instructions for Connecting Piping to Outdoor Unit

1. Unscrew the cover from the packed valve on the side of the outdoor unit.

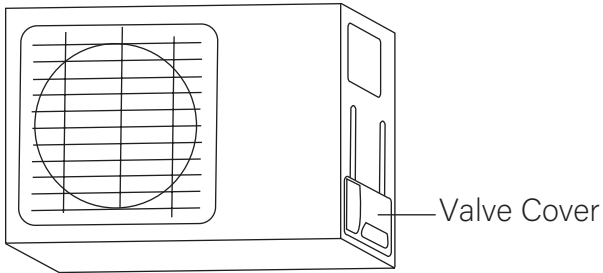

2. Remove protective caps from the valve ends.
3. Align flared pipe end with each valve, and tighten the flare nut as tightly as possible by hand.
4. Using a spanner, grab the body of the valve. Do not grab the nut that seals the service valve.

! USE SPANNER TO GRAB THE BODY OF THE SERVICE VALVE

Torque from tightening the flare nut can snap off other parts of valve.

5. While firmly gripping the body of the valve, use a torque wrench to tighten the flare nut according to the correct torque values.
6. Loosen the flaring nut slightly, then tighten again.
7. Repeat Steps 3 to 6 for the remaining pipe.

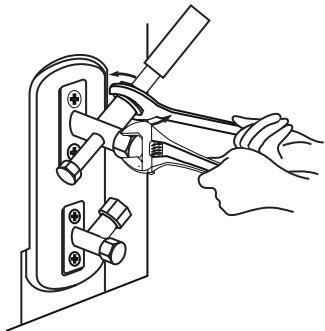

MINIMUM BEND RADIUS

When bending connective refrigerant piping, the minimum bending radius is 10 cm (4").

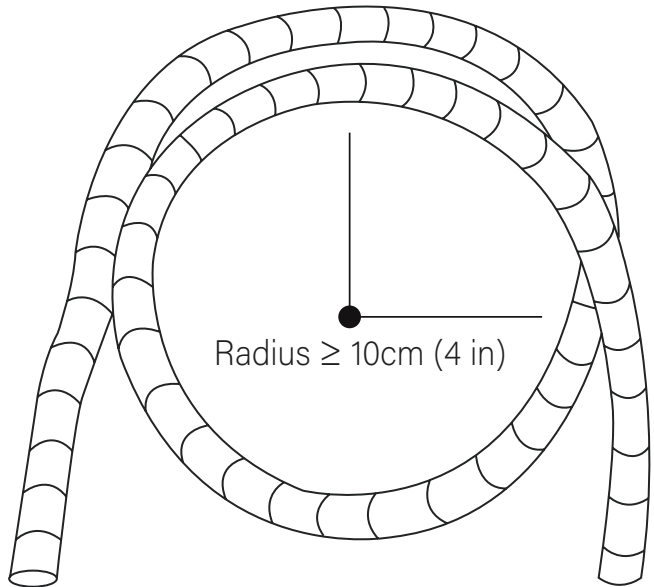

! DO NOT USE EXCESSIVE TORQUE

Excessive force can break the nut or damage the refrigerant piping. You must not exceed the torque requirements shown in the table shown on page 39.

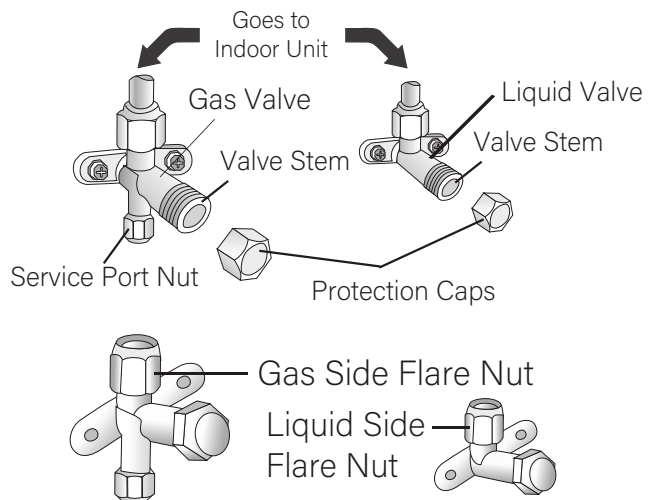

Air Evacuation and Bleeding the Circuit

The air and/or humidity left inside the refrigeration circuit can contaminate the refrigerant and cause abnormal spikes in pressure, leading to eventual compressor malfunction. Therefore, after having connected the indoor and outdoor units to create a closed system, it is necessary to bleed the air and humidity out of the circuit through the use of a vacuum pump.

Evacuation should be performed upon initial installation or when the unit is relocated. For first time installations, **do not** prematurely release the refrigerant prior to evacuation. Keep valve caps sealed.

BEFORE PERFORMING EVACUATION

- ✓ Check to make sure that both high-pressure and low-pressure pipes between the indoor and outdoor units are connected properly in accordance with the "Refrigerant Piping Connection" section of this manual.
- ✓ Check to make sure all wiring is connected properly and is fully enclosed and insulated.

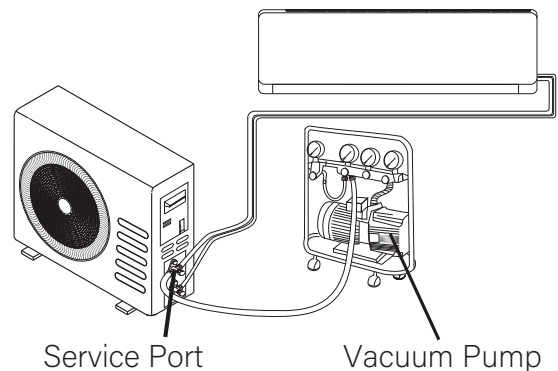

Evacuation Instructions

Before using a vacuum pump and manifold gauge, read their operation manuals to become familiarized with using them properly.

- 1) Remove the caps from the 2-way and 3-way valves (**do not** manipulate valves until Step 11).
- 2) Unscrew and remove the cap from the service port (see diagram on right side).
- 3) Connect the blue (low) hose of the manifold gauge to service port on the outdoor unit's 3-way valve (use an adapter if needed). **Ensure that the pin fully engages the schrader valve.**
- 4) Connect the yellow (middle) hose from the manifold gauge to the vacuum pump.
- 5) Open the low pressure knob of the manifold gauge. Keep the high pressure knob closed.

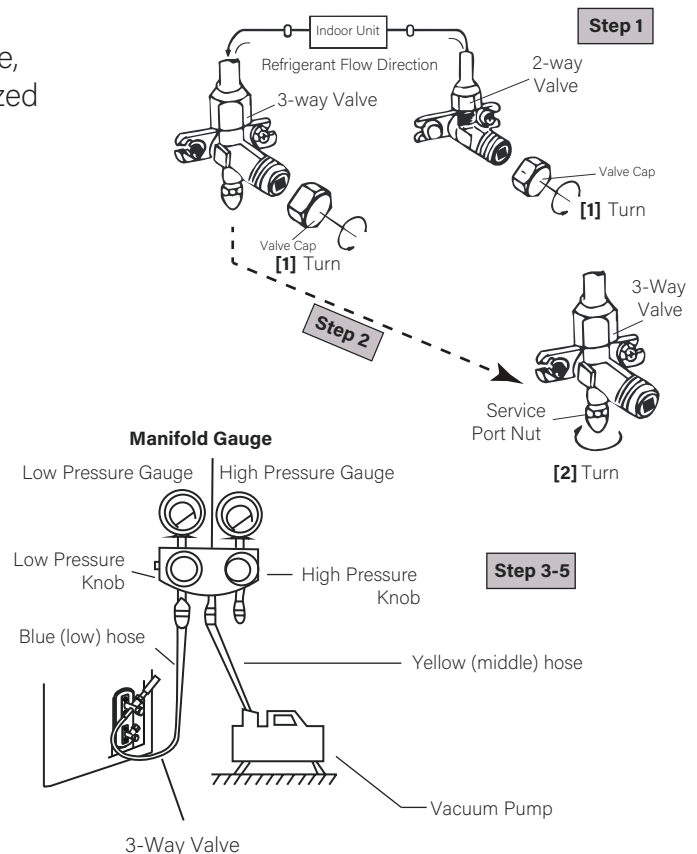

Outdoor Unit Installation Instructions

8

Evacuation Instructions (Cont'd)

- Turn on the vacuum pump to evacuate the system.
- Run the vacuum for at least 15 minutes, or until the Compound Meter reads -76cmHG (-100 kPa or -30 inHg). The vacuum reading should gradually lower.
- Close the low pressure knob of the manifold gauge, and turn off the vacuum pump.
- For best results, wait for at least 1 hour, then verify that there has been no rise in the vacuum reading.
- If there is a rise in the system vacuum, refer to "Gas Leak Check" section for information on how to check for leaks. If no change in vacuum reading, unscrew the cap from the service valve (high pressure valve).
- Insert the Allen wrench into the service valve (2-way valve) and open the valve by turning the wrench in a 1/4 counterclockwise turn. Wait and listen for gas to exit the system, then close the valve after 5 seconds. *(If no sound is heard or change in reading occurs, refer to page 52.)*
- Watch the pressure gauge for a few minutes to make sure that there is no drop in pressure. The Gauge should now show a positive reading. From this point, it is best to do a leak check using soapy water spray.
- If no leaks, remove the charge hose from the service port.
- Using a hexagonal wrench, fully open both the high pressure and low pressure valves counterclockwise.
- Tighten valve caps on all three valves (service port, high pressure, low pressure) by hand. Tighten further using a torque wrench if needed.

Do not open either of these valves until evacuation steps are completed and system is ready for startup (steps 11-15)

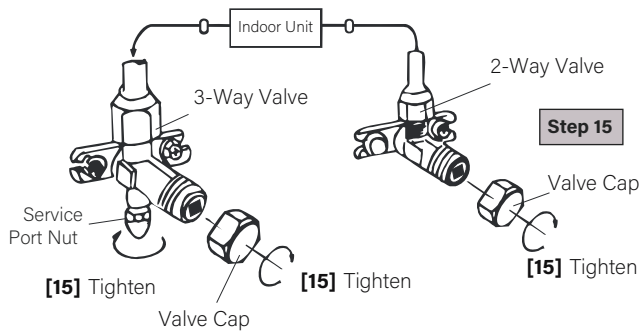
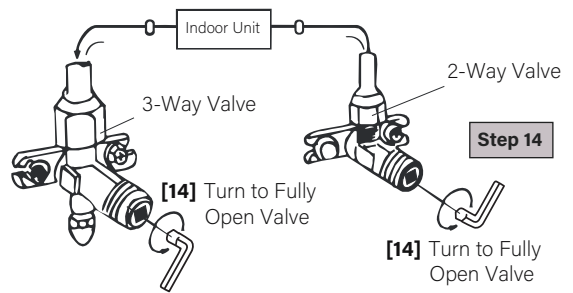
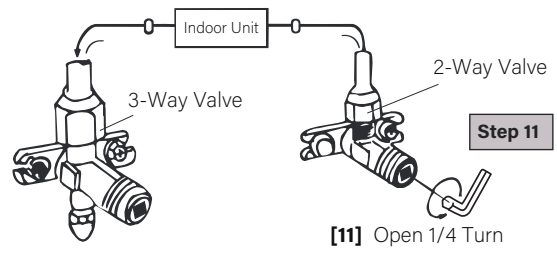
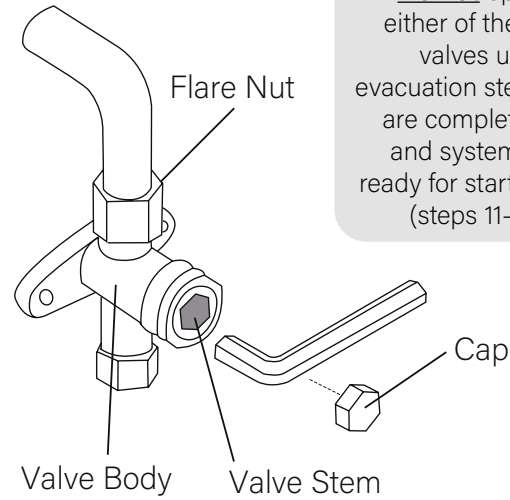

! OPEN VALVE STEMS GENTLY

When opening valve stems, turn the supplied Allen wrench until the valve stem comes into contact with stopper. **Do not** try to force the valve to open further.

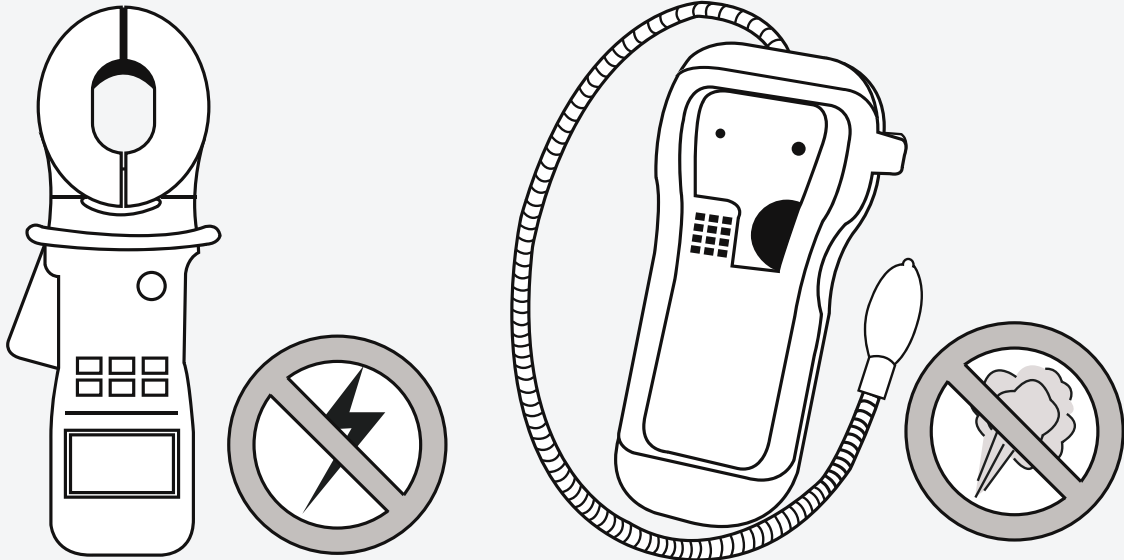

ELECTRICAL SAFETY CHECKS

After installation, confirm that all electrical wiring is installed in accordance with local and national regulations, and according to the Installation Manual.

BEFORE TEST RUN

- Check Grounding Work
- Measure grounding resistance by visual detection or with a grounding resistance tester. Grounding resistance must be less than 4Ω.
Note: This may not be required in some locations.

DURING TEST RUN

- Check for Electrical Leakage
- During the Test Run, use an electroprobe and multi-meter to perform a comprehensive electrical leakage test.
- If electrical leakage is detected, turn off the unit immediately and call a licensed electrician to find and resolve the cause of the leakage.
Note: This may not be required in some locations.

WARNING - RISK OF ELECTRIC SHOCK

ALL WIRING MUST COMPLY WITH LOCAL AND NATIONAL ELECTRICAL CODES, AND MUST BE INSTALLED BY A LICENSED ELECTRICIAN.

GAS LEAK CHECKS

There are 2 methods to check for gas leakage:

- Soap and Water Method**
Using a soft brush, apply soapy water or liquid detergent to all pipe connection points on the indoor unit and outdoor unit. The presence of bubbles indicates a leak.
- Leak Detector Method**
If using leak detector, refer to the device's operation manual for proper usage instructions.

AFTER PERFORMING GAS LEAK CHECKS

After confirming that the all pipe connection points DO NOT leak, replace the valve cover on the outside unit.

Electrical/Gas Leak Check and Test Run

9

Test Run

BEFORE TEST RUN

Only perform a test run after the following steps have been completed:

- ✓ **Electrical Safety Checks**
Confirm that the unit's electrical system is safe and is operating properly.
- ✓ **Gas Leak Checks**
Check all flare nut connections and confirm that the system is not leaking.
- ✓ **Opened Valves**
Confirm that both the gas and liquid valves (high/low) are 100% fully opened. ↻

TEST RUN INSTRUCTIONS

The following test run should be performed for 30 minutes:

1. Connect power to the unit.
2. Press the ON/OFF button on the remote controller to turn it on.
3. Press the MODE button to scroll through the following functions, one at a time:
 - COOL – Select lowest possible temperature
 - HEAT – Select highest possible temperature
4. Let each function run for 5 minutes, and perform the following checks:

PASS/FAIL?

- No Electrical Leaks or Abnormal Noises
- Unit is Properly Grounded
- All Electrical Terminals Properly Covered
- Indoor and Outdoor Units Securely Installed
- All Pipe Connections Points Do Not Leak
- Water Drains From Drain Hose Properly
- All Piping is Properly Insulated
- Indoor Unit Responds to Remote Controller
- Indoor Unit Louvers Work Properly
- System Works in Both HEAT + COOL mode

AFTER TEST RUN COMPLETION

After the 10 boxes above have been checked as having PASSED, perform the following operation:

1. Using the remote control, return the system to a normal desired operating temperature.
2. Using insulation tape, wrap the indoor unit refrigerant pipe connections that were left uncovered during the indoor unit installation process.

IF AMBIENT TEMPERATURES ARE TOO HIGH TO RUN A HEATING TEST:

If outside temperatures are too high to permit HEATING mode on the remote, do the following:

1. Turn the unit on and put it in heat mode using the emergency button as depicted on **Page 8**.
2. Run the heating mode test as normal, and turn the unit back off using the button when complete.

DOUBLE CHECK ALL PIPE CONNECTIONS

During operation, the pressure of the refrigerant circuit will increase. This may reveal leaks that were not present during your initial leak check. Take time during the Test Run to double-check that all copper pipe connection points are leak-free. Refer to the Leak Check page for instructions. Cooling mode pressures should be 120-155 PSI. Heating mode pressures should be 320-450 PSI.

Troubleshooting

T

MALFUNCTION	POSSIBLE CAUSES
If the appliance does not operate or respond...	There is a power failure/plug pulled out or tripped/wrong breaker (wrong wiring)
	The indoor/outdoor unit fan motor was damaged
	There is a faulty compressor or thermomagnetic circuit breaker
	There is a faulty protective device or fuses
	The electrical connections are loose
	The system has entered a protection mode
	The system has entered an overvoltage or undervoltage protection
	The TIMER-ON function is active
	The electronic control board was damaged
If there are strange odors...	The air filter is dirty
If there's running water...	There was a backflow of condensate water into the system's drain pan.
If a fine mist is coming from the air outlet...	This occurs when the air in the room becomes very cold, for example in "COOLING" or "DEHUMIDIFICATION/DRY" modes
If strange noises are being emitted...	This noise is made by the expansion or contraction of the front panel due to variations in temperature, and if so, is normal
If the airflow is insufficient, and the air is not hot or cold enough...	The temperature setting is unsuitable
	The air conditioner intakes and outlets may be obstructed
	The air filter may be dirty
	The fan speed may be set at the minimum
	There may be too many other heat sources in the room
	The system may be getting low on refrigerant, pressures should be checked
If the appliance does not respond to commands...	The remote control may not be close enough to the indoor unit
	The batteries of remote control may need to be replaced
	There are obstacles between remote control and indoor unit signal receiver
If the display is off...	The DISPLAY button has been pressed
	There has been a power failure
Switch off the air conditioner immediately and cut off the power supply in the event of...	Strange noises not due to expansion/contraction are heard during operation
	The electronic control board is faulty or malfunctioning
	Any fuses or switches are faulty or malfunctioning
	The sound of spraying water or objects are heard inside the appliance
	The cables or plugs have overheated
	There are very strong odors being emitted from the appliance

ERROR SIGNALS ON THE DISPLAY

In case of error, the display on the indoor unit may show the following error codes:

Display	Description of the error	Display	Description of the trouble
E1	Indoor temperature sensor fault	E8	Outdoor discharge temperature sensor fault
E2	Indoor pipe temperature sensor fault	E9	Outdoor IPM module fault
E3	Outdoor pipe temperature sensor fault	EA	Outdoor current detection fault
E4	Refrigerant system leakage or fault	EO	Indoor ↔ Outdoor Unit Communication Fault
E6	Malfunction of indoor fan motor	FY	Refrigerant Leak / Low Pressure Detected
E7	Outdoor air temperature sensor fault	EH	Outdoor suction temperature sensor fault

Do not attempt to use system until error code is diagnosed and resolved. Forcing the system to run can cause irreversible damage.

Solutions to Common Issues and Scenarios

Issue: The Indoor Air Handler Does Not Turn On.

- Solution: Try the manual emergency button on the indoor unit, to rule out problems with the remote.*
- Solution: Verify that the wire order is equal between indoor and outdoor units^[1]. Color order must match. Check for splices or damage on the control cable. To rule out variables, remove any accessory items such as UV lights or condensate pumps until the problem is resolved.
- Solution For **230V** systems: Use a multi-meter to check AC voltage across terminals L1-L2 on the **outdoor system**^[2](touch one probe to L1, the other probe goes on L2, do not measure each leg to ground). Verify whether the reading is between 208~253 VAC.
 - **If the reading is between 208 and 253 VAC**, measure whether the reading is the same across 2-3 on both the **outdoor unit**, and the **indoor unit**. All readings must match. The system must receive a **full 230V** reading in order to function.
 - **If the reading is 0 VAC**, then the system is not receiving proper power from the power source. Some common reasons are:
 - A fused disconnect is being used, but fuses are blown or not inserted properly.
 - The disconnect box bus-bar is in the OFF position.
 - A double-pole breaker is not being used. Single or tandem breakers will not work.

*See Page 8

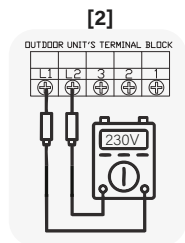
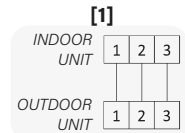

Issue: The pressure reading does not rise when releasing refrigerant during leak check.

- Solution: Verify that the gauge tube pin on the manifold gauge is fully engaging the outdoor unit service port's Schrader valve. A pin that is over or underexposed will not allow the gauge to access the refrigerant circuit, preventing pressure measurement and/or proper vacuuming. The depressor pin inside the hose connector is adjustable for proper Schrader valve engagement.
 - A telltale sign that this is happening is whether the gauge reading goes to instant vacuum when the pump is first turned on. This means only the gauge is being vacuumed.
 - If so, vacuuming will need to be re-performed, since only the gauge itself was vacuumed.

Issue: The system is not holding a vacuum.

- Solution: A leak in the gauge hoses is likely. Repair the leak and/or check the vacuum pump.
- Solution: Check the connection points for proper contact and torque and tighten if necessary.

Issue: The indoor air handler is leaking water

- Solution: Verify that the indoor unit is both horizontally and vertically level.
- Solution: Check that the drain tube is at a continuous downward pitch.
 - Pour a cup of water over the indoor unit's coils so that it reaches the drain pan.
 - Verify that the water drains out of the tube freely. If it doesn't, find the cause and correct it.

Issue: The system indicates that a refrigerant leak is present.

- Solution: Cut off power to the system. Prepare a soapy water spray, and spray the connection points of the line set. The point where bubbles form is where the leak is located. Tighten the connection and re-test the system. Have the system re-charged only after the leak is repaired.

Issue: The fan runs in cooling mode but in heating mode there is weak or no airflow.

- Solution: Fan speed control is typically not available to the user in heating mode. If the coil is unable to heat up then the fan will not run at speed. This may indicate low refrigerant as well.

Anchoring the Outdoor Unit

The outdoor unit can be anchored to the ground or to wall-mounted brackets. The following is a list of different outdoor unit sizes and the distance between their mounting feet. Prepare the installation base of the unit according to the dimensions found below:

Model	D	E	F	G	H	I	J	K
YN012ALUI17RPD (12000 BTU - 115V)	712 mm	498 mm	234 mm	415 mm	291 mm	225 mm	48.5 mm	52 mm
	28"	19-5/8"	9-1/4"	16-3/8"	11-1/2"	8-7/8"	1-7/8"	2"
YN012GLUI17RPD (12000 BTU - 230V)	712 mm	498 mm	234 mm	415 mm	291 mm	225 mm	48.5 mm	52 mm
	28"	19-5/8"	9-1/4"	16-3/8"	11-1/2"	8-7/8"	1-7/8"	2"
YN018GLUI17RPD (18000 BTU - 230V)	726 mm	549 mm	252 mm	433.8 mm	305 mm	278 mm	48 mm	52 mm
	28-5/8"	21-5/8"	9-7/8"	17-1/8"	12"	11"	1-7/8"	2"
YN024GLUI17RPD (24000 BTU - 230V)	780 mm	602 mm	288 mm	516 mm	349 mm	314 mm	54 mm	57 mm
	30-3/4"	23-3/4"	11-3/8"	20-1/4"	13-3/4"	12-3/8"	2-1/8"	2-1/4"
YN036GLUI17RPD (36000 BTU - 230V)	910 mm	803 mm	359 mm	607 mm	421 mm	390 mm	60 mm	63 mm
	35-7/8"	31-5/8"	14-1/8"	23-7/8"	16-5/8"	15-3/8"	2-3/8"	2-1/2"

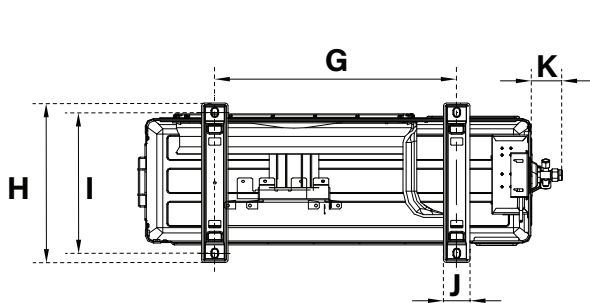

Underside View

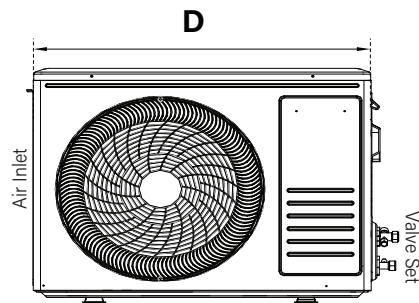

Front View

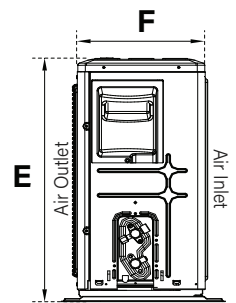

Side View

(When mounting on slab, installation of drain joint and tubing shown on page 40 is not necessary.)

If installing the unit on the ground or on a concrete mounting platform, do the following:

1. Mark the positions for four expansion bolts based on dimensions in the "Unit Mounting Dimensions" chart.
2. Pre-drill holes for expansion bolts.
3. Clean concrete dust away from holes.
4. Place a nut on the end of each expansion bolt.

5. Hammer expansion bolts into each hole.
6. Remove the nuts from expansion bolts, and place the outdoor unit onto the bolts.
7. Put washers onto each expansion bolt, then replace each of the nuts.
8. Using a wrench, tighten each nut until snug.

**WHEN DRILLING INTO CONCRETE,
WEAR EYE PROTECTION AT ALL TIMES!**

Guidelines for Drilling the Wall Hole

Below are the suggested locations for the wall hole for systems between 12,000 - 36,000 BTU. Both left side/right side exits are considered with 2-1/2" hole. Confirm holes are proper by corner tracing.

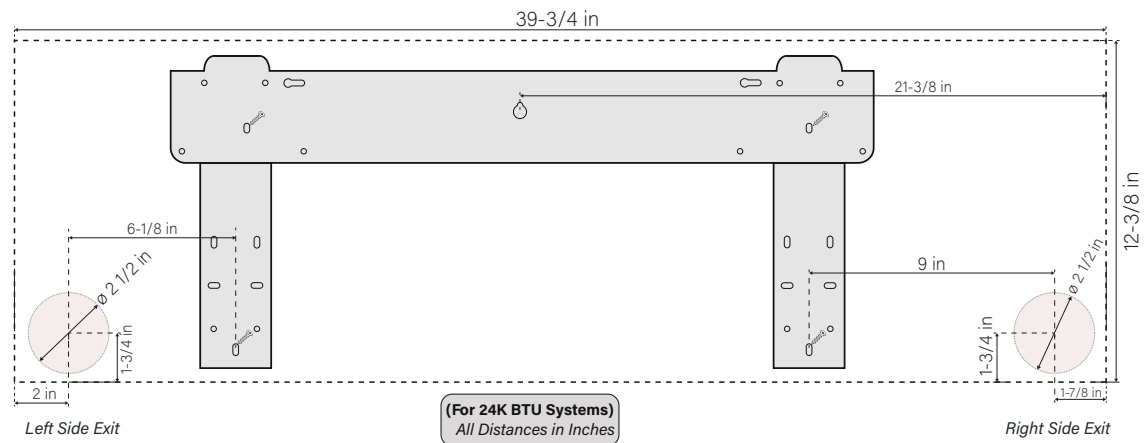
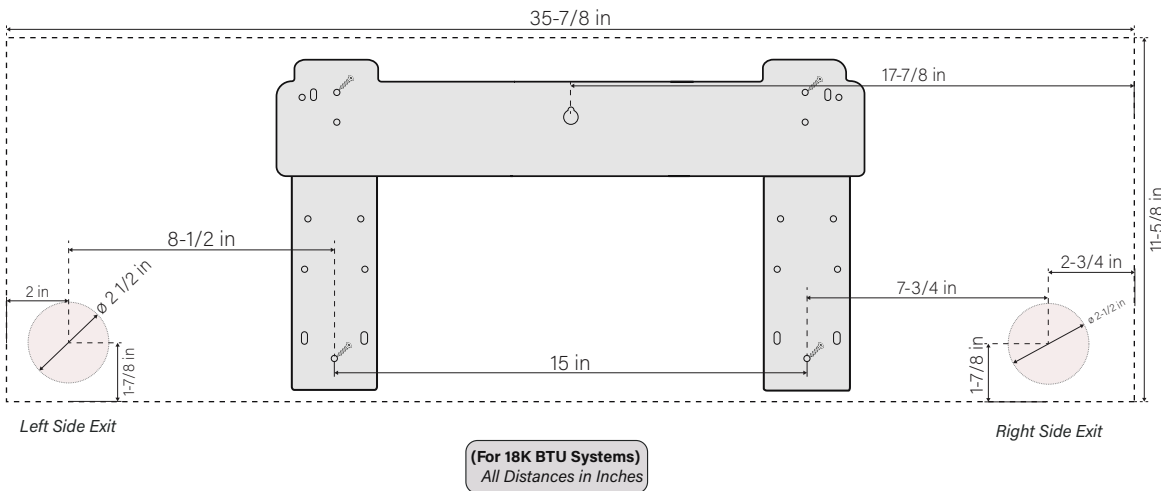
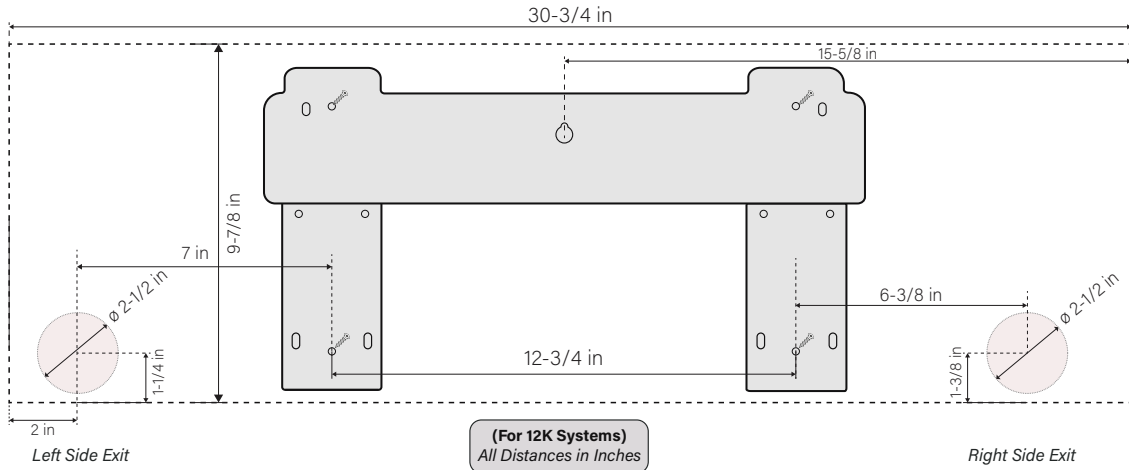

Guidelines for Drilling the Wall Hole (continued)

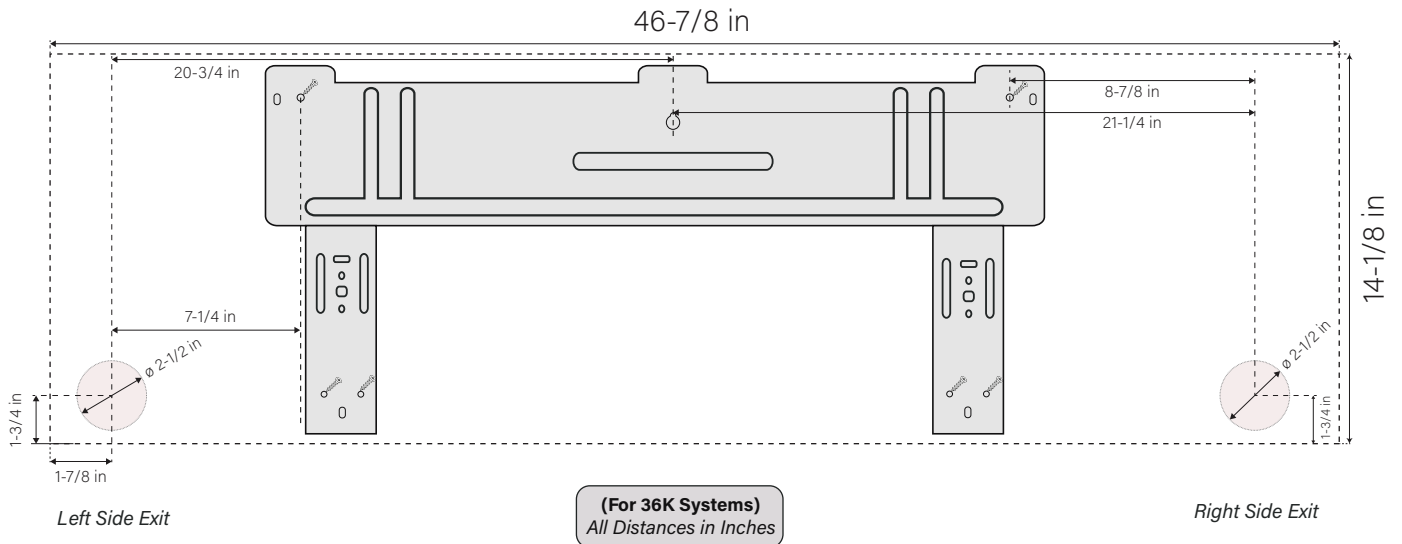

Simplified Wiring Diagram (115V and 230V)

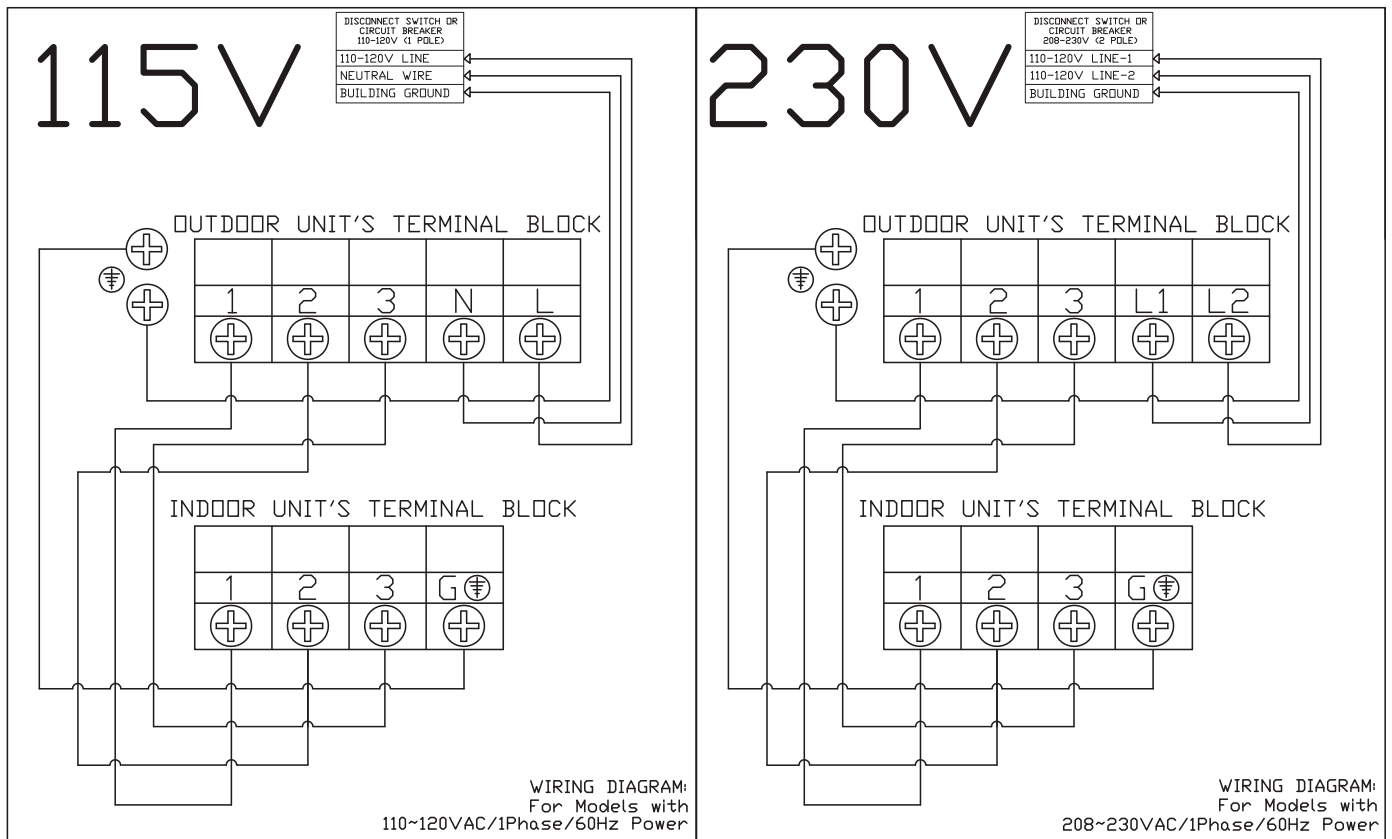

Indoor Air Handler Control Board Wiring Diagrams

INDOOR UNIT: WT012ALUI17HLD, WT012GLUI17HLD, WT018GLUI17HLD, WT024GLUI17HLD

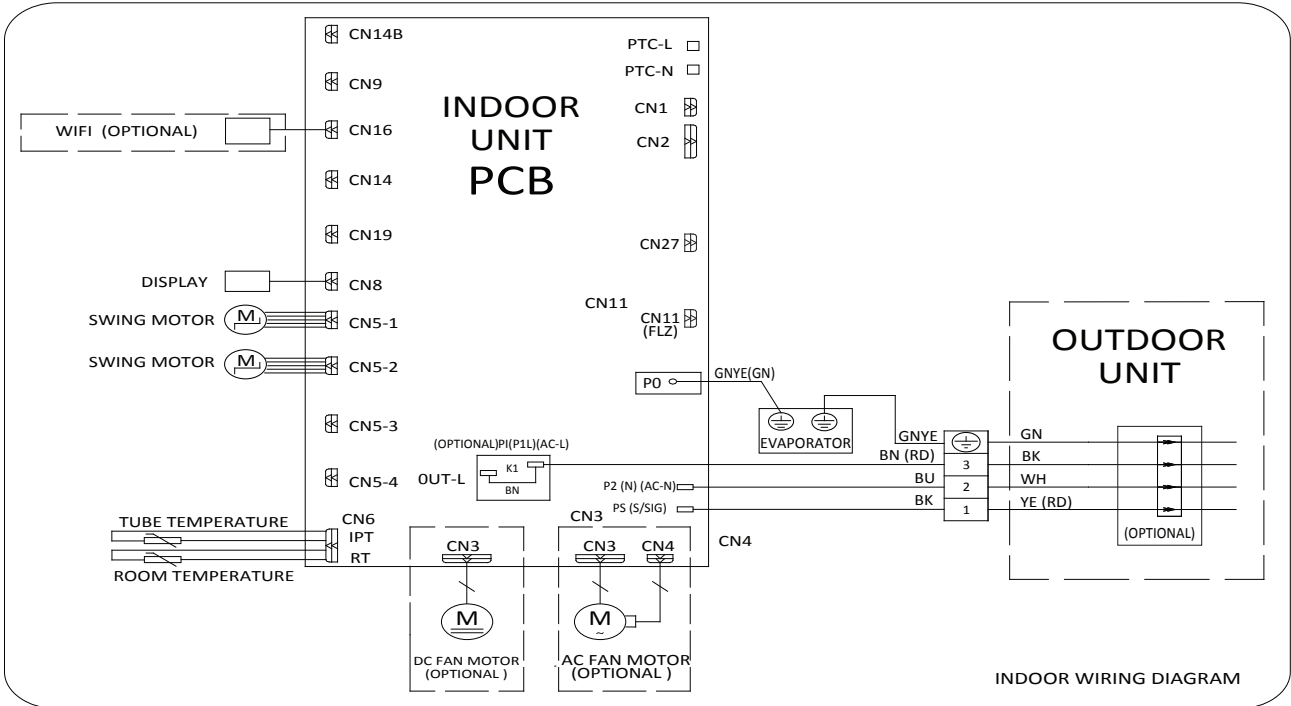

INDOOR UNIT: WT036GLUI17HLD

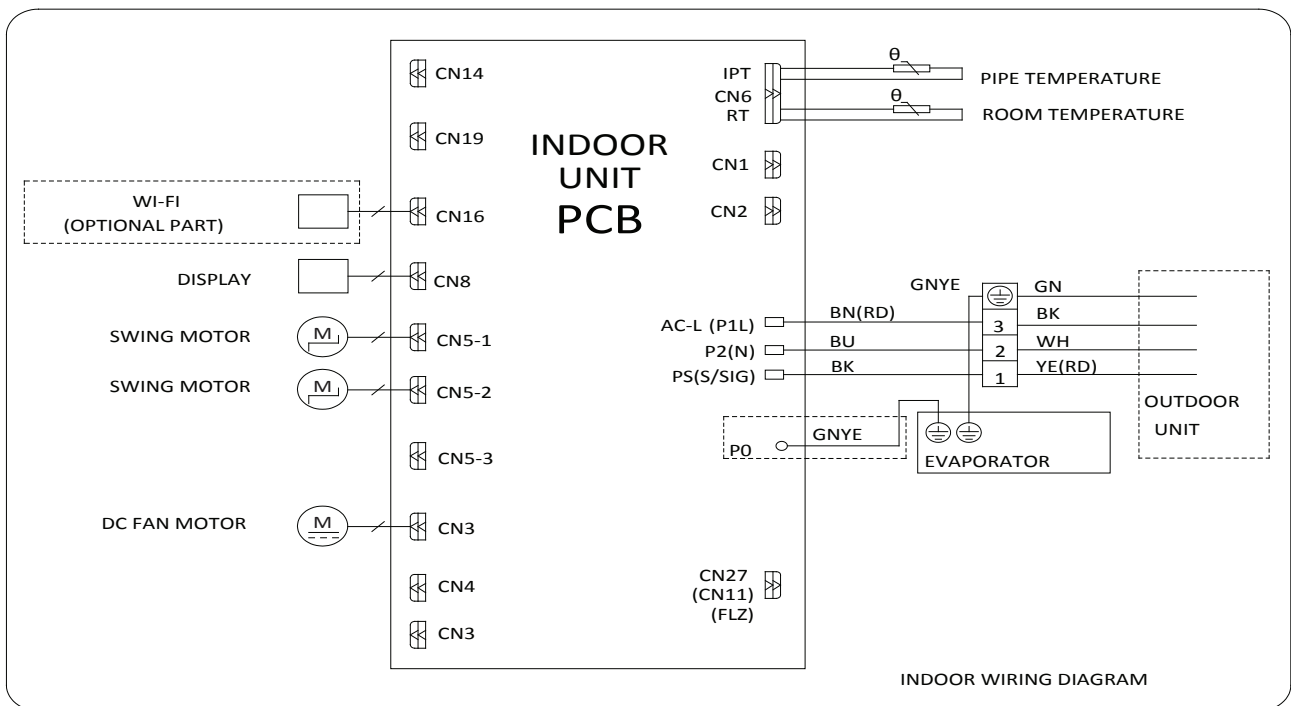

Outdoor Condensing Unit Control Board Wiring Diagrams

OUTDOOR UNIT: YN012ALUI17RPD

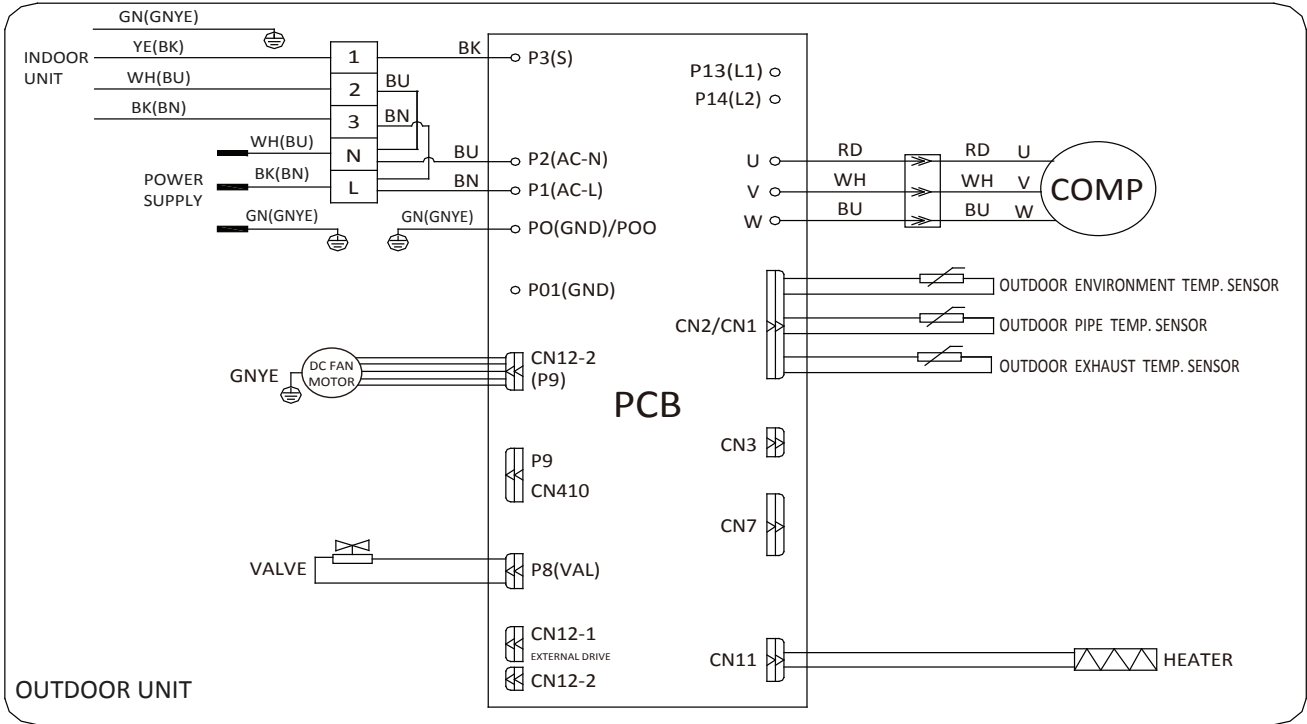

OUTDOOR UNIT: YN012GLUI17RPD, YN018GLUI17RPD, YN024GLUI17RPD, YN036GLUI17RPD

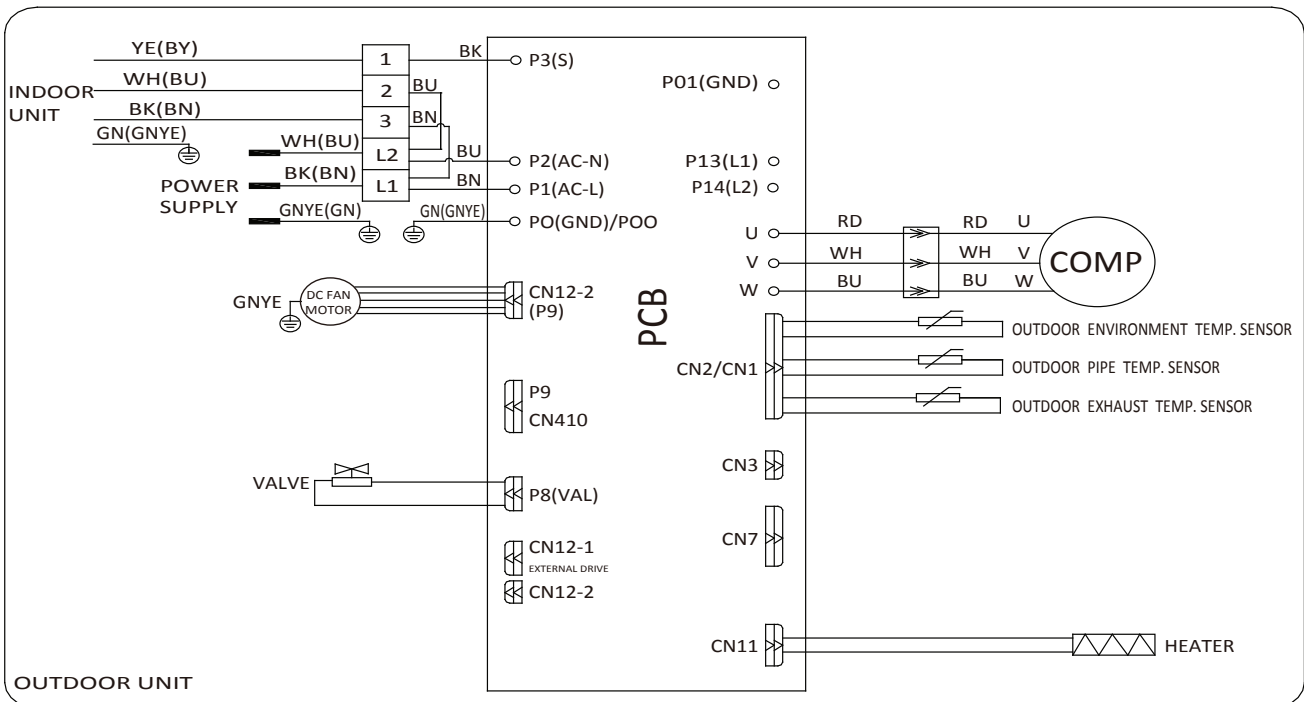

Product Disposal Guidelines

This appliance contains refrigerant and other potentially hazardous materials. When disposing of this appliance, the law requires special collection and treatment. Do not dispose of this product as household waste or unsorted municipal waste.

All refrigerant and oil must be removed prior to disposal as outlined within this manual.

When disposing of this appliance, you have the following options:

- Dispose of the appliance at a designated municipal electronic waste collection facility.
- When buying a new appliance, the retailer takes back the old appliance free of charge.
- The manufacturer takes back the old appliance free of charge.
- Sell the appliance to certified scrap metal dealers.

Special Notice

Disposing of this appliance improperly, or in other natural surroundings, endangers your health and is bad for the environment. Hazardous substances may leak into the ground water and enter the food chain. Please follow proper disposal protocol.

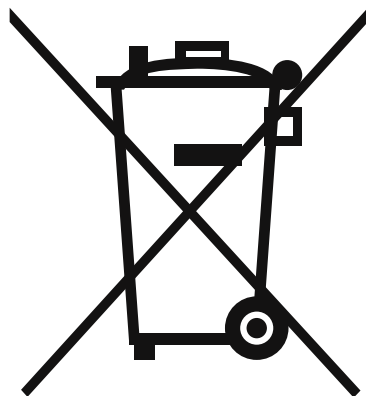

If Refrigerant Has Been Added to the System During Install

(For the Installer) Please fill in the following:

- 1) The factory refrigerant charge of the product (located on the outdoor unit nameplate).
- 2) The additional refrigerant charged into product.
- 1+2) The total refrigerant charge.

① = kg (ozs)

② = kg (ozs)

① + ② = kg (ozs)

Instruct the user to retain this information for reference during future service and maintenance.

System Notes



The design and specifications of this product are subject to change without prior notice as development continues. Consult with the sales agency or manufacturer for details. Refer to the equipment nameplate for all other applicable specifications.



is a registered trademark of Parker Davis HVAC International, LLC.

Parker Davis HVAC International
7290 NW 77 Court, Miami, FL 33166 - USA
Tel : (305) 513-4488
Fax : (305) 513-4499
E-mail : info@pdhvac.com
Website: www.pdhvac.com

Pioneer product line, parts, and supplies are available online for convenient ordering at:
www.highseer.com
www.pioneerminisplit.com

Scan the below code to visit our support page where you can find more installation materials:



Copyright 2025, Parker Davis HVAC International, LLC., All rights reserved.
