



REFRIGERATOR USER INSTRUCTIONS

THANK YOU for purchasing this high-quality product. Register your new refrigerator at www.maytag.com. In Canada, register your refrigerator at www.maytag.ca.

For future reference, please make a note of your product model and serial numbers. These can be located on the inside wall of the refrigerator compartment.

Model Number _____

Serial Number _____

TABLE OF CONTENTS/ TABLE DES MATIÈRES

REFRIGERATOR SAFETY	2	SÉCURITÉ DU RÉFRIGÉRATEUR	24
Proper Disposal of Your Old Refrigerator	3	Mise au rebut du vieux réfrigérateur	26
INSTALLATION INSTRUCTIONS	3	INSTRUCTIONS D'INSTALLATION	26
Unpack the Refrigerator.....	3	Déballage du réfrigérateur.....	26
Location Requirements	4	Exigences d'emplacement.....	27
Electrical Requirements	4	Spécifications électriques.....	27
Water Supply Requirements	4	Spécifications de l'alimentation en eau	27
Connect the Water Supply.....	5	Raccordement à la canalisation d'eau	28
Refrigerator Door(s) and Drawer	6	Porte et tiroir du réfrigérateur.....	29
Door Closing and Door Alignment	12	Fermeture et alignement de la porte.....	36
REFRIGERATOR USE	12	UTILISATION DU RÉFRIGÉRATEUR	36
Opening and Closing Doors (French door models)	12	Ouverture et fermeture des portes (modèles avec porte à double battant).....	36
Using the Controls	13	Utilisation des commandes	37
Electronic Controls.....	13	Commandes électroniques.....	37
Digital Controls.....	13	Commandes numériques.....	37
Crisper Humidity Control	15	Réglage de l'humidité dans le bac à légumes.....	39
Ice Maker.....	15	Machine à glaçons	39
Water Dispenser.....	15	Distributeur d'eau.....	39
Water Filtration System.....	16	Système de filtration d'eau	40
REFRIGERATOR CARE	16	ENTRETIEN DU RÉFRIGÉRATEUR	40
Cleaning	16	Nettoyage	40
Changing the Light Bulb	17	Remplacer l'ampoule d'éclairage	41
Vacation and Moving Care.....	17	Précautions à prendre pour les vacances ou le déménagement.....	42
TROUBLESHOOTING	18	DÉPANNAGE	43
Refrigerator Operation	18	Fonctionnement du réfrigérateur	43
Temperature and Moisture	19	Température et humidité	44
Ice and Water	19	Glaçons et eau	44
Accessories	20	Accessoires	46
WATER FILTER CERTIFICATIONS	20	FEUILLES DE DONNÉES SUR LA PERFORMANCE	47
PERFORMANCE DATA SHEETS	21	GARANTIE	49
WARRANTY	23		

REFRIGERATOR SAFETY

Your safety and the safety of others are very important.

We have provided many important safety messages in this manual and on your appliance. Always read and obey all safety messages.



This is the safety alert symbol.

This symbol alerts you to potential hazards that can kill or hurt you and others.

All safety messages will follow the safety alert symbol and either the word "DANGER" or "WARNING."

These words mean:

⚠ DANGER

You can be killed or seriously injured if you don't immediately follow instructions.

⚠ WARNING

You can be killed or seriously injured if you don't follow instructions.

All safety messages will tell you what the potential hazard is, tell you how to reduce the chance of injury, and tell you what can happen if the instructions are not followed.

IMPORTANT SAFETY INSTRUCTIONS

WARNING: To reduce the risk of fire, electric shock, or injury when using your refrigerator, follow these basic precautions:

- Plug into a grounded (earthed) outlet.
- Do not remove ground prong.
- Do not use an adapter.
- Do not use an extension cord.
- Disconnect power before servicing.
- Replace all parts and panels before operating.
- Remove doors from your old refrigerator.
- Use nonflammable cleaner.
- Do not store or use petrol, flammable liquids or gas in the vicinity of this or other electrical appliances. The fumes can cause fires or explosions.
- Do not store explosive substances such as aerosol cans with a flammable propellant in this refrigerator.
- Do not use or place electrical devices inside the refrigerator compartments if they are not of the type expressly authorized by the manufacture.
- Use two or more people to move and install refrigerator.
- Disconnect power before installing ice maker (on ice maker kit ready models only).
- A qualified service technician must install the water line and ice maker. See installation instruction supplied with ice maker kit IC13B for complete details.
- Connect to a potable water supply only.
- Use a sturdy glass when dispensing ice (on some models).
- This appliance is not intended for use by persons (including children) with reduced physical, sensory or mental capabilities, or lack of experience and knowledge, unless they have been given supervision or instruction concerning use of the appliance by a person responsible for their safety.
- Children should be supervised to ensure that they do not play with the appliance.
- To avoid the risk of children becoming trapped and suffocating, do not allow them to play or hide inside the refrigerator.
- If the power supply cord is damaged, it must be replaced by the manufacturer or its service agent or a similarly qualified person.

SAVE THESE INSTRUCTIONS

State of California Proposition 65 Warnings:

WARNING: This product contains one or more chemicals known to the State of California to cause cancer.

WARNING: This product contains one or more chemicals known to the State of California to cause birth defects or other reproductive harm.

Proper Disposal of Your Old Refrigerator

⚠ WARNING

Suffocation Hazard

Remove doors from your old refrigerator.

Failure to do so can result in death or brain damage.

IMPORTANT: Child entrapment and suffocation are not problems of the past. Junked or abandoned refrigerators are still dangerous—even if they will sit for “just a few days.” If you are getting rid of your old refrigerator, please follow these instructions to help prevent accidents.

Before You Throw Away Your Old Refrigerator or Freezer:

- Take off the doors.
- Leave the shelves in place so that children may not easily climb inside.

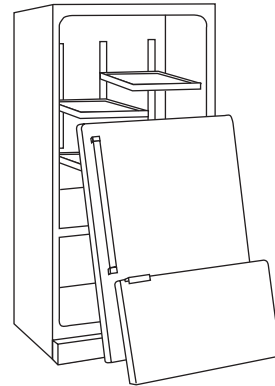

Important information to know about disposal of refrigerants:

Dispose of refrigerator in accordance with Federal and Local regulations. Refrigerants must be evacuated by a licensed, EPA certified refrigerant technician in accordance with established procedures.

INSTALLATION INSTRUCTIONS

Unpack the Refrigerator

⚠ WARNING

Excessive Weight Hazard

Use two or more people to move and install refrigerator.

Failure to do so can result in back or other injury.

Remove the Packaging

- Remove tape and glue residue from surfaces before turning on the refrigerator. Rub a small amount of liquid dish soap over the adhesive with your fingers. Wipe with warm water and dry.
- Do not use sharp instruments, rubbing alcohol, flammable fluids, or abrasive cleaners to remove tape or glue. These products can damage the surface of your refrigerator. For more information, see “Refrigerator Safety.”
- Dispose of/recycle all packaging materials.

When Moving Your Refrigerator:

Your refrigerator is heavy. When moving the refrigerator for cleaning or service, be sure to cover the floor with cardboard or hardboard to avoid floor damage. Always pull the refrigerator straight out when moving it. Do not wiggle or “walk” the refrigerator when trying to move it, as floor damage could occur.

Clean Before Using

After you remove all of the packaging materials, clean the inside of your refrigerator before using it. See the cleaning instructions in “Refrigerator Care.”

Important information to know about glass shelves and covers:

Do not clean glass shelves or covers with warm water when they are cold. Shelves and covers may break if exposed to sudden temperature changes or impact, such as bumping. Tempered glass is designed to shatter into many small, pebble-size pieces. This is normal. Glass shelves and covers are heavy. Use both hands when removing them to avoid dropping.

Location Requirements

⚠ WARNING



Explosion Hazard

Keep flammable materials and vapors, such as gasoline, away from refrigerator.

Failure to do so can result in death, explosion, or fire.

IMPORTANT: This refrigerator is designed for indoor, household use only.

This appliances is intended to used in household and similar applications such as:

- Staff kitchen areas in shops, office and other working environments,
- Farm houses and by clients in hotels, motels and other residential type environments,
- Bread and breakfast type environments,
- Catering and similar non-retail applications.

To ensure proper ventilation for your refrigerator, allow for ½" (1.25 cm) of space on each side and at the top. Allow for 1" (2.54 cm) of space behind the refrigerator. If your refrigerator has an ice maker, allow extra space at the back for the water line connections. When installing your refrigerator next to a fixed wall, leave 2½" (6.3 cm) minimum on the hinge side (some models require more) to allow for the door to swing open.

NOTE: This refrigerator is intended for use in a location where the temperature ranges from a minimum of 55°F (13°C) to a maximum of 110°F (43°C). The preferred room temperature range for optimum performance, which reduces electricity usage and provides superior cooling, is between 60°F (15°C) and 90°F (32°C). It is recommended that you do not install the refrigerator near a heat source, such as an oven or radiator.

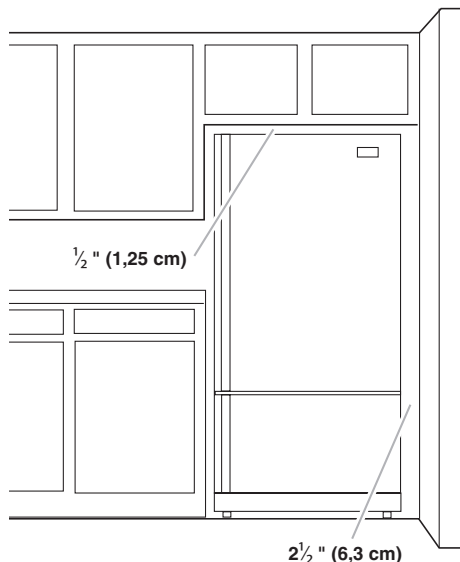

Electrical Requirements

Before you move your refrigerator into its final location, it is important to make sure you have the proper electrical connection.

If the supply cord is damaged, it must be replaced by the manufacturer or its service agent or a similarly qualified person. Do not use a cord that shows cracks or abrasion damage along its length or at either the plug or connector end.

⚠ WARNING



Electrical Shock Hazard

Plug into a grounded 3 prong outlet.

Do not remove ground prong.

Do not use an adapter.

Do not use an extension cord.

Failure to follow these instructions can result in death, fire, or electrical shock.

Recommended Grounding Method

A 115 volt, 60 Hz, AC only 15 or 20 A fused, grounded electrical supply is required. It is recommended that a separate circuit serving only your refrigerator and approved accessories be provided. Use an outlet that cannot be turned off by a switch. Do not use an extension cord.

NOTE: Before performing any type of installation, cleaning, or removing a light bulb, turn Cooling OFF, and then disconnect the refrigerator from the electrical source. When you have finished, reconnect the refrigerator to the electrical source and turn Cooling ON. See "Using the Control(s)."

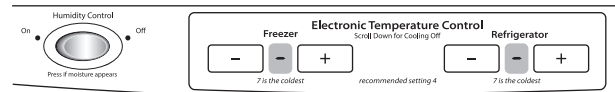

Water Supply Requirements

Gather the required tools and parts before starting installation. Read and follow the instructions provided with any tools listed here.

TOOLS NEEDED:

- 7/16" and 1/2" Open-end or two adjustable wrenches
- 1/4" Drill bit
- Cordless drill

IMPORTANT:

- Connect to potable water supply only.

Do not use with water that is microbiologically unsafe or of unknown quality without adequate disinfection before or after the system. Systems certified for cyst reduction may be used on disinfected waters that may contain filterable cysts.

- All installations must meet local plumbing code requirements.
- Do not use a piercing-type or 3/16" (4.76 mm) saddle valve which reduces water flow and clogs more easily.
- Use copper tubing and check for leaks. Install copper tubing only in areas where the household temperatures will remain above freezing.
- For models with water filters, the disposable water filter should be replaced at least every 6 months.

Water Pressure

A cold water supply with water pressure of between 35 and 120 psi (241 and 827 kPa) is required to operate the water dispenser and ice maker. If you have questions about your water pressure, call a licensed, qualified plumber.

Reverse Osmosis Water Supply

IMPORTANT: The pressure of the water supply coming out of a reverse osmosis system going to the water inlet valve of the refrigerator needs to be between 35 and 120 psi (241 and 827 kPa).

If a reverse osmosis water filtration system is connected to your cold water supply, the water pressure to the reverse osmosis system needs to be a minimum of 40 to 60 psi (276 to 414 kPa).

If the water pressure to the reverse osmosis system is less than 40 to 60 psi (276 to 414 kPa):

- Check to see whether the sediment filter in the reverse osmosis system is blocked. Replace the filter if necessary.
- Allow the storage tank on the reverse osmosis system to refill after heavy usage.
- If your refrigerator has a water filter, it may further reduce the water pressure when used in conjunction with a reverse osmosis system. Remove the water filter. See "Water Filtration System."

If you have questions about your water pressure, call a licensed, qualified plumber

Connect the Water Supply

Read all directions before you begin.

IMPORTANT:

- Plumbing shall be installed in accordance with the International Plumbing Code and any local codes and ordinances.
- The gray water tubing on the back of the refrigerator (which is used to connect to the household water line) is a PEX(cross-linked polyethylene) tube. Copper and PEX tubing connections from the household water line to the refrigerator are acceptable, and will help avoid off-taste or odor in your ice or water. Check for leaks.

If PEX tubing is used instead of copper, we recommend the following Whirlpool Part Numbers:

W10505928RP (7 ft [2.14 m] jacketed PEX),
8212547RP (5 ft [1.52 m] PEX), or
W10267701RP (25 ft [7.62 m] PEX).

- Install tubing only in areas where temperatures will remain above freezing.
- If you turn on the refrigerator before the water line is connected, turn off the ice maker to avoid excessive noise or damage to the water valve.

Connect to Water Line

1. Unplug refrigerator or disconnect power.
2. Turn OFF main water supply. Turn ON nearest faucet long enough to clear line of water.
3. Find a 1/2" to 1 1/4" (12.7 mm to 31.8 mm) vertical cold water pipe near the refrigerator.
IMPORTANT:
 - Make sure it is a cold water pipe.
 - Horizontal pipe will work, but the following procedure must be followed: Drill on the top side of the pipe, not the bottom. This will help keep water away from the drill. This also keeps normal sediment from collecting in the valve.
4. Determine the length of copper tubing you need. Measure from the connection on the rear of the refrigerator to the water pipe. Add 7 ft (2.1 m) to allow for cleaning. Use 1/4" (6.35 mm) O.D. (outside diameter) copper tubing. Be sure both ends of copper tubing are cut square.
5. Using a cordless drill, drill a 1/4" hole in the cold water pipe you have selected.

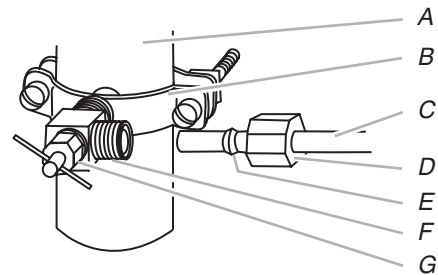

A. Cold water pipe
B. Pipe clamp
C. Copper tubing
D. Compression nut
E. Compression sleeve
F. Shutoff valve
G. Packing nut

6. Fasten the shutoff valve to the cold water pipe with the pipe clamp. Be sure the outlet end is solidly in the 1/4" drilled hole in the water pipe and that the washer is under the pipe clamp. Tighten the packing nut. Tighten the pipe clamp screws slowly and evenly so the washer makes a watertight seal. Do not overtighten.
7. Slip the compression sleeve and compression nut on the copper tubing as shown. Insert the end of the tubing into the outlet end squarely as far as it will go. Screw compression nut onto outlet end with adjustable wrench. Do not overtighten or you may crush the copper tubing.
8. Place the free end of the tubing in a container or sink, and turn ON the main water supply. Flush the tubing until water is clear. Turn OFF the shutoff valve on the water pipe.

Connect to Refrigerator

Depending on your model, the water line may come down from the top or up from the bottom. Follow the connection instructions for your model.

Style 1

1. Remove plastic cap from water valve inlet port. Attach the copper tube to the valve inlet using a compression nut and sleeve as shown. Tighten the compression nut. Do not overtighten. Confirm copper tubing is secure by pulling on copper tubing.
2. Create a service loop with the copper tubing. Avoid kinks when coiling the copper tubing. Secure copper tubing to refrigerator cabinet with a "P" clamp.

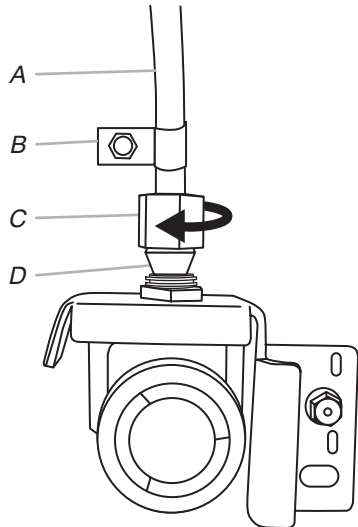

A. Copper tubing
B. "P" clamp
C. Compression nut
D. Compression sleeve

3. Turn on water supply to refrigerator and check for leaks. Correct any leaks.

Style 2

1. Create a service loop (minimum diameter of 2 ft [61 cm]) with the copper tubing. Avoid kinks when coiling the copper tubing.
2. Remove the plastic cap from water valve inlet port. Place a compression nut and sleeve on the copper tubing.
3. Insert the end of the copper tubing into the water valve inlet port. Shape tubing slightly so that the tubing feeds straight into the port to avoid kinks.
4. Slide the compression nut over the sleeve and screw into the water valve inlet port.

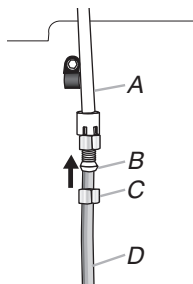

A. Plastic water tubing
B. Sleeve
C. Compression nut
D. Copper tubing

5. Using an adjustable wrench, hold the nut on the plastic water line to keep it from moving. Then, with a second wrench turn the compression nut on the copper tubing counterclockwise to completely tighten. Do not overtighten.

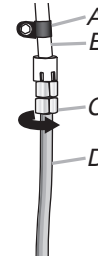

A. "P" clamp
B. Plastic water line
C. Compression nut
D. Copper tubing

6. Check connection by pulling on copper tubing. Attach the plastic water line to the refrigerator cabinet with a "P" clamp.
7. Turn on water supply to the refrigerator and check for leaks. Correct any leaks.

Complete the Installation

⚠ WARNING



Electrical Shock Hazard

Plug into a grounded 3 prong outlet.

Do not remove ground prong.

Do not use an adapter.

Do not use an extension cord.

Failure to follow these instructions can result in death, fire, or electrical shock.

1. Plug into a grounded 3 prong outlet.

NOTE: Allow 24 hours to produce the first batch of ice. Discard the first three batches of ice produced. Allow 3 days to completely fill the ice contain

Refrigerator Door(s) and Drawer

TOOLS NEEDED: 5/16", 3/8", 1/4" hex head socket wrenches, a #2 Phillips screwdriver, and a flat-blade screwdriver.

IMPORTANT:

- Your refrigerator has a standard reversible refrigerator door with either a freezer door or freezer drawer, or French doors. Follow the instructions specific to the door style of your model.
- All graphics referenced in the following instructions are included later in this section after "Final Steps." The graphics shown for the standard door are for a right-hand swing refrigerator (hinges factory installed on the right).
- If you only want to remove and replace the doors see "Remove Doors and Hinges" and "Replace Doors and Hinges."
- Before you begin, turn the refrigerator control OFF, and remove food and adjustable door or utility bins from the doors.

Remove and Replace Handles

Refrigerator Door(s)

- To remove handles, use a 3/32" hex key to loosen the two setscrews located on the side of each handle. Pull the handle straight out from the door or drawer. Make sure you keep the screws for reattaching the handles. See Handle graphics 1 or 2.
- To replace handles, reverse the directions.

Freezer Drawer

- To remove handles, use a 3/32" hex key to loosen the two setscrews located under each handle. Pull the handle straight out from the door or drawer. Make sure you keep the screws for reattaching the handles. See Graphic 4.
- To replace handles, reverse the directions.

Freezer Door

- To remove handle, use a flat-blade screwdriver to remove the two screws fastening the handle to the freezer door. See Graphic 4.
- To replace handle, reverse the directions.

Remove Doors and Hinges

Standard Door

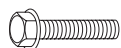

Freezer drawer models

1. Unplug refrigerator or disconnect power.
2. Keep the refrigerator door closed until you are ready to lift it free from the cabinet.

NOTE: Provide additional support for the door while the hinges are being moved. Do not depend on the door gasket magnets to hold the door in place while you are working.

3. Remove the parts for the top hinge as shown in Top Hinge graphic. Lift the refrigerator door free from the cabinet.
4. Remove the parts for the bottom hinge as shown in Bottom Hinge graphic.

Freezer door models

1. Unplug refrigerator or disconnect power.
2. Keep the freezer door closed until you are ready to lift it free from the cabinet.

NOTE: Provide additional support for the door while the hinges are being moved. Do not depend on the door gasket magnets to hold the door in place while you are working.
3. Remove the parts for the top hinge as shown in Top Hinge graphic. Lift the refrigerator door free from the cabinet.
4. Remove the center hinge pin and remove the hinge screws as shown in the Center Hinge graphic. Lift the freezer door free from the cabinet.
5. Remove the base grille by grasping the grille firmly with both hands and pulling it toward you.
6. Remove the parts for the bottom hinge as shown in Bottom Hinge graphic.

French Doors

WARNING



Electrical Shock Hazard

Disconnect power before removing doors.

Failure to do so can result in death or electrical shock.

1. Unplug refrigerator or disconnect power.
2. Keep the refrigerator doors closed until you are ready to lift them free from the cabinet.

NOTE: Provide additional support for the refrigerator door while the hinges are being removed. Do not depend on the door gasket magnets to hold the door in place while you are working.
3. Starting with the right-hand side door, remove the parts for the top hinge as shown in Top Hinge graphic. Lift the refrigerator door from the bottom hinge pin.
4. Remove the hinge pin cover from the bottom hinge pin and keep it for later use. See Bottom Hinge graphic.
5. Before removing the left-hand side door, disconnect the wiring plug located on top of the top hinge by wedging a flat-blade screwdriver or your fingernail between the two sections. See Wiring Plug graphic.

NOTE: The green, ground wire remains attached to the hinge.
6. Remove the parts for the left-hand side door top hinge as shown in the Top Hinge graphic. Lift the door from the bottom hinge pin.

NOTE: Remove the hinge pin cover from the bottom hinge pin and keep it for later use. See Bottom Hinge graphic.

Reverse Door - Standard Door (optional)

IMPORTANT: If you want to reverse your door so it opens from the opposite side, follow these steps. If you are not reversing the door, see "Replace Door(s) and Hinges."



Door Stop Screw



Door Handle Seal Screw Front



Flat-Head Handle Screw



Cabinet Hinge Hole Plug

Cabinet

1. Remove hinge screws from handle side and move them to opposite side. See Graphic 1.

Refrigerator door

1. Remove the refrigerator handle assembly as shown in Graphic 2. Keep all parts together.
2. Remove door handle seal screw front. Move to opposite side of refrigerator door as shown in Graphic 5.
3. Remove the door stop. Move it to the opposite side of the refrigerator door as shown in Graphic 3.
4. Attach refrigerator handle on opposite side of the refrigerator door with the two screws as shown in Graphic 2. Replace handle trim as shown.
5. Tighten all screws. Set aside the door until hinges and freezer compartment drawer are in place.

Freezer door

1. Remove the freezer handle assembly as shown in Graphic 4. Keep all parts together.
2. Remove door stop. Move to opposite side of freezer door as shown in Graphic 3.
3. Attach handle to opposite side of freezer door.
4. Tighten all screws. Set the door aside.
5. Remove the base grille by grasping the grille firmly with both hands and pulling it toward you.
NOTE: Place a shim under the bottom front edge of the refrigerator cabinet to take the weight off the roller brackets.
6. Remove the screws from both roller brackets. See Graphic 6.
7. Remove the hinge plate located behind the roller bracket and move it to the opposite side of the refrigerator. Move the hinge pin and shim to the outside hole on the hinge plate. See Graphic 6.

Replace Doors and Hinges

Standard Door

NOTE: Graphics may be reversed if door swing is reversed. Freezer drawer models

1. Replace the parts for the bottom hinge as shown. Tighten screws.
NOTE: Provide additional support for the door while the hinges are being moved. Do not depend on the door gasket magnets to hold the door in place while you are working.
2. Assemble the parts for the top hinge as shown in Top Hinge graphic. Do not tighten screws completely.
3. Adjust the door so that the bottom of the refrigerator door is aligned with the top of the freezer drawer. Tighten all screws.

Freezer door models

1. Make sure the hinge plate is securely fastened behind the roller bracket and that the hinge pin is inserted into the outside hole. Fully tighten all roller bracket screws. See Graphic 6.
2. Remove the shim that you placed under the front edge of the refrigerator cabinet. Replace the freezer door.
NOTE: Provide additional support for the door while the hinges are being moved. Do not depend on the door gasket magnets to hold the door in place while you are working.
3. Assemble the parts for the center hinge as shown in the Center Hinge graphic, and tighten all the screws. Replace the refrigerator door.
4. Assemble the parts for the top hinge as shown in the Top Hinge graphic. Do not tighten the screws completely.
5. Adjust the doors so that the bottom of the refrigerator door is aligned with the top of the freezer door. Tighten all screws.

French Doors

1. Assemble the parts for the top hinges as shown in Top Hinge graphic. Do not tighten the screws completely.
2. Replace the parts for the bottom hinges as shown in Bottom Hinge graphic. Tighten screws. Replace the refrigerator doors.
NOTE: Provide additional support for the refrigerator doors while the hinges are being moved. Do not depend on the door gasket magnets to hold the doors in place while you are working.
3. Align each door so that the bottom of the refrigerator door aligns evenly with the top of the freezer drawer. Tighten all screws.
4. Reconnect the wiring plug on top of the left-hand side refrigerator door.
5. Replace the top hinge covers.

Remove and Replace Freezer Drawer

IMPORTANT:

- Two people may be required to remove and replace the freezer drawer.
- All graphics are included later in this section after “Final Steps.”

Remove Drawer Front

1. Open the freezer drawer to full extension.
2. Loosen the four screws attaching the drawer glides to the drawer front. See Drawer Front Removal graphic.
NOTE: Loosen screws three to four turns. Keep the screws in the drawer front.
3. Lift drawer front upward and off the screws. See Drawer Front Removal graphic.

Replace Drawer Front

1. Slide the drawer glides out of the freezer compartment. Insert the screws in the top of the drawer front into the slots in the drawer brackets. See Drawer Front Replacement graphic.
2. Pull the drawer brackets toward you to insert the two screws in the bottom of the drawer front into the brackets. See Drawer Front Replacement graphic.
3. Completely tighten the four screws.

Final Steps

1. Check all holes to make sure that hole plugs and screws are in place. Reinstall top hinge cover as shown in Top Hinge graphic.
2. Replace the base grille.

⚠ WARNING



Electrical Shock Hazard

Plug into a grounded 3 prong outlet.

Do not remove ground prong.

Do not use an adapter.

Do not use an extension cord.

Failure to follow these instructions can result in death, fire, or electrical shock.

3. Plug into a grounded 3 prong outlet.
4. Return all removable door parts to door and food to refrigerator.

Door Removal & Replacement

Top Hinge

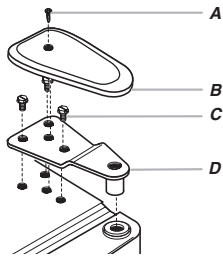

- A. Hinge Cover Screw
- B. Top Hinge Cover
- C. 5/16" Hex-Head Hinge Screws
- D. Top Hinge

Center Hinge

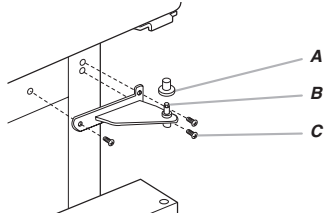

- A. Hinge Pin Cover
- C. Hinge Screws
- B. Center Hinge

Bottom Hinge

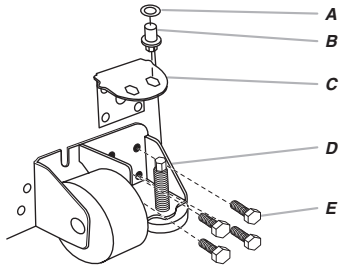

- A. Hinge Pin Shim
- B. Bottom Hinge
- C. Hinge Plate
- D. Roller Bracket
- E. 3/8" Hex-Head Hinge Screws

Door Swing Reversal (optional)

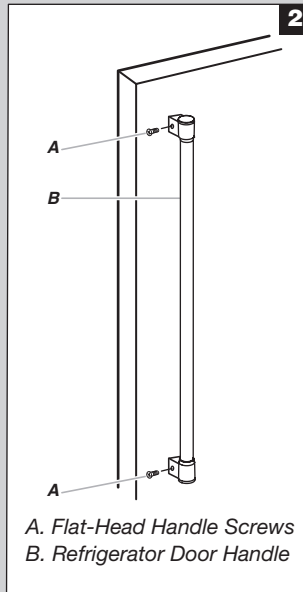

- A. Flat-Head Handle Screws
- B. Refrigerator Door Handle

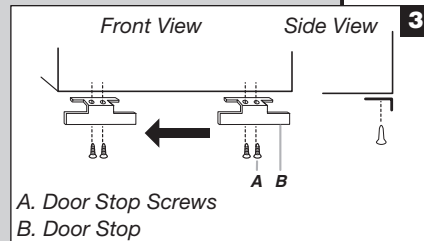

- A. Door Stop Screws
- B. Door Stop

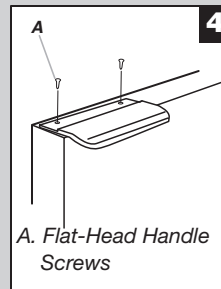

- A. Flat-Head Handle Screws

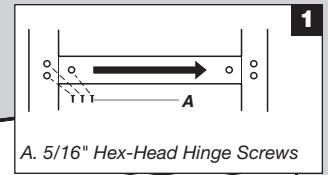

- A. 5/16" Hex-Head Hinge Screws

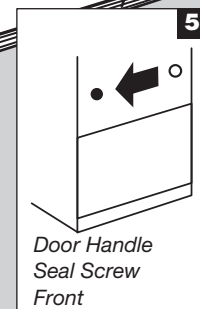

- Door Handle Seal Screw Front

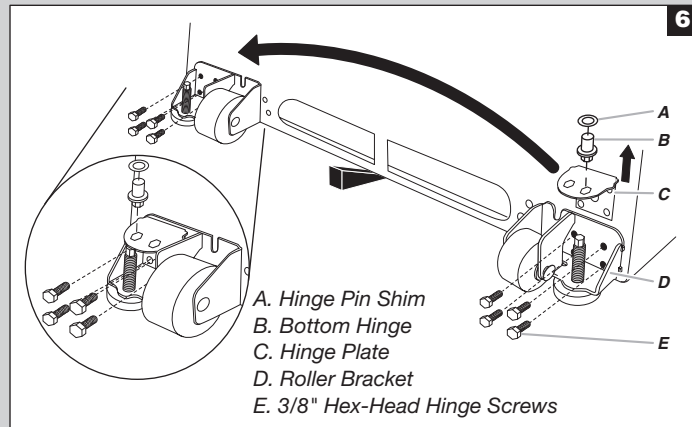

- A. Hinge Pin Shim
- B. Bottom Hinge
- C. Hinge Plate
- D. Roller Bracket
- E. 3/8" Hex-Head Hinge Screws

Door Removal & Replacement

Top Hinge

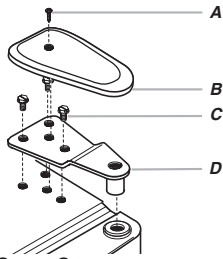

- A. Hinge Cover Screw
- B. Top Hinge Cover
- C. 5/16" Hex-Head Hinge Screws
- D. Top Hinge

Bottom Hinge

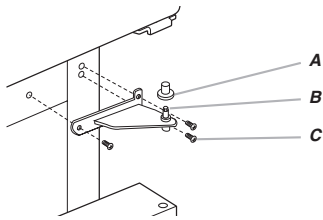

- A. Hinge Pin Cover
- C. Hinge Screws
- B. Center Hinge

Door Swing Reversal (optional)

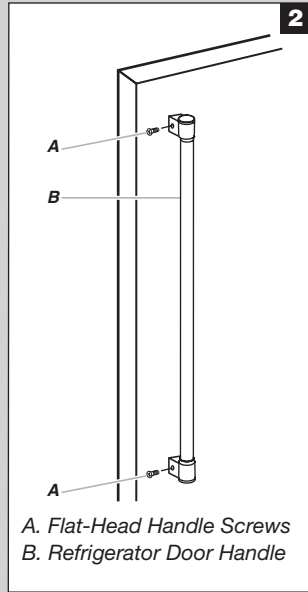

- A. Flat-Head Handle Screws
- B. Refrigerator Door Handle

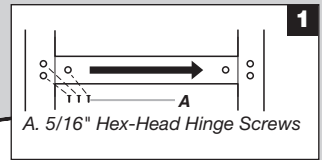

- A. 5/16" Hex-Head Hinge Screws

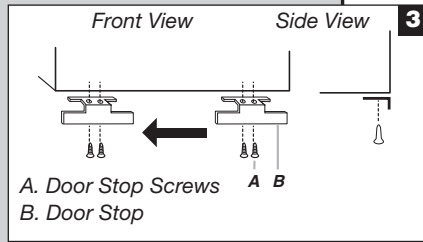

- A. Door Stop Screws
- B. Door Stop

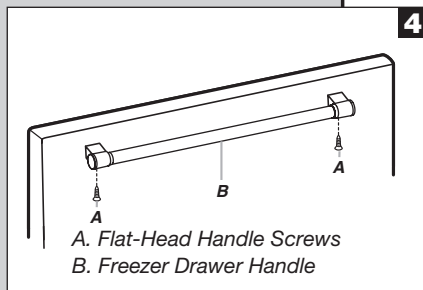

- A. Flat-Head Handle Screws
- B. Freezer Drawer Handle



- Door Handle Seal Screw Front

Drawer Front Removal

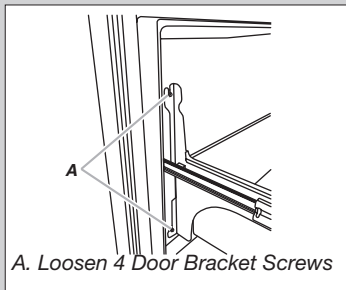

- A. Loosen 4 Door Bracket Screws

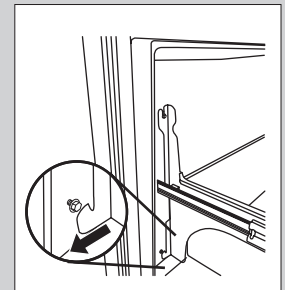
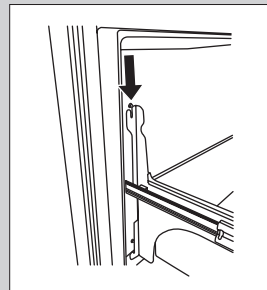
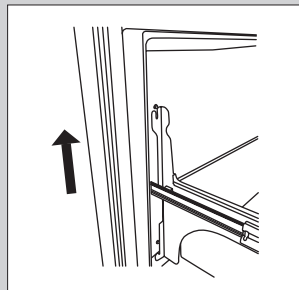

Drawer Front Replacement



WARNING

Electrical Shock Hazard

Disconnect power before removing doors.
Failure to do so can result in death or electrical shock.

Door Removal and Replacement

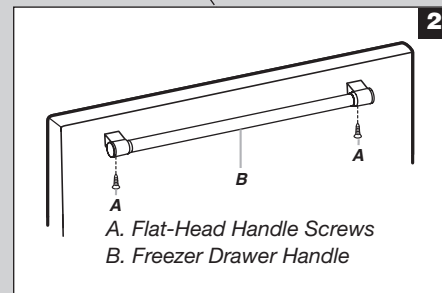
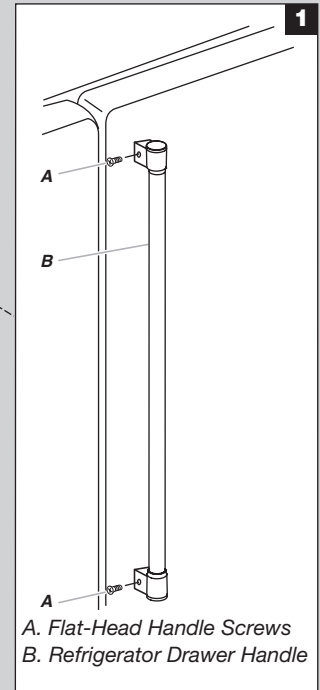
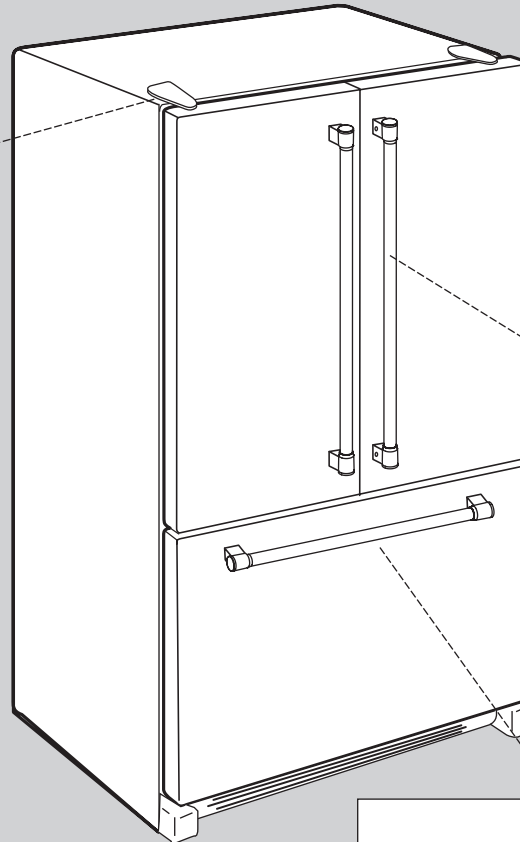
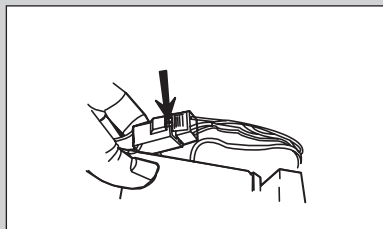
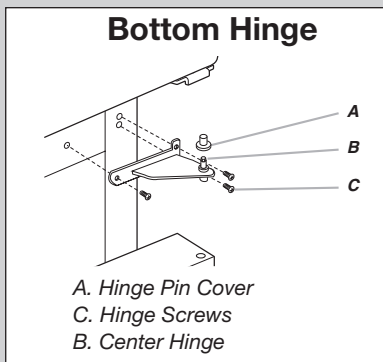
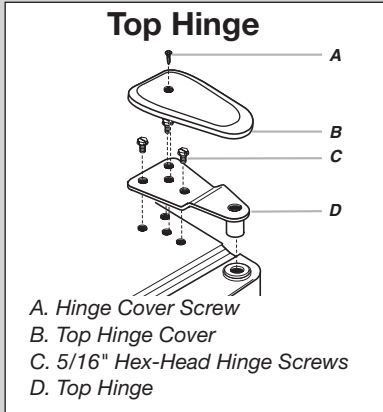

Drawer Front Removal

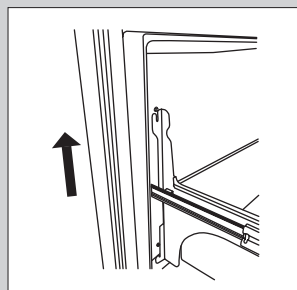
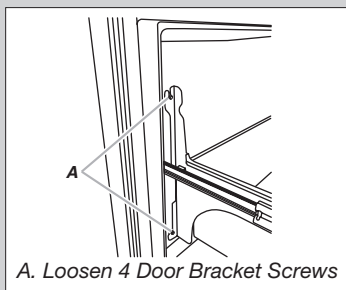

Drawer Front Replacement

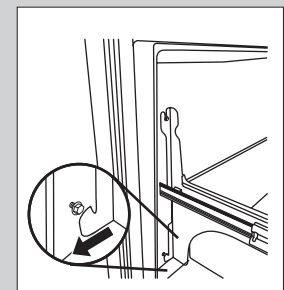
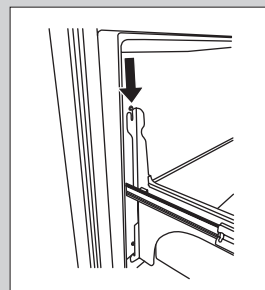

Door Closing and Door Alignment

The base grille covers the leveling screws and roller assemblies located at the bottom of the refrigerator cabinet below the freezer door or drawer. Before making adjustments, remove the base grille and move the refrigerator to its final location.

1. Remove the two screws fastening the base grille to the cabinet, and set the screws aside. Grasp the grille and pull it toward you.

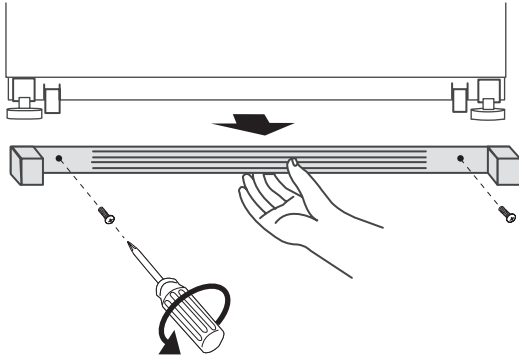

2. Move the refrigerator to its final location.

NOTE: To allow the refrigerator to roll easier, raise the leveling legs off the floor by turning the leveling screws counterclockwise. The front rollers will be touching the floor.

3. So the doors will close easier, use a 1/4" hex driver to turn both leveling screws clockwise. This will raise the front of the refrigerator tilting it slightly downward to the rear. Turn both leveling screws the same amount.

NOTE: Having someone push against the top of the refrigerator takes some weight off the leveling screws. This makes it easier to turn the screws.

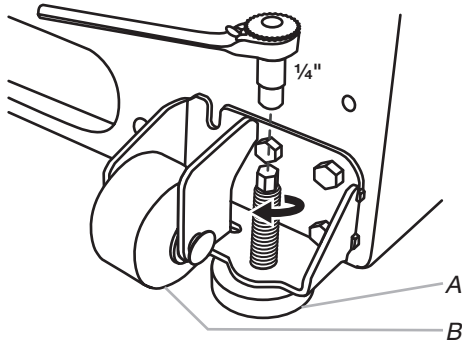

A. Leveling screw
B. Front roller

4. Open and close the doors to make sure they close as easily as you like. If not, increase the tilt by turning both leveling screws clockwise. It may take several turns of the leveling screw to allow the doors to close easier.
5. Check for door alignment. If one door is lower than the other, adjust the leveling screw, on the lower side of the refrigerator. Using a 1/4" hex driver, turn the screw clockwise to raise that side of the refrigerator until the doors are aligned. It may take several turns of the leveling screw to raise the refrigerator.

NOTE: Having someone push against the top of the refrigerator takes some weight off the leveling screws. This makes it easier to turn the screws.

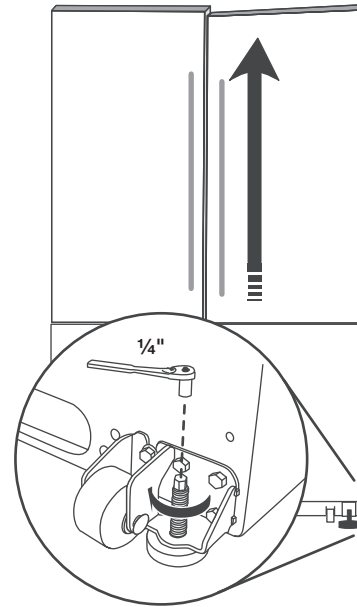

6. Make sure the refrigerator is steady. If the refrigerator seems unsteady or rolls forward when the door or drawer is opened adjust the leveling screws. Using a 1/4" hex driver, turn the leveling screw on each side clockwise until the rollers are up and the leveling feet are firmly against the floor.
7. Replace the base grille by aligning the holes in the grille with the holes in the cabinet and fasten using the screws removed in Step 1.

REFRIGERATOR USE

Opening and Closing Doors (French door models)

There are two refrigerator compartment doors. The doors can be opened and closed either separately or together.

There is a vertically-hinged seal on the left refrigerator door.

- When the left-hand refrigerator door is opened, the hinged seal automatically folds inward so that it is out of the way.
- When both doors are closed, the hinged seal automatically forms a seal between the two doors.

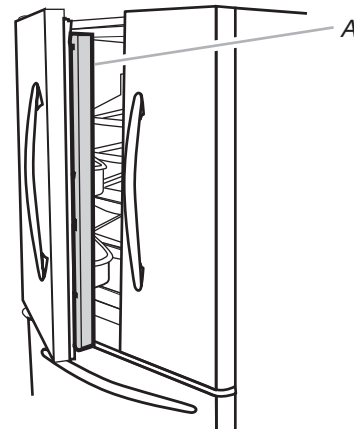

A. Hinged seal

Using the Controls

Your model may have either Electronic or Digital Controls.

IMPORTANT:

- Wait 24 hours for your refrigerator to cool completely before adding food. If you add food before the refrigerator has cooled completely, your food may spoil.

NOTE: Adjusting the Refrigerator and Freezer Controls to a higher (colder) than recommended setting will not cool the compartments any faster.

- The recommended settings should be correct for normal household refrigerator use. The controls are set correctly when milk or juice is as cold as you like and when ice cream is firm.
- If the temperature is too warm or too cold in the refrigerator or freezer, first check the air vents to be sure they are not blocked before adjusting the controls.

Electronic Controls

For your convenience, the temperature controls are preset at the factory. When you first install your refrigerator, make sure the controls are still set to the recommended setting as shown.

Style 1

Recommended Setting "4"

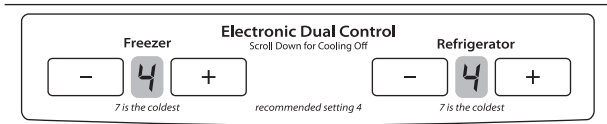

Style 2

Recommended Setting "4"



To Turn Off/On:

Style 1—Press the freezer minus sign touch pad until a dash (-) appears in both the refrigerator and freezer displays.

Neither compartment will cool.

Style 2—Press the freezer down arrow touch pad until a dash (-) appears in both the refrigerator and freezer displays. Neither compartment will cool.

Humidity Control (on some models)

The humidity control turns on a heater to help reduce moisture on the door hinge seal. Use in humid environments or when you notice moisture on the door hinge seal. The refrigerator uses more energy when Humidity Control is on.

- Press the control to ON when the environment is warm and more humid, or if you notice moisture on the door hinge seal.
- Press the control to OFF to save energy when the environment is less humid.



Adjusting Controls

If you need to adjust the temperature in either the refrigerator or freezer compartment, use the settings listed in the chart below as a guide.

To adjust the temperature:

Style 1—Press the up or down arrow touch pads

Style 2—Press the plus or minus sign touch pads.

Except when first turning on the refrigerator, do not adjust the control more than one setting at a time. Wait 24 hours between adjustments for the temperature to stabilize.

CONDITION/REASON:	ADJUSTMENT:
REFRIGERATOR too warm	REFRIGERATOR Control one setting higher
FREEZER too warm/too little ice	FREEZER Control one setting higher
REFRIGERATOR too cold	REFRIGERATOR Control one setting lower
FREEZER too cold	FREEZER Control one setting lower

Digital Controls

For your convenience, your temperature controls are preset at the factory. When you first install your refrigerator, make sure the controls are still set to the Initial settings as shown.

Initial Settings



IMPORTANT: When the power is on, the temperature display shows the set point temperature of the compartment.

To Turn Your Refrigerator Off/On:

- Press both the freezer and refrigerator (+) touch pads repeatedly until "OFF" appears in the displays. Allow a few seconds for the refrigerator to shut off. Neither compartment will cool.
- Press both the refrigerator and freezer (-) touch pads to turn on the refrigerator.

Adjusting Digital Controls

The REFRIGERATOR control adjusts the refrigerator compartment temperature. The FREEZER control adjusts the freezer compartment temperature.

If you need to adjust the temperature in either the refrigerator or freezer compartment, use the settings listed in the chart as a guide.

To Adjust Set Point Temperatures:

The first touch of the (+) or (-) touch pad displays the current temperature set point.

- Press the (+) or (-) touch pads until the desired temperature set point is displayed.

NOTE: Except when first turning on the refrigerator, do not adjust either temperature control more than one setting at a time. Wait 24 hours between adjustments for the temperature to stabilize.

Additional Digital Control Center Features

PowerCold®

The PowerCold® feature assists with periods of high refrigerator use, full grocery loads, or temporarily warm room temperatures.

- Press the PowerCold® touch pad to set the freezer and refrigerator to the lowest temperature settings. Press the PowerCold® touch pad again to return to the normal refrigerator set point.

NOTE: The PowerCold® feature will automatically shut off in approximately 12 hours.



Max Ice

The Max Ice feature assists with temporary periods of heavy ice use by increasing ice production.

- Press the Max Ice touch pad to set the freezer to the lowest temperature setting. Press the Max Ice touch pad again to return to the normal freezer set point.

NOTE: When Max Ice is on, the (+) and (-) pads for the freezer control will not operate. The Max Ice feature will automatically shut off in approximately 24 hours.



Humidity Control

The Humidity Control feature turns on a heater to help reduce moisture on the door hinge seal. Use in humid environments or when you notice moisture on the door hinge seal. The refrigerator uses more energy when Humidity Control is on.

- Press Humidity Control when the environment is warm and more humid, or if you notice moisture on the door hinge seal. The indicator light will be lit when humidity control is ON.
- Press Humidity Control to save energy when the environment is less humid.



Temp Alarm

The Temp Alarm feature provides temperature information in the event of a power outage.

Power outage: During a power outage, if the temperatures in the refrigerator and freezer compartments exceed normal operating temperatures, the highest temperature reached will be displayed.

- Press the Temp Alarm touch pad until the indicator light is lit, to turn on this feature. Press and hold Temp Alarm for 3 seconds until the indicator light goes off to turn off this feature.

Temp Alarm: An alarm will sound repeatedly if the freezer or refrigerator compartment temperatures exceed normal operating temperatures for an hour or more.

The temperature displays will alternately show the current temperatures and the highest temperatures the compartments reached.

- Press the Temp Alarm touch pad once to stop the audible alarm and alternating temperature displays. The Temp Alarm light will continue to flash until the refrigerator returns to the set temperature.



Door Alarm

The Door Alarm feature sounds a chime every few seconds when the refrigerator door has been left open for 5 continuous minutes. The chime will sound until the door is closed or Door Alarm is turned off.

- Press the Door Alarm touch pad to turn this feature on or off. The indicator light will be lit when the Door Alarm feature is on.



Filter Reset

The Filter Reset control allows you to restart the water filter status tracking feature each time you replace your water filter. See "Water Filtration System."

- Press and hold the Filter Reset touch pad for 3 seconds, until the Order or Replace light turns off.



Digital Control User Preferences

The control center allows you to set user preferences, if desired.

Temperature Display (F_C)

This preference allows you to change the temperature display.

F - Temperature in degrees Fahrenheit

C - Temperature in degrees Celsius

Alarm (AL)

This preference allows you to turn off the sound of all alarms.

ON - You will hear the alarm sound.

OFF - You will not hear the alarm sound.

To Access the User Preferences Menu:

1. Press and hold the Door Alarm touch pad for 3 seconds. The preference name will appear in the Freezer display and the preference status (F or C) or (ON or OFF) will appear in the Refrigerator display.
2. Use the Freezer (+) or (-) touch pads to scroll through the preference names. When the desired preference name is displayed, press the Refrigerator (+) or (-) touch pads to change the preference status.
3. Set your preferences by pressing and holding the Door Alarm touch pad for 3 seconds, or by shutting the refrigerator compartment door.

Crisper Humidity Control

You can control the amount of humidity in the moisture-sealed crisper. Depending on your model, adjust the control to any setting between FRUIT and VEGETABLES or LOW and HIGH.

FRUIT/LOW (open) for best storage of fruits and vegetables with skins.

VEGETABLES/HIGH (closed) for best storage of fresh, leafy vegetables.

Ice Maker

IMPORTANT: Flush the water system before turning on the ice maker. See “Water Dispenser.”

Turning the Ice Maker On/Off

To turn the ice maker ON, simply lower the wire shutoff arm.

To manually turn the ice maker OFF, lift the wire shutoff arm to the OFF (arm up) position and listen for the click.

NOTE: Your ice maker has an automatic shutoff. As ice is made, the ice cubes will fill the ice storage bin and the ice cubes will raise the wire shutoff arm to the OFF (arm up) position. Do not force the wire shutoff arm up or down.

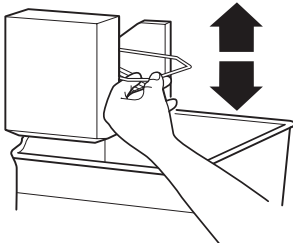

NOTE: Turn off the ice maker before removing the ice storage bin to serve ice or to clean the bin. This will keep the ice cubes from dropping out of the ice maker and into the freezer compartment. After replacing the ice storage bin, turn on the ice maker.

Ice Production Rate

- The ice maker should produce a complete batch of ice approximately every 3 hours.
- To increase ice production, lower the freezer and refrigerator temperature. See “Using the Controls.” Wait 24 hours between adjustments.

Remember

- Allow 24 hours to produce the first batch of ice. Discard the first three batches of ice produced. Allow 3 days to completely fill the ice storage bin.
- The quality of your ice will be only as good as the quality of the water supplied to your ice maker. Avoid connecting the ice maker to a softened water supply. Water softener chemicals (such as salt) can damage parts of the ice maker and lead to poor quality ice. If a softened water supply cannot be avoided, make sure the water softener is operating properly and is well maintained.
- Do not store anything on top of the ice maker or in the ice storage bin.

Water Dispenser

IMPORTANT:

- After connecting the refrigerator to a water source or replacing the water filter, flush the water system. Use a sturdy container to depress and hold the water dispenser lever for 5 seconds, then release it for 5 seconds. Repeat until water begins to flow. Once water begins to flow, continue depressing and releasing the dispenser paddle (5 seconds on, 5 seconds off) until a total of 4 gal. (15 L) has been dispensed. This will flush air from the filter and water dispensing system, and prepare the water filter for use. Additional flushing may be required in some households. As air is cleared from the system, water may spurt out of the dispenser.

NOTE: After 5 minutes of continuous dispensing, the dispenser will stop dispensing water to avoid flooding. To continue dispensing, press the dispenser paddle again.

- Allow 24 hours for the refrigerator to cool down and chill water. Dispense enough water every week to maintain a fresh supply.

Dispensing Water

1. Hold a container under the dispenser spout while pressing the dispenser pad.
2. Release the dispenser pad to stop dispensing.

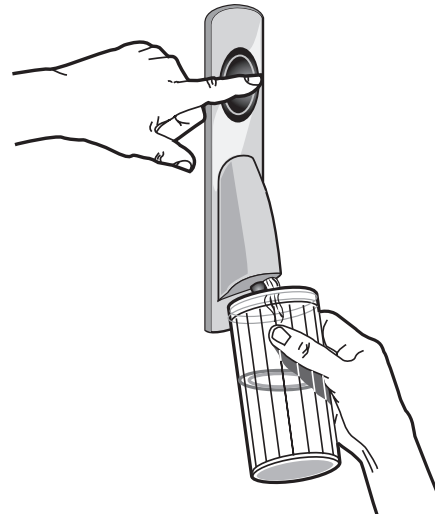

Water Filtration System

The water filter is located in the upper right-hand corner of the refrigerator compartment.

Do not use with water that is microbiologically unsafe or of unknown quality without adequate disinfection before or after the system. Systems certified for cyst reduction may be used on disinfected waters that may contain filterable cysts.

Water Filter Status Lights

When a water filter has been installed in the refrigerator the water filter status lights will remind you when it is time to order and replace your water filter.

- The Order light (yellow) will illuminate when 90% of the volume of water for which the filter is rated has passed through the filter OR 5 months have passed since the filter was installed.
- The Replace light (red) will illuminate when the rated volume of water has passed through the filter OR 6 months have passed since the filter was installed. A new water filter should be installed immediately when the Replace light is illuminated.

The disposable water filter should be replaced at least every 6 months OR earlier if the flow of water to your water dispenser or ice maker decreases noticeably.

Reset Water Filter Status

After replacing the water filter, press and hold Reset Filter or Filter Reset (depending on your model) for 3 seconds. The Order and Replace indicator lights will blink and then go off when the system is reset. See "Using the Controls."

Replacing the Water Filter

To purchase a replacement water filter, model UKF8001AXX-750 or UKF8001AXX-200, see "Accessories."

IMPORTANT: Air trapped in the water system may cause water and filter to eject. Always dispense water for at least 2 minutes before removing the filter or blue bypass cap.

1. Turn filter counterclockwise to remove.
2. Remove sealing label from replacement filter and insert the filter end into the filter head.
3. Turn the filter clockwise until it stops. Snap the filter cover closed.
4. Flush the water system. See "Water Dispenser" or "Water and Ice Dispenser."

NOTE: The dispenser feature may be used without a water filter installed. Your water will not be filtered. If this option is chosen, replace the filter with the blue bypass cap.

REFRIGERATOR CARE

Cleaning

WARNING



Explosion Hazard

Use nonflammable cleaner.

Failure to do so can result in death, explosion, or fire.

Both the refrigerator and freezer sections defrost automatically. However, clean both sections about once a month to avoid buildup of odors. Wipe up spills immediately.

IMPORTANT:

- Because air circulates between both sections, any odors formed in one section will transfer to the other. You must thoroughly clean both sections to eliminate odors. To avoid odor transfer and drying out of food, wrap or cover foods tightly.
- For stainless steel models, stainless steel is corrosion resistant and not corrosion-proof. To help avoid corrosion of your stainless steel, keep your surfaces clean by using the following cleaning instructions.

To Clean Your Refrigerator:

NOTE: Do not use abrasive or harsh cleaners such as window sprays, scouring cleansers, flammable fluids, cleaning waxes, concentrated detergents, bleaches or cleansers containing petroleum products on plastic parts, interior and door liners or gaskets. Do not use paper towels, scouring pads, or other harsh cleaning tools.

1. Unplug refrigerator or disconnect power.
2. Hand wash, rinse, and dry removable parts and interior surfaces thoroughly. Use a clean sponge or soft cloth and a mild detergent in warm water.
3. Clean the exterior surfaces.

Painted metal: Wash painted metal exteriors with a clean, soft cloth or sponge and a mild detergent in warm water. Rinse surfaces with clean, warm water and dry immediately to avoid water spots.

Stainless steel: Wash stainless steel surfaces with a clean, soft cloth or sponge and a mild detergent in warm water. Rinse surfaces with clean, warm water and dry immediately to avoid water spots.

NOTE: When cleaning stainless steel, always wipe in the direction of the grain to avoid cross-grain scratching.

4. There is no need for routine condenser cleaning in normal home operating environments. If the environment is particularly greasy or dusty, or there is significant pet traffic in the home, the condenser should be cleaned every 2 to 3 months to ensure maximum efficiency.

If you need to clean the condenser:

- Remove the base grille.
 - Use a vacuum cleaner with a soft brush to clean the grille, the open areas behind the grille and the front surface area of the condenser.
 - Replace the base grille when finished.
5. Plug in refrigerator or reconnect power.

Changing the Light Bulb

IMPORTANT: The light bulbs in both the refrigerator and freezer compartments use LED bulbs, incandescent bulbs or a combination of the two. If the lights do not illuminate when the refrigerator and/or freezer door is opened, call for assistance or service. See “Warranty” for phone numbers.

1. Unplug the refrigerator or disconnect power.
2. Remove the light shield (on some models).
 - Top of the refrigerator compartment - Slide the light shield toward the back of the compartment to release it from the light assembly.

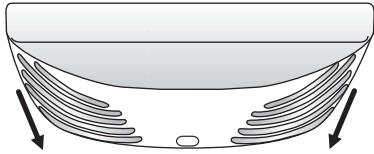

3. Replace the burned-out bulb(s) with a bulb of the same size, shape and wattage.

- To replace the burned-out LED bulb with an LED bulb, order Part Number W10565137 (3.6 watts).

NOTE: Some LED replacement bulbs are not recommended for wet/damp environments. The refrigerator and freezer compartments are considered to be wet/damp environments. If using a brand of LED bulb other than the recommended LED bulb, before installation, read and follow all instructions on the LED packaging.

- When replacing an incandescent bulb, use only incandescent bulbs for household appliances with a maximum of 40 watts. Replace bulb shield/shroud after replacing incandescent bulb.

Vacation and Moving Care

Vacations

If You Choose to Leave the Refrigerator On While You're Away:

1. Use up any perishables and freeze other items.
2. If your refrigerator has an automatic ice maker, and is connected to the household water supply, turn off the water supply to the refrigerator. Property damage can occur if the water supply is not turned off.
3. If you have an automatic ice maker, turn off the ice maker.

NOTE: Depending on your model, raise the wire shutoff arm to OFF (up) position, or press the switch to OFF.
4. Empty the ice bin.

If You Choose to Turn Off the Refrigerator Before You Leave:

1. Remove all food from the refrigerator.
2. If your refrigerator has an automatic ice maker:
 - Turn off the water supply to the ice maker at least one day ahead of time.
 - When the last load of ice drops, raise the wire shutoff arm to the OFF (up) position or press the switch to OFF, depending on your model.
3. Turn off the Temperature control(s). See “Using the Control(s).”
4. Clean refrigerator, wipe it, and dry well.
5. Tape rubber or wood blocks to the tops of both doors to prop them open far enough for air to get in. This stops odor and mold from building up.

Moving

When you are moving your refrigerator to a new home, follow these steps to prepare it for the move.

1. If your refrigerator has an automatic ice maker:
 - Turn off the water supply to the ice maker at least one day ahead of time.
 - Disconnect the water line from the back of the refrigerator.
 - When the last load of ice drops, raise the wire shutoff arm to the OFF (up) position or press the switch to OFF, depending on your model.
2. Remove all food from the refrigerator and pack all frozen food in dry ice.
3. Empty the ice bin.
4. Turn off the Temperature control(s). See “Using the Control(s).”
5. Unplug refrigerator.
6. Clean, wipe, and dry thoroughly.
7. Take out all removable parts, wrap them well, and tape them together so they don't shift and rattle during the move.
8. Depending on the model, raise the front of the refrigerator so it rolls more easily OR raise the leveling screws so they don't scrape the floor. See “Adjust the Door(s)” or “Door Closing and Door Alignment.”
9. Tape the doors closed and tape the power cord to the back of the refrigerator.

When you get to your new home, put everything back and refer to the “Installation Instructions” section for preparation instructions. Also, if your refrigerator has an automatic ice maker, remember to reconnect the water supply to the refrigerator.

TROUBLESHOOTING

First try the solutions suggested here. If you need further assistance or more recommendations that may help you avoid a service call, refer to the warranty page in this manual, or visit www.maytag.com/product_help. In Canada, visit www.maytag.ca.

Contact us by mail with any questions or concerns at the address below:

Maytag Brand Home Appliances
Customer eXperience Center
553 Benson Road
Benton Harbor, MI 49022-2692

Maytag Brand Home Appliances
Customer eXperience Centre
200 – 6750 Century Ave.
Mississauga, Ontario L5N 0B7

Please include a daytime phone number in your correspondence.

Refrigerator Operation

The refrigerator will not operate

⚠ WARNING



Electrical Shock Hazard

Plug into a grounded 3 prong outlet.

Do not remove ground prong.

Do not use an adapter.

Do not use an extension cord.

Failure to follow these instructions can result in death, fire, or electrical shock.

- **Power cord unplugged?** Plug into a grounded 3 prong outlet.
- **Is outlet working?** Plug in a lamp to see if the outlet is working.
- **Household fuse blown or circuit breaker tripped?** Replace the fuse or reset the circuit breaker. If the problem continues, call an electrician.
- **Are controls on?** Make sure the refrigerator controls are on. See “Using the Control(s).”
- **New installation?** Allow 24 hours following installation for the refrigerator to cool completely.
NOTE: Adjusting the temperature controls to coldest setting will not cool either compartment more quickly.

The motor seems to run too much

Your new refrigerator may run longer than your old one due to its high-efficiency compressor and fans. The unit may run even longer if the room is warm, a large food load is added, doors are opened often, or if the doors have been left open.

The refrigerator seems noisy

Refrigerator noise has been reduced over the years. Due to this reduction, you may hear intermittent noises from your new refrigerator that you did not notice from your old model. Below are listed some normal sounds with explanations.

- **Buzzing** - heard when the water valve opens to fill the ice maker
- **Pulsating** - fans/compressor adjusting to optimize performance
- **Hissing/Rattling** - flow of refrigerant, movement of water lines, or from items placed on top of the refrigerator
- **Sizzling/Gurgling** - water dripping on the heater during defrost cycle
- **Popping** - contraction/expansion of inside walls, especially during initial cool-down
- **Water running** - may be heard when ice melts during the defrost cycle and water runs into the drain pan
- **Creaking/Cracking** - occurs as ice is being ejected from the ice maker mold.

The doors will not close completely

- **Door blocked open?** Move food packages away from door.
- **Bin or shelf in the way?** Push bin or shelf back in the correct position.

The doors are difficult to open

⚠ WARNING



Explosion Hazard

Use nonflammable cleaner.

Failure to do so can result in death, explosion, or fire.

- **Gaskets dirty or sticky?** Clean gaskets and contact surfaces with mild soap and warm water. Rinse and dry with soft cloth.

Temperature and Moisture

Temperature is too warm

- **New installation?** Allow 24 hours following installation for the refrigerator to cool completely.
- **Door(s) opened often or left open?** Allows warm air to enter refrigerator. Minimize door openings and keep doors fully closed.
- **Large load of food added?** Allow several hours for refrigerator to return to normal temperature.
- **Controls set correctly for the surrounding conditions?** Adjust the controls a setting colder. Check temperature in 24 hours. See “Using the Control(s).”

There is interior moisture buildup

NOTE: Some moisture buildup is normal.

- **Humid room?** Contributes to moisture buildup.
- **Door(s) opened often or left open?** Allows humid air to enter refrigerator. Minimize door openings and keep doors fully closed.

Ice and Water

The ice maker is not producing ice or not enough ice

- **Refrigerator connected to a water supply and the supply shutoff valve turned on?** Connect refrigerator to water supply and turn water shutoff valve fully open.
- **Kink in the water source line?** A kink in the line can reduce water flow. Straighten the water source line.
- **Ice maker turned on?** Make sure wire shutoff arm or switch (depending on model) is in the ON position.
- **New installation?** Wait 24 hours after ice maker installation for ice production to begin. Wait 72 hours for full ice production.
- **Freezer door closed completely?** Firmly close the freezer compartment door. If the freezer compartment door will not close all the way, see “The doors will not close completely,” earlier in this section.
- **Large amount of ice recently removed?** Allow 24 hours for ice maker to produce more ice.
- **Ice cube jammed in the ice maker ejector arm?** Remove ice from the ejector arm with a plastic utensil.
- **Water filter installed on the refrigerator?** Remove filter and operate ice maker. If ice volume improves, then the filter may be clogged or incorrectly installed. Replace filter or reinstall it correctly.
- **Reverse osmosis water filtration system connected to your cold water supply?** This can decrease water pressure. See “Water Supply Requirements.”

The ice cubes are hollow or small

NOTE: This is an indication of low water pressure.

- **Water shutoff valve not fully open?** Turn the water shutoff valve fully open.
- **Kink in the water source line?** A kink in the line can reduce water flow. Straighten the water source line.
- **Water filter installed on the refrigerator?** Remove filter and operate ice maker. If ice quality improves, then the filter may be clogged or incorrectly installed. Replace filter or reinstall it correctly.
- **Reverse osmosis water filtration system connected to your cold water supply?** This can decrease water pressure. See “Water Supply Requirements.”
- **Questions remain regarding water pressure?** Call a licensed, qualified plumber.

Off-taste, odor or gray color in the ice

- **New plumbing connections?** New plumbing connections can cause discolored or off-flavored ice.
- **Ice stored too long?** Discard ice. Wash ice bin. Allow 24 hours for ice maker to make new ice.
- **Odor transfer from food?** Use airtight, moisture proof packaging to store food.
- **Are there minerals (such as sulfur) in the water?** A water filter may need to be installed to remove the minerals.
- **Water filter installed on the refrigerator?** Gray or dark discoloration in ice indicates that the water filtration system needs additional flushing. Flush the water system before using a new water filter. Replace water filter when indicated. See “Water Filtration System.”

The water dispenser will not operate properly

- **Refrigerator connected to a water supply and the supply shutoff valve turned on?** Connect refrigerator to water supply and turn water shutoff valve fully open.
- **Kink in the water source line?** Straighten the water source line.
- **New installation?** Flush and fill the water system. See “Water Dispenser.”
- **Is the water pressure at least 35 psi (241 kPa)?** The water pressure to the home determines the flow from the dispenser. See “Water Supply Requirements.”
- **Water filter installed on the refrigerator?** Remove filter and operate dispenser. If water flow increases, the filter may be clogged or incorrectly installed. Replace filter or reinstall it correctly.
- **Refrigerator door closed completely?** Close the door firmly. If it does not close completely, see “The doors will not close completely,” earlier in this section.
- **Recently removed the doors?** Make sure the water dispenser wire/tube assembly has been properly reconnected. See “Refrigerator Door(s) and Drawer.”
- **Reverse osmosis water filtration system connected to your cold water supply?** This can decrease water pressure. See “Water Supply Requirements.”

Water is leaking from the dispenser system

NOTE: One or two drops of water after dispensing is normal.

- **Glass not being held under the dispenser long enough?** Hold the glass under the dispenser 2 to 3 seconds after releasing the dispenser lever.
- **New installation?** Flush the water system. See “Water Dispenser.”
- **Recently changed water filter?** Flush the water system. See “Water Dispenser.”
- **Water on the floor near the base grille?** Make sure the water dispenser tube connections are fully tightened. See “Refrigerator Door(s) and Drawer.”

Water from the dispenser is warm

NOTE: Water from the dispenser is only chilled to 50°F (10°C).

- **New installation?** Allow 24 hours after installation for the water supply to cool completely.
- **Recently dispensed large amount of water?** Allow 24 hours for water supply to cool completely.
- **Water not been recently dispensed?** The first glass of water may not be cool. Discard the first glass of water.
- **Refrigerator connected to a cold water pipe?** Make sure the refrigerator is connected to a cold water pipe. See “Water Supply Requirements.”

Accessories

The following accessories are available for your refrigerator. To order an accessory, contact us and ask for the part number.

In the U.S.A., visit our webpage www.maytag.com/accessories or call 1-800-901-2042.

In Canada, visit our web page www.maytag.ca or call 1-800-807-6777.

Affresh® Stainless Steel Cleaner:

In U.S.A., order Part #W10355016
In Canada, order Part #W10355016B

WATER FILTER CERTIFICATIONS

Affresh® Stainless Steel Wipes:

In U.S.A., order Part #W10355049
In Canada, order Part #W10355049B

Affresh® Kitchen & Appliance Cleaner:

In U.S.A., order Part #W10355010
In Canada, order Part #W10355010B

Water Filter:

Order Part #UKF8001AXX-750 or Part #UKF8001AXX-200

Produce Preserver (on some models):

Order Part #W10346771A

WATER FILTER CERTIFICATIONS

State of California
Department of Public Health
Water Treatment Device
Certificate Number
03 - 1583

Date Issued: September 16, 2008
Date Revised: April 22, 2009

State of California
Department of Public Health
Water Treatment Device
Certificate Number
09 - 1979

Date Issued: May 8, 2009
Date Revised: 6/22/2010

<u>Trademark/Model Designation</u>	<u>Replacement Elements</u>
UKF8001AXX-750	UKF8001
46 9006-750	46 9006
67003523-750	UKF8001

Manufacturer: Cuno Inc.

The water treatment device(s) listed on this certificate have met the testing requirements pursuant to Section 116830 of the Health and Safety Code for the following health related contaminants:

<u>Microbiological Contaminants and Turbidity</u>	<u>Inorganic/Radiological Contaminants</u>
Cysts	Asbestos
Turbidity	Lead
	Mercury

<u>Organic Contaminants</u>
Atrazine
Lindane
Benzene
Carbofuran
p-dichlorobenzene
Toxaphene
Tetrachloroethylene

Rated Service Capacity: 750 gal. **Rated Service Flow:** 0.78 gpm

Conditions of Certification:

Do not use where water is microbiologically unsafe or with water of unknown quality, except that systems certified for cyst reduction may be used on disinfected waters that may contain filterable cysts.

<u>Trademark/Model Designation</u>	<u>Replacement Elements</u>
UKF8001AXX-200	UKF8001
Kenmore 46 9006-200	46 9006

Manufacturer: 3M Purification

The water treatment device(s) listed on this certificate have met the testing requirements pursuant to Section 116830 of the Health and Safety Code for the following health related contaminants:

<u>Microbiological Contaminants and Turbidity</u>	<u>Inorganic/Radiological Contaminants</u>
Cysts	Asbestos
Turbidity	Lead
	Mercury

<u>Organic Contaminants</u>	<u>More Organic Contaminants</u>
Atrazine	o-dichlorobenzene
Benzene	p-dichlorobenzene
Carbofuran	Tetrachloroethylene
Chlorobenzene	Toxaphene
Endrin	2,4-D
Ethylbenzene	
Lindane	

Rated Service Capacity: 200 gal

Rated Service Flow: 0.55 gpm

Conditions of Certification:

Do not use where water is microbiologically unsafe or with water of unknown quality, except that systems certified for cyst reduction may be used on disinfected waters that may contain filterable cysts.

PERFORMANCE DATA SHEETS

Interior Water Filtration System Model UKF8001AXX-750 Capacity 750 Gallons (2839 Liters)



System tested and certified by NSF International against NSF/ANSI Standard 42 for the reduction of Chlorine Taste and Odor, Particulate Class I*; and against NSF/ANSI Standard 53 for the reduction of Lead, Mercury, Atrazine, Benzene, p-Dichlorobenzene, Carbofuran, Toxaphene, Cysts, Turbidity, Asbestos, Tetrachloroethylene and Lindane.

This system has been tested according to NSF/ANSI Standards 42 and 53 for the reduction of the substances listed below. The concentration of the indicated substances in water entering the system was reduced to a concentration less than or equal to the permissible limit for water leaving the system, as specified in NSF/ANSI Standards 42 and 53

Substance Reduction	NSF Reduction Requirements	Average Influent	Influent Challenge Concentration	Maximum Effluent	Average Effluent	Minimum% Reduction	Average% Reduction
Chlorine Taste/Odor Particulate Class I*	50% reduction 85% reduction	2.00 mg/L 14,000,000 #/mL	2.0 mg/L ± 10% At least 10,000 particles/mL	0.06 mg/L 370,000 #/mL**	0.050625 mg/L 196,666 #/mL	97.00% 97.40%	97.52% 99.00%

Contaminant Reduction	NSF Reduction Requirements	Average Influent	Influent Challenge Concentration	Maximum Effluent	Average Effluent	Minimum% Reduction	Average% Reduction
Lead: @ pH 6.5 Lead: @ pH 8.5	0.010 mg/L 0.010 mg/L	0.150 mg/L† 0.150 mg/L†	0.15 mg/L ± 10% 0.15 mg/L ± 10%	< 0.001 mg/L < 0.001 mg/L	< 0.001 mg/L < 0.001 mg/L	>99.30% >99.30%	>99.30% >99.30%
Mercury: @ pH 6.5 Mercury: @ pH 8.5	0.002 mg/L 0.002 mg/L	0.006 mg/L 0.0059 mg/L	0.006 mg/L ± 10% 0.006 mg/L ± 10%	0.0005 mg/L 0.0018 mg/L	0.0003 mg/L 0.00073 mg/L	91.70% 69.20%	95.00% 88.10%
Benzene	0.005 mg/L	0.0133 mg/L	0.015 mg/L ± 10%	0.0005 mg/L	0.0005 mg/L	96.10%	96.30%
p-Dichlorobenzene	0.075 mg/L	0.210 mg/L	0.225 mg/L ± 10%	< 0.0005 mg/L	< 0.0005 mg/L	>99.80%	>99.80%
Carbofuran	0.040 mg/L	0.0753 mg/L	0.08 mg/L ± 10%	0.027 mg/L	0.008 mg/L	64.60%	73.45%
Toxaphene	0.003 mg/L	0.015 mg/L	0.015 ± 10%	< 0.001 mg/L	< 0.001 mg/L	>93.3%	>93.3%
Atrazine	0.003 mg/L	0.0102 mg/L	0.009 mg/L ± 10%	0.0027 mg/L	0.00105 mg/L	76.30%	89.40%
Asbestos	>99%	126.5 MF/L	107 to 108 fibers/L††	< 0.17 MF/L	< 0.17 MF/L	>99.99%	>99.99%
Live Cysts ‡ Turbidity	>99.95% 0.5 NTU	122,500 #/L 10.5 NTU	50,000/L min. 11 ± 1 NTU	< 1 #/L‡ 0.30 NTU	< 1 #/L‡ 0.125 NTU	>99.99% 97.30%	>99.99% 98.80%
Lindane	0.0002 mg/L	0.0019 mg/L	0.002 ± 10%	< 0.00016 mg/L	0.000035 mg/L	91.80%	97.90%
Tetrachloroethylene	0.005 mg/L	0.015 mg/L	0.015 mg/L ± 10%	< 0.0005 mg/L	< 0.0005 mg/L	>96.6%	>96.6%

Test Parameters: pH = 7.5 ± 0.5 unless otherwise noted. Flow = 0.78 gpm (2.9 Lpm). Pressure = 60 psig (413.7 kPa). Temp. = 68°F ± 5°F (20°C ± 3°C).

- It is essential that operational, maintenance, and filter replacement requirements be carried out for the product to perform as advertised.
- The disposable water filter should be replaced at least every 6 months.
- The filter monitor system measures the amount of water that passes through the filter and alerts you to replace the filter. When 90% of the filter's rated life is used, the yellow (Order) light comes on. When 100% of the filter's rated life is used, the red (Replace) light comes on, and it is recommended that you replace the filter. For models without filter status lights, replace the filter every 6 months. Use replacement filter model UKF8001. 2014 suggested retail price of \$44.99 U.S.A./\$49.95 Canada. Prices are subject to change without notice.
- The product is for cold water use only.
- Do not use with water that is microbiologically unsafe or of unknown quality without adequate disinfection before or after the system. Systems certified for cyst reduction may be used on disinfected waters that may contain filterable cysts.
- Refer to the "Water Filtration System" section for the Manufacturer's name and telephone number.
- Refer to the "Warranty" section for the Manufacturer's limited warranty.

Water Supply	City or Well
Water Pressure	35 - 120 psi (241 - 827 kPa)
Water Temperature	33° - 100°F (1° - 38°C)
Service Flow Rate	0.78 gpm (2.9 L/min.) @ 60 psi*

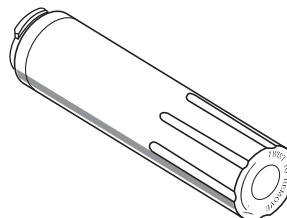

*Class I particle size: >0.5 to <1 µm

**Test requirement is at least 100,000 particles/mL of AC Fine Test Dust

†These contaminants are not necessarily in your water supply. Performance may vary based on local water ††† conditions.

††Fibers greater than 10 µm in length

‡Based on the use of *Cryptosporidium parvum* oocysts

© NSF is a registered trademark of NSF International.

Interior Water Filtration System Model UKF8001AXX-200 Capacity 200 Gallons (757 Liters)



System tested and certified by NSF International against NSF/ANSI Standard 42 for the reduction of Chlorine Taste and Odor, Particulate Class I*; and against NSF/ANSI Standard 53 for the reduction of Lead, Mercury, Atrazine, Benzene, p-Dichlorobenzene, Carbofuran, Toxaphene, Cysts, Turbidity, Asbestos, O-Dichlorobenzene, Ethylbenzene, Chlorobenzene, Endrin, Tetrachloroethylene and Lindane.

This system has been tested according to NSF/ANSI Standards 42 and 53 for the reduction of the substances listed below. The concentration of the indicated substances in water entering the system was reduced to a concentration less than or equal to the permissible limit for water leaving the system, as specified in NSF/ANSI Standards 42 and 53.

Substance Reduction	NSF Reduction Requirements	Average Influent	Influent Challenge Concentration	Maximum Effluent	Average Effluent	Minimum% Reduction	Average% Reduction
Chlorine Taste/Odor Particulate Class I*	50% reduction 85% reduction	2.00 mg/L 14,000,000 #/mL	2.0 mg/L ± 10% At least 10,000 particles/mL	0.06 mg/L 370,000 #/mL**	0.050625 mg/L 196,666 #/mL	97.00% 97.40%	97.52% 99.00%

Contaminant Reduction	NSF Reduction Requirements	Average Influent	Influent Challenge Concentration	Maximum Effluent	Average Effluent	Minimum% Reduction	Average% Reduction
Lead: @ pH 6.5 Lead: @ pH 8.5	0.010 mg/L 0.010 mg/L	0.150 mg/L† 0.150 mg/L†	0.15 mg/L ± 10% 0.15 mg/L ± 10%	< 0.001 mg/L < 0.001 mg/L	< 0.001 mg/L < 0.001 mg/L	>99.30% >99.30%	>99.30% >99.30%
Mercury: @ pH 6.5 Mercury: @ pH 8.5	0.002 mg/L 0.002 mg/L	0.006 mg/L 0.0059 mg/L	0.006 mg/L ± 10% 0.006 mg/L ± 10%	0.0005 mg/L 0.0018 mg/L	0.0003 mg/L 0.00073 mg/L	91.70% 69.20%	95.00% 88.10%
Benzene	0.005 mg/L	0.0133 mg/L	0.015 mg/L ± 10%	0.0005 mg/L	0.0005 mg/L	96.10%	96.30%
p-Dichlorobenzene	0.075 mg/L	0.210 mg/L	0.225 mg/L ± 10%	< 0.0005 mg/L	< 0.0005 mg/L	>99.80%	>99.80%
Carbofuran	0.040 mg/L	0.0753 mg/L	0.08 mg/L ± 10%	0.027 mg/L	0.008 mg/L	64.60%	73.45%
Toxaphene	0.003 mg/L	0.015 mg/L	0.015 ± 10%	< 0.001 mg/L	< 0.001 mg/L	>93.3%	>93.3%
Atrazine	0.003 mg/L	0.0102 mg/L	0.009 mg/L ± 10%	0.0027 mg/L	0.00105 mg/L	76.30%	89.40%
Asbestos	>99%	126.5 MF/L	107 to 108 fibers/L††	< 0.17 MF/L	< 0.17 MF/L	>99.99%	>99.99%
Live Cysts ‡ Turbidity	>99.95% 0.5 NTU	122,500 #/L 10.5 NTU	50,000/L min. 11 ± 1 NTU	< 1 #/L‡ 0.30 NTU	< 1 #/L‡ 0.125 NTU	>99.99% 97.30%	>99.99% 98.80%
Lindane	0.0002 mg/L	0.0019 mg/L	0.002 ± 10%	< 0.00016 mg/L	0.000035 mg/L	91.80%	97.90%
Tetrachloroethylene	0.005 mg/L	0.015 mg/L	0.015 mg/L ± 10%	< 0.0005 mg/L	< 0.0005 mg/L	>96.6%	>96.6%
O-Dichlorobenzene	0.6 mg/L	1.7 mg/L	1.8 mg/L ± 10%	< 0.5 mg/L	< 0.5 mg/L	>99.9%	>99.9%
Ethylbenzene	0.7 mg/L	2.2 mg/L	2.1 mg/L ± 10%	0.0048 mg/L	0.11 mg/L	99.80%	99.90%
Chlorobenzene	0.1 mg/L	2.0 mg/L	2.0 mg/L ± 10%	0.0038 mg/L	0.0008 mg/L	99.80%	99.90%
Endrin	0.002 mg/L	0.007 mg/L	0.006 mg/L ± 10%	0.0004 mg/L	0.0002 mg/L	94.30%	96.80%

Test Parameters: pH = 7.5 ± 0.5 unless otherwise noted. Flow = 0.55 gpm (2.08 Lpm). Pressure = 60 psig (413.7 kPa). Temp. = 68°F ± 5°F (20°C ± 3°C).

- It is essential that operational, maintenance, and filter replacement requirements be carried out for the product to perform as advertised.
- The disposable water filter should be replaced at least every 6 months.
- The filter monitor system measures the amount of water that passes through the filter and alerts you to replace the filter. When 90% of the filter's rated life is used, the yellow (Order) light comes on. When 100% of the filter's rated life is used, the red (Replace) light comes on, and it is recommended that you replace the filter. For models without filter status lights, replace the filter every 6 months. Use replacement filter model UKF8001. 2014 suggested retail price of \$44.99 U.S.A./\$49.95 Canada. Prices are subject to change without notice.
- The product is for cold water use only.
- Do not use with water that is microbiologically unsafe or of unknown quality without adequate disinfection before or after the system. Systems certified for cyst reduction may be used on disinfected waters that may contain filterable cysts.
- Refer to the "Water Filtration System" section for the Manufacturer's name and telephone number.
- Refer to the "Warranty" section for the Manufacturer's limited warranty.

Water Supply	City or Well
Water Pressure	35 - 120 psi (241 - 827 kPa)
Water Temperature	33° - 100°F (1° - 38°C)
Service Flow Rate	0.55 gpm (2.08 L/min.) @ 60 psi*

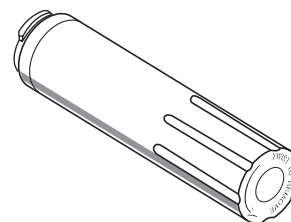

*Class I particle size: >0.5 to <1 µm

**Test requirement is at least 100,000 particles/mL of AC Fine Test Dust

† These contaminants are not necessarily in your water supply. Performance may vary based on local water ††† conditions.

†† Fibers greater than 10 µm in length

‡ Based on the use of *Cryptosporidium parvum* oocysts

® NSF is a registered trademark of NSF International.

MAYTAG® REFRIGERATION LIMITED WARRANTY

ATTACH YOUR RECEIPT HERE. PROOF OF PURCHASE IS REQUIRED TO OBTAIN WARRANTY SERVICE.

Please have the following information available when you call the Customer eXperience Center:

- Name, address and telephone number
- Model number and serial number
- A clear, detailed description of the problem
- Proof of purchase including dealer or retailer name and address

IF YOU NEED SERVICE:

1. Before contacting us to arrange service, please determine whether your product requires repair. Some questions can be addressed without service. Please take a few minutes to review the Troubleshooting or Problem Solver section of the Use and Care Guide, or visit https://www.maytag.com/product_help.
2. All warranty service is provided exclusively by our authorized Maytag Service Providers. In the U.S. and Canada, direct all requests for warranty service to:

Maytag Customer eXperience Center

In the U.S.A., call 1-800-688-9900. In Canada, call 1-800-807-6777.

If outside the 50 United States or Canada, contact your authorized Maytag dealer to determine whether another warranty applies.

TEN YEAR LIMITED WARRANTY

WHAT IS COVERED

WHAT IS NOT COVERED

FIRST YEAR LIMITED WARRANTY (PARTS AND LABOR)

For one year from the date of purchase, when this major appliance is installed, operated and maintained according to instructions attached to or furnished with the product, Maytag brand of Whirlpool Corporation or Whirlpool Canada, LP (hereafter "Maytag") will pay for factory specified replacement parts and repair labor to correct defects in materials or workmanship that existed when this major appliance was purchased, or at its sole discretion replace the product. In the event of product replacement, your appliance will be warranted for the remaining term of the original unit's warranty period.

SECOND THROUGH TENTH YEAR LIMITED WARRANTY (COMPRESSOR ONLY - LABOR NOT INCLUDED)

In the second through tenth years from the date of original purchase, when this major appliance is installed, operated and maintained according to instructions attached to or furnished with the product, Maytag will pay for a factory specified replacement compressor to correct non-cosmetic effects in materials or workmanship in this part that prevent function of the refrigerator and that existed when this major appliance was purchased. This limited 10-year warranty is for the compressor only and does not include labor. YOUR SOLE AND EXCLUSIVE REMEDY UNDER THIS LIMITED WARRANTY SHALL BE PRODUCT REPAIR AS PROVIDED HEREIN. Service must be provided by a Maytag designated service company. This limited warranty is valid only in the United States or Canada and applies only when the major appliance is used in the country in which it was purchased. This limited warranty is effective from the date of original consumer purchase. Proof of original purchase date is required to obtain service under this limited warranty.

1. Commercial, non-residential or multiple-family use, or use inconsistent with published user, operator or installation instructions.
2. In-home Instruction on how to use your product
3. Service to correct improper product maintenance or installation, installation not in accordance with electrical or plumbing codes or correction of household electrical or plumbing (i.e. house wiring, fuses or water inlet hoses).
4. Consumable parts (i.e. light bulbs, batteries, air or water filters, preservation solutions, etc.).
5. Damage from accident, misuse, abuse, fire, floods, acts of God or use with products not approved by Maytag.
6. Repairs to parts or systems to correct product damage or defects caused by unauthorized service, alteration or modification of the appliance.
7. Cosmetic damage including scratches, dents, chips, and other damage to appliance finishes unless such damage results from defects in materials and workmanship and is reported to Maytag within 30 days.
8. Discoloration, rust or oxidation of surfaces resulting from caustic or corrosive environments including but not limited to high salt concentrations, high moisture or humidity or exposure to chemicals.
9. Food or medicine loss due to product failure.
10. Pick-up or delivery. This product is intended for in-home repair.
11. Travel or transportation expenses for service in remote locations where an authorized Maytag servicer is not available.
12. Removal or reinstallation of inaccessible appliances or built-in fixtures (i.e. trim, decorative panels, flooring, cabinetry, islands, countertops, drywall, etc.) that interfere with servicing, removal or replacement of the product.
13. Service or parts for appliances with original model/serial numbers removed, altered or not easily determined.

The cost of repair or replacement under these excluded circumstances shall be borne by the customer.

DISCLAIMER OF IMPLIED WARRANTIES

IMPLIED WARRANTIES, INCLUDING ANY IMPLIED WARRANTY OF MERCHANTABILITY OR IMPLIED WARRANTY OF FITNESS FOR A PARTICULAR PURPOSE, ARE LIMITED TO TEN YEAR OR THE SHORTEST PERIOD ALLOWED BY LAW. Some states and provinces do not allow limitations on the duration of implied warranties of merchantability or fitness, so this limitation may not apply to you. This warranty gives you specific legal rights, and you also may have other rights that vary from state to state or province to province.

DISCLAIMER OF REPRESENTATIONS OUTSIDE OF WARRANTY

Maytag makes no representations about the quality, durability, or need for service or repair of this major appliance other than the representations contained in this warranty. If you want a longer or more comprehensive warranty than the limited warranty that comes with this major appliance, you should ask Maytag or your retailer about buying an extended warranty.

LIMITATION OF REMEDIES; EXCLUSION OF INCIDENTAL AND CONSEQUENTIAL DAMAGES

YOUR SOLE AND EXCLUSIVE REMEDY UNDER THIS LIMITED WARRANTY SHALL BE PRODUCT REPAIR AS PROVIDED HEREIN. MAYTAG SHALL NOT BE LIABLE FOR INCIDENTAL OR CONSEQUENTIAL DAMAGES. Some states and provinces do not allow the exclusion or limitation of incidental or consequential damages, so these limitations and exclusions may not apply to you. This warranty gives you specific legal rights, and you also may have other rights that vary from state to state or province to province.

2/14

CLAUSE D'EXONÉRATION DE RESPONSABILITÉ AU TITRE DES GARANTIES IMPLICITES

LES GARANTIES IMPLICITES, Y COMPRIS LES GARANTIES APPLICABLES DE QUALITÉ MARCHANDE OU D'APTITUDE À UN USAGE PARTICULIER, SONT LIMITÉES À UN AN OU À LA PLUS COURTE PÉRIODE AUTORISÉE PAR LA LOI. Certains États et provinces ne permettent pas de limitation sur la durée des garanties implicites de qualité marchande ou d'aptitude à un usage particulier, de sorte que la limitation ci-dessus peut ne pas être applicable dans votre cas. Cette garantie vous confère des droits juridiques spécifiques et vous pouvez également jouir d'autres droits qui peuvent varier d'une juridiction à l'autre.

EXONÉRATION DE RESPONSABILITÉ DANS LES DOMAINES NON COUVERTS PAR LA GARANTIE

Maytag décline toute responsabilité au titre de la qualité, de la durabilité ou en cas de dépannage ou de réparation nécessaire sur ce gros appareil ménager autre que les responsabilités énoncées dans la présente garantie. Si vous souhaitez une garantie plus étendue ou plus complète que la garantie limitée fournie avec ce gros appareil ménager, adressez-vous à Maytag ou à votre détaillant pour obtenir les modalités d'achat d'une garantie étendue.

LIMITATION DES RECOURS; EXCLUSION DES DOMMAGES FORTUITS OU INDIRECTS

LE SEUL ET EXCLUSIF RECOURS DU CLIENT DANS LE CADRE DE LA PRÉSENTE GARANTIE LIMITÉE CONSISTE EN LA RÉPARATION PRÉVUE PAR LA PRÉSENTE. MAYTAG N'ASSUME AUCUNE RESPONSABILITÉ POUR LES DOMMAGES FORTUITS OU INDIRECTS. Certains États et certaines provinces ne permettent pas l'exclusion ou la limitation des dommages fortuits ou indirects de sorte que ces limitations et exclusions peuvent ne pas être applicables dans votre cas. Cette garantie vous confère des droits juridiques spécifiques et vous pouvez également jouir d'autres droits qui peuvent varier d'une juridiction à l'autre.

11/14