

Keystone®

OWNER'S MANUAL & INSTALLATION MANUAL

ROOM AIR CONDITIONER



MODELS KYST051AD

0011538684

CONTENTS

Safety Information.....	4
-------------------------	---

Using the Air Conditioner

Temperature Control	6
Air Direction	6

Maintenance

Grille and Case	7
Air Filter	7
Outdoor Coils	7

Installation Instructions

Before You Begin	8
Electrical Requirements	8
Parts Included	10
Window Requirements	11
Preparing the Air Conditioner	11
Installing the Air Conditioner	12

Troubleshooting Tips

Normal Operating Sounds	15
-------------------------------	----



Keystone®

Product Warranty Card

Tarjeta de Garantia de Producto

Air conditioner warranty

Your product is protected by this warranty:

Your appliance is warranted by Haier. Any obligations for services and parts under this warranty must be performed by Haier Consumer Services or an authorized Haier servicer.

To contact a Customer Service Representative.

1-800-849-1112®

Garantía

Su producto está protegido por esta garantía:

Su producto está garantizado por Haier. Cualquier obligación de proporcionar servicio o repuestos establecida en esta garantía deberá ser cumplida por los Servicios al consumidor de Haier o por un representante autorizado de Haier.

Para comunicarse con un Representante de Servicio al Cliente.

1-800-849-1112®



Tarjeta de Registracion de Producto

Es sencillo! Cumple y envia su Tarjeta de Registracion de Producto hoy!

Nombre

Dirección

Ciudad Estado Código postal

Teléfono (Opcional) / -

Dirección de E-mail (Opcional)

Donde Comprado

Numero de Modelo

Numero de Serie

Mes

Dia

Año

REV 11/04

Fecha de la compra

Mantenga esta información para sus registros!



Product Registration Card

It's simple! Complete and mail your Product Registration Card today!

Name

Address

City State Zip

Phone (Optional) / -

E-mail Address (Optional)

Where Purchased

Model Number

Serial Number

Month

Day

Year

REV 11/04

Date of Purchase

Keep this information for your records!

SAFETY INFORMATION

IMPORTANT SAFETY INFORMATION

READ ALL INSTRUCTIONS BEFORE USING THE APPLIANCE

WARNING

For your safety, the information in this manual must be followed to minimize the risk of fire, electric shock or personal injury.

- Use this appliance only for its intended purpose as described in this Owner's Manual.
- This air conditioner must be properly installed in accordance with the Installation Instructions before it is used
- Never unplug your air conditioner by pulling on the power cord. Always grip plug firmly and pull straight out from the receptacle.
- Replace immediately all electric service cords that have become frayed or otherwise damaged. A damaged power supply cord must be replaced with a new power supply cord obtained from the manufacturer and not repaired. Do not use a cord that shows cracks or abrasion damage along its length or at either the plug or connector end.
- Turn the unit OFF and unplug your air conditioner before cleaning.
- For your safety, do not store or use combustible materials, gasoline or other flammable vapors or liquids in the vicinity of this or any other appliance.
- If the receptacle does not match the plug, the receptacle must be changed out by a qualified electrician.

WARNING

Risk of Fire or Explosion. This unit contains flammable refrigerant. Additional safety precautions must be followed.

- Do not use means to accelerate the defrosting process or to clean, other than those recommended by the manufacturer.
- The appliance should NOT be stored in a room with continuously operating ignition sources (for example: open flames, an operating gas appliance or an operating electric heater).
- Do not pierce or burn refrigerant tubing. Be aware that refrigerants may not contain an odor.
- Keep ventilation openings clear of obstruction.
- When handling, installing, and operating the appliance, care should be taken to avoid damage to the refrigerant tubing.
- Do not drill holes in the unit.
- Maintenance, cleaning, and service should only be performed by technicians properly trained and qualified in the use of flammable refrigerants.
- We do not support any servicing of the air conditioner.
- Dispose of the air conditioner in accordance with Federal and Local Regulations. Flammable refrigerants require special disposal procedures. Contact your local authorities for the environmentally safe disposal of your air conditioner.

READ AND SAVE THESE INSTRUCTIONS

IMPORTANT SAFETY INFORMATION READ ALL INSTRUCTIONS BEFORE USING THE APPLIANCE

WARNING

USE OF EXTENSION CORDS
RISK OF FIRE. Could cause serious injury or death.

- DO NOT use an extension cord with this Window Air Conditioner.
- DO NOT use surge protectors or multi-outlet adaptors with this Window Air Conditioner.

HOW TO POWER

Do not, under any circumstances, cut or remove the third (ground) prong from the power cord. For personal safety, this appliance must be properly grounded.

DO NOT use an adapter plug with this appliance.

The power cord of this appliance is equipped with a 3-prong (grounding) plug which mates with a standard 3-prong (grounding) wall outlet to minimize the possibility of electric shock hazard from this appliance.

Power cord includes a current interrupter device. A test and reset button is provided on the plug case. The device should be tested on a periodic basis by first pressing the **TEST** button and then the **RESET** button while plugged into the outlet. If the **TEST** button does not trip or if the **RESET** button will not stay engaged, discontinue use of the air conditioner and contact a qualified service technician.

Have the wall outlet and circuit checked by a qualified electrician to make sure the outlet is properly grounded.

Where a 2-prong wall outlet is encountered, it is your personal responsibility and obligation to have it replaced with a properly grounded 3-prong wall outlet.

The air conditioner should always be plugged into its own individual electrical outlet which has a voltage rating that matches the rating plate.

This provides the best performance and prevents overloading house wiring circuits which could cause a fire hazard from overheated wires.

See the Installation Instructions, **Electrical Requirements** section for **specific electrical connection requirements**.

READ AND SAVE THESE INSTRUCTIONS

USING THE AIR CONDITIONER

Controls

(Features and appearance may vary)

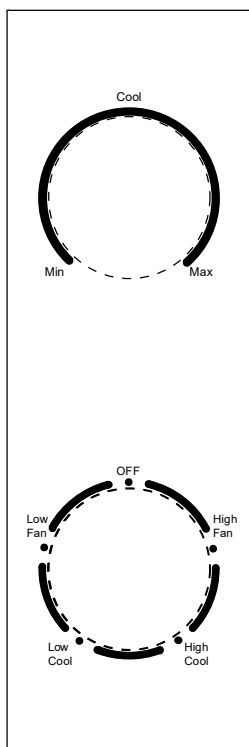

Air Conditioner Controls

Controls

- 1. Temperature Controls**
This determines how much cooling is provided.
Max Cool - **Max** provides the most cooling
Min Cool - **Min** provides the least.
- 2. Mode Control**
High Cool and **Low Cool** provide cooling with different fan setting speeds.
High Fan and **Low Fan** provide circulation and filtering without cooling.

Note

If you move the Temperature knob from cool to **FAN MODE** or power off the unit while cooling, wait at least 3 minutes before switching back to **COOL MODE**.

Air Direction

Use the lever to adjust the air direction left to right.

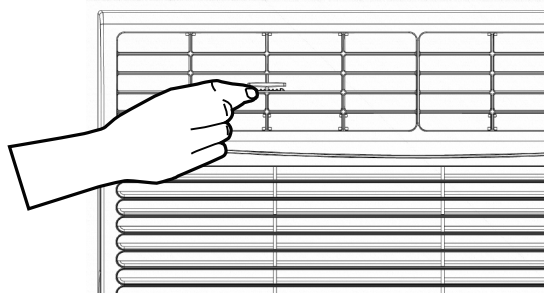

CARE AND CLEANING

Maintenance

Do Not Operate in Freezing Outdoor Conditions

This cool-only air conditioner was not designed for freezing outdoor conditions. Operating temp range: $32^{\circ}\text{F} < \text{Outdoor temp} < 110^{\circ}\text{F}$. It must not be used when the outdoor temperature is below freezing (32°F).

Grille and Case

Turn the air conditioner off and remove the plug from the wall outlet before cleaning. Clean filter by using warm water and a mild detergent. Do not use bleach or abrasives.

Air Filter

The air filter should be checked and cleaned at least every 30 days or more often if necessary.

To Remove

- Slide the filter from the left side of the unit. Remove the filter.
- Clean the filter with warm, soapy water. Rinse and let the filter dry before replacing it. Do not place filter in a dishwasher.

CAUTION

DO NOT operate the air conditioner without a filter as this will cause dirt and lint to build up and will reduce the performance of the unit.

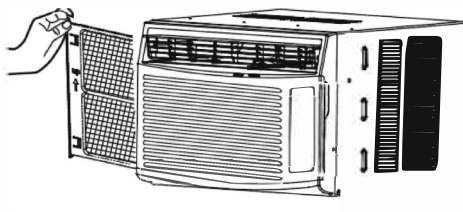

Outdoor Coils

The coils on the outdoor side of the air conditioner should be checked regularly. If they are clogged with dirt or soot, they may need to be professionally cleaned.

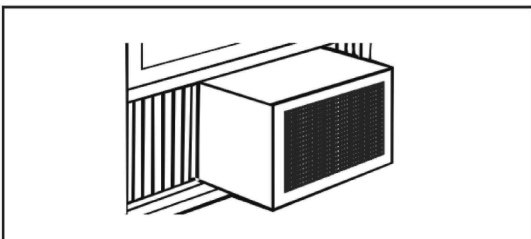

INSTALLATION INSTRUCTIONS

BEFORE YOU BEGIN

Read these instructions completely and carefully.

- **IMPORTANT** – Save these instructions for local inspector's use.
- **IMPORTANT** – Observe all governing codes and ordinances.
- **Note to Installer** – Be sure to leave these instructions with the Consumer.
- **Note to Consumer** – Keep these instructions for future reference.
- **Skill Level** – Installation of this appliance requires basic mechanical skills.
- **Completion Time** – Approximately 1 hour.
- We recommend that two people install this product.
- Proper installation is the responsibility of the installer.
- Product failure due to improper installation is not covered under the Warranty.
- You **MUST** use all supplied parts and use proper installation procedures as described in these instructions when installing this air conditioner.

ELECTRICAL REQUIREMENTS



This model requires:

- 115/120-volt AC, 60-Hz grounded outlet protected with a 15-amp time-delay fuse or circuit breaker.
- The 3-prong grounding plug minimizes the possibility of electric shock hazard. If the wall outlet you plan to use is only a 2-prong outlet, it is your responsibility to have it replaced with a properly grounded 3-prong wall outlet.

CAUTION

- Do not, under any circumstances, cut or remove the third (ground) prong from the power cord.
- Do not change the plug on the power cord of this air conditioner.
- Aluminum house wiring may create issues - consult a qualified electrician.

The power cord includes a current interrupter device. A test and reset button are provided on the plug case. The device should be tested on a periodic basis by first pressing the **TEST** button and then the **RESET** button while plugged into the outlet. If the **TEST** button does not trip or if the **RESET** button will not stay engaged, discontinue use of the air conditioner and contact a qualified service technician.

TOOLS REQUIRED

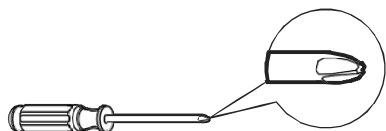

Phillips Head Screwdriver

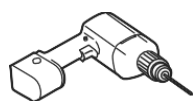

Drill and 1/8" Drill Bit



Pencil

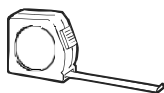

Ruler or Tape Measure



Level



Scissors or Knife

PARTS INCLUDED

(Appearance may vary)

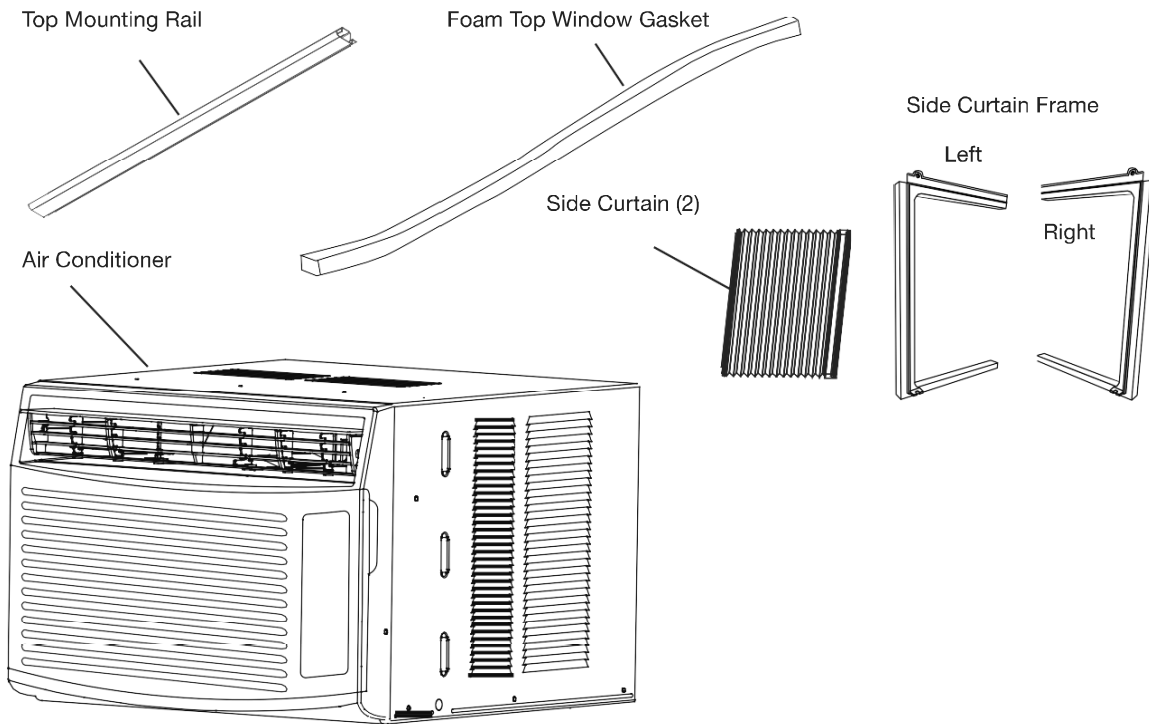

Type A (3)

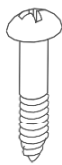

Type B (9)

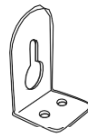

Side Brackets (2)



Window Locking Bracket (1)

1. WINDOW REQUIREMENTS

- These instructions are for a standard double-hung window. You will need to modify them for other types of windows.
- The air conditioner can be installed without the side curtain panels if needed to fit in a narrow window. See the window opening dimensions.
- All supporting parts must be secured to firm wood, masonry or metal.
- The electrical outlet must be within reach of the power cord.
- Follow the dimensions in the table and illustration for your model.

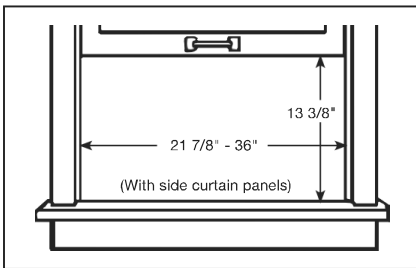

2. STORM WINDOW REQUIREMENTS

- A storm window frame will not allow the air conditioner to tilt toward the outside and will keep it from draining properly. To adjust for this, attach a piece of wood to the sill.
- **WOOD PIECES WIDTH: 2"**
- **LENGTH:** Long enough to fit inside the window frame.
- **THICKNESS:** To determine the thickness, place a piece of wood on the sill to make it 1/2" higher than the top of the storm window frame or the vinyl frame.
- Attach securely with nails or screws provided by the installer.

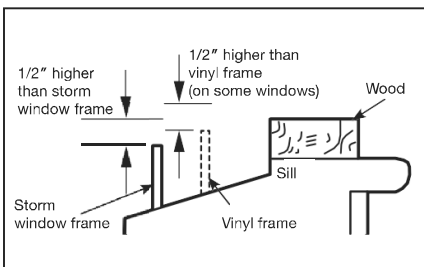

3. PREPARE THE AIR CONDITIONER

- A. Screw the top mounting rail onto the top of the AC with 3 Type A screws.

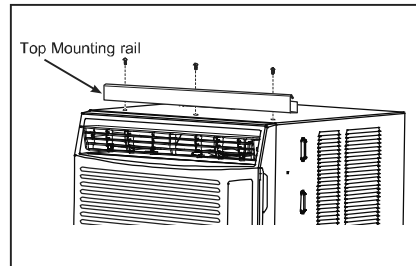

- B. Slide the curtain panels into the side panel rails.

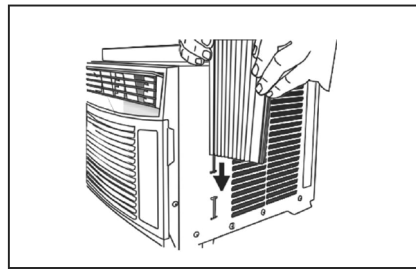

- C. Assure that the side curtains snap into side of the frames.

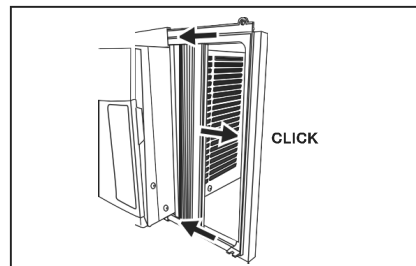

4. INSTALL THE AIR CONDITIONER IN THE WINDOW

A. Measure the width of the window opening and mark the center line on the inside windowsill. Place the unit in the window. Lower the window to hold unit in place.

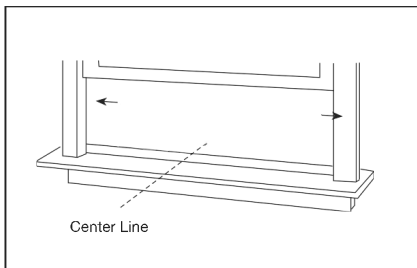

B. Set the air conditioner in the window so that it is centered. Place the air conditioner so that front edge of the bottom mounting rail is against the back edge of the sill.

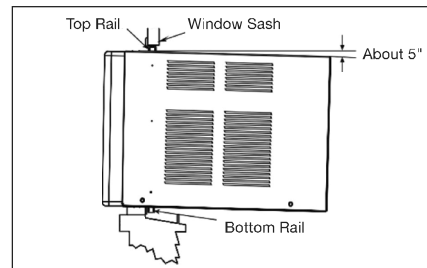

C. Install the side bracket into the unit and into the windowsill using two 1" wood screws provided. repeat on other side.

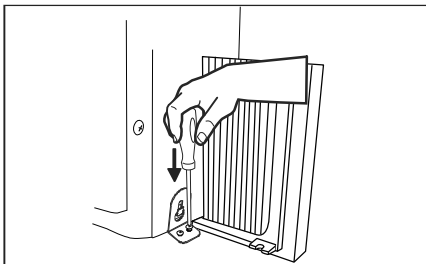

D. Bring the window down so that the front edge of the top mounting is in front of the window. Make sure that the air conditioner is level or tilting slightly to the outside.

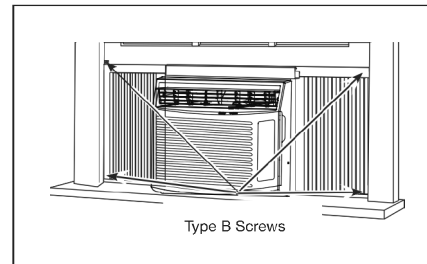

E. Extend the curtain panels until they fill the window. Mark the location of the holes in each corner. Use the drill and 1/8" drill bit to drill pilot holes. Use 4 Type B screws to secure the side panels in place.

5. INSTALL WINDOW LOCKING BRACKET AND FOAM TOP WINDOW GASKET

CAUTION

A. To prevent broken glass or damage to windows, on vinyl or other similarly constructed windows, attach the window locking bracket to the window side jamb with one Type B screw.

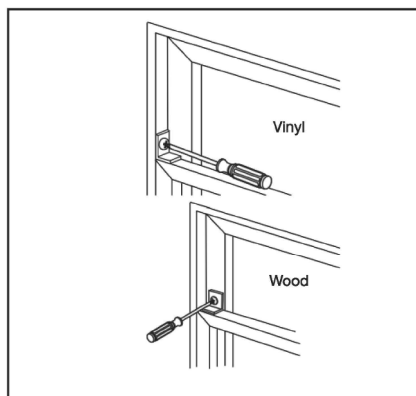

B. Cut the foam top window gasket to the window width.

C. Stuff the foam between the glass and the window to prevent air and insects from getting into the room.

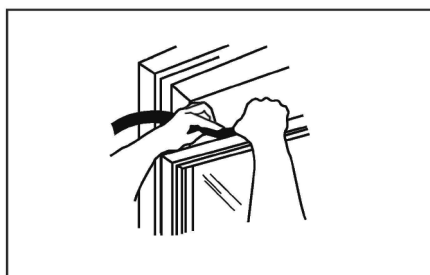

Note

If the gasket supplied does not fit your window, obtain the appropriate material locally to provide a proper installation seal.

TROUBLESHOOTING TIPS

Review the chart on the following page for Troubleshooting Tips.
If issue persists, please call for further assistance.

Issue	Possible Cause	What To Do
Air conditioner does not start	The unit is unplugged	Make sure the air conditioner plug is pushed completely into the outlet.
	The fuse is blown/circuit breaker is tripped	Check the house fuse/circuit breaker box and replace the fuse or reset the breaker.
	Power failure	The unit will automatically restart in the setting last used after the power is restored. There is a protective time delay (approximately 3 minutes) to prevent tripping of the compressor overload. For this reason, the unit may not start normal cooling for 3 minutes after it is turned back on.
	The current interrupter device is tripped	Press RESET button located on the power cord plug. If the RESET button will not stay engaged, discontinue use of the air conditioner and contact a qualified service technician.
Air conditioner does not cool as it should	Indoor airflow is restricted	Make sure there are not curtains, blinds or furniture blocking the front of the air conditioner.
	The temp control may not be set properly	Turn the temperature control to a higher number.
	The air filter is dirty	Clean the filter at least every 30 days. See Care and Cleaning section.
	The room may have been hot	When the air conditioner is first turned on, you need to allow time for the room to cool down.
	Cold air is escaping	Check for open furnace registers and cold air returns.
	Cooling coils have iced up	See "Air conditioner freezing up" below.
Air conditioner freezing up	Ice blocks the air flow and stops the air conditioner from cooling the room	On models with control knobs, set the mode control at High Fan or High Cool with the Temp at 1 or 2. May have lost refrigerant.
Water drips outside	Hot, humid weather	This is normal.
Water drips inside	The air conditioner is not tilted to the outside	For proper disposal, make sure the air conditioner slants slightly from the case front to the rear.
Water collects in base pan	Moisture removed from air and drain into base pan	This is normal for a short period in areas with little humidity; normal for a longer period in very humid areas.

Normal Operating Sounds

- You may hear a pinging noise caused by water being picked up and thrown against the condenser on rainy days or when the humidity is high. This is normal, unit is equipped with a slinger blade which scoops up the water from the drain pan and throws it onto the coils for better efficiency.
- You may hear the thermostat click when the compressor cycles on and off.
- Water will collect in the base pan during high humidity or on rainy days. The water may overflow and drip from the outdoor side of the unit. The drain plug may be removed for quicker drainage.
- The fan may run even when the compressor does not.

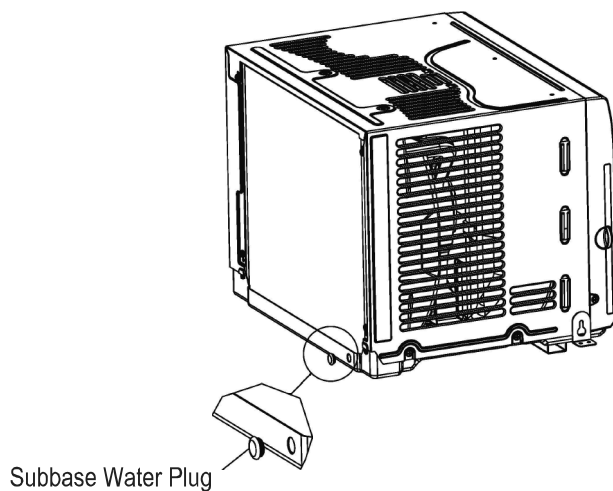

- Drain plug may be removed for gravity drain but may reduce efficiency.
- **DO NOT** drill any holes.

NOTES

NOTES

Keystone®

1-800-849-1112 | www.keystone-products.com

Printed in Thailand

