



EN

LIVE WITH  
**ILVE**

KITCHEN APPLIANCES  
HANDMADE IN ITALY



**PRO-LINE**  
**GAS COOKTOP & ELECTRIC OVEN**  
**FREESTANDING COOKERS OPERATING**  
**& INSTALLATION MANUAL**

cod. EI33960020000EN  
18/2018





KITCHEN APPLIANCES  
HANDMADE IN ITALY

Congratulations, you are now the proud owner of an ILVE cooking appliance. Thank you for purchasing ILVE and welcome to the exciting world of cooking the ILVE way.

This instruction manual has been specially created to inform you of the full range of features your ILVE appliance has to offer and serves as an introduction to the wonderful benefits of ILVE's dynamic cooking systems.

We present detailed information on each of the advanced cooking systems built into ILVE appliances. Once you have read this section you will be able to choose the most appropriate settings for your appliance when cooking different types of food.

We ask you to read the instructions in this booklet very carefully as this will allow you to get the best results from using your appliance.

**KEEP THE DOCUMENTATION OF THIS PRODUCT FOR FUTURE REFERENCE.**

# YOUR FREE MASTERCLASS

Although we encourage you to dive right in, as the owner of a brand new ILVE oven we'd also like to invite you to attend a complimentary 2 hour masterclass. As part of the class you'll learn how to prepare and cook a number of delicious signature ILVE dishes, not to mention our top tips for getting the most out of your ILVE oven. From improving cooking results to general maintenance information, we know you'll enjoy this comprehensive, fun masterclass.

Simply go to [ilve.com.au/bookings](https://ilve.com.au/bookings) or Phone 1300 MY ILVE (694 583)



LIVE WITH  
**ILVE**

KITCHEN APPLIANCES  
HANDMADE IN ITALY



# OPEN 24/7

ILVE ACCESSORIES ONLINE SHOP

For a wide range of Genuine ILVE accessories at the  
click of a button [shop.ilve.com.au](http://shop.ilve.com.au)

# iWarranty

**REGISTER YOUR WARRANTY ONLINE NOW**

GO TO: <https://support.eurolinx.com.au/#/form/warrantyregistration>

As a part of our continued customer service offering, you can now register your ILVE products online at <https://support.eurolinx.com.au/#/form/warrantyregistration>

Just follow our simple online registration process.

Please ensure that you always keep your proof of purchase in order for your warranty to remain valid should you ever need to use it.

As always, you can contact us on  
1300 856 411

# CONTENTS

## USER GUIDE

---

### 4 IMPORTANT SAFETY WARNINGS

14 First operation of the oven

---

### 15 INSTRUCTIONS FOR USE

15 Using the hob

17 Use of a steak grill

18 Proper use of burners

19 Use of the gas fry-top

20 Electric Multifunction Oven

22 Optional

---

### 23 CLEANING AND MAINTENANCE

24 Bulb replacement

24 Removing the door

25 Door cleaning and Glasses

26 Tips for cleaning the hob

27 Tips for cleaning the oven and front panel

28 Recommendations for cleaning the cooktop

---

### 28 PROBLEM SOLVING

29 General problems

---

### 30 COOKING CHART

30 Ventilated convection oven

32 Static oven

## INSTALLATION

---

### 32 INFORMATION - To be reminded to the user

---

### 33 INSTALLATION

33 Installation of the cooker

33 Room ventilation

34 Positioning of the appliance between furniture

35 How to install the fixing bracket

---

### 36 ELECTRICAL CONNECTIONS

36 Groups of cooking

### 37 GAS CONNECTIONS

37 By the Qualified installer

---

### 38 ADJUSTMENT

38 Replacement of the injectors for models

39 Kitchen table PRO LINE

40 Adjustments minimum GAS flow

---

### 41 WIRING DIAGRAM

42 Key

---

### 43 NOTES

# IMPORTANT SAFETY WARNINGS



---

## Appliance data

As well as being shown on the packaging, the data plate is applied to the oven door frame and is visible with the door open.

---

## CAUTION

These warnings refer to different types of appliances. Pay attention in properly identifying the type you own (see the data plate).

These warnings are valid for the countries mentioned in the plate.

- 
- 1** Before using the cooker, read the instructions booklet carefully. This contains very important information concerning safety during installation, use and maintenance. The instructions booklet must be kept with care for later consultation.

---

  - 2** The electrical safety of this cooker is guaranteed only if it is correctly grounded as required by the regulations. It is fundamental to ensure that these regulations have been respected; if you are in doubt, contact a skilled technician to have the electric system accurately checked. The manufacturer is not responsible for damage caused by a bad grounding system.

---

  - 3** **Before powering the appliance, check that the technical features shown on the data plate match those of the electrical system perfectly. Installation / regulation must be carried out by qualified personnel.**

---

  - 4** **Make sure that air around the appliance can circulate freely. This appliance is not connected to an evacuation device for the combustion products, therefore the ventilation of the room must be analysed carefully and according to the rules in force.**

# IMPORTANT SAFETY WARNINGS



---

**CAUTION**  
**continued...**

- 5** When using a gas appliance, heat and dampness are generated inside the premise. A good aeration of the kitchen must be guaranteed by keeping the natural aeration vents open or by installing a mechanical aeration device (hood). An intensive and prolonged utilization of the appliance may result in the need of supplementary aeration, such as opening a window or increasing the power of the hood (if present).

---

- 6** The alimentation cable is supplied without a plug. To connect it please refer to the paragraph “electric connection”. It is recommended to not use adapters, multiple-outlet plugs or extensions.
- 7** When the appliance is not in use for a prolonged time, disconnect the electric power, switch off the main switch and turn off the gas.

---

- 8** Do not block ventilation or heat dissipation slits.

---

- 9** If the alimentation cable is damaged it must be replaced exclusively by a service center approved by the manufacturer.

---

- 10** The appliance must be used only for the purposes for which it was intended. Any other use (for example, heating a room) is incorrect and therefore dangerous. The manufacturer declines all responsibilities for damage caused by similar incorrect uses.

---

- 11** The appliance is not destined to be activated by means of an external timer or a remote control.

---

# IMPORTANT SAFETY WARNINGS



---

**12 The use of any electrical appliances requires that a number of fundamental rules must be respected:**

---

- A.** Never touch the appliance when you have wet or damp hands or feet;
- B.** Never use the appliance barefoot;
- C.** Avoid using extensions;
- D.** Never pull the electric cable to remove it from the power socket;
- E.** Do not expose the appliance to atmospheric agents (rain, sun, etc...);
- F. Be careful: accessible parts can become very hot during the use.**

Keep children less than 8 years old far from the cooker if it is not continuously watched. This appliance may be used by children of 8 years of age or older, by people with reduced physical, sensory or mental abilities, or with lack of experience and knowledge only if they are under adequate surveillance or if they have been adequately instructed about the use of the cooker and if they are aware of the possible dangers. Children must not play with the cooker. The operations of cleaning and of maintenance must not be made by children without surveillance.

---

**13 CAUTION: During the utilization of the appliance some parts may become very hot. Keep out of reach of children.**

---

**14 Absolutely do not touch the elements inside the oven during the utilization.**

---

# IMPORTANT SAFETY WARNINGS



- 
- 15** Before cleaning the appliance or carrying out maintenance, disconnect the power supply by removing the plug from the socket or switching off the switch.
- 
- 16** In case of breakdown or malfunction switch off the appliance and do not attempt any repairs that must only be performed by an authorized service center. Always request original parts. Failure to comply with these instructions may compromise the appliance's safety.
- 
- 17** Never place unstable or deformed pans on the burners or on the electric hotplates as they could topple accidentally.
- 
- 18** When the appliance is not being used, make sure the knobs are exactly in the “●”/“○”/ position.
- 
- 19** Inflammable liquids, like alcohol or gasoline, must be kept away from the appliance.
- 
- 20** Should you use small household appliances near the cooking top, please make sure that the electrical cable is not in contact with hot parts of the appliance.
- 
- 21** To assure the right function of gas appliance, make sure that the rooms are ventilated. Check that the installation is carried out in accordance with the instructions.
- 
-  **22** The materials used in producing our appliance are compatible with the environment and therefore recyclable. The packaging waste must not be left within reach of children, and must be disposed by using the appropriate recycling channels. To scrap your appliance, use your retailer and/or your local council's facilities; remember to make your appliance unusable before scrapping it.

# IMPORTANT SAFETY WARNINGS



- 
- 23** If the rotation of the gas knobs is difficult, don't do anything. Close off the gas and call the After Sales Service for advice.
- 
- 24** Do not use a steam cleaner to clean the inside parts of the oven.
- 
- 25** Don't use any abrasive detergent or sharp device to clean the oven glass door. This may cause damage or breakage.
- 
- 26** Don't modify the appliance.
- 
- 27** **Be careful:** fat spillage, objects or oils on the appliance may cause a fire.
- 
- 28** The appliance must be used by responsible people
- 
- 29** **Be careful:** the use of inappropriate or unsuitable protections can cause fires and/or damage.
- 
- 30** **Be careful: cooking with fat or oil can be dangerous or cause fires.**
- 
- 31** **Fire danger:** do not store items on the cooking surfaces.
- 
- 32** **Be careful: in the case of fire never attempt to extinguish a flame/ fire with water, but turn the appliance off and cover the flame with a lid or with a fireproof cover.**
- 
- 33** **Be careful: do not use gas burners if the flame is unstable.**
- 
- 34** Ensure that the flame diffusers are properly positioned in their seats with their respective caps.

## IMPORTANT SAFETY WARNINGS



- 
- 35** Do not leave the cooker unguarded during any cooking that can spit fats or oils.
- 
- 36** Do not touch the heating elements while the appliance is on. Let it cool down before cleaning
- 
- 37** Food preparation in plastic or aluminum containers on hot cooking zones is forbidden just like the positioning on the cooking surfaces of plastic or aluminum foil objects.
- 
- 38** Do not cover the burners or the hob with tinfoil.
- 
- 39** Do not use the appliance's surface as a work top, sharp objects might scratch it.
- 
- 40** Be careful: do not use frying pans, saucepans, grills or stones for grilling of a greater size than the maximum ones indicated for each single burner; above all they must not cover more than one burner at the same time.  
The heat accumulation might damage the cooker.
- 
- 41** In case of liquid spilling over, remove it from the hob.
- 
- 42** Do not place empty saucepans on the cooking areas.
- 
- 43** The cooking areas, must not work empty, without saucepans.
- 
- 43** It is important that you place nothing on the base of the oven

# IMPORTANT SAFETY WARNINGS



---

## First system startup of the oven

When using the oven for the first time, let it work empty for about 1 hour (230°C), possibly leaving the kitchen windows open.

When you first turn the oven on, a bad smell is emitted due to production residues such as grease, oils or resins.

When the oven has cooled clean it following the instructions in the «Cleaning and care section».

After the indicated time the oven is ready to perform its first cooking.

# IMPORTANT SAFETY WARNINGS

**BE CAREFUL:**

keep children and disabled people away during the operation. Do not use the appliance as a heating source.

**General notes**

to keep the appliance efficient and safe, maintenance must be entrusted to specialised technicians or to the after-sales service staff. Choose covered pans based on the quantity of food to cook.

**IMPORTANT**



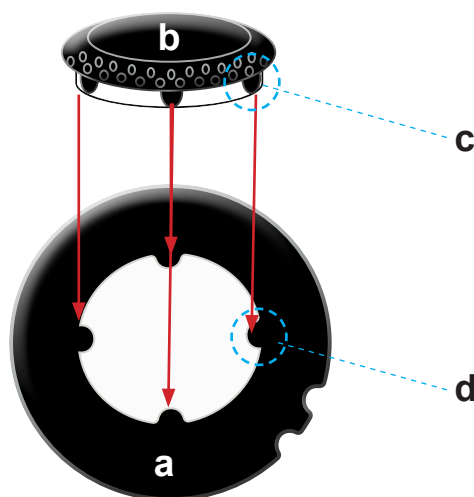

Position the flame divider “b” correctly. To do this, align the 4 teeth “c” of the flame divider with the recess “d” of the aluminium Cup “a”.



**Lighting the burners**

The index above the knobs will help you to find the corresponding burner. Press the knob by turning it anti- clockwise and bring it to the ignition position; keep the knob pressed for about 5 seconds so that upon its release the flame remains alight (in case of unsuccessful ignition repeat the operation).

**Symbol      Function**

-  off
-  maximum
-  minimum
-  index

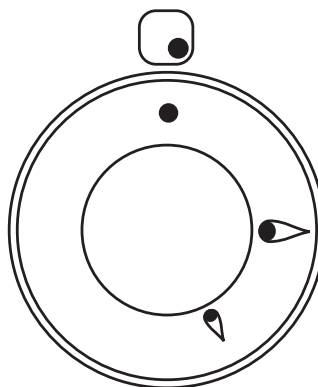

# INSTRUCTIONS FOR USE

## - First system startup of the hob

Recommended pans according to burner size:



Burners	ID	Diameter Ø (cm)
Medium	SR	10 ÷ 20
Large	R	20 ÷ 24
Fish burner	P	oval pans (380 x 185)
Ring	TC/DCC	22 ÷ 28
Dual - Ring	DUAL	24 ÷ 30

### Operating the DUAL WOK

Identify the knob with the help of the index near the knobs. Press and turn the knob to the symbol (maximum) for 5 seconds. Once the burner is on, by turning the knob counterclockwise it gets to its first block that corresponds to the middle one. By applying a bit of force, the first block is exceeded and the outer ring goes out leaving only the little central burner turned on called AUXILIARY. To adjust the auxiliary burner on minimum, rotate the knob counterclockwise until it stops. At this point, to turn the burner back on, rotate the knob clockwise up to the desired value.

### Symbol Function



off



maximum



minimum



index

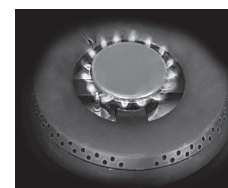
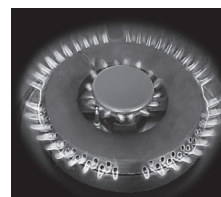
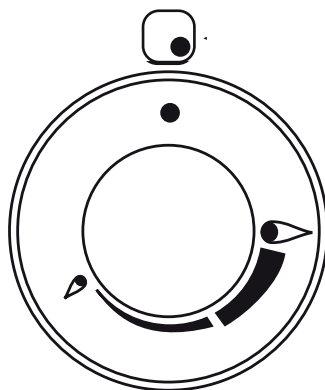

# INSTRUCTIONS FOR USE

## - Use of a grill pan

### Grill pan

If you want to use a grill pan a few things must be taken into account:

- to preheat the grid on the burner's maximum power for no more than 10 minutes;
- we recommend cooking foods with reduced power;
- keep at least a distance of 150mm from the side wall to the gridiron's rim;
- do not position the grill pan on more than one burner at the same time.

### Correct



### Be careful: wrong



### Be careful: wrong

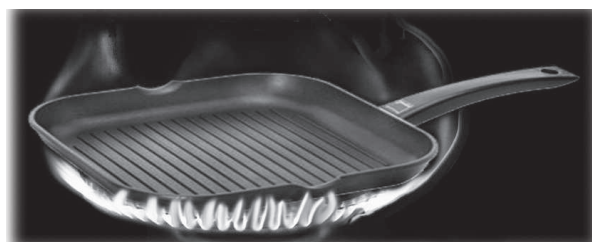

# INSTRUCTIONS FOR USE

## - Positioning placement of the burners

Positioning of the burners



**BE CAREFUL:** always check that the burners are properly positioned), with a uniform flame that is not noisy.

BURNERS	RIGHT	WRONG
Medium		
Large		
Dual Ring		

# INSTRUCTIONS FOR USE

## - Use of the gas fry-top (on applicable models)

### FRY-TOP A GAS

A = cooking area

B = drip tray

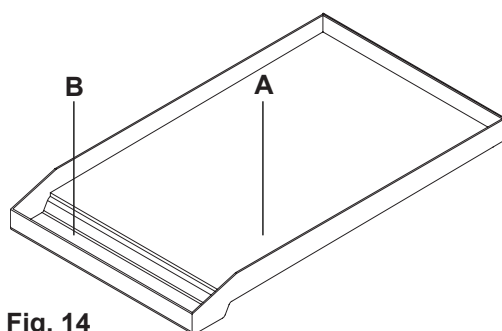



Fig. 14



Fig. 15

### Functioning of the appliance

The fry-top (fig. 14) consists of a stainless-steel plate, suitable for contact with food [  ] with a uniformity of temperature on the cooking surface and with a very low heat loss. To use the appliance, light the flame below the plate by means of the corresponding knob (**see “Lighting the burners”**) and ensure that there is a flame. Turn the knob to maximum for about 10 minutes and wait for the plate to heat up. Once this time has elapsed, the plate is ready to start cooking. By adjusting the flame, there is no limit to your culinary imagination. If you turn the control knob to the low setting, this allows slow or dietetic cooking. Higher temperatures are suitable for cooking meat, fish and vegetables. The Fry-Top plate is ideal for Oriental cooking with an optional accessory (Dome lid) needed for this type of cooking (available for purchase. Some models are supplied with the spatula shown in figure 15, which is useful both for cooking and for cleaning the plate.

### Cleaning and care

It is recommended to clean the plate thoroughly at the end of each cooking session. With the plate hot and the flame at minimum, remove the cooking residue using the scraper provided (fig. 15). Pour a little water onto the plate and, still using the scraper, continue cleaning the plate. Once the water has completely evaporated, repeat the same operation even several times until the desired result is obtained. It is extremely important to clean the plate when it is quite hot. The black enamel flue may be cleaned with a soft cloth soaked with a solution of lukewarm soapy water or a mix of water & white vinegar. Rinse and dry after cleaning.

### Adjuster (Knob)

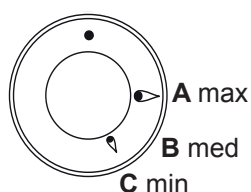

Type of cooking	Knob posit	Time min.
Egg	B	2
Sliced aubergines (0.5 cm thick)	B	9 ÷ 13
Sliced potatoes	B	5 ÷ 73
Sliced courgettes	B	3 ÷ 5
Fish (sea bream weighing about 200 g)	B	15
Hamburger	B	10
Beef steak	B	3
Porterhouse (2 cm thick)	A	5

# INSTRUCTIONS FOR USE

## - Use of the electric oven multifunction

---

### Description

---

S. Selector

---

T. Thermostat

---

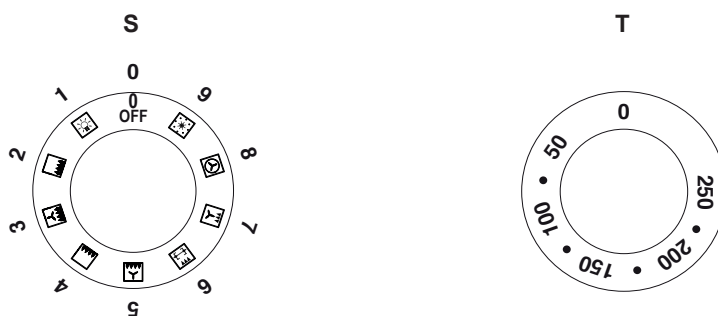

---

### Command of the oven multifunction

---

S. Multifunction electric oven selector

T. Temperatures, from 50°C to 250°C, can be selected by using this knob.

---

---

### Turning on and off

---

Turn the selector to the chosen cooking position and the thermostat to the desired temperature. The warning light turns on and stays on until the oven heats up. As soon as it reaches the selected temperature, the light goes off. It turns on every time the resistances are entered. If you plan to preheat the oven, only place the food to be cooked when this light has gone off. To turn the oven off bring both knobs back to the starting position (0).

---

---

### Safety thermostat

---

The oven is equipped with a safety thermostat, which switches off the electric power. The resetting of the thermostat, according to the decrease in the temperature of the oven, is automatic. The oven can be used again when cooled down. In case the safety thermostat acts because of a defect of the components, you are requested to call the After Sales Service.

---

---

### Function oven

---

Scegliere una delle 9 funzioni di cottura ruotando il selettore (S) e regolare la temperatura (da 50°C a 250°C) con il termostato (T). Se il vostro modello è provvisto di programmatore, predisponetelo per la cottura.

---

---

### Oven light









---

To turn the light off or on gently press the selector knob (S). The light does not work if the selector is set to (0).

---

# INSTRUCTIONS FOR USE

## - Use of the electric oven multifunction - Functions list

Pos.	Symbol	Function
1		<b>Pizza cooking</b> This function is particularly suitable for cooking pizza, focaccia and bread. The main source of heat is from the bottom heating element that works in combination with the oven's other resistances.
2		<b>Normal static cooking</b> It is the oven's classic function particularly suited to cooking the following foods: pork chops, sausages, cod, braised beef, game, roast veal, meringues and biscuits, baked fruit, etc.
3		<b>Cooking from underneath</b> This is the most suitable mode to finish the food cooking, in particular confectionery (biscuits, meringues, leavened cakes, fruit desserts, etc.) and other foods.
4		<b>Cooking from above</b> Especially suitable for browning and to give the final touch of colour to many foods; it is recommended for ham- burgers, pork chops, veal steaks, sole, cuttlefish, etc.
5		<b>Closed door grill cooking</b> The suitable function for fast and deep grilling, to brown and roast meats in general, fillet steaks, Florentine steaks, grilled fish and also grilled vegetables. Cooking with the electric grill must be made with the thermostat at 180 °C.
6		<b>Fan grill cooking</b> Particularly fast and deep with significant energy savings, this function is suitable for many foods such as pork chops, sausages, pork or mixed spits, game, gnocchi alla romana, etc. Cooking with the electric grill must be made with the thermostat at 180 °C.
7		<b>Intensive cooking</b> Is the quick and intense cooking function for various dishes; best for: baked fish, braised vegetables, spits, duck, chicken, etc.
8		<b>Multiple fan cooking</b> It is the function that allows simultaneous cooking of different dishes without the smells blending; you can cook lasagne, pizza, croissants and brioches, tarts, cakes, etc.
9		<b>Defrosting</b> Allows rapid defrosting of all frozen foods bringing them quickly to room temperature. For best results you should always plan a temperature not exceeding 100 °C.

### Quick Start (only available on some models)

This function speeds up your oven's pre-heating. We suggest you use this function when you set a cooking temperature from between 200 and 250 °C. Use of the QuickStart function for temperatures under 200 °C is not advantageous. To use QuickStart, rotate the selector knob (S) until it is positioned on the symbol (9), then set the desired temperature with the thermostat knob (T). Once the oven has reached the temperature, the thermostat's orange light will turn off and the oven is ready for accepting the food to be cooked. At this point set the desired cooking function with selector knob (S).

**WARNING: the Quick Start function is not suitable for cooking foods, it is only for quickly pre-heating the oven. DO NOT USE THE QUICK START FUNCTION FOR MORE THAN TWENTY MINUTES.**

# INSTRUCTIONS FOR USE

## - OPTIONAL

### Telescopic runners (only in certain models)

Telescopic runners increase the ergonomics of operating your oven, they are practical and safe when moving baking trays in and out of the oven. The kit includes completely extendible lateral runners, which slide on ball bearings to facilitate the removal and positioning of the trays. The runners are anti tip-over for better safety. It is possible to remove them to clean them or move them as illustrated in the pictures below. Check availability with Eurolinx Pty Ltd (P: 1300 694 583)

Pull down the part highlighted in red to remove it from the oven.

Turn over the grill and place it on a flat surface with the telescopic runner facing down.

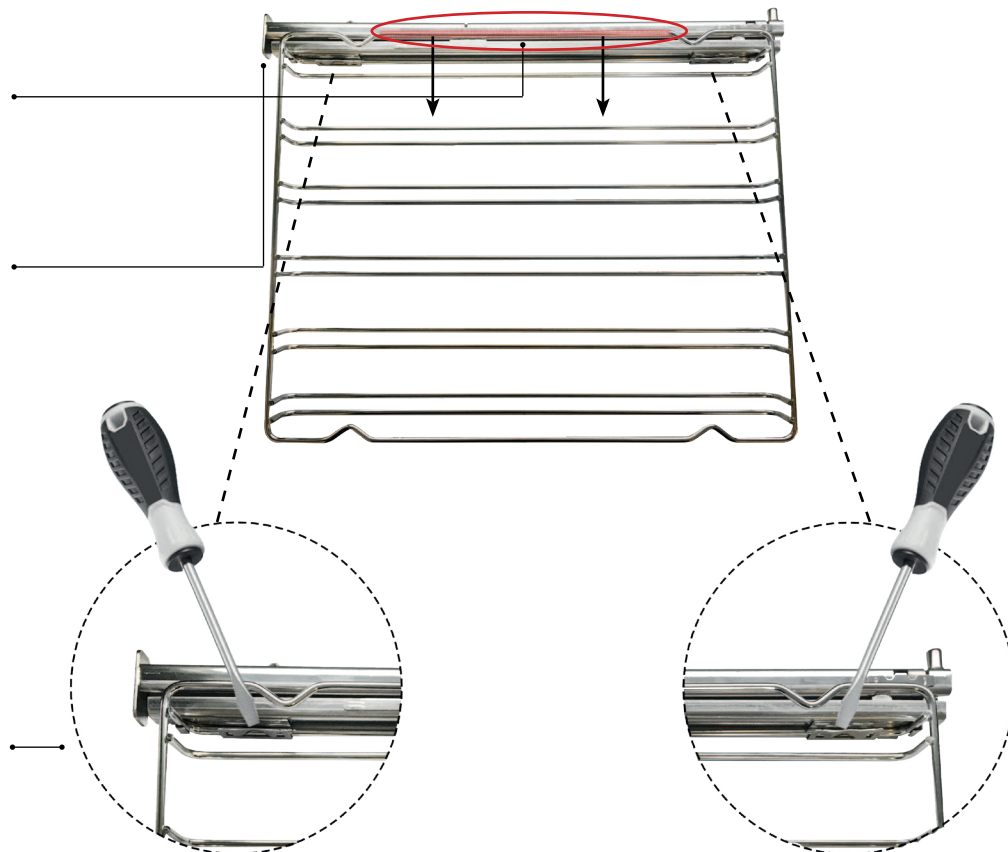

To unlock the clip, loosen with a flathead screwdriver

Repeat the operations backwards to reposition the grills.

# CLEANING AND MAINTENANCE

## - Replacing the bulb

### Procedure to follow

Should the oven light not work, disconnect the appliance from the mains, remove the lamp protection glass and replace the bulb. The new bulb must, naturally, be suitable for use at high temperatures and has the characteristics for such use.

1

Losen whit a flathead screwdriver



2

Remove the glass cover

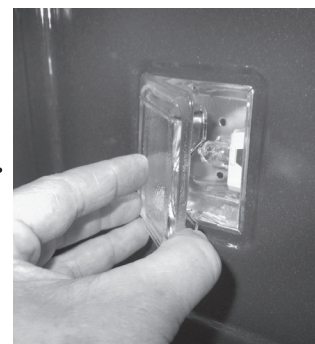

3

Pull out the light

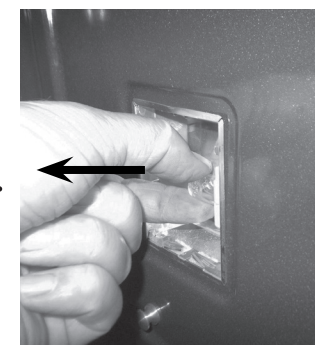

4

Replace and close again

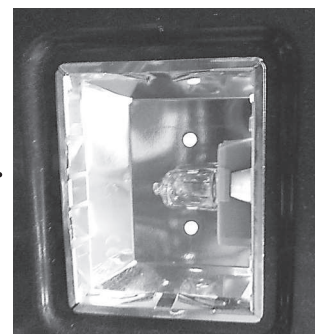

# CLEANING AND MAINTENANCE

## - Door removal

### Procedure to follow

For ease of intensive cleaning it is practical to dismantle the door following these instructions:

- open the door
- move the hook C to the hinge zone d, following the steps

1

Zone C

Zone D

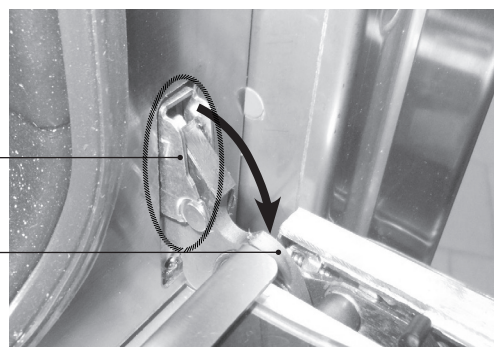

2

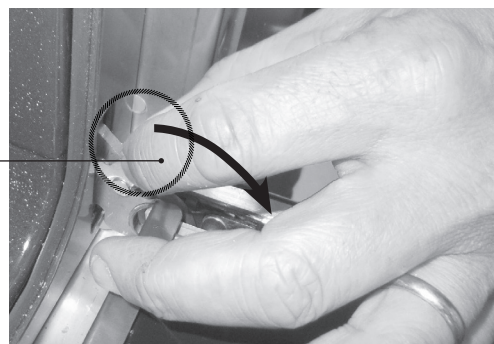

3



4

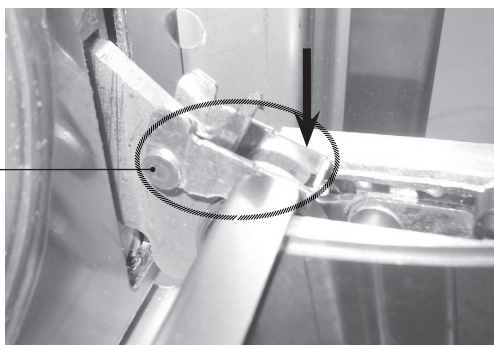

# CLEANING AND MAINTENANCE

## - Cleaning the door and glasses

### Procedure to follow

The oven door is composed of 3 sheets of plate glass. The plate glass parts may be cleaned using absorbent kitchen paper and an ordinary non-abrasive detergent. **Do not** use coarse abrasive cleaning materials or sharp metal scrapers to clean the oven's glass doors since they can scratch the surface and cause the glass to shatter. The middle layer of glass can be removed to facilitate cleaning. To do this it is necessary to dismantle the oven door or, alternatively, to set it in the intermediate click position.

### Sequence for removing the glasses



**ATTENTION!** every procedure must be done with the door removed and placed on an adequate surface in order to not damage the door.

1

Unscrew the 2 screws on the sides in the upper baton



2

Lift the upper glass and pull it out



3

Pull out the middle glass

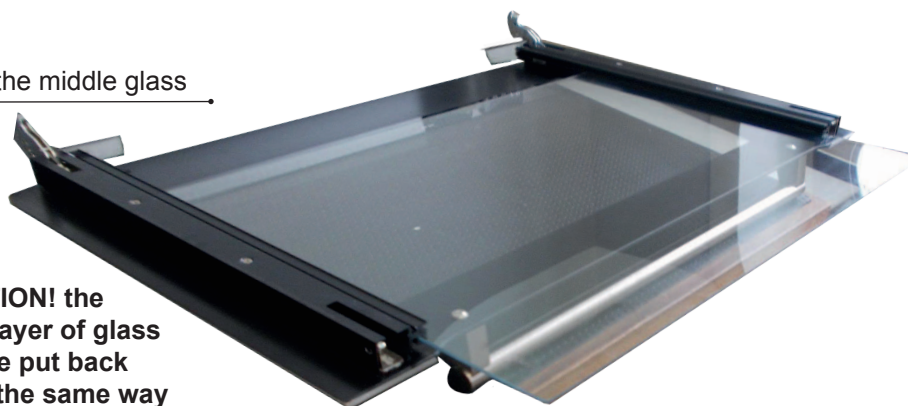

**ATTENTION!** the middle layer of glass **MUST** be put back exactly the same way and direction as it was before it came out

# CLEANING AND MAINTENANCE

## - Recommendations for cleaning the cooktop

**ATTENTION:**



Before carrying out any cleaning operations, disconnect the appliance from the mains and close the gas valve. The cooktop must be cleaned after it has been let cooling down.

### COOKTOP

COMPONENT	CLEANING METHOD	WARNINGS
<b>Steel surfaces</b>	Clean the details with warm water and non-abrasive detergent. Dry with a soft microfiber cloth.	Brilliance is maintained through regular cleaning with specific products which can be found in commerce. Never use abrasive powders.
<b>Enameled surfaces</b>	To maintain the characteristics of the enameled surfaces it is necessary to regularly clean them with soapy water.	Avoid leaving acidic or alkaline substances (vinegar, lemon juice, salt, tomato juice, etc.) on enameled parts and washing them when are still hot.
<b>Cooktop grills</b>	Remove the grills and wash them with warm water and non-abrasive detergent. Carefully remove every encrustation. Dry before placing them back on the cooktop.	Do not wash them in the dish washer.
<b>Spark plugs and thermocouples</b>	Clean with a damp cloth. If necessary, remove dry dirt with a toothpick or a needle.	Spark plugs and thermocouples must be cleaned and checked regularly.
<b>Crowns, gas rings, and caps</b>	Gas rings and caps are removable to allow easy cleaning. Wash them with hot water and non-abrasive detergent.	Carefully remove every encrustation and wait that they are completely dried off. In the case of malfunctioning, make sure that the holes in the external crown are always perfectly cleaned.
<b>Induction or fiberglass</b>	Remove light stains with a humid cloth and dry with a soft cloth.	Don't clean with abrasive products. Don't use any object that could ruin the fiberglass top. Make sure that the bottom of the pan is dry and clean, and that glass surface has no dust. Moving the pan may scratch the glass. Immediately remove residual sugar, jam and jelly to prevent damaging the glass.

# CLEANING AND MAINTENANCE

## - Recommendations for cleaning the oven and the front panel

**ATTENTION:**

Before carrying out any cleaning operations, disconnect the appliance from the mains and close the gas valve. The cooktop must be cleaned after it has cooled down.

### OVEN

COMPONENT	CLEANING METHOD	WARNINGS
Oven inside	It is recommended to clean the oven after every use. Dirt is cleaned more easily avoiding to let it burn several times at high temperatures. Remove every removable part and clean it separately with hot water and non-abrasive detergent. The cavity is cleaned with a soft cloth soaked with a solution made of water and ammonia. Rinse and dry.	Do not use vapor cleaner to clean the interior of the oven. Do not use abrasive/corrosive detergents or sharp tools to clean the glass of the door as they could damage and break the surface.
Tray	Immerse in a solution made of water and neutral soap. Dry afterwards.	Remove residual food immediately after use.
Grills	Clean with a NON-acidic detergent.	Acidic substances such as lemon juice or other acidic detergents may permanently damage the enamel of the grills. Carefully dry the grills with a cloth right after the cleansing. It is not recommended to wash them in the dishwasher.

### FRONT PANEL

COMPONENT	CLEANING METHOD	WARNINGS
Steel surfaces	Clean the parts with warm soapy water and non-corrosive liquid detergent and then dry them with a soft cloth or microfiber.	Brilliance is maintained through regular cleaning with specific products which can be found in commerce. Never use abrasive powders
Enamelled surfaces	To maintain the characteristics of the enamelled parts it is necessary to clean frequently with soapy water.	Avoid leaving acidic or alkaline substances (vinegar, lemon juice, salt, tomato juice, etc.) on enamelled parts and washing them when are still hot.

# CLEANING AND MAINTENANCE

- Maintenance and cleaning of total black burners with nanotechnological coating

---

## ATTENTION!



**Some cleaning and washing methods are recommended in order to preserve the quality of the coating.**

- Allow the product to cool down at room temperature before cleaning it. It is recommended not to dip it in cold water when it is still hot.
- Wash with warm soapy water. Rub with a natural fibre cloth, or non-abrasive sponge.
- Do not use powder, iron wool, cloths and abrasive sponges.
- Do not let food be charred on the burner. In case stains/colorations may appear on the surface. These traces do not alter the functionality of the product, and in some cases can be eliminated with this procedure: immerse the product in hot water, with detergent, wipe gently with a natural fibre cloth; in any case, do not use abrasive cloths or sponges. For the most resistant stains, it is advisable to warm white vinegar and rub as indicated above.
- Avoid leaving the burners in contact with food for a long time, especially if acidic, such as tomato sauce.
- Avoid contact with metal objects; if really needed, use wooden or plastic objects.
- Avoid washing in the dishwasher, a part of the product is not coated and would get irreparably damaged.
- In case of malfunction, make sure that the holes in the outer crown are perfectly clean.

# PROBLEM SOLVING

## - Guide for the resolution

**ATTENTION:**

- During the guarantee period repairs can only be carried out by the authorised after-sales service.
- Before repairing, disconnect the appliance from the mains
- Unauthorised interventions and repairs can cause electrocution or short circuit, therefore do not carry them out. Leave these works to authorized technicians.
- After-sales service intervention during the guarantee period is not free, if the appliance does not work because of incorrect use.
- The elimination of the faults or complaints, caused by incorrect use or installation, will not be repaired under guarantee. In such cases, the repair costs will be borne by the user

### Small solvable problems without the help of a skilled technician

Problem	Causes	Elimination
The flame is uneven / unstable.	Wrong gas setting	Have an expert check the gas setting
The flame from the burners suddenly changes	Wrongly assembled burner parts	Assemble the burner correctly
The flame from the burners suddenly changes	Wrongly assembled burner parts	Assemble the burner correctly
Burner ignition takes more time	Knob pressed for too short a time or too delicately	Keep the knob depressed longer. Before releasing it, press it harder
Spark is uneven	There are food or detergent residues between the igniter electrode and the burner	Carefully clean between the igniter electrode and the burner
The burner covers are dirty	Regular dirt	Clean the burner covers with a metal care detergent.

# COOKING CHART

- Fan oven (purely indicative values)

DISH	TEMP. C°		MIN.
<b>MEATS</b>			
Roast beef	170-180	2/3	40/50
Roast ox	170-190	2/3	40/60
Roast veal	160-180	2/3	65/90
Roast lamb	140-160	2	100/130
Rare roast beef	180-190	2/3	40/45
Roast hare	170-180	2/3	80/100
Roast rabbit	160-170	2	80/100
Roast turkey	160-170	2	160/240
Roast goose	160-180	2/3	120/160
Roast duck	170-180	2/3	100/160
Roast chicken	180	2/3	90/120
<b>FISH</b>	160-180	2/3	15/25
<b>CAKES</b>			
Fruit cake	180-200	2	40/50
Plain square cake	180-190	2	40/45
Brioches	170-180	2	40/60
Sponge cake	190-200	2	25/35
Plain ring cake	160-180	2	35/45
Sweet biscuits	180-200	2	20/30
Yeast cake	190-200	2	30/40
Strudel	160	2	25/35
Savoy biscuits	150-180	2	50/60
Apple fritters	180-200	2	18/25
Biscuits pudding	170-180	2	30/40
Bread	180-200	3	45
Pizza	250	3	10/20
Toast	185-195	2	7

## IMPORTANT

Insert foods when the oven is hot.

## «Grill» baking

When appliances are equipped with grill, baking can be done by keeping the door closed. By using the grill, you can cook meat, fish and even vegetables. At first, we suggest using the upper runner (4). Position the selector on grill and set the temperature at 180°C.

# COOKING CHART

- Natural convection (purely indicative values)

PIETANZA	TEMP. C°		MIN.
<b>MEATS</b>			
Roast beef	225	2/3	60/80
Roast ox	250	2/3	50/60
Roast veal	225	2/3	60/80
Roast lamb	225	2	40/50
Rare roast beef	230	2/3	50/60
Roast hare	250	2/3	40/50
Roast rabbit	250	2	40/50
Roast turkey	250	2	50/60
Roast goose	225	2/3	60/70
Roast duck	250	2/3	45/60
Roast chicken	250	2/3	40/45
<b>FISH</b>			
	200-225	1/2	15/25
<b>CAKES</b>			
Fruit cake	225	2	35/40
Plain square cake	175-200	2	50/60
Brioche	175-200	2	25/30
Sponge cake	220-250	2	20/30
Plain ring cake	180-200	2	30/40
Sweet biscuits	200-220	2	15/20
Yeast cake	250	2	25/35
Strudel	180	2	20/30
Savoy biscuits	180-200	2	40/50
Apple fritters	200-220	2	15/20
Biscuits pudding	200-220	2	20/30
<b>Bakery</b>			
Bread	220	3	30
Pizza	250	2	15/20
Pizza	250	3	10/20
Toast	250	3	5

**IMPORTANT**

Insert foods when the oven is hot.

**«Grill» baking**

When appliances are equipped with grill, baking can be done by keeping the door closed. By using the grill, you can cook meat, fish and even vegetables. At first, we suggest using the upper runner (4). Position the selector on grill and set the temperature at 180°C.

# INFORMATION

- To be reminded to the user

---

## ATTENTION



### THE INSTALLER MUST GIVE THE FOLLOWING INFORMATION TO THE USER

- Verify the integrity of the appliance and the presence of all the product documentation.
- Verify that the appliance has all the expected accessories.
- Verify the correct utilisation of the appliance (use of the oven, thermostat, ignition of the burners).
- Suggest to fill out the warranty form.
- Request that a periodic maintenance service has to be carried out at least every two years.

---

## LEAKING GAS



**In case of gas leaking close the gas supply and disconnect the appliance from the mains. Call the authorised assistance service. Every operation and maintenance must be carried out exclusively by authorised and qualified personnel.**

# INSTALLATION

## - Installation of the cooker

**ATTENTION**



The appliance weighs more than 60 kg, therefore it must be moved with the appropriate tools.

Do not drag the cooker as this will bend the supporting feet. Lift the appliance when positioning it. **DO NOT MOVE/LIFT THE APPLIANCE FROM THE DOOR HANDLE.**

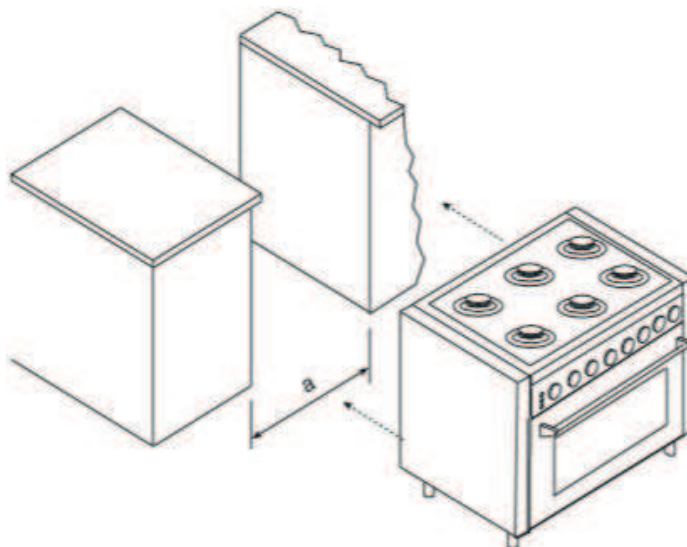

**Measures to be respected**

**a (mm)**

**Models**

900

ALL PRO-LINE COOKERS

**Directives/regulations**

**- This appliance is in compliance with the applicable CE standards and must be installed in compliance with local regulations including AS5601.**

**Room ventilation**

This is a type "A" appliance which does not need to be joined to an exhaust system for combustion waste but must be installed under a hood or other smoke extraction system in compliance with the standards in force.

The knowledge and consultation of the standards are a key factor for a qualified technician. Indicatively the amount of air necessary for burner combustion is 2 m<sup>3</sup>/h for each KW of nominal power installed (see plate).

Should the appliance be subjected to intensive and prolonged use, supplementary ventilation may be necessary; in such cases open a window or increase the extractor fan's power.

# INSTALLATION

## - Installation of the cooker

### Positioning of the appliance between furniture

- The appliance can be installed freestanding (class 1).
  - The appliance can be installed between two pieces of furniture (class 2/1).
- The cooker is protected against excessive overheating, so it may be installed next to furniture with a height no higher than that of the worktop. The wall in contact with the back of the cooker must be made of fire-resistant material. To install the cooker correctly, take the following precautions.
- A.** Any furniture in the vicinity of the cooker with a height higher than that of the worktop must be at least 50mm from the edge of the top;
- B.** The extractor hood must be installed in the way indicated in its instructions booklet, and always at a minimum distance of 650 mm from the top of the hob;
- C.** If the cooker is installed under a wall unit, the minimum distance between this unit and the worktop must be 650mm (millimeters).

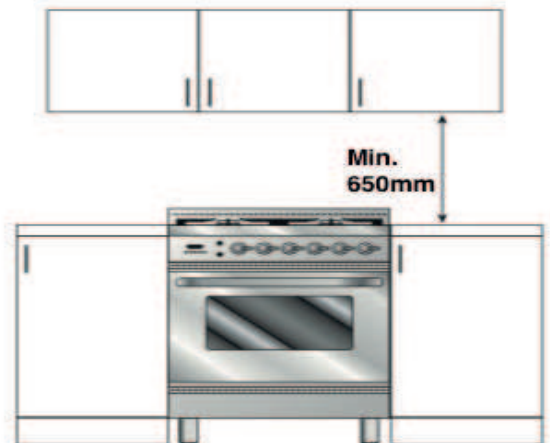
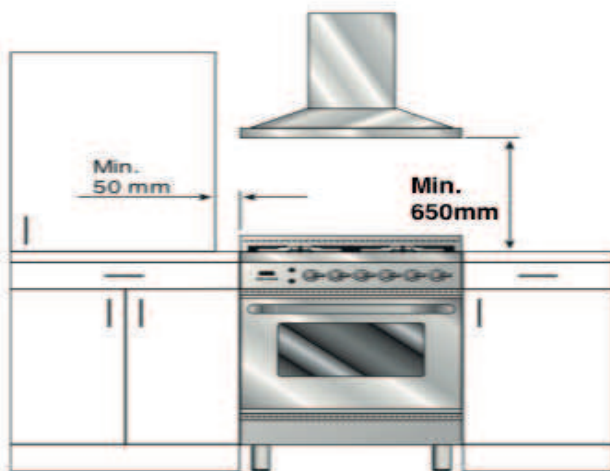

# INSTALLATION

## - How to install the fixing bracket

**Model: 60 & 90cm.**

- Unpack the cooker and mount the feet by adjusting the height.

- Measure the height from the floor to the top edge of the back-cross bar (picture 5) and add 15mm.



- Sign the total height on the supporting back wall at the centre of the cooker width. Make a hole by means of a 6 diam. point and install the fixing bracket (picture 6).



- Check that the cooker is leaning against the back wall to avoid tipping.

**ATTENTION**



The anti-tilt system is assured only if the cooker is installed with the back part leaned against the back wall.

# ELECTRICAL CONNECTIONS

## - Groups of cooking

### ATTENTION



The instructions below are intended for the skilled technician who will install the cooker, regulate it and perform technical maintenance and who will ensure that these operations are carried out in the most correct way possible, in compliance with the regulations in force.

**Important: the cooker must be disconnected from the electric socket before performing all regulating or maintenance operations.**

### Rules for installation

- Installation must be carried out in a workmanlike manner, fully complying with the legislation in force regarding electrical installations. Otherwise, the manufacturer disclaims any responsibility. You will find your appliance's wiring diagram in this booklet.
- The appliances are prepared for connection to the voltage shown on the data plate.
- **Before connecting the appliance to the mains check that: -the electromagnetic switch or the socket are able to support the appliance's load (see dataplate); -the power supply system must have an efficient grounding system.**

The appliance is supplied with a cable but without a plug: the connection must be made taking into account that the green-yellow cable is the ground conductor and it must never be interrupted.

The socket must be visible and easily reachable so that the appliance can easily be disconnected. For direct connection to the mains, it is necessary that:

- the relief valve and domestic system can support the equipment's load (see data plate)
- the power supply system must have an efficient grounding system
- the socket or omnipolar switch, with a minimum 3 mm contact opening, must be easily reachable once the appliance has been installed.
- means for disconnection must be incorporated in the fixed wiring in accordance with the wiring rules

### ATTENTION



The yellow-green ground wire must never be interrupted even by the switch. The power cable should be positioned so that it does not come into contact with surfaces that have a temperature of 50 °C higher than the environment. In case replacement of the power cable is necessary, contact the support service.

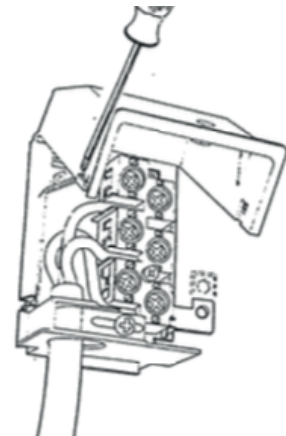

# GAS CONNECTIONS

## - By the Qualified installer

### Instructions

#### a) CLASS (Subclass 2/1 kitchen recessed between furniture)

The apparatus must be connected to the gas mains by means of rigid or flexible metal pipes (maximum length 1.2 metres) suitable for gas appliances.

The connection pipes and their maximum lengths must conform to the applicable standards and connected to the device by means of the ISO R228 threaded fitting (Fig. A) with the interposition of the sealing gasket, or ISO R7 (Fig. A) with metallic seal on the thread (sealing materials may be used as long as they are suitable for gas connections)

#### b) CLASS (Kitchen for free installation)

In addition to the paragraph (a), the connection can also be made with flexible rubber pipe (maximum length 1.2m). Fixed to the hose holder for LPG with the relative clamp; The pipe must be visible and inspected throughout the route with the obligation of replacement at the expiry date, at no point shall it reach temperatures greater than 50 °c, shall not be subject to traction and torsion stresses, shall not present Choke, it must not come into contact with sharp parts, live edges or similar.



**It is recommended to connect the tightness of the connections with special foaming (NO flame).**

### Transformation for Other Gases

The appliance is delivered to operate as indicated on the label on the appliance

### ATTENTION



Any maintenance operation, etc. It must be carried out by an authorized technician after disconnecting the appliance from the mains and closing the gas supply.

# ADJUSTMENT

## - Replacement of the injectors for models

**Procedure:**  
**SR - R - P**

- Remove the grill and the burners from the hob.
- Bruciatori SR – R – P : SR – R – P burners: unscrew injectors “U” using a 7-mm spanner (fig. 1) and replace them with those for the new gas according to table number 2 on page 20.

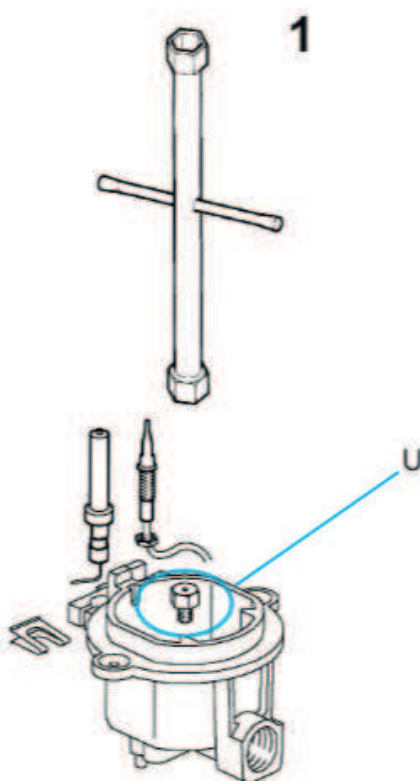

**Procedure:**  
**DCC**

- DCC – Dual burners: unscrew the 2 screws “P” and remove cover “C” fig.2.
- Unscrew injectors “U” using a 7 mm spanner (fig.3) and replace them with those for the new gas according to table number 1 below 13.

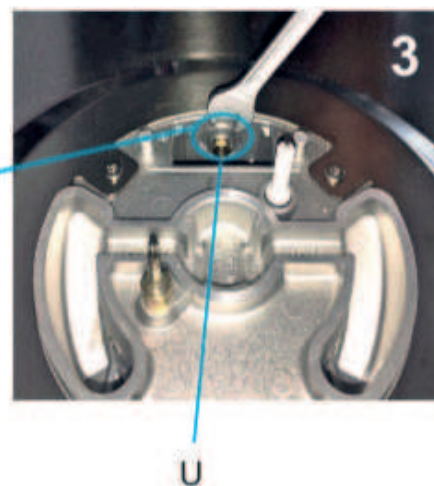
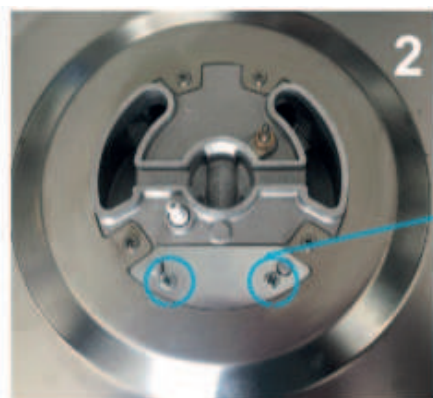

**ADJUSTMENT****- Kitchen table PRO LINE**

Gas type:

**Natural gas @ 1.00kPa Test Point Pressure**

<b>Burner</b>	<b>Injector Size (mm)</b>	<b>N.G.C. (MJ/h)</b>
Dual Wok	1.75 / 0.80	17.0
Wok	1.90	18.0
Large	1.55	12.5
Medium	1.18	7.5

**ULGP @ 2.75kPa Test Point Pressure**

<b>Burner</b>	<b>Injector Size (mm)</b>	<b>N.G.C. (MJ/h)</b>
Dual Wok	1.10 / 0.50	20.0
Wok	1.12	18.0
Large	0.92	12.5
Medium	0.68	7.0

**Test Point Pressure for is 1.0 kPa when approximately 50% of the burners are on high**

# ADJUSTMENTS

## - Adjustments minimum GAS flow

---

### Adjustments

When installing the cooker, you must check that the minimum gas flow of the burners on the hob and in the oven is correctly regulated.

If the type of gas is changed it is imperative to adjust the minimum flow. The regulating procedure is as follows.

---

### - Burners on the hob

1. Light one burner at a time and turn the flame up to maximum.
2. Remove the knob of the corresponding gas tap and insert a screw driver in the end part of the tap or in the screw (fig. A2).
3. Turn the tap to minimum position.
4. Unscrew, turning to the left, to increase the flame, or screw to the right to decrease it.
5. If a liquid gas is used (Butane - Propane), the regulating screw must be fully screwed in.

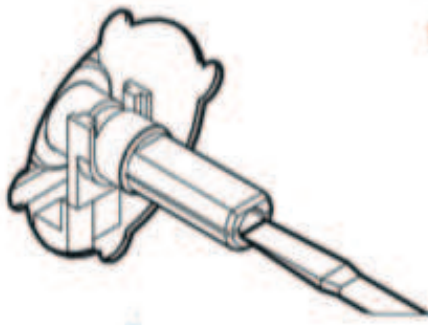
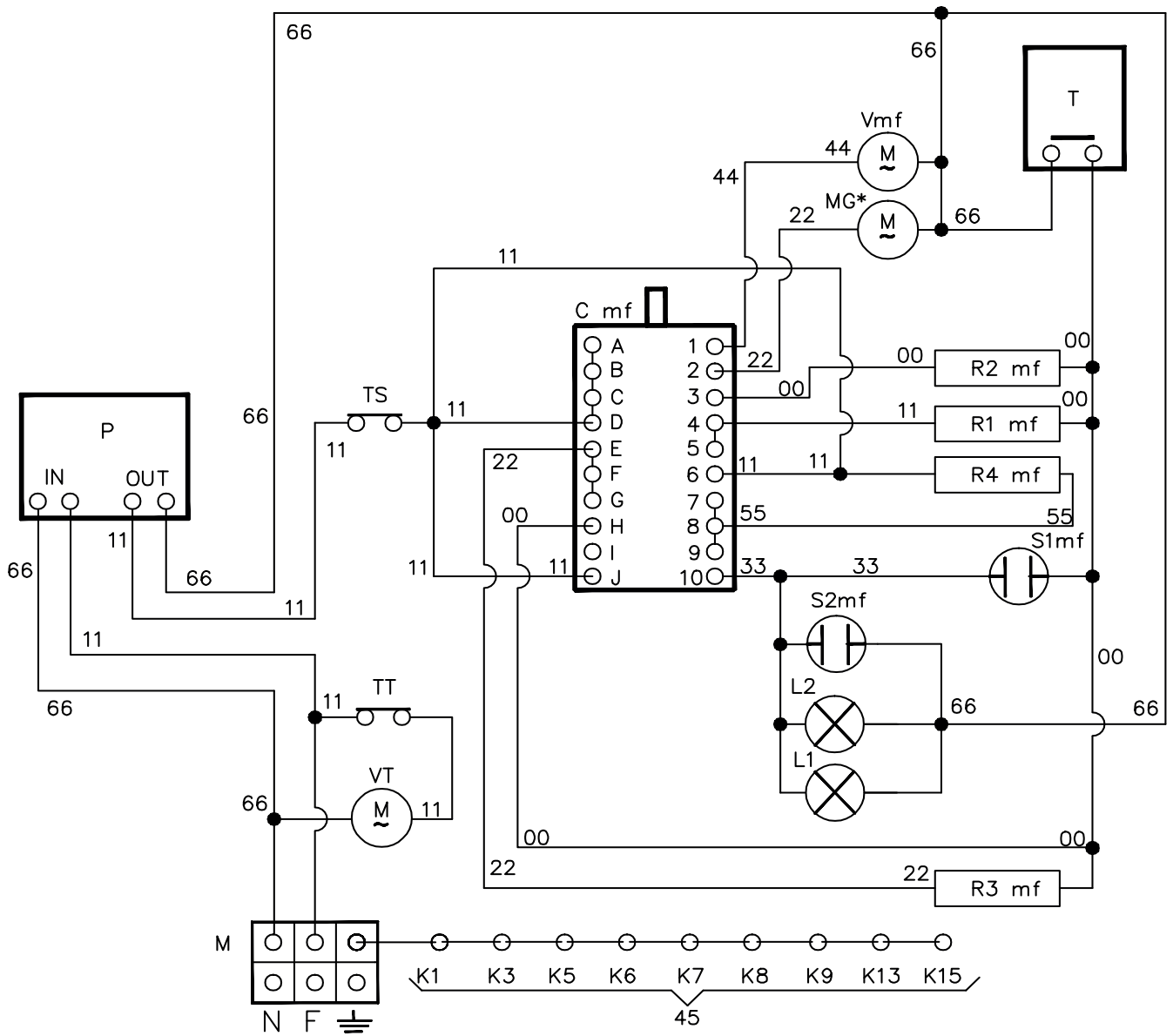

Fig. A1

# WIRING DIAGRAM



# WIRING DIAGRAM

## - Key

00	Black
11	Brown
22	Red
33	White
44	Yellow
45	Yellow-green
66	Blue
AA	Electrical ignition transformer
C	Switch
F	Fuse
K1	Earth wire for terminal board
K2	" " lower resistance
K3	" " for oven fan
K5	" " upper resistance
K6	" " oven lamp 1
K7	" " oven lamp 2
K9	" " cooling fan
K10	" " selector
K11	" " oven thermostat
K13	" " grill
K15	" " frame

K17	" " fryer
L1	oven lamp
L2	oven lamp
M	Terminal board
MA	Electrical ignition microswitch
N	Neutral
P	Timer/Programmer
R1	Upper heating element
R2	Lower heating element
R3	Grill heating element
S1	Oven warning light
S2	Mains power warning light
SP	Sparking plug
TF	Oven thermostat
TS	Safety thermostat
TT	Cooling fan thermostat
V	Oven fan
VT	Cooling fan







10/55 Howe St  
Osborne Park, WA

1/42 Cavendish Rd  
Coorparoo, QLD

48-50 Moore St  
Leichhardt, NSW

1211 Toorak Rd  
Camberwell, VIC

## NATIONAL SERVICE CENTRE

Our high quality appliances are designed and manufactured to give you many years of cooking pleasure. Should you have any questions or issues with your appliance please email our national service centre [customercare@eurolinx.com.au](mailto:customercare@eurolinx.com.au) or phone us on **1300 85 64 11**.

Our experienced staff are on hand to log your service request and ensure any matter is attended to promptly.



**FOLLOW US ON:**



[facebook.com/ILVEappliances](https://facebook.com/ILVEappliances)



[instagram.com/ILVE\\_appliances](https://instagram.com/ILVE_appliances)



[youtube.com/ILVEappliances](https://youtube.com/ILVEappliances)

**BLOG** [livewithilve.com](https://livewithilve.com)

**Australia National Telephone Number 1300 MYILVE (694 583) New Zealand Telephone Number 64 3 344 5913**

**ILVE showroom hours:** Tuesday to Friday - 9am-5pm, Saturday - 10am-4pm, Sunday and Monday - closed

**\* Melbourne showroom hours:** Tuesday to Saturday - 10am-4pm

[ilve.com.au](https://ilve.com.au)

**NSW & ACT (Head Office)**

48-50 Moore Street  
Leichhardt  
F 02 8569 4699

**VIC & SA**

1211 Toorak Road  
Camberwell  
F 03 9809 2155

**QLD**

1/42 Cavendish Road  
Coorparoo  
F 07 3397 0850

**WA & NT**

Unit 10/55 Howe Street  
Osborne Park  
F 08 9201 9188

**New Zealand**

PO Box 11.160  
Sockburn Christchurch  
F 03 344 5906

