

2-Zone WiFi Water Timer with Gateway Set

USER MANUAL

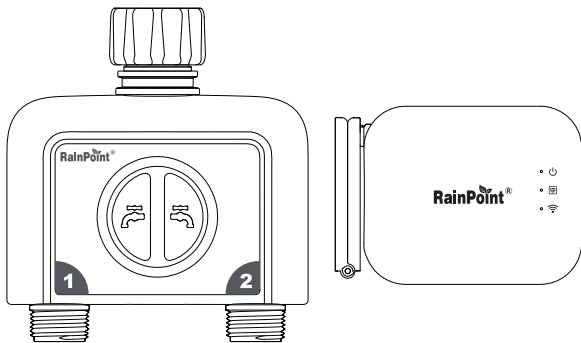

Model No. HTV245FRF+HWG040WLBRF



WhatsApp
+1 626-780-5952



Email
service@rainpointonline.com



Free Hotline
US: +1 833-381-5659 (EN)
DE: +49 800-182-0576 (DE, EN)
UK: +44 800-808-5337(EN)

EN	01 - 55
ES	56 - 111

CONTENT

1. INTRODUCTION	01
1.1 Contents in the Box	01
1.2 Product Overview	02
1.3 Specification	04
1.4 Feature Overview	05
2. INSTALLATION AND CONNECTION	07
2.1 Install App On your Phone	07
2.2 Connect the Gateway to the WiFi	08
2.3 Connect the Timer to the Gateway	17
2.4 Install the Timer to the Faucet	22
2.5 Activate the Timer Before Use	23
3. APP INTRODUCTION	24
3.1 Timer Homepage	24
3.2 Basic Setting	26
3.3 Plan Setting	29
3.4 Manual Water Setting	34
3.5 Built-in Water Flow Meter & Chart	36
3.6 Device Status Record & Event	37
3.7 Rain Delay	38
3.8 Smart Scene	39
3.9 Weather Conditions & Devices' Next Plan Time	44
3.10 Plan Overview & Setting	45
3.11 Home Management	46
3.12 Google Assistant/Alexa Voice Control	47
4. RESET THE DEVICE	48
5. THE MEANING OF LED LIGHT	49
6. TROUBLESHOOTING	51
7. LIMITED WARRANTY	53
8. CUSTOMER SERVICE	54

1. INTRODUCTION

1.1 Contents in the Box

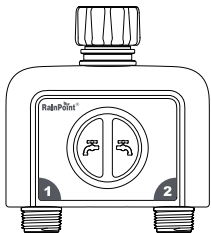

1

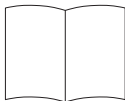

3



5

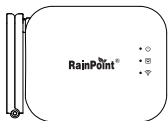

2

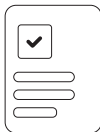

4

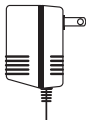

6

1. 1× HTV245FRF 2-ZONE WiFi WATER TIMER
2. 1× HWG040WLBRF WiFi Gateway
3. 1× User Manual
4. 1× Quick Guide
5. 1× Type C USB Cable
6. 1× Adapter

1.2 Product Overview

WiFi Timer

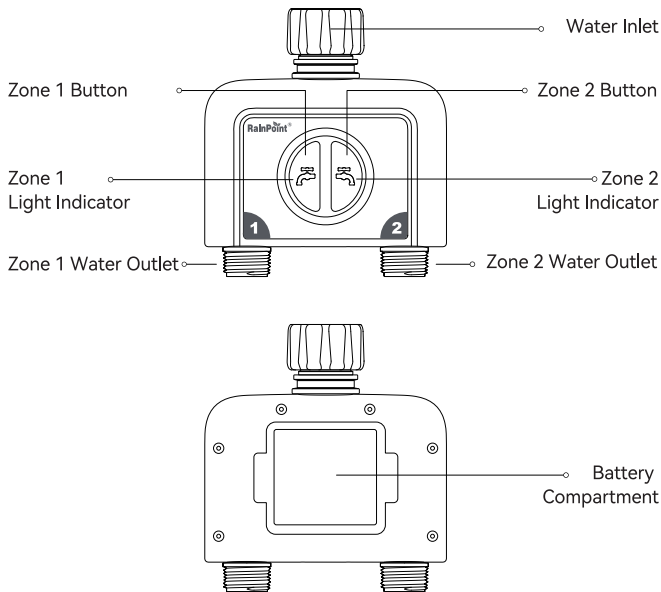

WiFi Gateway

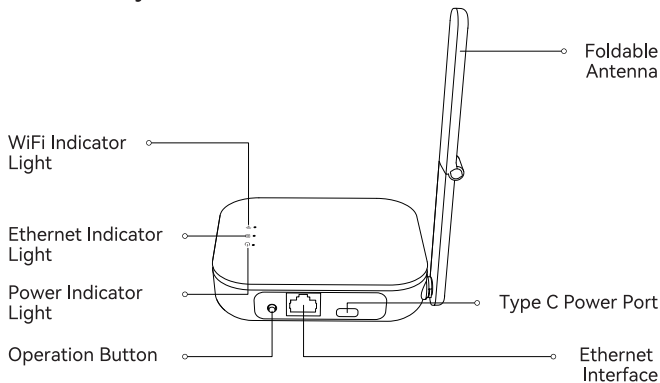

Button function: Press and hold the button for about 5 seconds to activate WiFi connection mode, and the WiFi indicator light will flash quickly, indicating pairing mode.

1.3 Specification

WiFi Timer		
SERIAL NUMBER	ITEM	SPECIFICATION
1	Range Between Gateway And Timer	An open distance up to 250m/820ft
2	Working Water Pressure	0.5 bar to 8 bar(7.25-116PSI)
3	Water Flow Rate	5-35 L/Min (1.32-9.25GAL/Min)
4	Working Temperature Range	3°C-50°C(37.4°F-122°F)
5	Powered By	4 * AA alkaline batteries (not included)
6	Waterproof Level	IP 65
7	Water Inlet	NH (US) for 3/4" faucets BSP (EU) for 3/4" or 1" faucets
8	Water Outlet	For 3/4" standard garden hose
WiFi Gateway		
SERIAL NUMBER	ITEM	SPECIFICATION
1	Distance Between Gateway And Router	220m (722ft)
2	Powered By	Type C plug-in power supply
3	Working Temperature Range	3°C-40°C(37.4°F-104°F)
4	WIFI Frequency Band	2.4GHz

1.4 Feature Overview

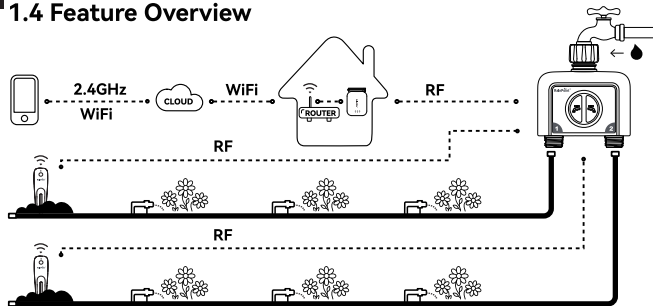

1. **WiFi Remote Control:** Connect with 2.4GHz WiFi, set and check irrigation schedules by APP.
2. **Scheduled Watering:** The timer can set up to 6 separate watering plans for each valve for all three different modes.
3. **Manual Watering:** Manually turn on/off watering and set watering duration for three different modes.
4. **Automatic Watering:** When the WiFi timer is paired with the WiFi soil sensor(not included), it can automatically irrigate or stop watering according to the soil temperature and humidity data; when you locate the home address for the timer, the APP will automatically synchronize the local weather information, and the timer can be automatically executed according to the weather trigger conditions you set.
5. **Rain Delay:** Manual rain delay and automatic rain delay can be set.
6. **Water Flow Meter:** Built-in water flow meter to track water usage in the last 30 days or the last year.
7. **Three watering modes:** Normal Irrigation; Interval Irrigation; Cycle & Soak.

8. **Comanagement with family:** Home management allows you to add family members and give them permissions to manage the irrigation of your home garden together.
9. **Low Battery, Water Shortage, Valve Failure (leakage) Alarm:** APP will send you alert messages when low battery, water shortage or valve failure.
10. **One WiFi gateway can pair with maximum 4 WiFi water timers.**
11. **Each valve of the WiFi water timer can pair with one WiFi soil sensor.**

2. INSTALLATION AND CONNECTION



Setup Video



Customer Support

Tips: Please scan the QR code or search the link for setup video or customer support to install the device quickly.

Setup Video:

www.youtube.com/@rainpoint

Customer Support:

www.rainpointonline.com/pages/support

2.1 Install App On your Phone

1. Download the RainPoint Home App
Search for "**RainPoint Home**" on Google Play or App Store or scan the QR code to download the RainPoint Home APP.
2. Register your RainPoint Home account
Open your RainPoint Home APP, select **Register**. Follow the prompts to register a RainPoint Home account with your email or mobile number.



iOS



Android

RainPoint Home

<

Register

Join us

United States of America +1 >

2.2 Connect the Gateway to the WiFi

2.2.1 Preparation for Connection

To ensure your gateway connects to your phone, it must meet the following requirements:

- Before using the RainPoint Home app to connect the device, please ensure that your phone is connected to a **2.4GHz WiFi network**, as the gateway must operate on 2.4GHz WiFi.
- **IOS Requirement: iOS 11.0 (or later)** mobile device with cellular data or WiFi service.
- **Android Requirements: Android OS 6.0 (or later)** mobile device with cellular data or WiFi service.
- Do not use public Wi-Fi networks.
- During the pairing process, keep the gateway and your phone within 10 feet (3 meters) of each other.
- If you need to change the connected WiFi network, press and hold the operation button on the gateway to reset it (please refer to 4 RESET THE DEVICE in the manual for instructions) and reconnect.

2.2.2 WiFi Connection

Follow the steps below to complete the device connection, ensuring that the gateway is close to the router during the connection process.

- a. Select the "+" icon in the top right corner of the app homepage to add a device, or you can click the **"Add Device"** on the app homepage to add a device.

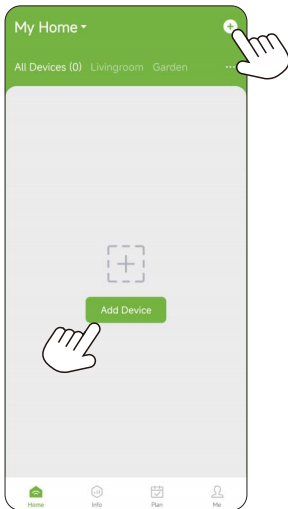

- b. Find and select **"HWG040"** or scan the SN code on the device and then proceed to the next step.

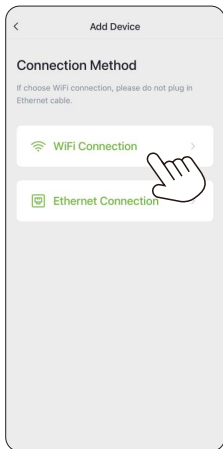
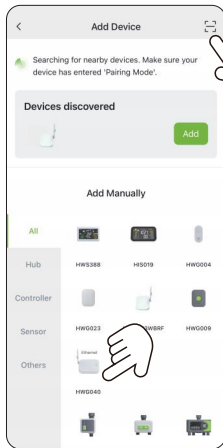

- c. Choose **"WiFi Connection"**.

- d. Enter the WiFi password and click "Next".

NOTE: Please make sure to connect to your 2.4GHz WiFi for the device pairing.

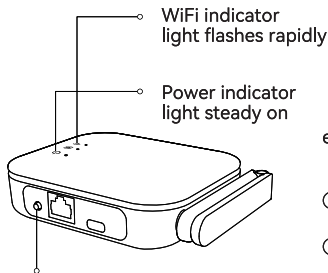

Press and hold the button to enter pairing mode

- e. Follow the prompts on the page to complete the connection.
- ① Power the gateway using the Type C USB cable.
 - ② Press and hold the button until WiFi indicator light on the device flashes **GREEN** rapidly, indicating that the device is in pairing mode.

f. Click **"Next"** to enter pairing mode in the app.

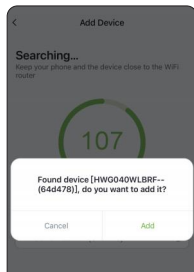
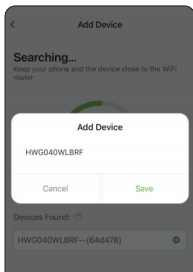
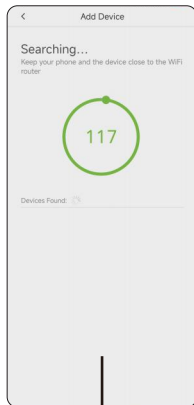

- g. Congratulations! The device has been successfully connected, and the gateway icon will display on the app homepage. You can click the gateway icon on the app homepage to enter the gateway homepage for more settings of the device.

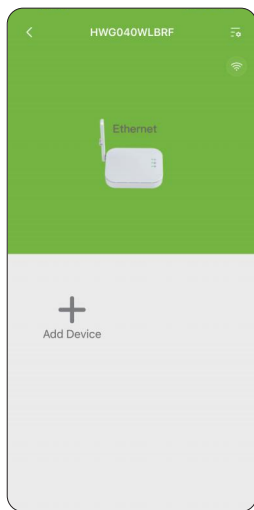
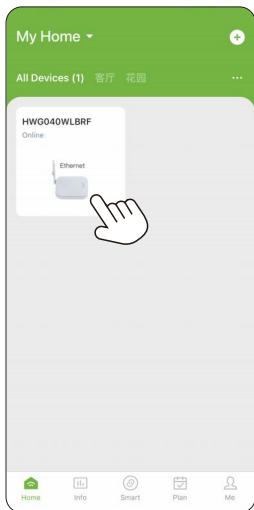

2.2.3 Ethernet Connection

- a. Open the **"Add device"** page, select the **"HWG040"** device, and then choose **"Ethernet Connection"**.

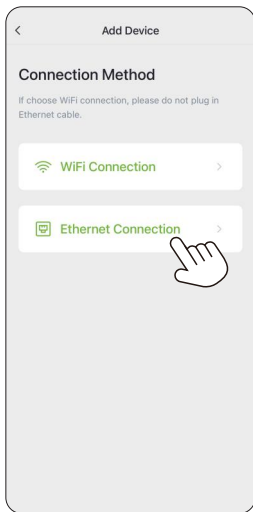

- b. Scan or enter the SN code on the device to proceed to the next step of device connection.

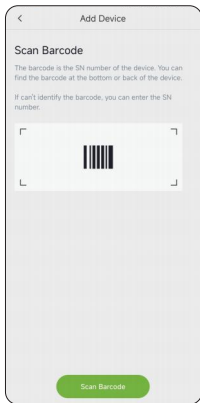

Scan the SN code

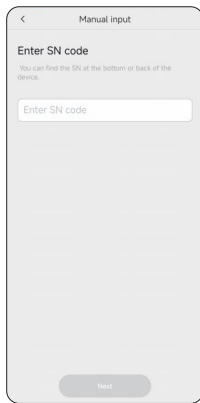

Enter the SN code

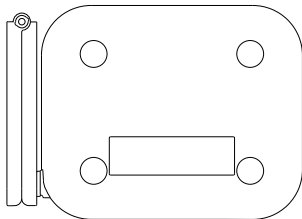

NOTE: When scanning the device's SN code, the app requires access to your phone's camera permissions.

- c. Plug in the Type C USB cable to power the gateway and connect the Ethernet cable. When the Ethernet indicator light starts flashing, the gateway enters connection mode. Then click **"Next"** to continue automatically adding the device.

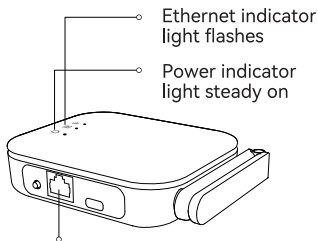

Plug in the Ethernet cable

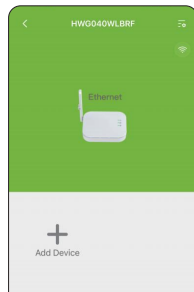
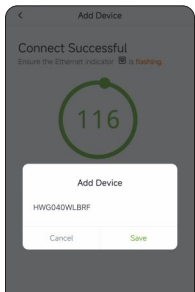
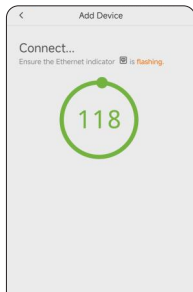

2.3 Connect the Timer to the Gateway

- a. After successfully connecting to the gateway, tap the gateway icon on the app homepage to go to the gateway's homepage, tap **"Add Device"** and then tap **"Add New Devices"** to add the timer to the gateway's sub-device.

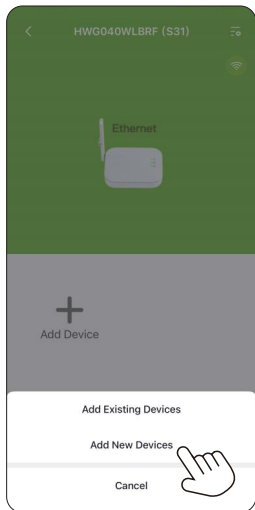
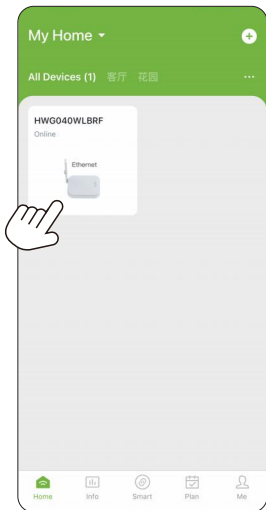

- b. Find and select “HTV245FRF” to add it, or click the icon in the top right corner to add a device via QR code scanning or by entering the serial number. And it will enter the device pairing preparation page.



0220245300

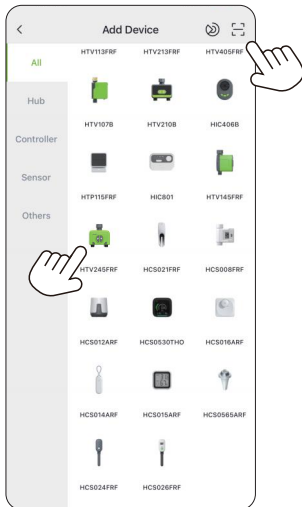

- c. Install the batteries in the timer, then press and hold the device button until the **RED** light flashes rapidly, indicating that the device is in pairing mode.

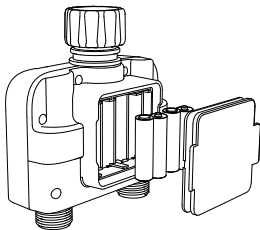
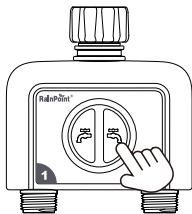

- 1) Open the battery compartment cover of the timer.
- 2) Insert 4 new AA (1.5V) alkaline batteries (not included).
- 3) Close the battery compartment cover and press down firmly to ensure it is fully sealed.



Attention:

- After installing the batteries, securely attach the battery cover to ensure waterproofing.
- If the timer will not be used for an extended period, please remove the batteries and dispose of them properly.
- Replace the batteries when the low battery indicator appears on the display.
- Do not throw batteries into fire, as they may explode or leak.
- To ensure longer life, use 4 new AA alkaline batteries (not included). Do not mix new and old alkaline batteries, standard batteries (carbon zinc), or rechargeable batteries.

- d. Click **"Next"** and it will start pairing the timer automatically.

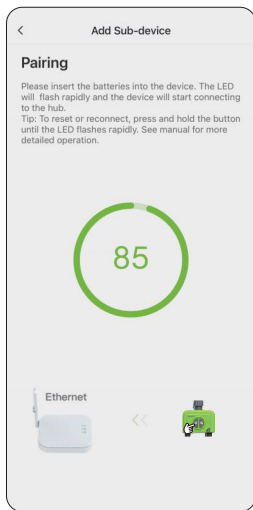
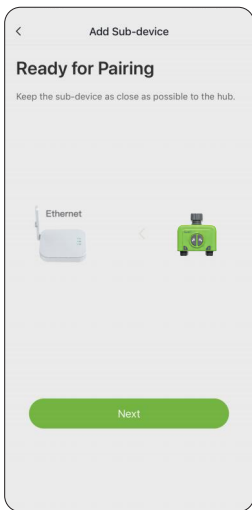

- e. After the device is successfully connected in the app, the timer icon will display on the app homepage. You can click the timer icon on the app homepage to enter the timer homepage for more settings of the device.

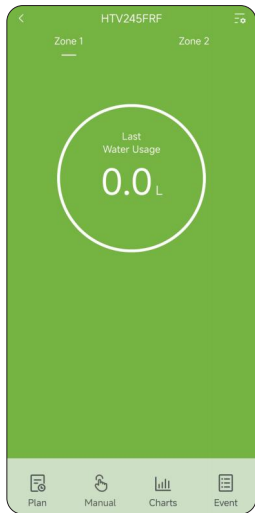
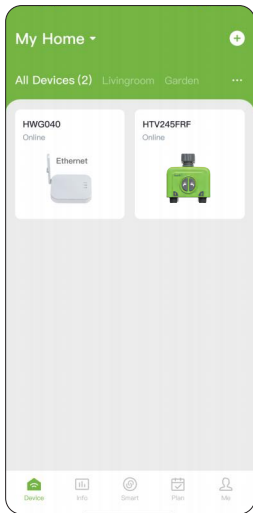

NOTE: Ensure that your gateway and timer remain close during the pairing process. If you need to re-pair or restore factory settings at any time, press and hold the operation button until the red indicator light flashes quickly to manually activate pairing mode.

2.4 Install the Timer to the Faucet

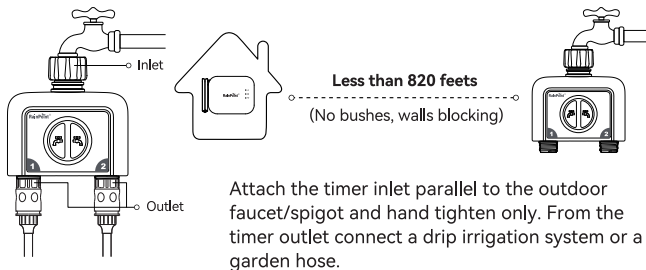

Attach the timer inlet parallel to the outdoor faucet/spigot and hand tighten only. From the timer outlet connect a drip irrigation system or a garden hose.

Warning:

- The WiFi timer can only be used for cold water.
- The WiFi timer uses a 433MHz RF connection to communicate with the WiFi Hub, and must be within a 820ft range, line of sight, of the WiFi Hub. **If there are walls, iron gates or bushes blocking, please shorten the distance between them to better receive the signal.**
- Soil will absorb WiFi and RF signals, the best location of the timer is on the faucet 4 to 8 feet (1.2 to 2.4 meters) above the ground.
- Do not place the WiFi timer in an underground valve box or anywhere your WiFi and RF signal will be obstructed.
- Under freezing weather, the water timer should be removed from the tap and placed properly indoor to avoid any danger of freezing.

2.5 Activate the Timer Before Use

Please activate the valves when getting the timer for the first time, or it's been a long time since your last time to use it.

- 1) Pulling out the battery box and install 4*AA batteries.
- 2) Keep the faucet closed.
- 3) Press the Zone 1/Zone 2 button and you can hear a click sound indicating that the Zone 1/Zone 2 valve is opened for manual watering. After a few seconds, press the Zone 1/Zone 2 button again and you will hear a click sound indicating that the Zone 1/Zone 2 valve is closed.
- 4) **Test:** Turn on the faucet a little bit. Press the Zone 1/Zone 2 button to check if the water flows out or shuts off as expected.

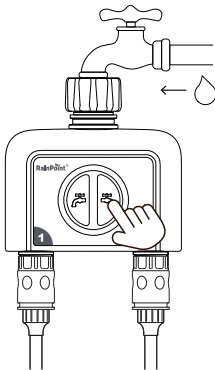

If yes, the timer valves are activated successfully, please use the timer with confidence.

If not, please repeat the step 2~4 for several times, or contact us immediately for support.

NOTE: When testing, please keep away from the water timer outlet to avoid being splashed and wet.

3. APP INTRODUCTION

3.1 Timer Homepage

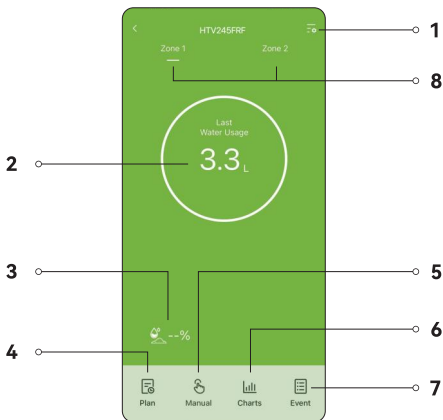

1. **Setting**

Tap the setting icon on the top right corner, you will enter the page for device setting, pair with soil sensor and customize the device watering.

2. **Last Water Usage**

The WiFi water timer has a built-in water flow meter, it will calculate the water usage and display the last time irrigation water usage here.

3. **Soil Moisture**

If you have paired a soil sensor with the timer, it will display the soil moisture here.

4. Plan

Tap **"Plan"** and you will enter the plan set page, up to 6 plans are available for each valve. You can choose from **"Normal Irrigation"** **"Interval Irrigation"** **"Cycle & Soak"** to set your irrigation plans according to your irrigation needs. You can also set **"Rain Delay"** for rainy days by 24/48/72H and set seasonal adjustment to adjust the working time according to the moisture difference of different seasons. Tap the calendar icon to check your plans.

5. Manual

Tap **"Manual"** and choose **"Normal Irrigation"** to set the watering time from 1min to 12h for one-time manual watering, and then tap **"Confirm"** to start watering. While the manual watering is running, tap **"Manual"** and then tap **"Confirm"** to stop watering. You can also choose **"Interval Irrigation"** or **"Cycle & Soak"** to set interval watering to set water time and interval time for 1s to 60mins or 1min to 12h according to your irrigation needs.

6. Chart

Tap **"Chart"** to check the last 30 days or the last year's water usage.

7. Event

Tap **"Event"** to check the online/offline status and irrigation records.

8. Zone 1/Zone 2 Valve

Choose to manage plans or manual watering for the left/right zone.

3.2 Basic setting

Find the icon in the top right corner of the app's homepage to access the "Setting" page. You can view and manage the timer's basic information, and you can also set some advanced settings for specific functions. For example, for ZONE 1:

Interval Irrigation: You can set for the water time and interval time for both Zone 1/Zone 2 from 1s-60mins.

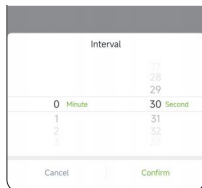
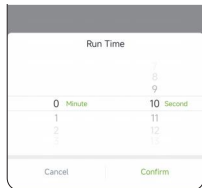
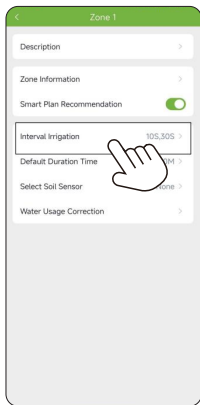
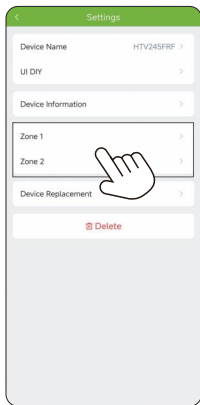

Default Duration Time: You can set the default duration time from 1min-12h.

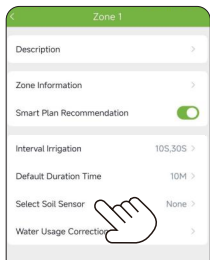
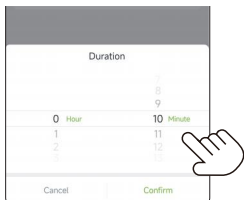

Soil sensor: If you have a WiFi soil sensor, you can pair the soil sensor to the timer here. It will display the soil moisture on the timer's homepage and stop the plan automatically when the moisture reaches to the set value for irrigation delay.

*Each valve of the WiFi water timer can pair with one WiFi soil sensor.

NOTE: The soil sensor is not included, if you need one, please contact us to know more information of the soil sensor that can pair with the timer.

US toll free: +1 833-381-5659(Mon-Fri: 9:30 AM-5:30 PM PST)

DE toll free: +49 800-182-0576(Mon-Fri: 9:00 AM-5:00 PM CET)

UK toll free: +44 800-808-5337(Mon-Fri: 9:00 AM-5:00 PM CET)

Email: service@rainpoinonline.com

WhatsApp: +1 626-780-5952

"Stop Plan" Moisture: After pairing a WiFi soil sensor, you can set the **"Stop Plan" moisture** value for soil moisture to prevent overwatering of plants. Once the soil moisture exceeds this value, all scheduled plans will stop, and they will resume when the moisture drops below this value.

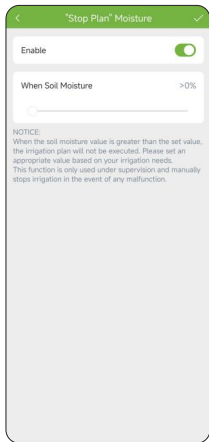

Water Usage Correction: When the water usage record is incorrect, you can calibrate the record here from -20% to 20%.

3.3 Plan Setting

Tap **"Plan"** at the bottom left corner of the timer's homepage to set the irrigation plans.
Up to 6 plans can be set for a valve.

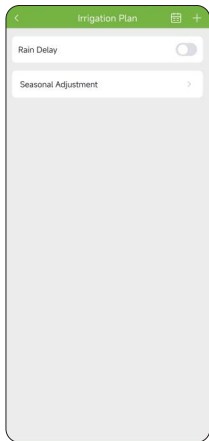
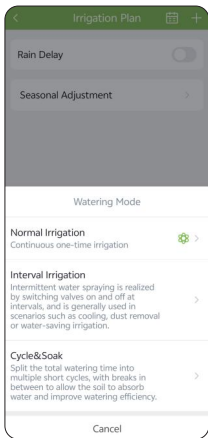

First tap the **"+"** icon on the top right corner of the **"Irrigation Plan"** page to choose your desired irrigation mode from **"Normal Irrigation"** **"Interval Irrigation"** **"Cycle & Soak"**.

Normal irrigation: Set the start time, stop watering method, duration, frequency, and effective date.

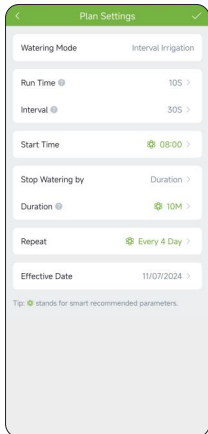
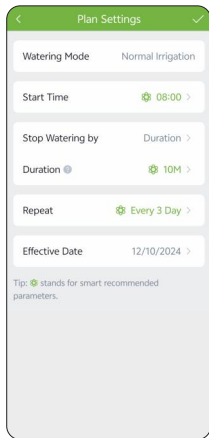

Interval irrigation: Set the run time for watering, interval time, start time, stop watering method, duration, frequency, and effective date. You can set the run time and interval time from 1s-60mins.

Cycle & Soak: Set the water cycle duration, soak duration, start time, stop watering method, duration, frequency, and effective date. You can set the cycle and soak duration from 1min to 12h.

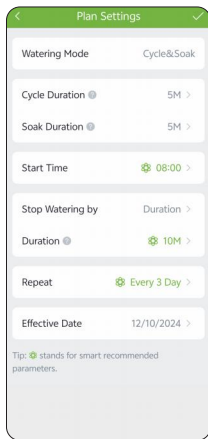

Two Methods to Stop Watering: Duration of operation or water usage.

Water Frequency: Set the watering frequency for your schedule with five options: everyday, odd days, even days, interval, and custom.

Everyday ✓

Odd Dates

Even Dates

Interval

Custom

Cancel Confirm

Plan Settings ✓

Watering Mode Normal Irrigation

Start Time 08:00 >

Stop Watering by Duration >

Duration 10M >

Repeat Everyday >

Effective Date 12/10/2024 >

Tip: ⚙️ stands for smart recommended parameters.

Delete

Save and Delete A Plan: After completing the settings, press the "✓" in the top right corner to save your plan. You will see a plan overview displayed in the list on the "**Irrigation Plan**" page. If you need to delete a plan, click on the plan to enter the plan details page, then click the delete button to remove it.

Seasonal Adjustment: You can set the seasonal adjustment value from 10%-200% for different seasons to adjust the actual watering time for the timer according to the different moisture in different seasons.

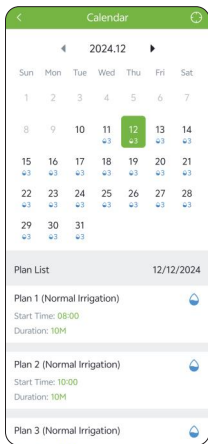

Calendar: Tap the calendar icon on the top right corner on the "Irrigation Plan" page, and you can check the overview of all your watering schedules.

3.4 Manual Water Setting

Select "**Manual**" at the bottom of the timer's homepage to choose the type of manual irrigation: **Normal Irrigation**; **Interval Irrigation**; **Cycle & Soak**. Default watering is 10mins. You can start the manual watering by 2 methods:

Method 1: Timer Homepage

On the timer's homepage, click "**Manual**" to select the manual watering mode and time to start and stop the manual watering automatically.

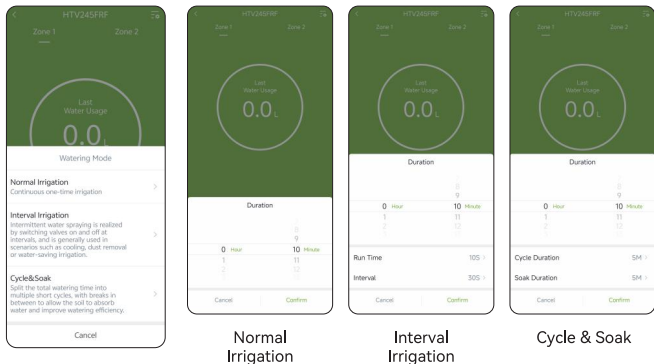

Method 2: Timer Button

Press the Zone 1/Zone 2 button on the timer to open the Zone 1/Zone 2 valve for manual watering; press again to close the valve.

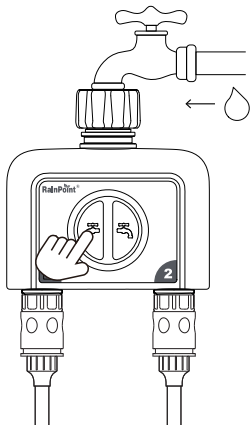

NOTE: When you start manual watering, if there is an existing schedule currently running or if a schedule is set to start during your manual watering time, that scheduled plan will be skipped.

3.5 Built-in Water Flow Meter & Chart

The timer is designed with a built-in water flow meter, it will record the water usage for the irrigation. You can tap **"Chart"** at the bottom of the timer's homepage to check the last 30 days or the last year's water usage records.

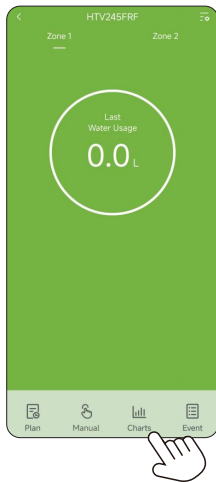

3.6 Device Status Record & Event

Tap "**Event**" on the bottom of the timer's homepage to check the online/offline status and irrigation records. You can select to view the events of ZONE 1, ZONE 2 or all zones. You can also enter "**Event**" page through the steps below: **Me – Event**.

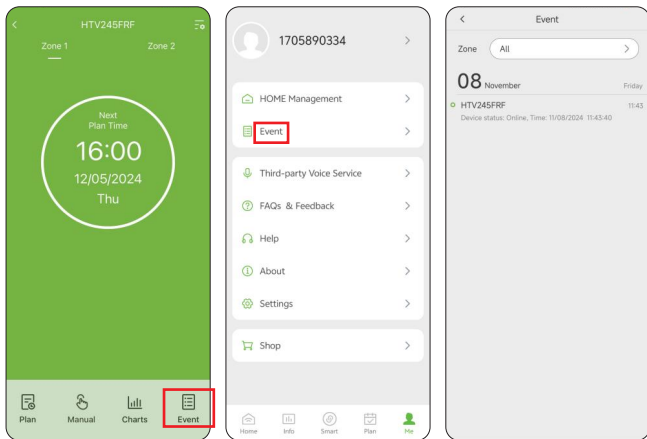

3.7 Rain Delay

You can set the **"Rain Delay"** time on the **"Irrigation Plan"** page by tapping **"Plan"** on the bottom of the timer's homepage, or you can set it on the **"Plan"** page below. Rain delay is applicable on rainy days or during other weather conditions that cause high soil moisture. During the rain delay, the timer will stop watering. Once the rain delay ends, the timer will proceed according to the next scheduled watering plan. The timer can be set for a rain delay of **24, 48, or 72 hours**.

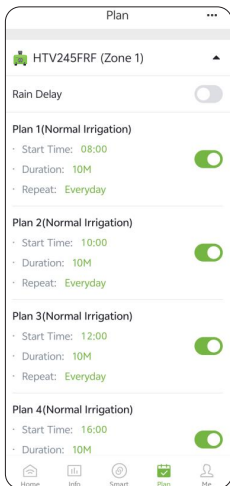
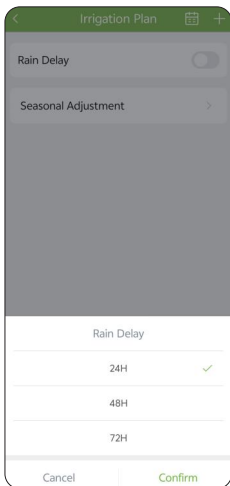

3.8 Smart Scene

The Smart Scene function allows you to set schedules for the devices execute automatically according to the set conditions such as device status, time and weather. For example, RAINPOINT HOME APP can obtain weather forecast information of your home location. When you set the condition for immediately delaying the watering plan when it rains, the timer will automatically execute the watering delay when it rains in your local area. You don't need to worry about whether it is raining at home when you are traveling.

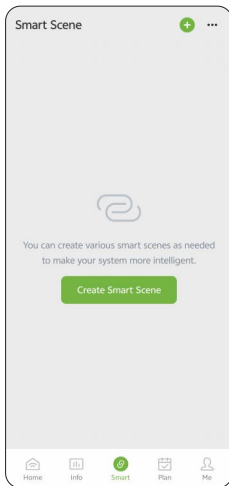

Steps to Set Smart Scene

- 1) **Create Smart Scene:** Go to the "Smart" page, tap "Create Smart Scene" or the "+" icon on the top right corner to add an automation task.
- 2) **Add Condition:** Set the conditions that the device needs to perform when the conditions are met.
- 3) **Add Task:** Set the tasks for the device to perform when the set conditions are met.
- 4) **Effective Period:** Customize the time for the device to perform the smart schedule.
- 5) **Execution Frequency:** Set the frequency for the device to run the smart schedule cyclically daily.
- 6) **Save the Smart Scene Schedule:** Click "Confirm" and enter the name for the schedule and then click "Confirm" to save the setting for the smart scene. The device will automatically execute the smart schedule according to what you set. You can check the smart scenes you set on the "Smart" page.

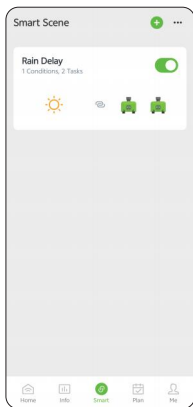
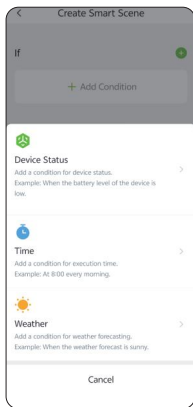

How to set automatic rain delay?

- 1) Tap **"Smart"** at the bottom of the APP home screen.
- 2) Tap **"Create Smart Scene"** or the **"+"** icon on the top right corner to add an automation task.
- 3) Tap **"Add Condition"**, then select **"Weather"**; locate the city, select **"Type Of Weather"** and then select **"Heavy rain"**; tap **"Confirm"** to continue.

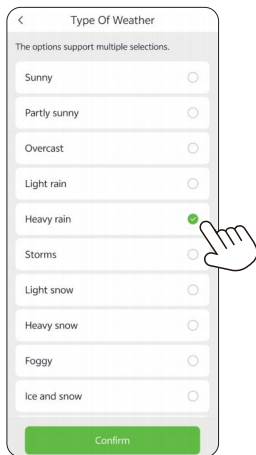
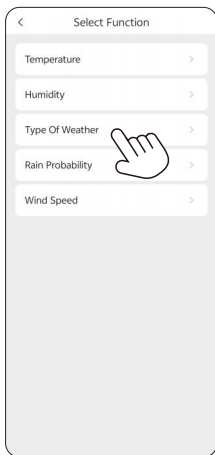

Note: Please accurately locate the city where your home is located. The APP will automatically obtain weather forecast data based on the city you locate. When the weather forecast turns to heavy rain, the conditions for execution will be triggered.

- 4) Tap **"Add Task"**, select **"Control Device"** to set up a task about the device operation.
- 5) Select **"HTV245FRF"**.
- 6) Tap **"All Plans Delayed"** of Zone 1 to set the delay days and tap **"Confirm"**; then tap the **"+"** icon on the right of **"Then"** to set the **"All Plans Delayed"** of Zone 2.

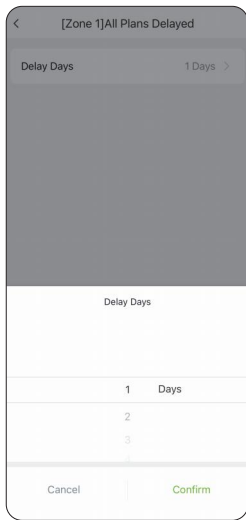
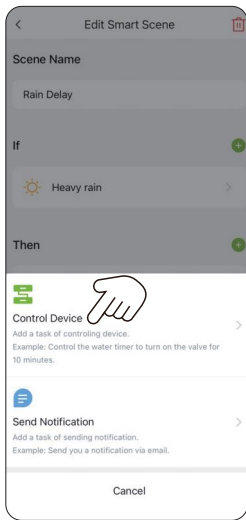

Note: For the task performed by the device, select **"Control Device"**.

- 7) Check your execution conditions and tasks.
- 8) Tap **"Create"** to save your settings.

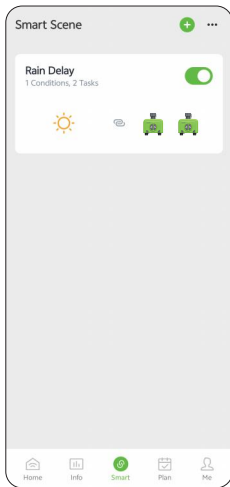
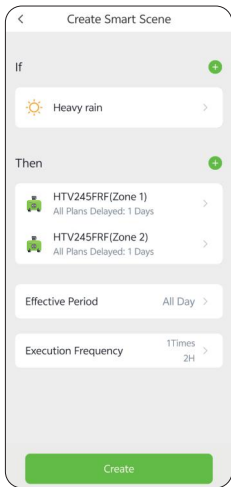

For example: The picture on the left shows that when the weather in New York is heavy rain, the Zone 1/Zone 2 valves of the HTV245FRF WiFi irrigation timer will be automatically closed, and watering will be delayed for one day.

3.9 Weather Conditions & Devices' Next Plan Time

In the **Info** screen, you can check for the weather conditions, last water usage and next watering time of each valve of the timer. For the first time, you need to tap "**Get Location**" and then tap "**Save**" to save your location information, and the **Info** screen will display the weather conditions of the day, including temperature, humidity, rain forecast, wind direction and wind speed, as well as the next 7-days' weather conditions. You can also correct your location information as follows: **Me - HOME Management - My Home - Location - Get Location - Save**. The weather information can help you with decisions of whether to adjust your watering schedules according to the weather. Tap the icon on the top right corner of **Info** screen to turn on/off weather display, or add/delete valves' last water usage and next plan time display of the devices.

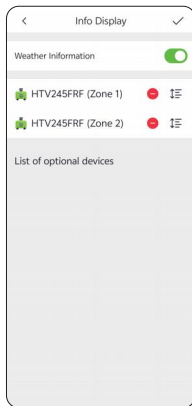
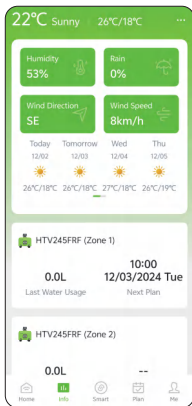

3.10 Plan Overview & Setting

In the **Plan** screen, you can check the plan you set of all your connected devices and adjust each plan here conveniently. You can also set the **Rain Delay** by **24/48/72H** easily or turn off the **Rain Delay** schedule through the button on the right or the icon on the top right corner.

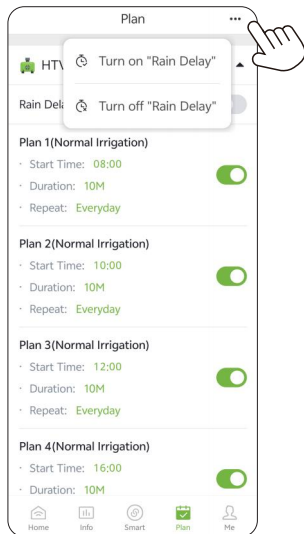
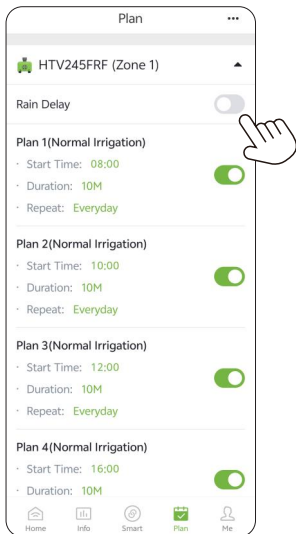

3.11 Home Management

Rainpoint supports adding family members and sharing your home device to achieve co-manage the home irrigation system with your family.

- 1) Tap **Me** at the bottom of the APP home screen.
- 2) Select **HOME Management**. You can set the current home or create a new home.
- 3) Set your **HOME Name, Room or Zone, Location, Time Zone, Members, Units Format** and **Currency**.

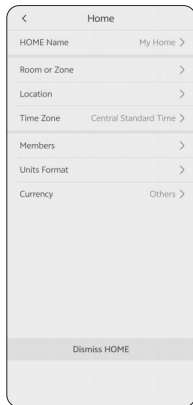
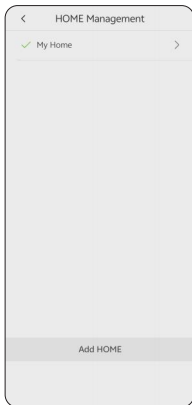
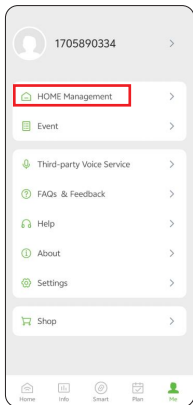

3.12 Google Assistant/Alexa Voice Control

How to get third-party control / voice control?

If you have a **Google Assistant** or **Amazon Alexa**, please tap "**Third-party Voice Service**" in "**Me**" page, and then tap "**Google Assistant**" or "**Amazon Alexa**" to check the operation guide to connect your WiFi water timer to the voice control device. After successfully connecting, you can control the WiFi water timer by voice.

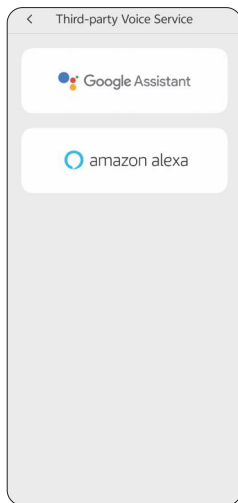
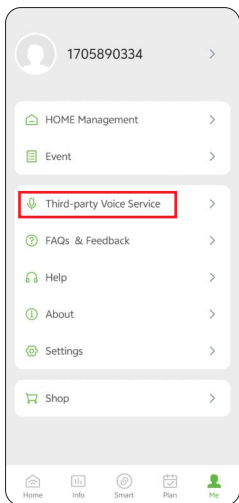



*Please scan the QR code to check the video of how to connect your WiFi water timer to the voice control device.

NOTE: The WiFi water timer can only perform simple voice commands, such as "turn on" or "turn off" and the commands should be **English only**. If you have any questions or suggestions about this feature, please feel free to contact us.

4. RESET THE DEVICE

How to reset the WiFi Gateway?

Power on the gateway with the USB cable. Press and hold the button for 5 seconds until the GREEN LED light flashes quickly.

How to reset the WiFi timer?

Step 1. Remove all batteries from the battery compartment.

Step 2. After 10 seconds, insert 4 fresh AA alkaline batteries into the battery compartment of the timer.

Step 3. While installing the battery, press and hold the button on the timer without releasing the button until the LED indicator flashes RED quickly(2 times per second), then the WiFi timer is restored successfully.

5. THE MEANING OF LED LIGHT

The Meaning of the LED Light of the WiFi Gateway

- 1) **Power On:** Power indicator is always on.
- 2) **When an Ethernet cable is plugged in:** Ethernet indicator begins to flash; it will remain on when the gateway is connected successfully.
- 3) **WiFi pairing mode:** WiFi indicator flashes quickly.
- 4) **Successful WiFi pairing:** WiFi indicator is steady on.
- 5) **Failed pairing:**
 - ① **WiFi pairing mode timeout:** WiFi indicator stops flashing.
 - ② **Ethernet pairing mode timeout:** Ethernet indicator stops flashing.
- 6) **The gateway disconnected from Network:**
 - ① **Disconnected after successful WiFi connection:** WiFi indicator flashes slowly.
 - ② **Disconnected after successful Ethernet connection:** Ethernet indicator flashes slowly.
 - ③ **Disconnected after both WiFi and Ethernet connection:** Both WiFi and Ethernet indicators flash slowly at the same time; after 60 seconds, the Ethernet indicator will flash slowly; after another 60 seconds, the WiFi indicator will blink slowly. This alternation of states will continue every 60 seconds.

The Meaning of the LED Light of the WiFi Timer

- 1) **Short press the button:** Open/close the valve; the white light flashes once.
- 2) **Power on the timer:** Red and white lights turn on simultaneously for 1 second; the red LED blinks rapidly (on for 0.2 seconds, off for 0.2 seconds in a cycle).
- 3) **Network connection indication:** The red LED blinks rapidly (on for 0.2 seconds, off for 0.2 seconds in a cycle); **successful pairing:** white light stays on for 2 seconds; **failed pairing:** red light stays on for 2 seconds.
- 4) **Long press the button to restart and enter pairing mode:** The red indicator light stays on for 2 seconds, then both white and red LEDs illuminate for 1 second, followed by rapid blinking of the red LED to indicate entry into pairing mode.
- 5) **Normal irrigation mode:** The white light flashes once every 4 seconds.
- 6) **Interval irrigation mode:** The white light flashes twice every 4 seconds.
- 7) **Cycle & Soak mode:** When the valve is open, the white light flashes twice every 4 seconds; when the valve is closed (soaking), the white LED flashes once every 10 seconds.
- 8) **Low battery indication:** When in a low battery state, the red LED flashes once every 3 seconds, on for 0.1 seconds.

6. TROUBLESHOOTING

Troubleshooting Of the WiFi Gateway

ISSUE	SOLUTION
<p>The gateway cannot connect.</p>	<ul style="list-style-type: none"> • Confirm that the WiFi password has been entered correctly. • Stay closer to the router when connecting.
<p>Gateway is disconnected or offline.</p>	<ul style="list-style-type: none"> • Please check if the router is functioning properly. • If there was a power outage and then restored, ensure the router is operational; then follow the connection section of this manual to reconnect the gateway. • Check if the WiFi signal is unstable. If the distance between the gateway and router is too far, move the gateway closer to ensure a more stable connection.
<p>The gateway button is unresponsive.</p>	<p>Please contact our customer service department for assistance.</p>
<p>Ethernet indicator light does not flash.</p>	<ul style="list-style-type: none"> • Please disconnect the power and plug it back in. • Please check if the network cable is securely plugged in.

Troubleshooting Of the WiFi Timer

ISSUE	POSSIBLE CAUSE	SOLUTION
Unable to open the valve.	<ul style="list-style-type: none"> • Low battery. • Debris in the inlet. • Unstable network or response delay. 	<ul style="list-style-type: none"> • Replace with new batteries. • Regularly clean the debris in the filter to avoid interference with use. • Wait a moment and try opening the valve again.
Flow meter is inaccurate.	<ul style="list-style-type: none"> • Data is inaccurate due to an angled installation. • Low or unstable water pressure from the faucet. 	<ul style="list-style-type: none"> • The water timer should be installed vertically to the ground; it is recommended not to install it at any angle to avoid affecting the water volume recording. • The normal error value for water counting is $\pm 5\%$.
Timer cannot connect.	<ul style="list-style-type: none"> • WiFi network is unstable. • Too far from the gateway. • Timer is not in pairing mode. 	<ul style="list-style-type: none"> • Please check whether the WiFi network environment is functioning properly. • When connecting to the irrigation timer, stay close to the gateway and router. • Re-pair the timer: press and hold the timer button until the red light flashes quickly, indicating pairing (or remove the device from the homepage and reconnect).
Not executing as scheduled.	<ul style="list-style-type: none"> • Impurities in the water have entered the filter. • Rain delay has been set. • In low power mode, the timer enters low power protection mode and does not execute the schedule. 	<ul style="list-style-type: none"> • Impurities in the inlet need to be regularly cleared to prevent them from clogging and interfering with the irrigation program. • Check if the rain delay has been set. • Replace with new batteries.

7. LIMITED WARRANTY

We provide a 12-month limited warranty period for the original purchaser/user, which starts from the date of original purchase. The warranty covers any defect in material or workmanship. During the warranty period, we will fulfill its warranty obligations by repairing or replacing the parts or the entire unit covered by the warranty free of charge according to the actual situation.

However, the warranty does not apply to problems caused by: Normal wear and tear; Failure to follow the accompanying operating instructions; Products malfunction resulting from negligence, accident, improper use, maintenance or storage; Products that have been modified or repaired without authorization (including, but not limited to, modifications through the use of unauthorized parts or accessories).

If you contact us to register the warranty, we'll extend the warranty to 5 YEARS free of charge. To activate and extend the warranty to 5 years, please contact us for warranty registration upon receipt of the package.

8. CUSTOMER SERVICE

If you still having trouble with setup, please search for "**RainPoint**" on YouTube for installation videos!

If the user manual doesn't have what you're looking for or you need assistance, please contact us for help before returning the product to the store.

Our local professional customer service team guarantees hassle-free solutions within 24 hours on working days. If you have any problems with this product or during use, please do not hesitate to contact us, we will try our best to solve it and offer you satisfactory service including replacement or refund.

In order to serve you better, please remember to provide us with your order number, LOT NO. of your device and fault description of the product and contact us by:

US toll free: +1 833-381-5659(Mon-Fri: 9:30 AM-5:30 PM PST)

DE toll free: +49 800-182-0576(Mon-Fri: 9:00 AM-5:00 PM CET)

UK toll free: +44 800-808-5337(Mon-Fri: 9:00 AM-5:00 PM CET)

Email: service@rainpointonline.com

WhatsApp: +1 626-780-5952

NOTE: Please note that the app may be updated or modified, which could result in changes to certain pages or names. For the most accurate information, please refer to the actual pages within the app. If you need assistance, please feel free to contact us.

FCC STATEMENT

(FCC ID: 2AWDBHTV245FRF+2AWDBHWG040)

This device complies with Part 15 of the FCC Rules.

Operation is subject to the following two conditions:

- 1) This device may not cause harmful interference.
- 2) This device must accept any interference received, including interference that may cause undesired operation.

FCC Warning: Any changes or modifications not expressly approved by the party responsible for compliance could void the user's authority to operate this equipment.

Note: This equipment has been tested and found to comply with the limits for a Class B digital device, pursuant to Part 15 of the FCC Rules. These limits are designed to provide reasonable protection against harmful interference in a residential installation. This equipment generates, uses, and can radiate radio frequency energy, if not installed and used in accordance with the instructions, may cause harmful interference to radio communications.

However, there is no guarantee that interference will not occur in a particular installation. If this equipment does cause harmful interference to radio or television reception, which can be determined by turning the equipment off and on, the user is encouraged to try to correct the interference by one of the following measures:

- Reorient or relocate the receiving antenna.
- Increase the separation between the equipment and the receiver.
- Connect the equipment into an outlet on a circuit different from that to which the receiver is connected.
- Consult the dealer or an experienced radio/TV technician for help.

Note: The manufacturer is not responsible for any radio or TV interference caused by unauthorized modifications to this equipment. Such modifications could void the user's authority to operate the equipment.

EC REP

NAME: VIAJE ELECTRONIC COMPANY LIMITED

ADDRESS: E588, 13 ADELAIDE ROAD, DUBLIN, D02 P950, IRELAND

EMAIL: VIAJEELE@outlook.com

UK REP

NAME: SUJE ELECTRONIC COMPANY LIMITED

ADDRESS: S211 92a Bury Old Road, Manchester, England, M45 6TQ

EMAIL: SUJEELECTRONIC@outlook.com

Manufacturer/Hersteller/Fabricant/Produttore/Fabricante:

FUJIAN BALDR TECHNOLOGY CO.,LTD

ADDRESS/ADRESSE/ADRESSE/INDIRIZZO/DIRECCIÓN:

Floor 3, Building 2, No.71 Yangqi Road, Fuwan Industrial Area,
Cangshan District, Fuzhou, China. 350008

EMAIL:service@rainpointonline.com

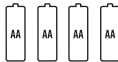

Not included.





Scan the QR code to
get fast support

Need Help?

Please contact us

US toll free: +1 833-381-5659

(Mon-Fri: 9:30 AM-5:30 PM PST)

DE toll free: +49 800-182-0576

(Mon-Fri: 9:00 AM-5:00 PM CET)

UK toll free: +44 800-808-5337

(Mon-Fri: 9:00 AM-5:00 PM CET)

Email: service@rainpointonline.com

WhatsApp: +1 626-780-5952

