

GoveeLife

Model: H7152

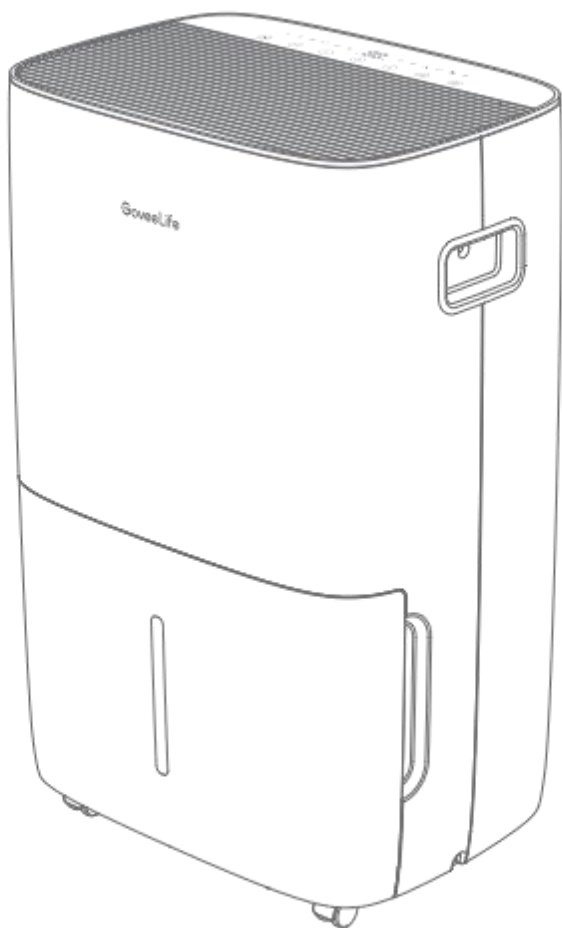

User Manual

Smart Dehumidifier Max (Pump)

contents

READ AND SAVE THESE INSTRUCTIONS	01
Included in the Box	09
Introduction	09
Getting started	14
Govee Home APP	15
using your Dehumidifier	16
care & Maintenance	19
Troubleshooting	20
Appendix	22

GoveeLife Dehumidifier user Manual

READ AND SAVE THESE INSTRUCTIONS

SAFETY WARNINGS

when using the unit, please read the following safety instructions:

- Follow local grid interconnection rules while installing the dehumidifier and ensure that it is properly grounded. If you have any question on electrical installation, follow the instructions of the manufacturer and if necessary, ask a professional electrician to install it.
- place the machine in a flat and dry place and keep a distance of above 50cm between the machine and the surrounding objects or walls.
- when drainage pipes are installed, ensure that the drainage pipes are properly connected, and are not distorted or bended.
- keep the air inlet and outlet free from obstructions.
- That the appliance shall be installed in accordance with national wiring regulations.
- After the dehumidifier is installed, ensure that the power plug is intact and firmly plugged into the power outlet and place the power cord orderly to prevent someone from being tripped or pulling out the plug.
- Do not put any object into the air inlet and outlet of the dehumidifier.
- Maintenance and repair rearing the assistance of other skilled personnel shall be carried out under the supervision of the person competent in the use of lammable refrigerants.
- All working procedure that affects safety means shall only be carried by competent persons.
- The dehumidifier is only suitable for indoor use, and is not suitable for other applications.
- when moving the machine, make sure that it is in an upright position.
- The machine should stay away from gasoline, flammable gas, stoves and other heat sources.
- Don't disassemble, overhaul and modify the machine arbitrarily, otherwise it will cause a machine malfunction or even bring harm to persons and properties. To avoid danger, if a machine failure occurs ask the manufacturer or professionals to repair it.
- Do not pull the plug to turn off the machine.
- Do not place Cups or other objects on the body to prevent water or other liquids from spilling into the dehumidifier.
- Do not use insecticide sprays or other flammable substances near the dehumidifier.
- Do not wipe or wash the dehumidifier with chemical solvents such as gasoline and alcohol. when you need to clean the dehumidifier, you must disconnect the power supply, and clean it with a half-wet softcloth. If the machine is really dirty, scrub with a mild detergent.
- children should be supervised to ensure that they do not play with the appliance. cleaning and maintenance shall not be made by children without supervision.

- o If the supply cord is damaged, it must be replaced by the manufacturer, its service agent or similarly qualified persons in order to avoid a hazard.
- The appliance shall be stored so as to prevent mechanical damage from occurring.
- plug into a grounded 3 prong outlet.
- Do not use an extension cord.
- Do not remove ground prong.
- Do not use an electrical adapter.
- unplug the dehumidifier before servicing.
- The dimensions of the space necessary for correct installation of the appliance including the minimum permissible distances to adjacent structures.
- A Wiring diagram with a clear indication of the connections and wiring to external control devices and SUPPLY CORD.
- This appliance is not intended for use by persons (including children) with reduced physical, sensory or mental capabilities, or lack of experience and knowledge, unless they have been given supervision or instruction concerning use of the appliance by a person responsible for their safety.
- This unit is equipped with electrically powered safety measures. To be effective, the unit must be electrically powered at all times after installation, other than when servicing.

WARNING for using R32 Refrigerant:

Transportation, marking and storage for units that employ flammable refrigerants

1. General

- The following information is provided for units that employ FLAMMABLE REFRIGERANTS.

2. Transport of equipment containing flammable refrigerants

- Attention is drawn to the fact that additional transportation regulations may exist with respect to equipment containing flammable gas. The maximum number of pieces of equipment or the configuration of the equipment permitted to be transported together will be determined by the applicable transport regulations.

3. Marking of equipment using signs

- o signs for similar appliances used in a work area are generally addressed by local regulations and give the minimum requirements for the provision of safety and/or health signs for a work location.
- All required signs are to be maintained and employers should ensure that employees receive suitable and sufficient instruction and training on the meaning of appropriate safety signs and the actions that need to be taken in connection with these signs.
- The effectiveness of signs should not be diminished by too many signs being placed together.
- Any pictograms used should be as simple as possible and contain only essential details.

4. Disposal of equipment using flammable refrigerants

- o see national regulations.

5. storage of equipment/appliances

- The storage of the appliance should be in accordance with the applicable regulations or instructions, whichever is more stringent.

6. storage of packed (unsold) equipment

- o storage package protection should be constructed such that mechanical damage to the equipment inside the package will not cause a leak of the refrigerant charge.
- The maximum number of pieces of equipment permitted to be stored together will be determined by local regulations.

7. Important instruction

7.1 Qualification of workers

- The manual shall contain specific information about the required qualification of the working personnel for maintenance, service and repair operations. Every working procedure that affects safety means shall only be carried out by competent persons.
- Examples for such working procedures are:
 - breaking into the refrigerating circuit;
 - opening of sealed components;
 - opening of ventilated enclosures.

Information on servicing:

1. General

- The manual shall contain specific information for service personnel according.

2. checks to the area

- prior to beginning work on systems containing FLAMMABLE REFRIGERANTS, safety checks are necessary to ensure that the risk of ignition is minimised. For repair to the REFRIGERATING SYSTEM.

3. work procedure

- work shall be undertaken under a controlled procedure so as to minimise the risk of a flammable gas or vapour being present while the work is being performed.

4. General work area

- All maintenance staff and others working in the local area shall be instructed on the nature of work being carried out. work in confined spaces shall be avoided.

5. checking for presence of refrigerant

- The area shall be checked with an appropriate refrigerant detector prior to and during work, to ensure the technician is aware of potentially toxic or flammable atmospheres. Ensure that the leak detection equipment being used is suitable for use with all applicable refrigerants, i. e. non-sparking, adequately sealed or intrinsically safe.

6. presence of fire extinguisher

- If any hot work is to be conducted on the refrigerating equipment or any associated parts, appropriate fire extinguishing equipment shall be available to hand. Have a drypowder or Co2, fire extinguisher adjacent to the charging area.

7. No ignition sources

- No person carrying out work in relation to a REFRIGERATING SYSTEM Which involves exposing any pipe work shall use any sources of ignition in such a manner that it may lead to the risk of fire or explosion. All possible ignition sources, including cigarette smoking, should be kept sufficiently far away from the site of installation, repairing, removing and disposal, during which refrigerant can possibly be released to the surrounding space. prior to work taking place, the area around the equipment is to be surveyed to make sure that there are no flammable hazards or ignition risks. "No smoking" signs shall be displayed.

8. ventilated area

- Ensure that the area is in the open or that it is adequately ventilated before breaking into the system or conducting any hot work. A degree of ventilation shall continue during the period that the work is carried out. The ventilation should safely disperse any released refrigerant and preferably expel it externally into the atmosphere.

9. checks to the refrigerating equipment

- where electrical components are being changed, they shall be fit for the purpose and to the correct specification. At all times the manufacturer's maintenance and service guidelines shall be followed. If in doubt, consult the manufacturer's technical department for assistance.
- The following checks shall be applied to installations using flammable refrigerants.
 - the actual REFRIGERANT CHARGE is in accordance with the room size within which the refrigerant containing parts are installed;
 - the ventilation machinery and outlets are operating adequately and are not obstructed;
 - if an indirect refrigerating circuit is being used, the secondary circuit shall be checked for the presence of refrigerant;
 - marking to the equipment continues to be visible and legible. Markings and signs that are illegible shall be corrected;
 - refrigerating pipe or components are installed in a position where they are unlikely

to be exposed to any substance which may corrode refrigerant containing components, unless the components are constructed of materials which are inherently resistant to being corroded or are suitably protected against being so corroded.

10. checks to electrical devices

- Repair and maintenance to electrical components shall include initial safety checks and component inspection procedures. If a fault exists that could compromise safety, then no electrical supply shall be connected to the circuit until it is satisfactorily dealt with. If the fault cannot be corrected immediately but it is necessary to continue operation, an adequate temporary solution shall be used. This shall be reported to the owner of the equipment so all parties are advised.
- Initial safety checks shall include :
 - that capacitors are discharged: this shall be done in a safe manner to avoid possibility of sparking;
 - that no live electrical components and wiring are exposed while charging, recovering or purging the system;
 - that there is continuity of earth bonding.

11. Repairs to sealed components

- sealed electrical components shall be replaced.

12. Repair to intrinsically safe component

- Intrinsically safe components must be replaced.

13. cabling

- check that cabling will not be subject to wear, corrosion, excessive pressure, vibration, sharp edges or any other adverse environmental effects. The check shall also take into account the effects of aging or continual vibration from sources such as compressors or fans.

14. Detection of flammable refrigerants

- under no circumstances shall potential sources of ignition be used in the searching for or detection of refrigerant leaks. A halide torch (or any other detector using naked flame) shall not be used.
- The following leak detection methods are deemed acceptable for all refrigerant systems.
- Electronic leak detectors may be used to detect refrigerant leaks but, in the case of FLAMMABLE REFRIGERANTS, the sensitivity may not be adequate, or may need re-calibration. (Detection equipment shall be calibrated in a refrigerant-free area.) Ensure that the detector is not a potential source of ignition and is suitable for the refrigerant used. Leak detection equipment shall be set at a percentage of the LFL of the refrigerant and shall be calibrated to the refrigerant employed, and the

appropriate percentage of gas(25 % maximum) is confirmed.

- o Leak detection fluids are also suitable for use with most refrigerants but the use of detergents containing chlorine shall be avoided as the chlorine may react with the refrigerant and corrode the copper pipe-work.
- NOTE Examples of leak detection fluids are:
 - bubble method.
 - fluorescent method agents.
- o If a leak is suspected, all naked flames shall be removed/extinguished.
- o If a leakage of refrigerant is found which requires brazing, all of the refrigerant shall be recovered from the system, or isolated (by means of shut off valves) in a part of the system remote from the leak.

15. Removal and evacuation

- o conventional procedures shall be used. However, for flammable refrigerants it is important that best practice be followed, since flammability is a consideration.
- The following procedure shall be adhered to:
 - safely remove refrigerant following **local** and national regulations;
 - evacuate;
 - purge the circuit with inert gas(optional for A2L),
 - evacuate(optional for A2L);
 - continuously flush or purge with inert gas when using flame to open circuit ;and
 - open the circuit.
- The refrigerant charge shall be recovered into the correct recovery cylinders if venting **is** not allowed by local and national codes. For appliances containing flammable refrigerants, the system shall be purged with oxygen-free nitrogen to render the appliance safe for flammable refrigerants. This process might need to be repeated several times. compressed air or oxygen shall not be used for purging refrigerant systems.
- For appliances containing flammable refrigerants, refrigerants purging shall be achieved by breaking the vacuum in the system with oxygen-free nitrogen and continuing to fill until the working pressure is achieved, then venting to atmosphere, and finally pulling down to a vacuum (optional for A2L). This process shall be repeated until no refrigerant is within the system (optional for A2L). when the final oxygen-free nitrogen charge is used, the system shall be vented down to atmospheric pressure to enable work to take place.
- The outlet for the vacuum pump shall not be close to any potential **ignition** sources .and ventilation shall be available.

16 . charging procedures

- o In addition to conventional charging procedures, the following requirements shall be followed.

- Ensure that contamination of different refrigerants does not occur when using charging equipment. Hoses or lines shall be as short as possible to minimise the amount of refrigerant contained in them .
- cylinders shall be kept in an appropriate position according to the instructions.
- Ensure that the REFRIGERATING SYSTEM is earthed prior to charging the system with refrigerant.
- Label the system when charging is complete (if not already) .
- Extreme care shall be taken not to overfill the REFRIGERATING SYSTEM .
- prior to recharging the system , it shall be pressure-tested with the appropriate purging gas. The system shall be leak-tested on completion of charging but prior to commissioning. A follow Up leak test shall be carried out prior to leaving the site.

17. Decommissioning

- Before carrying out this procedure, it is essential that the technician is completely familiar with the equipment and all its detail . it is recommended good practice that all refrigerants are recovered safely. prior to the task being carried out, an oil and refrigerant sample shall be taken in case analysis is required prior to re-use of recovered refrigerant. It is essential that electrical power is available before the task is commenced .
 - a) Become familiar with the equipment and its operation.
 - b) **Isolate** system electrically.
 - c) Before attempting the procedure, ensure that:
 - mechanical handling equipment is available, if required, for handling refrigerant cylinders;
 - all personal protective equipment is available and being used correctly;
 - the recovery process is supervised at all times by a competent person;
 - recovery equipment and cylinders conform to the appropriate standards.
 - d) pump down refrigerant system , if possible.
 - e) If a vacuum is not possible, make a manifold so that refrigerant can be removed from various parts of the system.
 - f) Make sure that cylinder is situated on the scales before recovery takes place.
 - g) start the recovery machine and operate in accordance with instructions.
 - h) Do not overfill cylinders (no more than 80 % volume liquid charge) .
 - i) Do not exceed the maximum working pressure of the cylinder, even temporarily.
 - j) when the cylinders have been filled correctly and the process completed make sure that the cylinders and the equipment are removed from site promptly and all isolation valves on the equipment are closed off.
 - k) Recovered refrigerant shall not be charged into another REFRIGERATING SYSTEM unless it has been cleaned and checked.

18. Labelling

- Equipment shall be labelled stating that it has been de-commissioned and emptied

of refrigerant. The label shall be dated and signed. For appliances containing FLAMMABLE REFRIGERANTS, ensure that there are labels on the equipment stating the equipment contains FLAMMABLE REFRIGERANT.

19. Recovery

- when removing refrigerant from a system, either for servicing or decommissioning, it is recommended good practice that all refrigerants are removed safely.
- when transferring refrigerant into cylinders, ensure that only appropriate refrigerant recovery cylinders are employed. Ensure that the correct number of cylinders for holding the total system charge is available. All cylinders to be used are designated for the recovered refrigerant and labelled for that refrigerant (i. e. special cylinders for the recovery of refrigerant). Cylinders shall be complete with pressure-relief valve and associated shut-off valves in good working order. Empty recovery cylinders are evacuated and, if possible, cooled before recovery occurs.
- The recovery equipment shall be in good working order with a set of instructions concerning the equipment that is at hand and shall be suitable for the recovery of the flammable refrigerant. If in doubt, the manufacturer should be consulted. In addition, a set of calibrated weighing scales shall be available and in good working order. Hoses shall be complete with leak-free disconnect couplings and in good condition.
- The recovered refrigerant shall be processed according to local legislation in the correct recovery cylinder, and the relevant waste transfer note arranged. Do not mix refrigerants in recovery units and especially not in cylinders.

WARNING

- Do not use means to accelerate the defrosting process or to clean, other than those recommended by the manufacturer.
- The appliance shall be stored in a room without continuously operating ignition sources (for example, open flames, an operating gas appliance or an operating electric heater)
- Do not pierce or burn.
- Be aware that refrigerants may not contain an odour.



Appliance filled
with flammable gas
as R32.



Included in the Box

Item	Quantity
Dehumidifier	1
Drain Hose	1
Hose Adapter	1
User Manual	1
Quick Start Guide	1

Introduction

Part Names

- a. Display Panel
- b. Touch Control Panel
- c. Air Outlet Grille
- d. Built-in Handle (Both Sides)
- e. Transfer Tank
- f. Bucket Handle (Both Sides)
- g. Universal Caster
- h. Water Level Window
- i. Water Bucket
- j. Air Intake Grille
- k. Air Filter (Over the Grille)
- l. Drain Outlet Cap
- m. Cable Clip
- n. Power Cord
- o. Power Plug
- p. Plug Holder

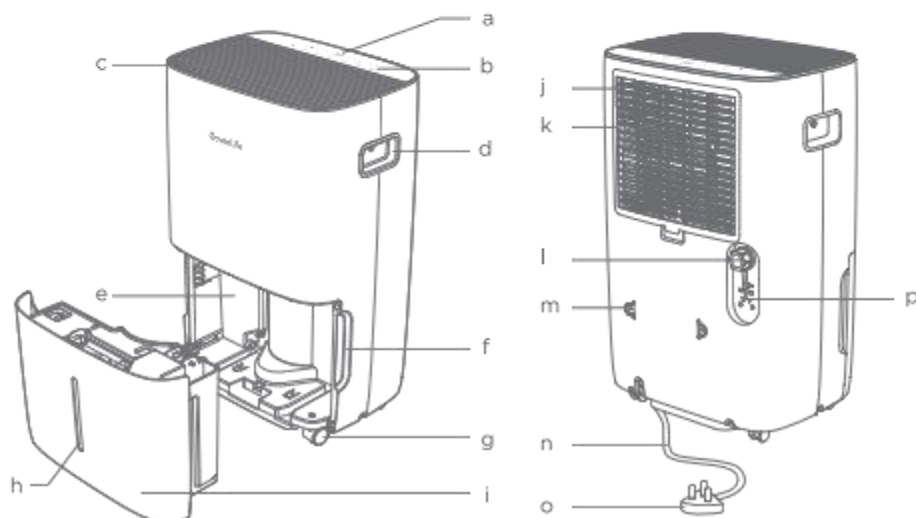

- q. Internal Drip Tray
- r. Water Tank Cover
- s. Water Tank Handle
- t. Hose Adapter
- u. Hose Detection Switch

- v. Continuous Drain Hose Outlet
- w. Drain Outlet Cap
- x. Drain Hose
- y. Float

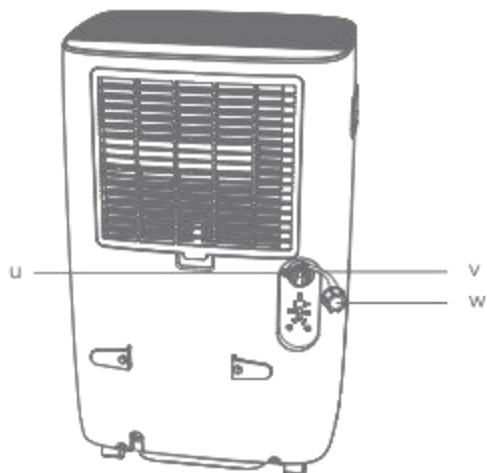
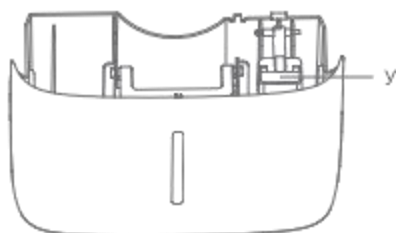
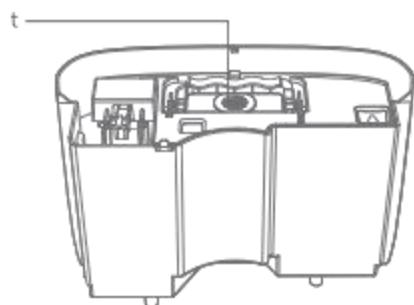
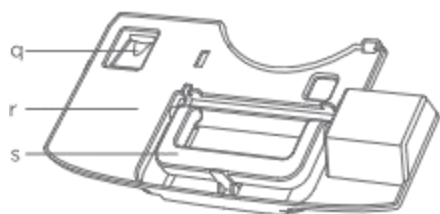

controls & Functions

You can access additional features using Govee Home APP.



power Button

Touch to turn the dehumidifier on or off.

Note :

- when powering the dehumidifier on or off, the compressor will respond with a short vibration .
- Follow the in-app instructions to press the power button when pairing with the app.



speed Button

Touch to cycle through Low (I), Medium (II), High (111) speed. At high speed, the dehumidifier reduces moisture and dampness to a maximum extent. when the humidity has been lowered, switch to **low** speed to let the dehumidifier run quietly.

Note: In speed Mode, the dehumidifier continuously reduces the moisture. If you wish to stop dehumidifying when your room humidity reaches the target value, touch the Mode Button to turn on Auto Mode.



Mode Button

Touch to switch between Auto Mode and Laundry Drying Mode.

Auto Mode: The dehumidifier automatically turns on or off and adjusts its speed based on the current humidity. In this mode, touch **+** or **-** to increase or decrease the current ambient humidity value displayed on the panel to set your target humidity by 5% within the range between 30% to 80%. After you finish adjusting the target value, wait for 5 seconds for the setting to take effect.

Note:



1. The setting of target humidity only works in Auto Mode.
2. The fans will continue working for 3 more minutes when the target humidity is reached to dry the condensed water inside and prolong the lifespan of the dehumidifier.

Laundry Drying Mode: The dehumidifier continuously operates at high speed with lower running costs compared to a conventional tumble dryer.

Note: In Auto Mode and Laundry Drying Mode, the speed cannot be manually adjusted.



Timer Button

Timer: Touch to set a timer and touch  or  to increase or decrease the time by 1 hour. After you finish setting the time, wait for 5 seconds for the timer to work. Read the countdown by hour on the display panel and check any remaining time on the app.



Touch LoCK

LoCK: Long press for 3 seconds to turn the touch lock on or off.

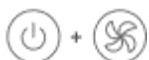

Recovery Button

Long press for 5 seconds until all indicators flash once, then the dehumidifier will be restored to factory settings, disconnect from wi-Fi and Bluetooth, and automatically reboot. This button is for restoring all preset functions if the dehumidifier cannot function properly.

Note: After restoring the dehumidifier to factory settings, go to the "Device" page on the app to delete this dehumidifier first, otherwise it cannot be added to the app again.

pump Draining Function

When a hose is connected and detected by the dehumidifier (refer to "using your Dehumidifier - pump Draining" for more information), the pump feature will activate automatically and the indicator will **light** up. After collecting a certain amount of condensate, the pump will drain the collected water and stop collecting condensate through the water tank.

Memory Function

The dehumidifier will save its previous settings when powered off (such as its speed, mode, and wi-Fi connection). When it is powered back on, the settings will resume.











compressor protection for 3 Minutes Before start-Up

After the dehumidifier has stopped, it cannot be restarted to dehumidify in the first 3 minutes in order to protect its compressor and expand its lifespan. It will automatically restart after 3 minutes.

compressor protection for 8 Hours of continuous operation

After 8 hours of continuous dehumidification, the compressor will automatically stop running for 8 minutes without notice. Nothing needs to be done to release this action. After the fans have worked for 8 minutes, the compressor will restart.

Indicator status

Indicator	working status	Light status
	powered on	solid white
I	continuous Dehumidification at Low speed	solid white
II	continuous Dehumidification at Medium speed	solid white
	continuous Dehumidification at High speed	solid white
	Auto Mode	solid white
	Laundry Drying Mode	solid white
	Timer	solid white
	Locked	solid white
	unlocked	Dim
	Lock Reminder	Triple Flashes
	pump Enabled	solid white
	pump Malfunction	slow Flash
	Auto Defrost	solid Red
	water Bucket is Full	solid Red
	Full Reminder	Triple Flashes
	Humidity value	solid white
	Hour	solid white
	current value	solid white
	Last stage setting	slowly Flashes
	Ready for connecting	slowly Flashes white
	connecting	Quickly Flashes white
	connected	solid white
	Not connected	Dim

Note :

1. The bucket indicator will also light up when the bucket is pulled out. You can go to "Device settings" page to turn on "Full Bucket Alert", then you will get notifications from the app when the bucket is full of water or is being pulled out.
2. If the dehumidifier detects internal frosting, it will automatically trigger Auto Defrost until there is no frost. In Auto Defrost mode, the dehumidifier will stop dehumidifying.

Getting Started

Before getting started, leave the dehumidifier to stand upright for 24 HOURS so the oil in the compressor can settle from the move since the dehumidifier may have been tilted or placed upside down during shipping, otherwise this will affect the performance or lifespan of the dehumidifier.

1. Place the dehumidifier on a smooth level floor strong enough to support the unit with a full bucket of water.

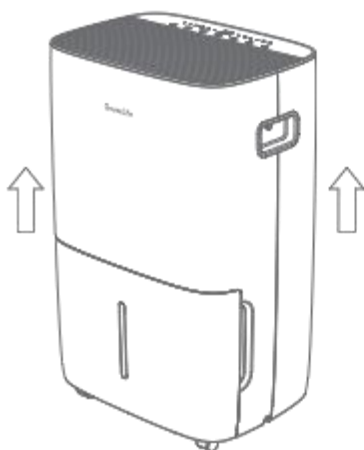

2. Allow at least 8 inches of air space on all sides of the unit for air circulation (at least 16 inches for air outlet). Place the product away from any clothes dryer, heater or radiator.

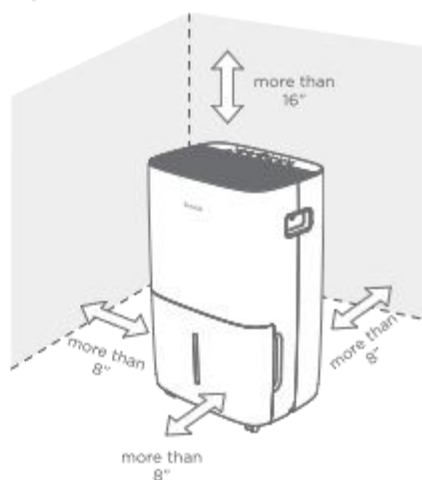

3. Plug the dehumidifier into a 120 V socket. Now your Smart Dehumidifier is ready to use!

Note:

1. Place the dehumidifier in places where the temperature will not fall below 41°F (5°C) since its coil may frost in low temperatures and affect the performance.
2. Close all doors, windows, and other openings to the room when using the dehumidifier so as to achieve the best performance.

Govee Home APP

You can access more features using Govee Home APP.

Downloading Govee Home APP

To download Govee Home APP, scan the QR Code or search for "Govee" in the APP store (ios) or Google play store (Android).



Govee Home APP



Note :

- choose "Allow" to the permissions requested when opening Govee Home APP for the first time. These permissions allow the app's features to function normally and are not used to record personal or private information.
- Due to ongoing updates, Govee Home APP may be slightly different than shown in this manual. In case of any differences, always follow the in-app instructions.

pairing with Govee Home APP

1. Turn on your smartphone's Bluetooth. connect to your wi-Fi router's 2.4GHz network. 5GHz is not supported.
2. Android users turn on Location services; ios users choose Location ->Always on in the pop-up window while adding devices.

Note :

- For ios users, if you chose Location->Never, it might result in notifications/alert exceptions. It is recommended to follow settings ->Govee Home ->Location ->Always on to obtain the best experience.
 - Govee Home WILL NOT Collect, use, or share your location in any way.
3. open Govee Home APP, tap the "+" icon in the top right corner and search for "H7152.
 4. Tap the device icon and follow the in-app instructions to complete the Bluetooth and wi-Fi connection.

Note :

- Method to turn off Bluetooth and wi-Fi connection: press and hold the power Button and speed Button for 5s to restore the device to factory settings, then go to the "Device" page on the app to delete this dehumidifier first, otherwise it cannot be added to the app again.
- You can use Govee Home APP to connect your dehumidifier to Amazon Alexa or Google Assistant. Follow the in-app instructions to connect to each voice assistant.
- Govee Home APP is being continually updated and its features expanded.

Using Your Dehumidifier

Empty the Bucket

The bucket indicator will light up when the water bucket is full and the dehumidifier will automatically shut down until the bucket has been emptied and secured back in place.

1. When the bucket indicator is on, slowly pull out the bucket. Grip the left and right handles securely, and carefully pull out straight to prevent the water from spilling out. Do not put the bucket on any surface because the bottom of the bucket is uneven, otherwise this may spill the water.

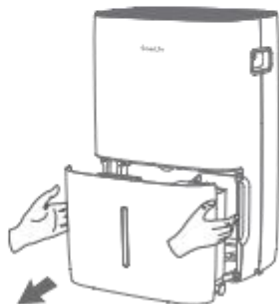

2. Invert the bucket to empty the water.



3. The bucket indicator will go out when the bucket is put back in place and the dehumidifier will start working again.

Note:

1. Do not pull the bucket out when it is not full because when the dehumidifier stops working, it will still drip some water, which may wet the floor or cause danger. If you still want to pull it out, wait for several minutes after the dehumidifier is turned off.
2. Do not remove the float from the water bucket, otherwise the water level cannot be properly detected and will cause overflow.
3. When putting the water bucket back, ensure that it is properly placed to avoid overflow.

Drying Clothes

Turn on Laundry Drying Mode to dry your clothes faster and efficiently especially during the humid weather seasons.

Step 1: Keep the dehumidifier away from the water dripping from the washed clothes.

Step 2: Turn on the dehumidifier and choose Laundry Drying Mode, and direct the air outlet towards the clothes.

Note: The drying effect varies from the thickness, the amount of clothes, and the size of the drying space. Theoretically, the effect will be better when clothes are few, thin, and the space is small. The drying process should take 3-8 hours.

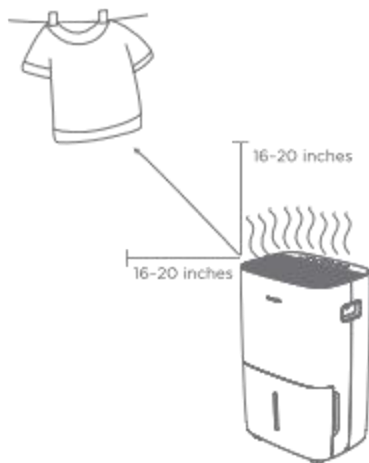

Pump Draining

When a hose is connected and detected by the dehumidifier, the pump feature will activate automatically and the indicator will light up. After collecting a certain amount of condensate, the pump will drain the collected water and stop collecting condensate through the water tank.

Using the included hose:

1. Take the hose adapter away from the water tank cover.

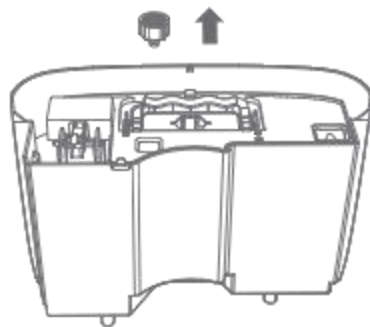

2. Unscrew the cap on the back of the product to access the hose adapter.

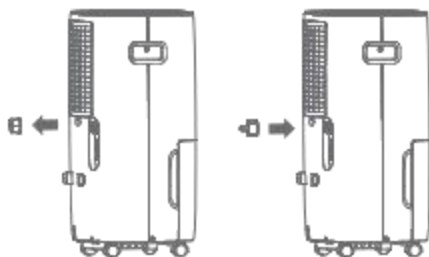

3. Thread the drain hose (included) onto the hose adapter, leading to a floor drain.

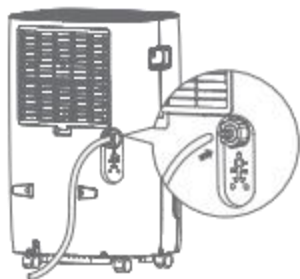

Note:

1. Ensure that the connection is tight and there is no leaking.
2. Avoid kinks and bends in the hose.
3. When the dehumidifier is not continuously draining, remove the hose from the outlet, dry the outlet and screw the drain outlet cap on tightly.

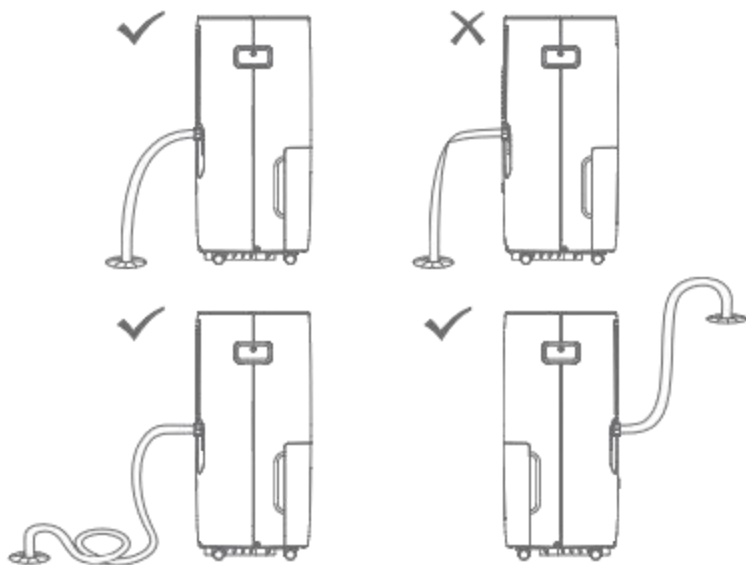

Care & Maintenance

Note: Before cleaning, turn the dehumidifier off and unplug it from power.

Cleaning

1. Grille and Case

- Use a soft damp cloth to clean. Do not splash water directly into the unit, otherwise this may cause an electrical shock, deteriorate the insulation, or rust the grille or the case.
- Use water and a mild detergent. Do not use bleach or abrasives.
- The air intake and outlet may get dirty during operation, use a vacuum cleaner or a brush to clean.

2. Bucket

- Clean the bucket thoroughly every few weeks to prevent the growth of mold, mildew, and bacteria.
- Fill half of the bucket with clean water and mild detergent, swirl them around, pour out, and rinse the bucket out.

3. Air Filter

- Pull the filter outwards to remove it.
- Use a vacuum cleaner to gently suck the dust on the surface of the filter. If the filter is very dirty, wipe it with warm water and a gentle cleaner and dry it completely.
- Insert the filter back into the dehumidifier.

Note: Do not operate the dehumidifier without the filter, otherwise this may reduce the performance and damage the dehumidifier.

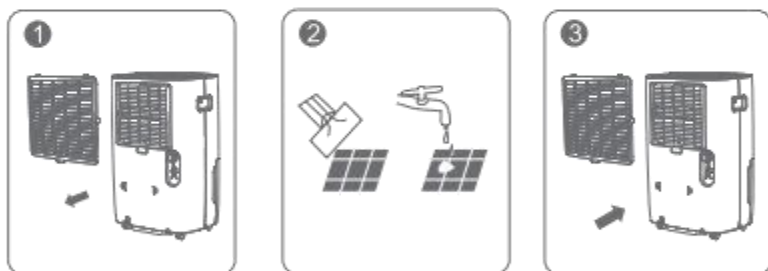

Maintenance

When not using the dehumidifier for a long period of time:

- Let it rest for a whole day to naturally dry out before storing.
- Clean the body, water bucket, and air filter.
- Wrap the cord with the cable clip.
- Put the power plug into the plug holder.
- Cover the dehumidifier with a plastic bag.
- Store it upright in a dry well-ventilated area.

Troubleshooting

The troubleshooting section below is for solving frequently asked Questions. If your problem persists, please contact customer support.

For Dehumidifier

problem	possible solution & Reason
The dehumidifier does not work.	check if the power plug is firmly connected into the wall outlet.
	check the house fuse/circuit breaker box.
	The dehumidifier has reached target temperature in Auto Mode or the water bucket is already full .
	The float in the tank is stuck and is not properly positioned. push the float down to the lowest position.
The drain hose is leaking water when the dehumidifier is continuously draining.	water bucket is not in the proper position , put it back in place.
	The drain hose is not connected correctly or the other end of the drain hose is blocked, so the water cannot be appropriately discharged.
The dehumidifier does not dry the air as it should .	Ensure that both ends of the drain hose are unimpeded after connecting the water pipe to the drain outlet. keeping the drain hose in an inclined state is more conducive to gravity drainage.
	The time is not enough to remove the moisture.
	The ambient humidity is too low, affecting the performance of dehumidifying.
	Make sure there are no curtains, blinds or furniture blocking the top or back of the dehumidifier.
	The dehumidifier is in Auto Mode and its target humidity is higher than the ambient humidity.
	check if all doors, windows, and other openings are securely closed.
	Room temperature is too low , below 41°F (5. c). Heat up the room .
	There is a water vapor source in the room such as a humidifier.
The air filter is dirty. clean the air filter.	
The dehumidifier makes a loud noise when running.	The air filter may be dirty. Follow the previous instruction to clean it.
	The dehumidifier is tilted. put it upright.
	The floor surface is not level .
	check if the filter is properly positioned.



pump indicator doesn't light up after connecting the hose.	check that the hose adapter is properly screwed in. Take it out, and screw it in again. Make sure the hose detection switch is in contact with the water hose adapter.
pump indicator flashes.	check for bends in the hose and smooth it out.
Frost appears on the coils.	This is a normal phenomenon when the dehumidifier is running at low ambient temperature.
	The dehumidifier will automatically start defrosting, and the whole process may take 15 to 20 minutes. when the dehumidifier completes defrosting, it will automatically restart dehumidifying.
water on floor.	The hose port may be loose.
	intended to use the bucket to collect water, but the back drain outlet cover is not in place.
The dehumidifier produces a strange noise when it is turned on.	The refrigerant may not be stable yet. keep the device working for an hour and observe whether the strange noise has disappeared.
Displays error code "E1" or "E2."	please contact customer service for assistance.
Displays "--", instead of the current humidity level.	

For APP & connectivity

1. cannot connect to Govee Home APP.

- Make sure your smartphone is powered on and is not connected with other Bluetooth devices.
 - Enable the smartphone's Location services.
 - Try connecting with another smartphone.
 - Make sure your app is updated to the latest version.
 - Make sure you connect to your wi-Fi router's 2.4GHz network and that the network is working correctly.
 - Make sure the wi-Fi password you entered is correct.
- o shorten the distance between the dehumidifier, wi-Fi router, and the smartphone.
- Make sure your dehumidifier and the wi-Fi router are located away from appliances that produce electromagnetic radiation (e.g. microwave ovens, refrigerators, etc.)
- o If you are using a VPN, try turning it off and then connecting the dehumidifier.
- Disable portal authentication for your wi-Fi network. If portal authentication is enabled, this dehumidifier will not be able to access your wi-Fi network and setup will fail.

portal authentication means that you need to sign in to your wi-Fi network through a web page before you can use the Internet.

2. cannot find the device on Bluetooth Device Nearby page of the app.
 - The dehumidifier may be connected with another smartphone. Disconnect it from the other smartphone first.
3. The dehumidifier is offline.
 - Make sure the dehumidifier is plugged in and powered on, then refresh "Device" in Govee Home APP by swiping down on the screen .
 - Make sure your router is connected to the internet and your smartphone's network connection is working.
 - If the wi-Fi password has been changed, the dehumidifier will automatically go offl ine. Try connecting it to the network again.
 - Delete the offl ine dehumidifier from Govee Home APP, then add and reconfigure the dehumidifier again in the app.

Appendix

customer service

 warranty: 12-Month Limited warranty

 support: Lifetime Technical support

 Email: support@govee.com

 official website: [Www.govee.com](http://www.govee.com)

 @GOVEE  OGoveelife.official

 @GoveeLife  @Goveelife  @GoveeLife

specifications

power source	115V AC 60Hz
Rated power	860W
Rated current	7.5A
operating conditions	Temperature: 41 °F - 86 °F (5 °C - 30 °C)
	Humidity: <80%RH
Noise Level	≤ 53 dB(A)
Moisture Removal (65 °F, 60%RH)	49.72 pints/Day
Moisture Removal (80 °F, 60%RH)	66 pints/Day
Moisture Removal (86 °F, 80%RH)	109 pints/Day
Input power (65 °F, 60%RH)	510W

Input current (65. F, 60%RH)	4.63A
IEF (65. F, 60%RH)	1.90 liters/kwh
Motor FLA	0.58A
Motor compressor	RLA: 4.3A LRA: 24.9A
Refrigerant	R32/150g (5.3ozs)
Maximum allowable pressure	3.72Mpa
Maximum operating pressure High	3.72Mpa
Maximum operating pressure Low	2.07Mpa
unit Dimensions	15x11.3x24.4 inches/38.1x28.7x62 cm
unit weight	40 lb / 18.2 kg

compliance Information

FCC Statement

This device complies with part 15 of the FCC Rules.

operation is subject to the following two conditions: (1) this device may not cause harmful interference, and (2) this device must accept any interference received, including interference that may cause undesired operation.

warning: Any changes or modifications not expressly approved by the party responsible for compliance could void the user's authority to operate the equipment.

Note: This equipment has been tested and found to comply with the limits for a class B digital device, pursuant to part 15 of the FCC Rules. These limits are designed to provide reasonable protection against harmful interference in a residential installation.

This equipment generates uses and can radiate radio frequency energy and, if not installed and used in accordance with the instructions, may cause harmful interference to radio communications. However, there is no guarantee that interference will not occur in a particular installation. If this equipment does cause harmful interference to radio or television reception, which can be determined by turning the equipment off and on, the user is encouraged to try to correct the interference by one or more of the following measures:

- (1) Reorient or relocate the receiving antenna.
- (2) Increase the separation between the equipment and receiver.
- (3) connect the equipment into an outlet on a circuit different from that to which the receiver is connected.
- (4) consult the dealer or an experienced radio/TV technician for help.

FCC Radio Frequency Exposure statement

The device has been evaluated to meet general RF exposure requirements. The device can be used in fixed/mobile exposure condition. The min separation distance is 20cm.

The following importer is the responsible party
Name: GOVEE MOMENTS (US) TRADING LIMITED
Address: 2501 chatham Rd suite R Springfield IL 62704
Email: support@govee.com
contact information: <https://www.govee.com/support>

RF exposure statement

This equipment meets the exemption from the routine evaluation limits in section 2.5 of RSS-102. It should be installed and operated with a minimum distance of 20cm between the radiator and any part of your body.

cet équipement est conforme à l'exemption des limites d'évaluation habituelle de la section 2.5 de la norme RSS-102. Il doit être installé et utilisé à une distance minimale de 20 cm entre le radiateur et toute partie de votre corps.



FOR INDOOR USE ONLY

The Bluetooth® word mark and logos are registered trademarks owned by Bluetooth SIG, Inc. and any use of such marks by shenzhen Qianyan Technology LTD is under license.

The trademark GoveeLife has been authorised to shenzhen Qianyan Technology LTD. copyright ©2021 shenzhen Qianyan Technology LTD. All Rights Reserved.



Govee Home APP

For FAQs and more information ,
please visit: [Www.9ovee.com](http://www.govee.com)